

EN

User manual

Gas hob

USER MANUAL

ZGL62IT

GB

la vita è bella
ZANUSSI

ITALIAN SINCE 1916

Contents

Safety information	2	Care and cleaning	9
Installation	4	What to do if... ..	9
Product description	7	Technical data	10
Operation	8	Environment concerns	11
Helpful hints and tips	8		

Subject to change without notice



Safety information



Warning! These instructions are only valid in the countries whose symbols appear on this booklet's cover.



For your safety and correct operation of the appliance, read this manual carefully before installation and use. Always keep these instructions with the appliance even if you move or sell it. Users must fully know the operation and safety features of the appliance.

General safety



Warning! Persons (including children) with reduced physical sensory, mental capabilities or lack of experience and knowledge must not use the appliance. They must have supervision or instruction for the operation of the appliance by a person responsible for their safety.

Child safety

- Only adults can use this appliance. Children must get supervision to make sure that they do not play with the appliance.
- Keep all packaging away from children. There is a risk of suffocation and physical injury.
- Keep children away from the appliance during and after the operation, until the appliance is cold.

Use

- Remove all packaging, stickers and the protective layer of the stainless steel hob panel (if present) from the appliance before first use. Do not remove the rating plate. It can invalidate the guarantee.
- Set the cooking zones to the "off" position after each use.
- Burners and accessible part become hot during and after use. Do not put cutlery or saucepan lids on the cooking surface. Cookware and its contents can tip over. There is the risk of burns.

- Too hot fats and oils can ignite very quickly. There is the risk of fire.
- Do not leave the appliance unattended during operation.
- Always monitor the appliance during operation.
- Do not let the liquids overflow into the holes of the top of the hob
- Do not use the hob without cookware.
- The appliance is only for domestic use. Do not use the appliance for commercial and industrial use.
- Only use the appliance for domestic cooking tasks. This is to prevent physical injury to persons or prevent damage to property.
- Use only cookware with diameter applicable to the dimensions of burners. There is a risk of overheating and rupture of the glass plate (if applicable).
- Do not use a pan with diameter smaller than burner dimension - flames will heat up the pan handle.
- Pots must not enter the control zone.
- Do not use not stable cookware to prevent from tilt and accident.
- Do not put flammable products or items that are wet with flammable products, and/or fusible objects (made of plastic or aluminium) and/or fabrics in, near or on the appliance. There is the risk of explosion or fire.
- Use only the accessories supplied with appliance.
- Be careful when you connect the appliance to the near sockets. Do not let electricity bonds touch the appliance or hot cookware. Do not let electricity bonds tangle.

Installation

- **You must read these instructions. The manufacturer is not responsible for any injury to persons and pets or**

damage to property caused by failure to obey these requirements.

- **To prevent the risks of structural damage or physical injury, installation, connection of the appliance to the power supply and gas system, setting up and maintenance must only be done by qualified personnel in compliance with standards and local regulation force.**
- Make sure that the appliance is not damaged because of transport. Do not connect a damaged appliance. If it is necessary, speak to the supplier.
- Only use built-in appliances after you assemble the appliance into correct built-in units and work surfaces that obey the standards.
- Do not install the hob over a domestic appliances if the installation instructions do not allow it.
- Install the appliance only on a worktop with flat surface.
- Do not change the specifications or modify this product. There is the risk of injury and damage to the appliance.
- Fully obey the laws, ordinances, directives and standards in force in the country where you use the appliance (safety regulations, recycling regulations, electrical safety rules etc.)
- Keep the minimum distances to other appliances and units.
- Install anti-shock protection, for example install the drawers only with a protective panel directly below the appliance.
- Prevent damage of the cut surfaces of the worktop against moisture with a correct sealant.
- Seal the appliance to the worktop with no space left with a correct sealant.
- Prevent damage to the bottom of the appliance from steam and moisture, e.g. from a dishwasher or oven.
- Do not install the appliance adjacent to doors and below windows. Hot cookware can be hit off the hob when you open the doors or windows.
- Before installation, make sure that the local supply conditions (gas type and pressure) agree with the adjustment of appliance. The adjustment conditions for the appliance are on the rating plate, which you can find near the gas supply pipe.
- This appliance is not connected to a combustion products evacuation device. It must be installed and connected in accordance with current installation regula-

tions. Particular attention must be given to the relevant requirements regarding ventilation.

- **The use of a gas cooking appliance cause heat and moisture in the room in which it is installed. Make sure that the ventilation in the kitchen is good: keep natural ventilation holes open or install a mechanical ventilation device (mechanical extractor hood).**
- **More ventilation (for example opening of a window or increasing the level of mechanical ventilation where present) is necessary when you operate the appliance with intensity for a long time.**
- Carefully obey the instructions for electrical connections. There is the risk of injury from electrical current.
- **Disconnect the appliance from the electrical supply, before you do the maintenance work or you clean it.**
- The electrical mains terminal is live.
- Make electrical mains terminal free of voltage.
- Install correctly to give anti-shock protection.
- A loose and incorrect mains plug and socket connections can make the terminal become too hot.
- A qualified electrician must install the clamping connections correctly.
- Use a strain relief clamp on cable.
- Use the correct mains connection cable and replace the damaged mains cable with applicable cable. Speak to your local Service Force Centre.
- The appliance must have the electrical installation which lets you disconnect the appliance from the mains at all poles with a contact opening width of minimum 3 mm.
- If the fixing bracket is near to the terminal block, always make sure the connection cable does not come in contact with the edge of the bracket.
- You must have correct isolation devices: line protecting cut-outs, fuses (screw type fuses removed from the holder), ground leakage trips and contactors.

Disposal of the appliance

- To prevent the risk of physical injury or damage
 - Disconnect the appliance from the power supply.
 - Cut off the mains cable where it connects with the appliance and discard it.
 - Flat the external gas pipes if there are fitted.
 - Speak to your local authorised facilities for disposal of your appliance.

Installation

Warning! The following instructions about installation, connection and maintenance must be carried out by qualified personnel in compliance with standards and local regulations in force.

Important safety requirements

This hob must be installed in accordance with the Gas Safety (Installation and Use) Regulations (Current Edition) and the IEE Wiring Regulations (Current Edition). For appliances installed in the Republic of Ireland please refer to NSAI- Domestic Gas Installation I.S. 813 Current Editions and the ETCI Rules for Electrical Installations.

Provision for ventilation

Detailed recommendations are contained in the following British Standards Codes Of Practice: B.S. 6172/ B.S. 5440, Par. 2 and B.S. 6891 Current Editions.

The hob should not be installed in a bed sitting room with a volume of less than 20 m³. If it is installed in a room of volume less than 5 m³ an air vent of effective area of 100 cm² is required. If it is installed in a room of volume between 5 m³ and 10 m³ an air vent of effective area of 50 cm² is required, while if the volume exceeds 11 m³ no air vent is required.

However, if the room has a door which opens directly to the outside no air vent is required even if the volume is between 5 m³ and 11 m³.

If there are other fuel burning appliances in the same room, B.S. 5440 Part 2 Current Edition, should be consulted to determine the requisite air vent requirements.

For appliances installed in the Republic of Ireland please refer to the NSAI- Domestic Gas Installation I.S. 813 Current Editions Table Four.

Location

The hob may be located in a kitchen, a kitchen/diner or bed sitting room (with a volume greater than 20 m³), but not in a bathroom or shower room.

The minimum distance combustible material can be fitted above the hob in line with the edges of the hob is 400 mm. If it is fitted below 400 mm a space of 50 mm must be allowed from the edges of the hob.

For appliances installed in the Republic of Ireland please refer to NSAI- Domestic Gas Installation I.S 813 Current Edition Section 7- Permitted Locations of Appliance.

Gas Connection

Warning! Any gas installation must be carried out by a GAS SAFE REGISTER installer.

Make sure that, once the hob is installed, it is easily accessible for the engineer in the event of a breakdown. The manufacturer will not accept liability, should the above instructions or any of the other safety instructions incorporated in this instruction booklet be ignored. On the end of the shaft, which includes the G 1/2" threaded elbow, adjustment is fixed so that the washer is fitted between the components as shown in the diagram. Screw the parts together without using excessive force.

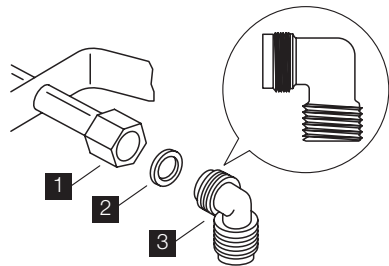

1 End of shaft with nut

2 Washer

3 Elbow

Connection to the gas supply should be with either rigid or semi-rigid pipe, i.e. steel or copper.

The connection should be suitable for connecting to R 1/2 (1/2 BSP male thread).

When the final connection has been made, it is essential that a thorough leak test is carried out on the hob and installation.

Make sure that the main connection pipe does not exert any strain on the hob.

If you use flexible metal pipes make sure that they agree to ISO 10380 and ISO 10807 standards. Be careful they do not come in touch with mobile parts or they are not squeezed. Also be careful when the hob is put together with an oven.

Important! It is important to install the elbow correctly, with the shoulder on the end of the thread, fitted to the hob connecting pipe.

Important! Failure to ensure the correct assembly will cause leakage of gas.

Important! Make sure that the gas supply pressure of the appliance obeys the recommended values.

Rigid connection:

Carry out connection by using metal rigid pipes (copper with mechanical end).

Injectors replacement

1. Remove the pan supports.
2. Remove the caps and crowns of the burner.
3. With a socket spanner 7 remove the injectors and replace them with the ones which are necessary for the type of gas you use (see table in Technical Data section).
4. Assemble the parts, follow the same procedure backwards.
5. Replace the rating label (it is near the gas supply pipe) with the one for the new type of gas supply. You can find this label in the package of the injectors supplied with the appliance.

If the supply gas pressure is changeable or different from the necessary pressure, you must fit an applicable pressure adjuster on the gas supply pipe.

Adjustment of minimum level

To adjust the minimum level of the burners:

1. Light the burner.
2. Turn the knob on the minimum position.
3. Remove the control knob.
4. With a thin screwdriver, adjust the by-pass screw position. If you change from natural gas 20 mbar to liquid gas, fully tighten the adjustment screw in. If you change from liquid gas to natural gas 20 mbar, undo the by-pass screw approximately 1/4 of a turn.



1 Minimum adjustment screw

5. Make sure the flame does not go out when you quickly turn the knob from the maximum position to the minimum position.

Electrical connection

- Any electrical work required to install this hob should be carried out by a qualified electrician or competent person, in accordance with the current regulations.
- THIS HOB MUST BE EARTHED.
- Always use a correctly installed shockproof socket.
- Make sure that there is an access to the mains plug after installation.
- Do not pull the mains cable to disconnect the appliance. Always pull the mains plug.
- The appliance must not be connected with an extension cable, an adapter or a multiple connection (risk of fire). Check that the ground connection is in conformity with the standard and regulations force.
- The power cable must be placed in such a way that it does not touch any hot part.
- Connect the appliance to the mains with a device that lets to disconnect the appliance from the mains at all poles with a contact opening width of minimum 3 mm, eg. automatic line protecting cut-out, earth leakage trips or fuse.
- None of a parts of the connection cable can not get a temperature 90°C.

Electrical Requirements

Any permanent electrical installation must comply with the latest I.E.E. Regulations and local Electricity Board regulations. For your own safety this should be undertaken by a qualified electrician, e.g. your local Electricity Board, or a contractor who is on the roll of the National Inspection Council for Electrical Installation Contracting (NICEIC).

The manufacturer declines any liability should these safety measures not be observed.

This hob is designed to be connected to a 230 V 50 Hz AC electrical supply.

Before switching on, make sure the electricity supply voltage is the same as that indicated on the hob rating plate.

The rating plate is located on the bottom of the hob.

The hob is supplied with a 3 core flexible supply cord incorporating a 3 amp plug fitted. In the event of having to change the fuse, a 3 amp ASTA approved (BS 1362) fuse must be used.

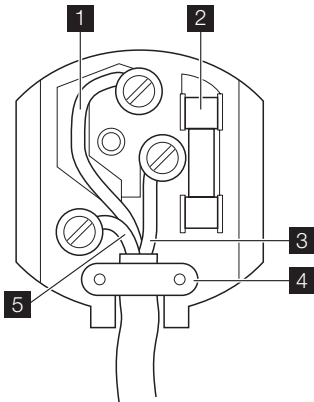

- 1** Green and Yellow
- 2** 3 amp fuse
- 3** Brown
- 4** Cord clamp
- 5** Blue

Should the plug need to be replaced for any reason, the wires in the mains lead are coloured in accordance with the following code:

- Green and Yellow - Earth
- Blue - Neutral

Building In

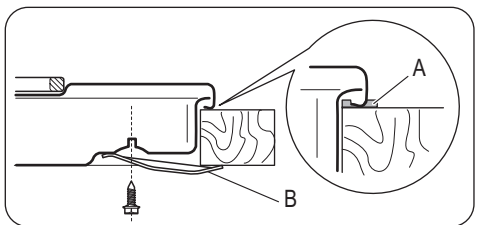
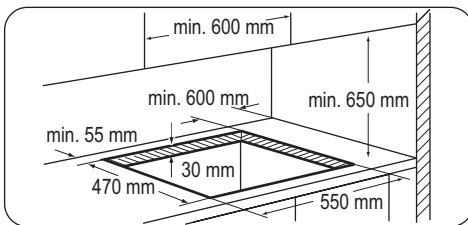

- A - supplied seal
- B - supplied brackets

Brown - Live

1. Connect the green and yellow (earth) wire to the terminal in the plug which is marked with the letter 'E' or the earth symbol (⊕) or coloured green and yellow.
2. Connect the blue (neutral) wire to the terminal in the plug which is marked with the letter 'N' or coloured black.
3. Connect the brown (live) wire to the terminal in the plug which is marked with the letter 'L' or coloured red.

Upon completion there must be no cut, or stray strands of wire present and the cord clamp must be secure over the outer sheath.

Important! A cut off plug inserted into a 13 amp socket is a serious safety (shock) hazard. Ensure that the cut off plug is disposed of safely.

Important! The replacement of electric cable must be carried out exclusively by the service force centre or by personnel with similar competencies, in accordance with the current regulations.

Replacement of the connection cable

To replace the connection cable use only H05V2V2-F T90 or equivalent type. Make sure that the cable section is applicable to the voltage and the working temperature. The yellow/green earth wire must be approximately 2 cm longer than the brown (or black) phase wire.

Possibilities for insertion

Kitchen unit with door

The panel installed below the hob must be easy to remove and let an easy access in case a technical assistance intervention is necessary.

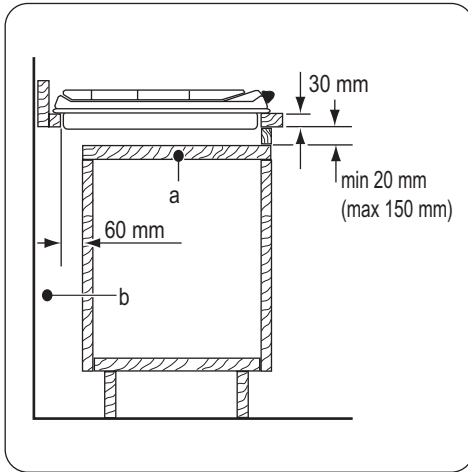

- a) Removable panel
- b) Space for connections

Kitchen unit with oven

The hob recess dimensions must obey the indication and the kitchen unit must be equipped with vents to let a continuous supply of air. The electrical connection of the hob and the oven must be installed separately for safety reasons and to let easy remove oven from the unit.

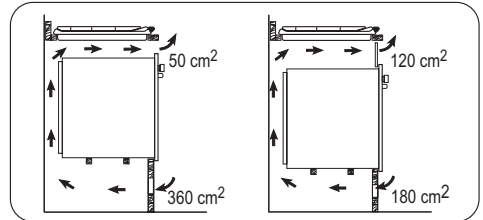

MANUFACTURER:
ELECTROLUX ITALIA S.p.A.
C.so Lino Zanussi, 30
33080 PORCIA (PN) - ITALIA

Product description

Cooking surface layout

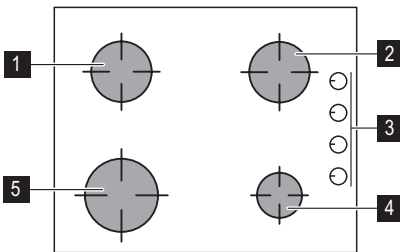

- 1 Semi-rapid burner
- 2 Semi-rapid burner
- 3 Control knobs
- 4 Auxiliary burner
- 5 Rapid burner

Control knobs

Symbol	Description
●	no gas supply / off position

Symbol	Description
☆ 🔥	ignition position / maximum gas supply
💧	minimum gas supply

Operation

Ignition of the burner

Warning! Be very careful when you use open fire in kitchen environment. Manufacturer decline any responsibility in case misuse of the flame

i Always light the burner before you put cookware.

To light the burner:

1. Turn the control knob counterclockwise to the maximum position () and push it down.
2. Keep the control knob pushed for approximately 5 seconds; this will let thermocouple to warm up. If not, the gas supply will be interrupted.
3. Adjust the flame after it is regular.

i If after some tries the burner does not light, check if the crown and its cap are in correct positions.

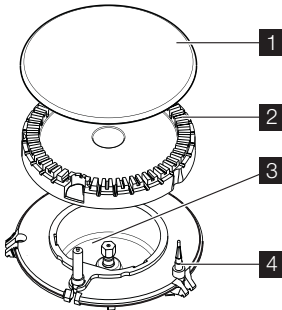

- 1 Burner cap
- 2 Burner crown
- 3 Ignition candle
- 4 Thermocouple

Warning! If the burner does not light after 15 seconds, release the control knob, turn it into off position and try to light the burner again after minimum 1 minute.

Important! In the absence of electricity you can ignite the burner without electrical device; in this case approach the burner with a flame, push the relevant knob down and turn it counter-clockwise to maximum gas release position.

i If the burner accidentally goes out, turn the control knob to the off position and try to light the burner again after minimum 1 minute.

i The spark generator can start automatically when you switch on the mains, after installation or a power cut. It is normal.

Turning the burner off

To put the flame out, turn the knob to the symbol .

Warning! Always turn the flame down or switch it off before you remove the pans of the burner.

Helpful hints and tips

Energy savings

- If possible, always put the lids on the pans.
- When the liquid starts to boil, turn down the flame to barely simmer the liquid.

Warning! Use pots and pans with bottom applicable to the dimension of burner.

Do not use cooking vessels on the hotplate that overlap its edges.

Burner	Diameters of cookware
Rapid	180 - 260 mm

Burner	Diameters of cookware
Semi-rapid	120 - 220 mm
Auxiliary	80 - 160 mm

Warning! Pots must not enter the control zone.

Warning! Make sure pot handles do not protrude over the front edge of the cooktop and that pots are centrally positioned on the rings in order to achieve maximum stability and to obtain lower gas consumption.

Do not place unstable or deformed pots on the rings to prevent from spill and injury.

 **Warning!** Flame diffuser are not recommended.

Information on acrylamides

Important! According to the newest scientific knowledge, if you brown food (specially the one which contains starch),

Care and cleaning

 **Warning!** Switch the appliance off and let it cool down before you clean it. Disconnect the appliance from the electrical supply, before carrying out any cleaning or maintenance work.

 **Warning!** For safety reasons, do not clean the appliance with steam cleaners or high-pressure cleaners.

 **Warning!** Do not use abrasive cleaners, steel wool pads or acids, they can cause damage to the appliance.

- You can remove the pan supports to easily clean the hob.
- To clean the enamelled parts, cap and crown, wash it with warm soapy water.
- Stainless steel parts wash with water, and then dry with a soft cloth.
- The pan supports **are not** dishwasher proof; they must be washed **by hand** .
- When you wash the pan supports by hand, take care when you dry them as the enamelling process occasionally leaves rough edges. If necessary, remove stubborn stains using a paste cleaner.

acrylamides can pose a health risk. Thus, we recommend that you cook at the lowest temperatures and do not brown food too much.

- Make sure you position the pan supports correctly after cleaning.
- To make burners work correctly, make sure that the arms of the pan supports are in the centre of the burner.
- **Be very careful when you replace the pan supports to prevent the hob top from damage.**

After cleaning, dry the appliance with a soft cloth.

The stainless steel can become tarnished if it is too much heated. Refer to this you must not cook with potstones, earthenware pans or cast iron plates. Do not use aluminium foil to prevent damage the top during operation.

Cleaning of the spark plug

This feature is obtained through a ceramic ignition candle with a metal electrode. Keep these components well clean to prevent difficult lighting and check that the burner crown holes are not obstructed.

Periodic maintenance

Periodically speak your local Service Force Centre to check the conditions of the gas supply pipe and the pressure adjuster, if fitted.

What to do if...

Problem	Possible cause	Remedy
There is no spark when lighting the gas	<ul style="list-style-type: none">• There is no electrical supply	<ul style="list-style-type: none">• Make sure that the unit is connected and the electrical supply is switched on.• Control the fuse. If the fuse is released more than one time, refer to a qualified electrician.
	<ul style="list-style-type: none">• Burner cap and crown are placed uneven	<ul style="list-style-type: none">• Make sure that the burner cap and crown are in correct positions.

Problem	Possible cause	Remedy
The flame is blow out immediately after ignition	<ul style="list-style-type: none"> Thermocouple is not heated sufficient 	<ul style="list-style-type: none"> After lightning the flame, keep the knob pushed for approximately 5 seconds.
The gas ring burns unevenly	<ul style="list-style-type: none"> Burner crown is blocked with food residues 	<ul style="list-style-type: none"> Make sure that the injector is not blocked and the burner crown is clear of food particles.

If there is a fault, first try to find a solution to the problem yourself. If you cannot find a solution to the problem yourself, speak your dealer or the local Service Force Centre.

i If you operated the appliance incorrectly, or the installation was not carried out by a registered engi-

neer, the visit from the customer service technician or dealer may not take place free of charge, even during the warranty period.

Labels supplied with the accessories bag

Stick the adhesive labels as indicated below:

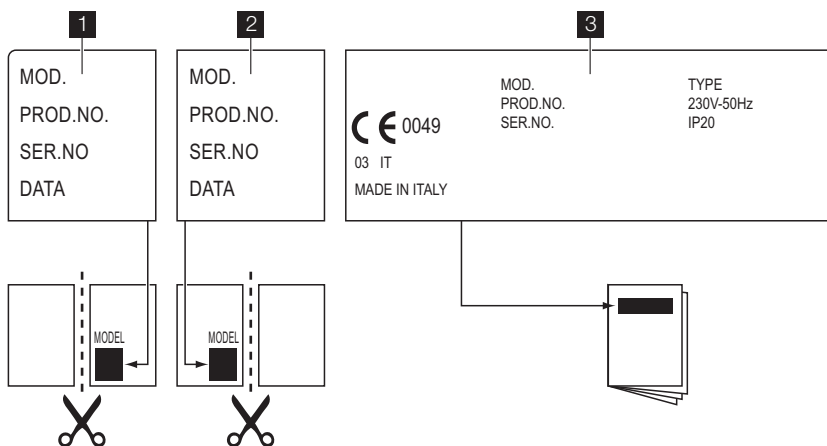

1 Stick it on Guarantee Card and send this part

2 Stick it on Guarantee Card and keep this part

3 Stick it on instruction booklet

These data are necessary to help you quickly and correctly. These data are available on the identification plate from the injectors kit.

- Model description

- Product number (PNC)

- Serial Number (S.N.)

Use the original spare parts only. They are available at Service Force Centre and approved spare parts shops.

Technical data

Hob dimensions

Width: 580 mm

Length: 500 mm

Hob recess dimensions

Width:	550 mm
Length:	470 mm

Heat input

Rapid burner:	3.0 kW
Semi-rapid burner:	2.0 kW
Auxiliary burner:	1.0 kW
TOTAL POWER:	G20 (2H) 20 mbar = 8 kW G30 (3+) 28-30 mbar = 567 g/h G31 (3+) 37 mbar = 557 g/h
Electric supply:	230 V ~ 50 Hz 3 core flexible cable with non rewirable plug fitted with a 3 amp cartridge fuse

Gas connection:	R 1/2 "
Category:	II2H3+
Gas supply:	G20 (2H) 20 mbar
Appliance class:	3

By-pass diameters

Burner	Ø By-pass in 1/100 mm.
Auxiliary	28
Semi-rapid	32
Rapid	42

Gas burners

BURNER	NORMAL POWER kW	REDUCED POWER kW	NORMAL POWER				
			NATURAL GAS G20 (2H) 20 mbar		LPG (Butane/Propane) G30/G31 (3+) 28-30/37 mbar		
			inj. 1/100 mm	m³/h	inj. 1/100 mm	g/h G30	g/h G31
Auxiliary burner	1.0	0.33	70	0.095	50	73	71
Semi-rapid burner	2.0	0.45	96	0.190	71	145	143
Rapid burner	3.0 (nat. gas) 2.8 (LPG)	0.75	119	0.286	86	204	200

Environment concerns

The symbol  on the product or on its packaging indicates that this product may not be treated as household waste. Instead it should be taken to the appropriate collection point for the recycling of electrical and electronic equipment. By ensuring this product is

disposed of correctly, you will help prevent potential negative consequences for the environment and human health, which could otherwise be caused by inappropriate waste handling of this product. For more detailed information about recycling of this product, please contact

your local council, your household waste disposal service or the shop where you purchased the product.

Packaging material



The packaging materials are friendly to the environment and can be recycled. The plastic components

are identified by marking: >PE<,>PS<, etc. Discard the packaging materials as household waste at the waste disposal facilities in your municipality.



www.zanussi.com/shop



Free Manuals Download Website

<http://myh66.com>

<http://usermanuals.us>

<http://www.somanuals.com>

<http://www.4manuals.cc>

<http://www.manual-lib.com>

<http://www.404manual.com>

<http://www.luxmanual.com>

<http://aubethermostatmanual.com>

Golf course search by state

<http://golfingnear.com>

Email search by domain

<http://emailbydomain.com>

Auto manuals search

<http://auto.somanuals.com>

TV manuals search

<http://tv.somanuals.com>