

MANUAL DE INSTRUCCIONES INSTRUCTION BOOKLET LIVRO DE INSTRUÇÕES

**ZANUSSI**

LAVAVAJILLAS  
DISHWASHER  
MÁQUINA DE  
LAVAR LOIÇA  
ZP 3414

# CONTENTS

<b>Warnings</b> .....	page 18
<b>Installation</b> .....	page 19
Positioning, levelling, adjusting the worktop, installing and securing the machine under a kitchen unit, fitting a decor panel on the door .....	page 19
Water supply connections, water outlet connection .....	page 20
Electrical connections .....	page 20
<b>Use</b> .....	page 21
Control panel .....	page 21
The water softener, filling with salt .....	page 22
Use of rinse aid, use of detergent .....	page 23
Loading the machine, use of the lower basket, use of the upper basket .....	page 24
Adjusting the height of the upper basket, reversible spray arm, .....	page 25
<b>Helpful hints</b> .....	page 25
<b>Washing programmes</b> .....	page 26
Operating sequence .....	page 27
<b>Maintenance and cleaning</b> .....	page 28
Cleaning the central filters, cleaning the large filter, internal and external cleaning .....	page 28
<b>Servicing</b> .....	page 29

## TECHNICAL SPECIFICATIONS

DIMENSIONS	Width	cm 45
	Height with worktop	cm 85
	Height without worktop	cm 82
	Max depth	cm 60
	Max depth with door open	cm 120
ELECTRICAL CONNECTION	Voltage	220 V / 50 Hz
MOTOR RATING DURING WASHING		200 W
POWER OF HEATING ELEMENT		2800 W
OVERALL POWER		3000 W
WATER SUPPLY PRESSURE	minimum	5 N/cm <sup>2</sup>
	maximum	80 N/cm <sup>2</sup>
CAPACITY (STANDARD IEC PLACE SETTINGS)		8
CONSUMPTION:	Water	18 lt
	Electricity	1.3 KW/h

**CE** This appliance complies with the following E.E.C. Directives:  
- 73/23 of 19.2.73 (Low Voltage Directive) and subsequent modifications;  
- 89/336 of 3.5.89 (Electromagnetic Compatibility Directive) and subsequent modifications.

## WARNINGS

---

**It is most important that this instruction book should be retained with the appliance for future reference. Should the appliance be sold or transferred to another owner, or should you move house and leave the appliance, always ensure that the book is left with the appliance in order that the new owner can get to know the functioning of the appliance and the relevant warnings.**

**These warnings are provided in the interest of safety. You must read them carefully before installing or using the appliance.**

- If the appliance is supplied with obvious damage, consult the supplier before installing it.
- Any plumbing and electrical work required to install this appliance should be carried out by qualified technicians.
- This appliance is designed to be operated by adults.
- Care must be taken to ensure that the appliance does not stand on the electrical supply cable or on the water inlet and drain hoses.
- Zanussi dishwashers are designed to be used for washing normal household utensils. Items that are contaminated by petrol, paint, steel or iron debris, corrosive, acidic or alkaline chemicals are not to be washed in a dishwasher.
- Under no circumstances should you open the door whilst the appliance is in operation. Always turn off the appliance before opening the door. However, the dishwasher features a special safety device which cuts off the water inlet, should the door be accidentally opened, thus avoiding water leaks.
- Never touch the heating element during or immediately after the end of the washing cycle.
- When finishing loading or unloading close the door, as an open door can be a hazard.
- It is dangerous to lean or to sit on the dishwasher door: the appliance could tip over.
- Built-in dishwashers only: the appliance must be secured to the underside of the worktop using the brackets provided. Failure to do this could result in an unstable appliance which may cause damage or injury.
- Unplug the appliance and turn off the water after use.

- Under no circumstances should you attempt to repair the appliance yourself. Repairs carried out by inexperienced persons may cause injury or more serious malfunctioning.
- This appliance should be serviced only by an authorised Zanussi Service Centre.
- Before disposing of the appliance, disconnect the water hose, cut the electrical cable and ensure that the door cannot close.

For proper disposal of the appliance, contact your local waste collection service.

# INSTALLATION

Remove all packaging before positioning the machine.

## Positioning

If possible, position the machine next to a water tap and a drain.

The sides and the back of the dishwasher can rest against the adjacent furniture or the wall.

The dishwasher features fill and drain hoses which can be turned either to the left or the right to suit the installation.

## Levelling

Good levelling is essential for correct closure and sealing of the door.

Loosen or tighten the adjustable support feet, until the machine is perfectly level.

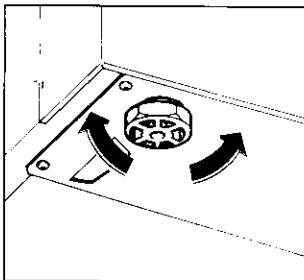

## Adjusting the Worktop

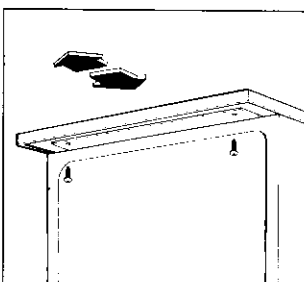

You can move the worktop forward or backward by 25 mm in order to align the machine with other kitchen units.

Simply unscrew the two front retaining screws, move the top to the required position and then retighten the screws.

## Installing and Securing the Machine Under a Kitchen Unit (Sink-Worktop Unit)

By removing the machine's worktop, you can install it under a close fitting sink unit or a pre-existing top, if the dimensions of the recess correspond to those shown in the picture.

### Then proceed as follows:

Remove the machine worktop by unscrewing the two front retaining screws and slide out of the rear slots, lifting the worktop.

Insert the machine after adjusting the height and levelling with the adjustable feet. When inserting the machine, ensure that the water inlet and drain hoses are not kinked or squashed.

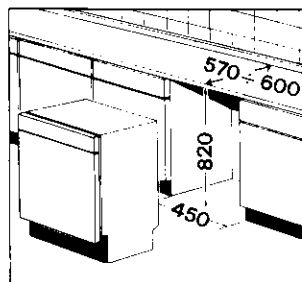

## Caution

Once the machine has been installed, ensure that it can be accessed easily for servicing.

## Fitting a Decor Panel on the Door

The door of this machine has frames for fitting a plastic laminate decor panel in the colour required to match the dishwasher panel with the rest of the kitchen furniture. If you wish to do this you must provide the panel yourself.

Width:	436 mm
Height	592 mm
Max thickness:	4 mm

## To Fit the Panel

Take the door frame off after removing the retaining screws around the edge.

Position the panel, refit the frame and tighten the retaining screws around the edge.

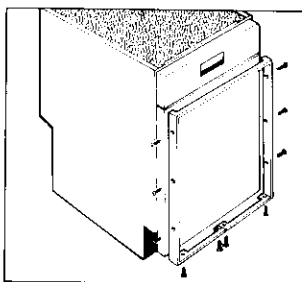

## Note

The panel should be fitted before positioning the machine.

## Water Outlet Connection

The end of the drain hose can be connected as follows:

to the sink outlet siphon, securing it if necessary with a clip;

to a wall outlet provided with vent-hole, minimum internal diameter 4 cm;

hooked over the edge of the sink using the special curved plastic guide provided.

The waste connection must be at a height of between 30 cm (minimum) and 100 cm (maximum) from the floor.

It makes no difference which way the drain hose faces, either to the right or left of the dishwasher.

Avoid bending or kinking the hose as this could prevent or slow down the discharge of water.

If you use a drain hose extension it must be no longer than 2 metres and its internal diameter must be no smaller than the diameter of the hose provided.

Likewise the internal diameter of the couplings used for connection to the waste outlet must be no smaller than the diameter of the drain hose.

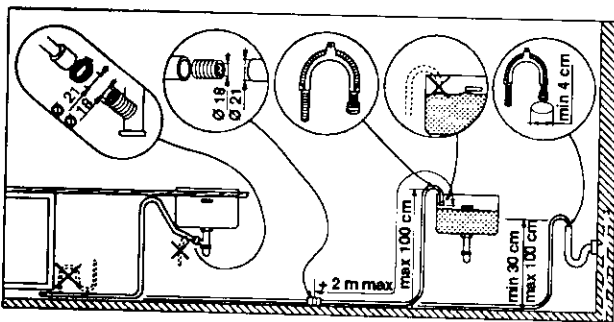

## Water Supply Connections

This dishwasher may be fed with either hot (max. 60°C) or cold water.

Nevertheless we advise you a cold water supply. A hot water supply is not always efficient with very soiled crockery as it shortens the washing programmes a lot.

Feeding the appliance with a hot water supply (max. 60°C) will allow you to obtain considerably shorter programmes.

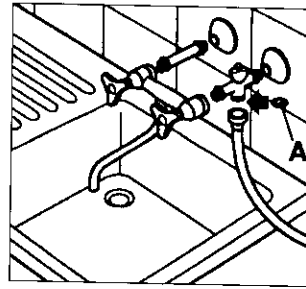

For making the connection itself, the coupling nut fitted to the machine's supply hose is designed to screw onto either a 3/4 inch gas thread spout, or to a purpose made quick-coupling tap such as the Press-Block. To make

this easier, the hose itself may be turned to the left or the right. In either case, be sure to incorporate the strainer (A) supplied with the machine onto the joint. See picture.

The water pressure must be within the limits given in the technical specifications, as it will not function correctly if pressure is outside these specifications.

**Caution:** the retaining ring must be properly fitted so as to avoid water leaks.

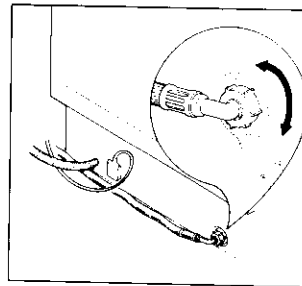

**Note:** the end of the hose connected to the machine can be positioned as required, by simply slacking the retaining ring.

Re-tighten the ring securely to avoid water leaks.

Avoid bends or kinks in the hose, which could prevent or slow down the flow of water.

If the machine is connected to new pipes or pipes which have not been used for a long time, you are advised to run the water for a few minutes before connecting the inlet hose. This will prevent deposits of sand or rust clogging the inlet hose filter.

## Electrical connection

Before plugging the appliance into the wall socket, make sure that:

1. the mains voltage corresponds to the voltage given in the technical specifications;

2. the meter, fuses, mains power supply and wall socket can all take the maximum load required.

Make sure that the socket and plug are compatible without having to use any type of adapter. If necessary, have the domestic wiring system socket replaced.

**Safety standards require the appliance to be earthed.**

**The Manufacturer accepts no liability for failure to observe the above safety precautions.**

## Control panel

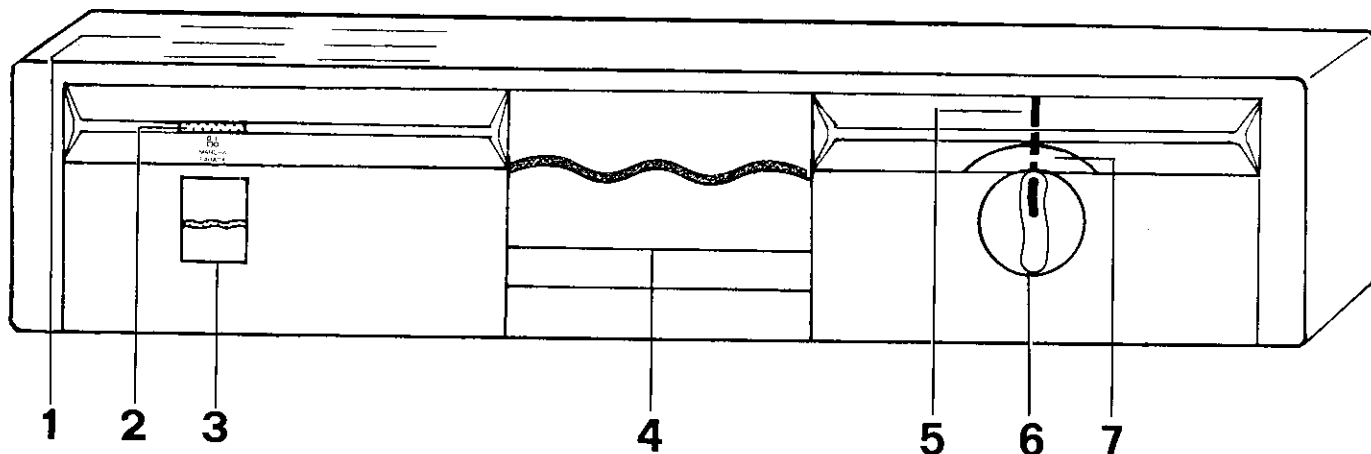

### 1. Programme Guide

This is a summary of the washing programme chart to help you to select the correct programme.

### 2. Pilot Light

This comes on when the ON/OFF button (3) is depressed, indicating that the machine is on.

### 3. ON/OFF Pushbutton ( )

#### ON

By depressing this pushbutton the machine starts operating and, at the same time, the pilot light (2) comes on.

#### OFF

When the washing programme has finished, the machine stops automatically and the pilot light (2) remains on.

To switch the pilot light off or to stop the machine at any time, press the same button  again.

### 4. Door Handle

To open the door press the catch in the top of the recess and pull the door toward you at the same time.

### 5. Programme Marker





### 6. Programme Selector Dial

To select a programme, push the Programme Selector Dial in to make it pop out. Then turn it clockwise, making sure that the programme letter you wish to select corresponds with the Marker (5) on the window.

### 7. Wash programme phase indicator

During the washing programme the Programme Selector Dial turns indicating the phase being performed.

The symbols have the following meaning:

-  Prewash
-  Main wash
-  Cold rinse
-  Warm rinse
-  Hot air drying

## The Water Softener

Water contains varying amounts of lime and mineral salts depending on the area in which you live: these are deposited on the dishes leaving white marks.

The higher the content of these salts, the harder your water will be. The «hardness» level is measured on 2 equivalent scales: French Degrees or German Degrees.

Contact your local Water Authority to find the exact water hardness level for your area.

The dishwasher is equipped with a softener which uses special dishwasher salt to provide lime-free (softened) water. The softener can treat water hardness up to 90 french degrees via 5 adjustment levels.

Find on the table below the level corresponding to the hardness of your water and the required adjustments:

Water hardness		Level	Use of salt	Water softener adjustment	Adjustment on the machine
°dH German degrees	°TH French degrees				
0- 7	0-14	1	NO	NO	NO
8-21	15-39	*2	YES	NO	NO
22-28	40-50	3	YES	YES	NO
29-39	51-70	4	YES	NO	YES
40-50	71-90	5	YES	YES	YES

\* The water softener is factory set at level 2 as this suits most users.

### Level 1

If your water is «level 1» it is already soft and therefore there is no need to use salt.

### Levels 3 and 5 (water softener adjustment)

If your water is level 3 or 5, proceed as follows:

slide out the lower basket and unscrew the cap of the salt container;

turn the two-position selector anticlockwise from position  $-$  to position  $+$  with the aid of a knife or a screwdriver.

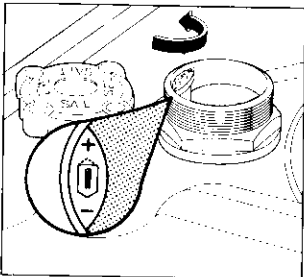

### Levels 4 and 5 (adjustment on the machine)

If your water is level 4 or 5, open the door and drill membrane (A) on the upper left-hand corner of the machine.

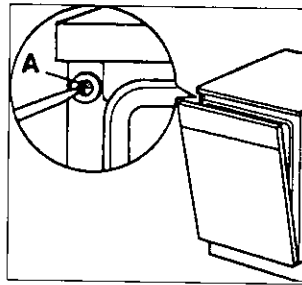

With a water hardness of level 5 both adjustments must be made.

### Important

**Salt MUST be used regularly from level 2 upward.**

### Filling with Salt

Only use salt designed specifically for use in dishwashers. Other types of salt contain high percentages of other substances which may reduce the efficiency of the softener.

Unscrew the cap of the salt container.

Fill the container with water.

Place approximately 1 kg of dishwasher salt inside using the funnel provided (see figure).

Replace the cap making sure that there is no trace of salt on the screw thread or on the gasket.

Screw the cap on tightly.

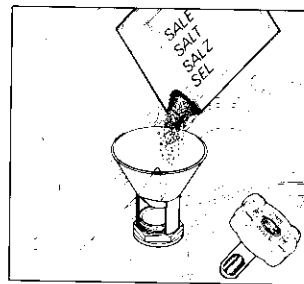

When this has been done, all that is required is to periodically add salt to the container. You are reminded of this by a green refill indicator on the cap of the salt container. When the green indicator disappears, the water softener needs refilling with salt.

### Caution

Only fill with salt just before starting one of the complete washing programmes (not the Rinse and Hold programme). This will prevent any grains of salt or salty water, which may have been spilled, remaining on the bottom of the machine for any period of time. This could cause corrosion.

## Rinse Aid

This liquid gives the dishes a shiny finish and improves drying. It is automatically added during the hot rinse. The dispenser, which is positioned inside the door, holds about 110 ml of rinse aid, which is sufficient for 16-40 dishwashing programmes, depending upon the dosage setting.

### Filling with Rinse Aid

Open the container by turning the lid (A) anticlockwise. Add rinse aid until the container is completely full (approx. 110 ml). The indicator (B) will be completely dark.

Top up with rinse aid when the indicator (B) becomes clear.

**Remember to CLOSE the lid after every refill.**

### Caution

Clean up any rinse aid spilt during filling with an absorbent cloth to avoid excess foaming during the next wash.

### Adjusting the Dose

According to the finish and drying results obtained, adjust the dose of rinse aid by means of the 6 position selector (C) (position 1 - minimum dose, position 6 - maximum dose). Gradually increase the dose if there are drops of water or lime spots on the dishes after washing. Reduce it if there are sticky whitish streaks on the dishes.

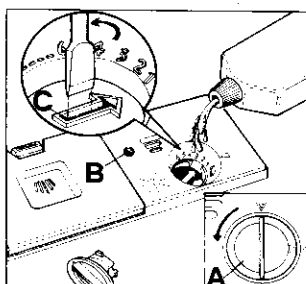

## Use of Detergent

Before starting any of the dishwashing programmes, except for the rinse and hold programme, load the detergent in the dispenser.

Use only tablets, powder or liquid detergents specifically designed for domestic dishwashers.

Unsuitable detergents (such as those for washing by hand) do not contain the right ingredients for machine washing and hamper correct functioning of the machine.

To open the dispenser lid, pull the catch (D). This will open it.

At the end of any washing programme the lid is always open, ready for the next wash.

The amount of detergent to be used varies depending on how soiled the dishes are and the type of dishes being washed. We recommend the amounts shown in the programme chart.

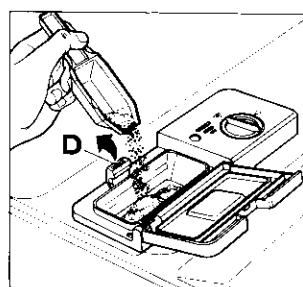

**After filling the dispenser with detergent, close the lid.**

Since not all detergents are the same, you should also consult the instructions on the packet.

Remember that insufficient quantities of detergent will produce poor washing results whereas an excessive amount of detergent does not improve washing results and is also wasteful.

Using no more than the correct amount of detergent also contributes to reducing pollution.

Zanussi recommends the use of Finish dishwasher detergent.



## Loading your Machine

Before placing dishes in the machine, remove any large scraps of food from the plates (small bones, toothpicks, fish bones, scraps of meat and vegetables, fruit skins etc.) to avoid clogging the filters and consequently reducing performance.

Open the door and slide out the baskets to load the dishes.

## Use of the Lower Basket

The lower basket is designed to take saucepans, lids, plates (up to 27 cm in diameter), salad bowls, cutlery etc.

Serving dishes and large lids should be arranged around the edge of the basket, ensuring that the upper spray arm can turn freely.

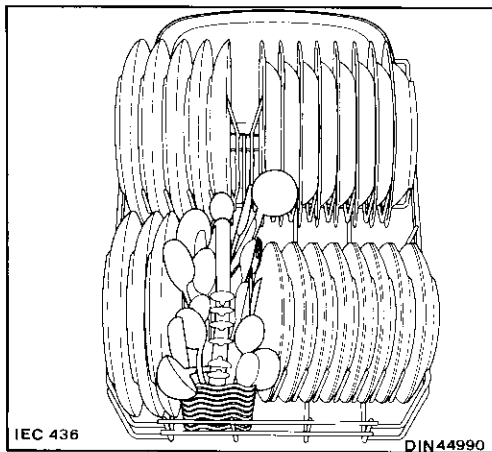
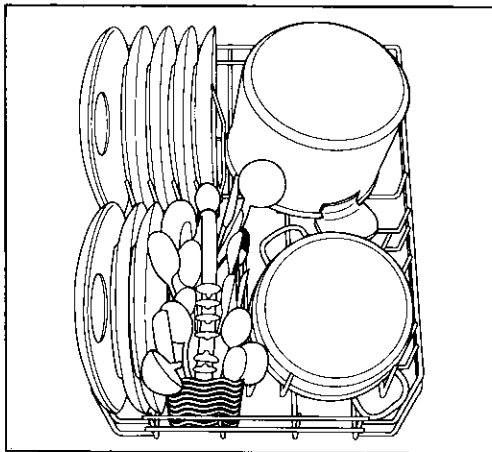

Cutlery should be placed in the removable cutlery basket with the handles facing downwards. If the handles protrude from the bottom of the basket, obstructing the lower spray arm, load the cutlery with the handles facing upward.

Mix spoons with the other cutlery to prevent them sticking together.

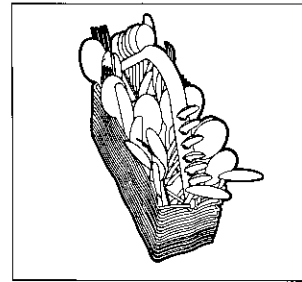

Teaspoons may be loaded into the special slots provided in the cutlery basket handle.

## Use of the Upper Basket

The upper basket is designed for plates (dessert plates, saucers, dinner plates up to 24 cm in diameter), salad bowls, cups and glasses; these should be arranged as shown in the pictures.

Glasses with long stems can be placed upside-down in the raised cup-racks.

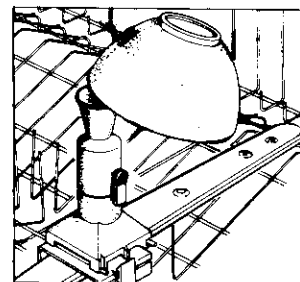
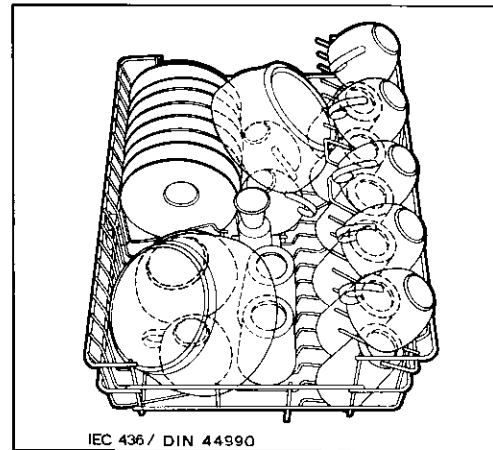
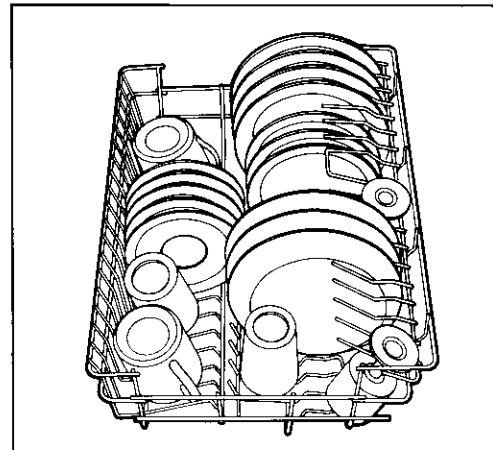

### Caution

When loading the dishes, ensure that you do not cover the water inlet funnel in the middle of the upper basket.

**Before closing the door, ensure that the spray arms can rotate freely.**

## Adjusting the Height of the Upper Basket

If washing very large plates (over 27 cm and up to 31 cm in diameter) you can load them in the lower basket after moving the upper basket to the higher position as follows:

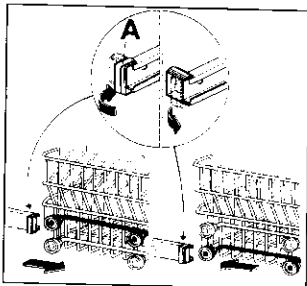

Move the front runner stops (A) of the upper basket outward and slide the basket out.

Refit the basket in the higher position and replace the stops (A) in their original position.

When the top basket is in the higher position it will only take plates up to 20 cm in diameter and you will not be able to use the raised cup racks.

---

## HELPFUL HINTS

---

### For Best Washing Results:

Before loading, remove all scraps of food and soak very heavily soiled pots and pans.

Always arrange saucepans, cups and glasses etc. upside-down.

Tilt items with convex or concave surfaces so that the water drains off easily.

Long items of cutlery such as ladles, carving knives etc. should be positioned horizontally in the upper basket.

Avoid contact between the dishes as far as possible; correct arrangement of the items will give better washing results.

Light items (plastic bowls etc.) should be loaded in the upper basket and arranged so that they do not move during washing.

You will improve drying results by leaving the dishwasher door ajar for at least 15-30 minutes as soon as the programme finishes.

### To Save Energy

Do not prewash dishes under running water.

Place dishes in the machine immediately after every meal and wait until the dishwasher is full before washing.

If necessary run the Rinse and Hold programme (see Programme Chart on the following pages), so that any food scraps do not become caked on the dishes while you are waiting to run the complete wash programme.

### Items not Suitable for Dishwashers

**The following should not be washed in the dishwasher:**

Cutlery or dishes with wooden or horn handles or glued parts.

Handmade items, wooden objects, antiques or hand-painted china.

Certain types of decoration can discolour when washed in a dishwasher.

Crystal-ware and plastic objects, if not guaranteed dishwasher-proof, should be washed by hand. You are advised to place them in the upper basket and to select a delicate programme.

Certain types of glass can also become opaque after being washed several times in a dishwasher.

Silver cutlery tends to go black if mixed with steel cutlery. Place it in the cutlery basket separate from the others.





Iron and cast iron objects can rust and stain other items.

Aluminium tends to go black; copper, pewter and brass tend to stain.

**Caution: You are advised not to load very small items which can fall through the baskets.**

**Note:** When buying new dishes, ensure that they are dishwasher-proof.

## Washing programmes

Programmes	Type of load	Quantity of food scraps Type of soil	Starting position of the programmer	Required push-buttons	Recommended quantity of detergent	Cycle description
* <b>NORMAL WITH PREWASH</b> (Normal con prelavado)	Pots - Pans Crockery	Normally or heavily soiled, also dried up and/or containing starch (i.e. pasta, rice, semolina, potatoes, egg, sauces, roast).	<b>A</b>		2 level dessert spoons (20 g)	Cold prewash Main wash up to 65°C 1 cold rinse 1 hot rinse up to 65°C Hot air drying
<b>NORMAL NO PREWASH</b> (Normal sin prelavado)		Lightly soiled, also dried up and/or containing starch (i.e. pasta, rice, semolina, potatoes, egg, sauces, roast).	<b>B</b>		2 level dessert spoons (20 g)	Main wash up to 65°C 1 cold rinse 1 hot rinse up to 65°C Hot air drying
<b>** QUICK WASH</b> (Breve)	Crockery Party crockery	Lightly soiled, not dried up and starchless (i.e. drinks, cakes and pastry, salad, sliced ham, cheese). Due to the shortness of this programme, no drying phase is provided.	<b>C</b>		1 heaped dessert spoon (15 g)	Main wash up to 65°C 1 cold rinse 1 hot rinse up to 65°C
<b>RINSE &amp; HOLD</b> (Remojo)		Partial load to be completed later. This programme does not require any detergent.	<b>D</b>		/	1 cold rinse (to avoid food scraps from sticking to the crockery)

\* This programme is equivalent to IEC436 standard.  
Recommended quantity of detergent: 20 g  
Standard place settings: 8.

\*\* This is a special programme for quick washing (approx. 38 minutes) a full load of lightly soiled dishes, glasses and crockery (except pots) so that you may re-use them promptly. Due to the shortness of this programme, no drying phase is provided.

## Operating Sequence

### 1 Check that the filters are clean (see cleaning instructions)

### 2 Check that there is salt and rinse aid

### 3 Load the dishes

Remove larger scraps of food.

Pull the lower basket out and arrange the saucepans, plates and cutlery in it.

Pull the upper basket out and arrange the plates, saucers, glasses and cups etc. in it.

Slide the baskets back into the machine.

Ensure that the spray arms can rotate freely.

### 4 Measure out detergent

Pour the required amount of detergent into the dispenser according to the indications in the Washing Programmes chart and close the lid.

Close the dishwasher door.

### 5 Set the programme

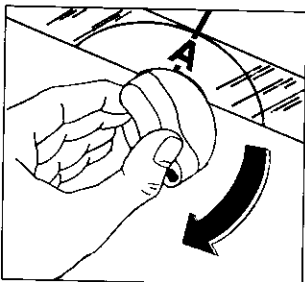



Turn the Programme Selector Dial clockwise until the letter of the programme you wish to select corresponds with the fixed Marker on the window over the dial.

### 6 Start the programme

Insert the plug into the wall socket.

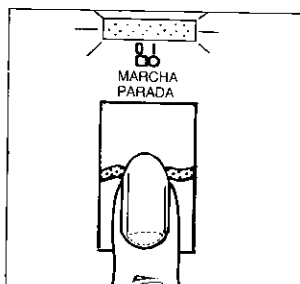
Open the water tap.



Depress the ON/OFF pushbutton . The pilot light will come on and the machine will start.

If you wish to interrupt the wash at any time press button  again.

To restart the machine, depress the same button again and the programme will continue from the point where it was interrupted.

### 7 At the end of the washing programme the White Marker will correspond with the Green Marker on the window.

The machine will stop and the pilot light remains on until ON/OFF button  is depressed.

Turn off the water tap.

Open the door and wait a few minutes before removing the dishes; in this way you will avoid burning your fingers and drying will be improved.

Empty the lower basket first and then the upper one; this will avoid water dripping from the upper basket onto the dishes in the lower one.

#### Caution

In general it is not advisable to open the door while the machine is working; if the door is opened however, a safety device ensures that the machine stops.

If you have to open the door while the machine is working, always switch off the appliance first by pressing the ON/OFF button .

# MAINTENANCE AND CLEANING

## Cleaning the Central Filters

(After each wash)

Inspect the central filters (B) and (C) and remove any scraps of food with a brush, under running water.

Filters (B) and (C) are both removed by lifting up the outer one (B) (pulling the central funnel upwards); the smaller filter (C) can then be removed by pressing the two tongues (D).

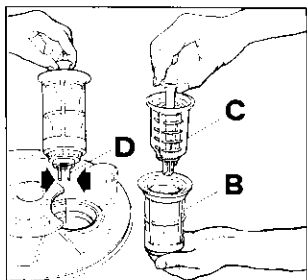

Once cleaned, refit the filters by pressing them down until they click into place.

## Cleaning the Large Filter

(Once a month)

Clean the large filter (A) on both sides under running water, using a brush.

To take it out, remove the spray arm by pressing the two tongues (E), turn the ring (F) anticlockwise (towards the left) and then slide the whole part out.

Refit the filter following the above instructions in reverse order.

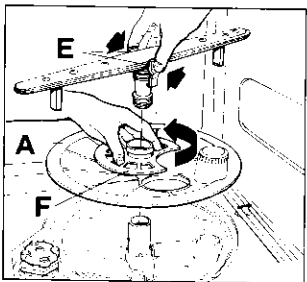

**Caution:** the dishwasher must not be used without filters.

**Incorrect repositioning of the filters will produce poor washing results.**

**Cleaning of the filters is vital to ensure correct operation of the machine.**

## Internal and External Cleaning

You must ensure that the seals around the door, the detergent and rinse aid dispensers are cleaned regularly with a damp cloth.

Check that the spray arm nozzles are not obstructed. To remove the bottom spray arm, release it from its securing catches and pull it out. To clean the nozzles of the top spray arm, slide out the top basket whereby the spray arm will become accessible. To remove it, unhook it from the central support (see Reversible Spray Arm).

Clean the external surfaces of the machine and control panel with a soft damp cloth. If necessary use only neutral detergents. Never use abrasive products, scouring pads or solvents (acetone, trichloroethylene etc...).

## Prolonged Periods of Non-Operation

If you are not using the machine for any period of time you are advised to:

unplug the appliance and turn off the water;

fill the rinse aid dispenser;

leave the door ajar to prevent the formation of unpleasant smells;

leave the inside of the machine clean.

## Frost Precautions

Avoid placing the machine in a location where the temperature is below 0°C.

If this is unavoidable, empty the machine, close the water inlet tap, disconnect the water inlet pipe and empty it.

## Moving the Machine

If you have to move the machine (you are moving house etc...):

unplug it;

turn off the water tap;

remove the water inlet and discharge hoses;

pull the machine out together with the hoses.

**Caution:** avoid over tilting the machine during transport.

# SERVICING

Certain problems are due to lack of simple maintenance or oversights and can be solved easily without having to call out an engineer.

## The machine will not start

- The door has not been properly closed.
- The plug is not properly inserted in the power socket.
- There is no current at the socket. Check the fuse.

## The machine will not fill with water

- The water tap is shut.
- The water supply has been cut off.
- The inlet hose is kinked.
- The water inlet hose filter is clogged.

## The machine will not drain

- The drain hose is kinked.
- The sink drain is blocked.
- The drain hose extension is not correct.
- There is no air vent in the end of the drain hose.

## The dishes are not clean (poor wash)

- The baskets are too full.
- The dishes have not been arranged properly.
- The spray arms do not rotate.
- The spray arm holes are clogged.
- The water inlet funnel in the centre of the upper basket is covered by dishes.
- The end of the drain hose is submerged in waste water (in the sink).
- The filters are clogged.
- The filters are not in position.
- Not enough detergent has been used or it is unsuitable.
- The detergent is old or has gone hard.
- The salt container cap is not properly closed.
- The washing programme selected is too gentle.

## Visible lime deposits or white film on the dishes

- There is no salt or the softener has not been adjusted to the hardness of the water.
- The rinse aid has run out or too little is being used

## The machine is noisy

- The dishes are rattling against each other.
- The spray arms are knocking against the dishes.

## The dishes are not quite dry

- The dishes have been left too long inside the machine.

## The door is difficult to close

- The dishwasher is not level or is not properly built-in.

If, after the above checks, the fault persists, call your nearest Service Centre, indicating the fault, the appliance model (Mod.), the product number (Prod. No.) and the serial number (Ser. No.). This information can be found on the rating plate located on the right-hand side of the dishwasher door (see picture).

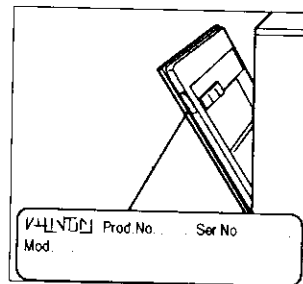

## Free Manuals Download Website

<http://myh66.com>

<http://usermanuals.us>

<http://www.somanuals.com>

<http://www.4manuals.cc>

<http://www.manual-lib.com>

<http://www.404manual.com>

<http://www.luxmanual.com>

<http://aubethermostatmanual.com>

Golf course search by state

<http://golfingnear.com>

Email search by domain

<http://emailbydomain.com>

Auto manuals search

<http://auto.somanuals.com>

TV manuals search

<http://tv.somanuals.com>