

# ZANUSSI

 Electrolux

## DISHWASHER ZSF 2400

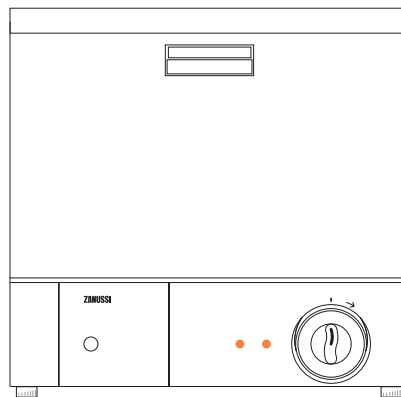

# Contents

## For the user

<b>Important safety information</b>	<b>3</b>
<b>Description of the appliance</b>	<b>4-5</b>
- General cleaning	
- Rinse aid dispenser	
- Spray arm	
- Coarse filter	
- Fine filter	
- Detergent dispenser	
- Water softener	
- Water softener plug	
- Cleaning the cabinet	
<b>The control panel</b>	<b>6</b>
<b>How to load the dishwasher</b>	<b>7</b>
-Instruction for test centres	
<b>Using your appliance</b>	<b>8</b>
<b>Something Not Working?</b>	<b>9</b>
<b>Service</b>	<b>10</b>
- Service and Spare Parts	
- Customer Care Department	
<b>Guarantee Conditions</b>	<b>11</b>

## For the installer

<b>Technical specifications</b>	<b>12</b>
<b>Unpacking the machine</b>	<b>13</b>
- If the machine is damaged	
- Use	
- Protecting the machine against freezing	
<b>Installation</b>	<b>14-15</b>
- Water inlet	
- Water drainage	
- Power supply	

## Guide to use the instruction book

The following symbols will be found in the text to guide you throughout the instructions:



**Safety information**



**Step by step instructions**



**Hints and tips**



**Environmental information**



# Important safety information

**Before installing and first using the dishwasher, read the instruction booklet carefully, including its hints and warnings. Doing so will ensure that your machine will perform properly and to best advantage. Anyone using the machine should be thoroughly familiar with its instructions for use and safety features. Save these instructions and make sure they remain with the machine if it is moved or sold, so that everyone using it through its life can be properly informed on appliance use and safety.**

## Installation and servicing

- All installation and service work done on the product must be carried out by a qualified technician. Work performed by persons with inadequate knowledge may adversely affect the satisfactory functioning of the product and may cause personal injury or damage. Before any work is carried out on the dishwasher, it must be isolated from the electrical supply. To do this the power plug must be removed from the wall socket.
- Water connection should be made via an easily accessible tap.
- The power cable must be plugged into an earthed socket, which must be easily accessible. Permanent installation must only be carried out by an authorised electrician or competent person.
- If the power cable is damaged, it must be replaced by a Service Force engineer. Please contact your local service centre on 08705 929 929.
- Make sure that the power cable is not nipped or otherwise damaged and that the hoses do not get crushed or kinked when moving the dishwasher when installing or cleaning etc.
- Servicing and possible repairs must be carried out by a Service Force engineer. Always insist on genuine spare parts. Never try to repair the dishwasher yourself.

## Child Safety

- The dishwasher should be used by adults only. Do not let children play with the controls or other parts of it.
- Do not allow children to play with the packaging. Risk of suffocation.
- Keep all detergents in safe place out of children's reach.
- Prevent children from sitting, swinging or standing on the open door.

## During Use

- This dishwasher is designed solely for washing household utensils suitable for machine washing. Using it for other purposes could lead to physical injury or damage to property and invalidate the guarantee.
- Avoid opening the door while the dishwasher is running, as hot steam may escape.

- Only use detergent specifically designed for use in dishwashers.
- If you take any dishes out of the machine before the end of the dishwashing cycle, it is extremely important to rinse them thoroughly under running water to remove any remaining detergent.
- Do not place sharp knives with their points upwards. It is much safer to lay them horizontally in the basket.
- Ensure that the door of the dishwasher is always closed when it is not being loaded or unloaded. In this way you will avoid anybody injuring themselves on the open door.
- Make sure that the machine is disconnected from the power supply during cleaning and maintenance work.
- After using the machine, turn off its water supply and disconnect it from the power supply. When removing the electrical plug, grip the plug, not the cable. **Never touch the switch or plug with wet hands!**

## Conservation



### - packaging:

All materials used in packaging this appliance are environmentally-friendly. The various plastics used are identified and can be recycled:

- PE stands for polyethylene, which is used for the bag around the appliance and the bag in which these instructions were supplied.
- PS stands for polystyrene (moulded), which is used for the sections of packaging needed to cushion the appliance.

The cardboard components of the packaging are made from recyclable paper and should be taken to a collection point for recycling.

### - old apparatus:

The symbol  on the product or on its packaging indicates that this product may not be treated as household waste. Instead it shall be handed over to the applicable collection point for the recycling of electrical and electronic equipment. By ensuring this product is disposed of correctly, you will help prevent potential negative consequences for the environment and human health, which could otherwise be caused by inappropriate waste handling of this product. For more detailed information about recycling of this product, please contact your local city office, your household waste disposal service or the shop where you purchased the product.

# Description of the appliance

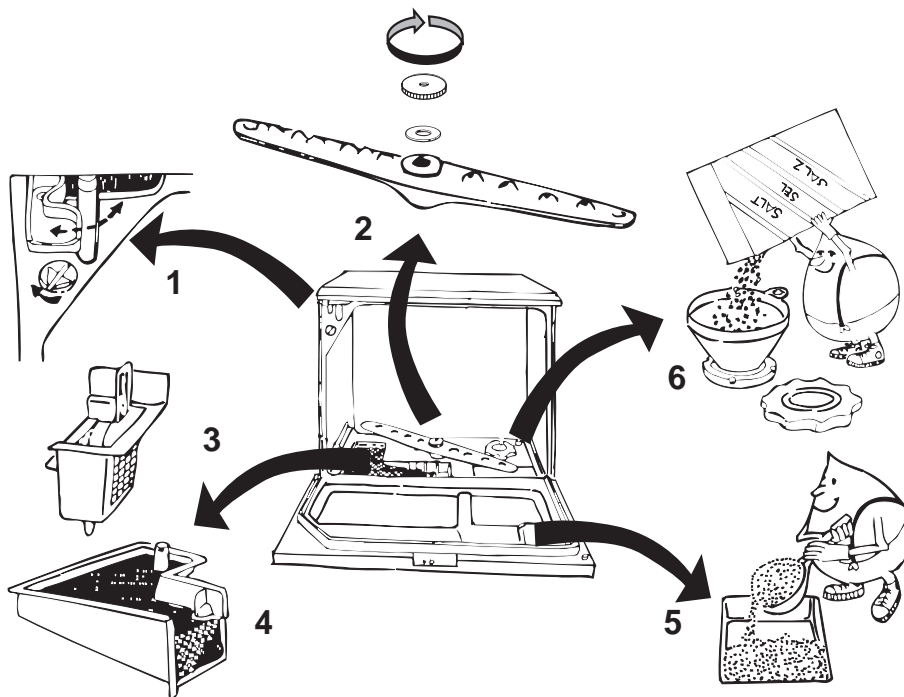

## Rinse aid dispenser (1)

Use of rinse aid will result in faster drying of the load and gives the dishes a shiny finish. It may be necessary to adjust the quantity of rinse aid dispensed if you live in either a very hard water or a very soft water area. More is needed for hard water and less for soft water. Leave the dispenser in its preset position when you first use the dishwasher and only adjust if, after a few cycles, you notice the following:

- Crockery remaining dull looking and/or showing occasional round spots. If this happens, increase the quantity of rinse aid by turning the red dial below the filler trough clockwise.
- Crockery feeling sticky or showing whitish spots. If this happens, decrease the quantity of rinse aid by turning the red dial below the filler trough anti-clockwise.

The dispenser holds about 140 ml. This is enough for 40-70 wash cycles, depending on the dosage setting. When the rinse aid level is approaching the bottom of the scale it is time to refill the dispenser. Swivel out the filler trough and carefully fill up with rinse aid until the level reaches up to the red mark on the level indicator tube. Do not overfill, and carefully wipe off any spillage with a damp cloth immediately. Don't forget to close the filler trough afterwards.



**Do not fill the rinse aid dispenser with liquid detergent.**

## Spray arm (2)

The holes in the spray arm nozzle must be kept clean to ensure satisfactory wash results. Inspect the spray arm regularly. When thorough cleaning is necessary, remove the spray arm by unscrewing the nut clockwise (it has a left-handed thread) and lift off the spray arm.

Wash the spray arm with hot soapy water using a stiff saucepan brush if necessary to remove scraps.

Re-assemble carefully, making sure the nut is secure.

## Coarse filter (3)

The purpose of the coarse strainer is to catch large objects such as a cocktail stick and pieces of eggshell. Make sure that the filter is always clean. Lift it out and rinse it under running water whenever necessary.

## Fine filter (4)

It is just as important to keep this filter clean. A dirty or clogged filter will impair washing efficiency. The fine filter can easily be lifted out for cleaning when you have removed the coarse filter.



**The dishwasher must not be used without the filters. Incorrect repositioning of the filters will produce poor washing results.**



Cleaning of the filters is vital to ensure correct operation of the machine.

## Detergent dispenser (5)

Only use detergents specially designed for dishwashers. Pour the detergent into the compartment, for a normal load pour about 15g. Since not all detergents are the same, you should also consult the instructions on the packet. Remember that the instructions usually refer to full-size dishwashers, for example when using detergent tablets, it is sufficient to use just half a tablet. Using the correct amount of detergent also contributes to reducing pollution.



Zanussi recommends the use of Finish dishwasher detergent and Rinse Aid.

## Water softener (6)

This dishwasher is equipped with a water softener for hard (chalky) water, therefore the rinse aid dispenser should be set for a low dosage.

The lime (chalk) in hard water causes white deposits to occur on dishes and the interior of the dishwasher.

To prevent this, the water has to pass through a special container where its hardness is removed. Since the water softener consumes coarse dishwasher salt, you will have to replenish the salt container after a certain number of dishwashing cycles. When the indicator lamp on the control panel lights up, it is time to fill up with salt.

### Proceed as follows:

1. Unscrew the salt container filler cap.
2. Fill up salt container with water (only the first time).
3. Fill the container with coarse salt. Use the funnel supplied with the machine.  
Ordinary domestic salt will affect the efficiency of the water softener and damage it.
4. Remove the funnel and wipe off any spillage.
5. Screw the filler cap back in place.

The salt container holds about 1 litre, which is enough for about 20 - 30 dishwashing cycles. Always ensure that there is water in the salt container before filling with salt.

## Water softener plug (7)

As supplied from the factory, the water softener is set for a water hardness of up to 20°dH. If your water is harder than this, you can increase the capacity of the water softener by pulling out the rubber plug at the rear of the dishwasher on the left hand side viewed from the back. See illustration.

Contact your local Water Authority to find the exact water hardness level for your area.

Never run the dishwasher without salt in the container as this may damage the water softener. If the damage is slight, the water softener function can be partially restored by filling the container with salt and then running the Normal cycle 4-5 times.

## Important

Make sure that the machine is unplugged and the water turned off before undertaking any kind of maintenance.

## General cleaning

Inspect the filters and spray arm nozzle before re-loading the machine and remove any food scraps. Wipe round the rubber gasket at the bottom of the door to remove grease which tends to collect there.

## Cleaning the cabinet

Wipe the outside of the cabinet and control panel regularly with a soft damp cloth. When necessary, use liquid kitchen or household cleaner to remove stubborn marks, rinse with a damp cloth and rub up with a soft duster.

Never use abrasive cleaners which could damage the surface, ie: scouring pads or solvents (acetone, trichloroethylene, etc).

If the machine is not going to be used for some time, take the following precautions:

1. Unplug the machine and turn off the water supply.
2. Fill up the rinse aid container.
3. Make sure the tub is clean by carrying out a wash programme (without any crockery) using Finish Dishwasher cleaner, then dry the inside thoroughly.
4. Leave the door ajar.

7

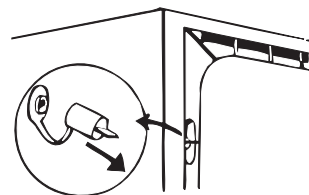

# The control panel

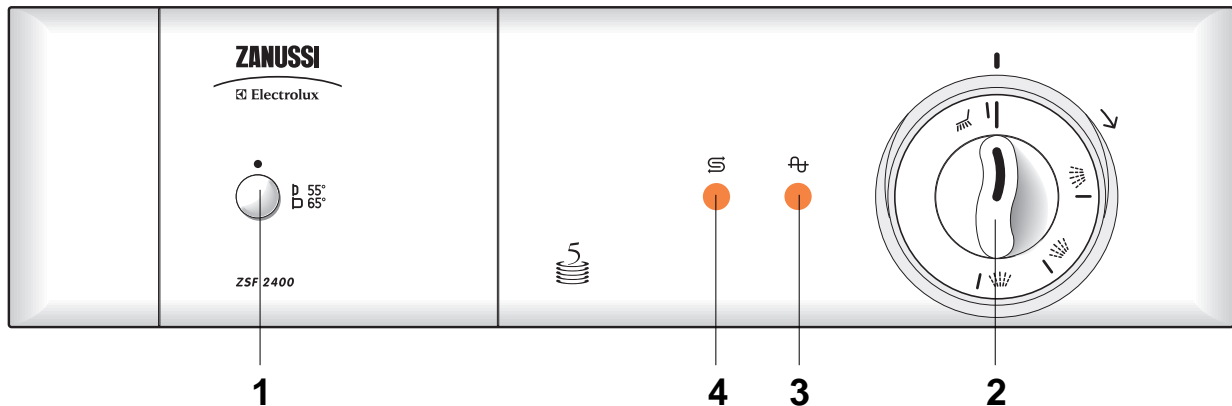

## 1 Temperature selector

55° - Button in  
65° - Button out

## 2 Programme knob

To start the machine:  
Turn the selector knob clockwise to the programme start. The On/Off switch is built into the programme timer. To isolate the dishwasher from the mains completely, unplug it from the wall socket.

**i** During the water heating process, the timer is standing still.

## 3 Indicator lamp

While the programme is in progress, the indicator lamp is lit and it goes out when the programme has finished.

## 4 Salt indicator lamp

The operating lamp indicates when the salt needs to be replenished. The lamp may remain lit for one or more programmes after refilling the salt container, this is normal.

 Wash phase

 Rinse phase

## Door lock

Press the handle down and open the door. Avoid opening the door while the machine is running, steam and hot water could escape from the machine which may cause an injury. If the door is opened slightly after a completed programme the dishes will dry faster.

# How to load the dishwasher

The illustration shows the machine loaded with five place settings. Your own dishes are not likely to be identical to this load, but if you follow the advice below we are sure you will be pleased with the results.

- Always place glasses, cups and bowls upside down.
- Incline deep dishes (soup plates etc.) so that the water can run off when drying.
- Make sure that the dishes do not rest against each other. This is particularly important in regard to the cutlery basket - nested spoons, etc. simply cannot be properly washed. The water must reach all the soiled surfaces.
- Make sure that cutlery with slender handles and other items do not protrude through the openings in the basket and prevent the spray arm from rotating.
- Never put silver and stainless steel objects together. When these metals come into contact with each other a chemical reaction occurs which stains the silver.
- China with a pattern applied on top of the glaze may not be suitable for machine washing as the colours may fade and lose their lustre. The same applies to cutlery with wooden or plastic handles.

**i** Make sure you always buy articles that are dishwasher proof.

- Not all plastic articles are machine washable. If you are in doubt as to whether your plasticware can be machine washed, we suggest you check by washing a single item or else wash them by hand.
- Aluminium becomes dull and tarnished when machine washed. The machine gets it clean, but at the expense of its appearance.
- When washing delicate items, select the lower wash temperature.
- Substances such as ketchup containing strong colouring agents can cause temporary discolouration in the machine.

1

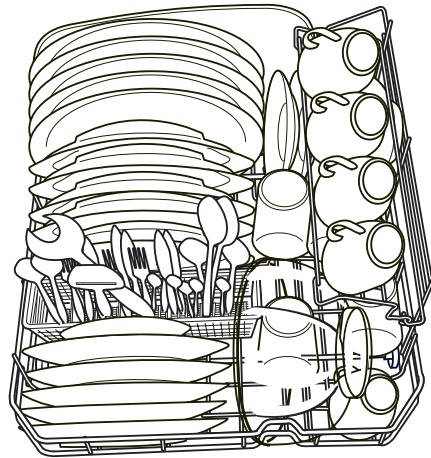

**Do not place sharp knives with their points upwards. It is much safer to lay them horizontally in the basket.**

2

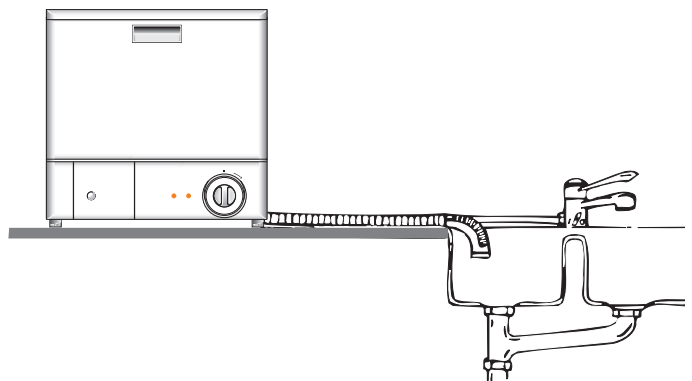

## Instruction for test centres

Test standard:	EN 50242
Rated capacity:	5 place settings
Loading of rack:	According to figure 1
Test program:	Normal 65° C
Detergent (IEC type B):	15 gram in the dispenser
Rinse aid (typ III):	Setting medium
Feed water pressure:	Minimum 0,8 bar, maximum 10 bar
Waste water outlet:	Install according to figure 2

The salt container and rinse aid dispenser shall be filled in accordance with the instruction manual. Before conducting the measurements the dishwasher shall be operated for one or two complete cycles using detergent and a clean load.

# Using your appliance

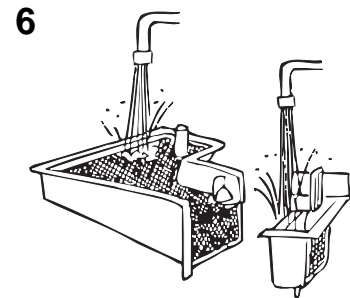
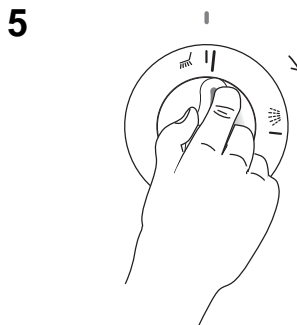
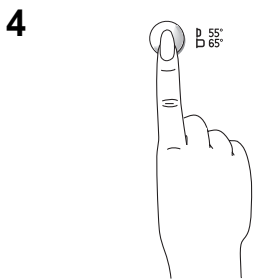
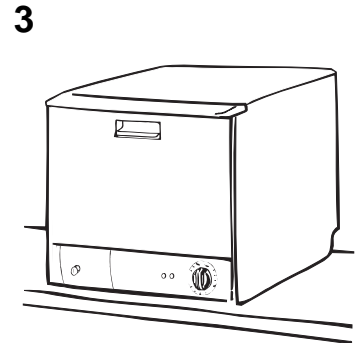
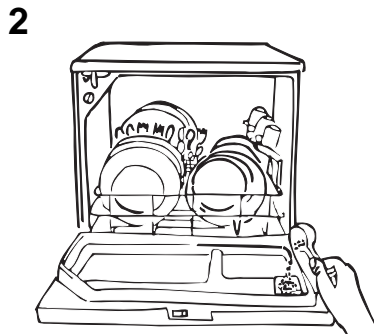
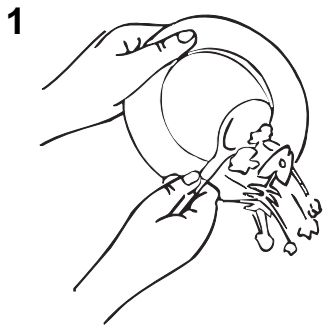

## Proceed as follows:



1. Scrape off solid food remnants.
2. Load the dishwasher. (See "How to load the dishwasher").  
Pour approx. 15 g detergent into the detergent dispenser.
3. Close the door.
4. Select the required temperature.
5. Start the dishwasher by turning the programme knob to the start position.
6. Check the filters to see whether they need cleaning when the dishwasher has finished the wash.

## Detergent recommendations



For best results we recommend the use of Finish detergents, rinse aid and salt.



A complimentary sample pack is included in your new dishwasher.



# Something Not Working?

Before calling out an engineer, please check through the details below because some faults can be rectified easily without the need to call out an engineer. If an engineer is called to resolve a problem listed below or to repair a fault caused by incorrect installation or mis-use a charge will be made, even if the appliance is under guarantee.

Fault	Check
<b>The machine will not start.</b>	<ul style="list-style-type: none"> <li>■ Is the door closed properly?</li> <li>■ Is there power to the machine?</li> <li>■ Has the fuse blown? (Start with fuse in electrical plug).</li> <li>■ Have you set the programme knob properly?</li> <li>■ Is the water tap turned on?</li> </ul>
<b>The machine is not filling with water.</b>	<ul style="list-style-type: none"> <li>■ Is the water tap turned on?</li> <li>■ Has your domestic water supply been cut off temporarily?</li> <li>■ Is the water intake hose kinked or squashed?</li> <li>■ Is the filter inside the intake hose blocked?</li> <li>■ Is the water pressure too low?</li> </ul>
<b>The machine will not drain.</b>	<ul style="list-style-type: none"> <li>■ Did you open the door before the light went out and the cycle ended?</li> <li>■ Is the drain hose kinked?</li> <li>■ Is the sink drain blocked?</li> </ul>
<b>Dishes not washed satisfactorily.</b>	<ul style="list-style-type: none"> <li>■ Are the baskets too full?</li> <li>■ Have the dishes not been arranged properly?</li> <li>■ Has anything prevented the spray arm from rotating?</li> <li>■ Are the spray arm holes clogged?</li> <li>■ Are the filters clogged?</li> <li>■ Are the filters fitted correctly?</li> <li>■ Did you use enough detergent?</li> <li>■ Is the detergent old or has gone hard?</li> <li>■ Is the salt container cap properly closed?</li> <li>■ Is the washing programme selected too gentle?</li> <li>■ Is the rinse aid dispenser empty?</li> </ul>
<b>Visible lime deposits or white film on the dishes.</b>	<ul style="list-style-type: none"> <li>■ Is the salt container empty or is the water softener not correctly adjusted?</li> <li>■ Is the rinse aid dispenser adjusted to too low dosage?</li> </ul>
<b>The machine is noisy.</b>	<ul style="list-style-type: none"> <li>■ Are the dishes rattling against each other?</li> <li>■ Is the spray arm knocking against the dishes?</li> </ul>
<b>The dishes are not quite dry.</b>	<ul style="list-style-type: none"> <li>■ Is the rinse aid dispenser empty?</li> <li>■ Have the dishes been left too long inside the machine?</li> </ul>
<b>The door is difficult to close.</b>	<ul style="list-style-type: none"> <li>■ Is the dishwasher level?</li> </ul>



**Never attempt to repair the dishwasher yourself.  
Repairs carried out by unauthorised or inexperienced  
persons can cause injury or serious malfunctioning.**

## Service and Spare Parts

In the event of your appliance requiring service, or if you wish to purchase spare parts, please contact your local Service Force Centre by telephoning:

**08705 929929**

Your telephone call will be automatically routed to the Service Force Centre covering your post code area.

For the address of your local Service Force Centre and further information about Service Force, please visit the website at [www.serviceforce.co.uk](http://www.serviceforce.co.uk)

For Customer Service in Ireland please contact us at the address below:

Zanussi Electrolux  
Electrolux Group (Irl) Ltd  
Long Mile Road  
Dublin 12  
Republic of Ireland  
Tel: + 353 (0)1 4090751  
Email: [service.eid@electrolux.ie](mailto:service.eid@electrolux.ie)

Before calling out an engineer, please ensure you have read the details under the heading "Something Not Working".

When you contact the Service Force Centre you will need to give the following details:

1. Your name, address and post code
2. Your telephone number
3. Clear and concise details of the fault
4. The model and serial number of the appliance (found on the rating plate affixed to the rear of the dishwasher).
5. The purchase date

**Please note that a valid purchase receipt or guarantee documentation is required for in-guarantee service calls.**

## Customer Care Department

For general enquiries concerning your Zanussi Electrolux appliance or for further information on Zanussi Electrolux products, please contact our Customer Care Department by letter or telephone at the address below or visit our website at [www.zanussi.co.uk](http://www.zanussi.co.uk)

Major Appliances Customer Care Department  
Zanussi Electrolux  
Addington Way  
Luton  
Bedfordshire  
LU4 9QQ  
Tel: 08705 727727 \*

\* call to this number may be recorded for training purposes.

# Guarantee Conditions

## Standard guarantee conditions

We, Zanussi Electrolux, undertake that if within 12 months of the date of the purchase this ZANUSSI ELECTROLUX appliance or any part thereof is proved to be defective by reason only of faulty workmanship or materials, we will, at our option repair or replace the same FREE OF CHARGE for labour, materials or carriage on condition that:

- The appliance has been correctly installed and used only on the electricity supply stated on the rating plate
- The appliance has been used for normal domestic purposes only and in accordance with the manufacturer's instructions
- The appliance has not been serviced, maintained repaired, taken apart or tampered with by any person not authorised by us
- All service work under this guarantee must be undertaken by a Zanussi Electrolux Service Force Centre
- Any appliance or defective part replaced shall become the Company's property
- This guarantee is in addition to your statutory and other legal rights

Home visits are made between **8.30am** and **5.30pm** Monday to Friday. Visits may be available outside these hours in which case a premium will be charged.

## Exclusions

**This guarantee does not cover:**

- Damage or calls resulting from transportation, improper use or neglect, the replacement of any light bulbs or removable parts of glass or plastic
- Costs incurred for calls to put right an appliance which is improperly installed or calls to appliances outside the United Kingdom
- Appliances found to be in use within a commercial environment, plus those which are the subject to rental agreements
- Products of Zanussi Electrolux manufacture which are not marketed by Zanussi Electrolux

## European Guarantee

If you should move to another country within Europe then your guarantee moves with you to your new home subject to the following qualifications:

- The guarantee starts from the date you first purchased your product
- The guarantee is for the same period and to the same extent for labour and parts as exists in the new country of use for this brand or range of products
- This guarantee relates to you and cannot be transferred to another user
- Your new home is within the European Community (EC) or European Free Trade Area
- The product is installed and used in accordance with our instructions and is only used domestically, i.e. a normal household
- The product is installed taking into account regulations in your new country

Before you move please contact your nearest Customer Care centre, listed below, to give them details of your new home. They will then ensure that the local Service Organisation is aware of your move and able to look after you and your appliances.

France	Senlis	+33 (0)3 44 62 29 99
Germany	Nurnberg	+49 (0)800 234 7378
Italy	Pordenone	+39 (0)0434 39 4700
Sweden	Stockholm	+46 (0)8 672 53 90
UK	Luton	+44 (0)8705 727727
Ireland	Dublin	+353 (0)1 4090751

# Installation instructions

 Any electrical work required to install this appliance should be carried out by a qualified electrician or competent person.

 Any plumbing work required to install this appliance should be carried out by a qualified plumber or competent person.

## Technical specifications

<b>Dimensions</b>	Height	460 mm
	Width	450 mm
	Depth	480 mm
<b>Weight</b>	Net	17 kg
	Gross	20 kg
<b>Capacity</b>		5 settings
<b>Water pressures</b>	Minimum	50 kPa (0.5 bar)
	Maximum	1000 kPa (10 bar)
<b>Water Temperature</b>	Cold water fill only	
<b>Electrical data</b>	Power supply	230 V - 50 Hz
	Fuse	13 A
	Heating element	1200 W
	Power rating	1280 W

 This appliance complies with the following E.E.C. directives:

- 73/23/EEC, dated 19.02.1973 – low-voltage directive.
- 89/336/EEC, dated 03.05.1989 (incl. amendment
- 92/31/EEC) – directive on electromagnetic compatibility.

# Unpacking the machine

## If the machine is damaged

If the dishwasher has been damaged during transport, you should immediately notify the company responsible for delivering it.

Check that the dishwasher is undamaged. If you discover any damage, faults or that anything is missing, you should notify the dealer immediately.



Never leave packaging material in a place where children may play with it. **Risk of suffocation!**

Check that the following accessories are supplied with the dishwasher when you unpack it:

- A funnel for filling with salt (1)
- Elbow for discharge hose (2)

## Use

This dishwasher is designed solely for washing household utensils suitable for washing in a dishwasher. Using it for other purposes may damage it and invalidate the guarantee.

## Protecting the machine against freezing

If the dishwasher is placed in an environment where the temperature sometimes falls below 0° C, there is a risk that the small amount of water which remains inside the parts of the dishwasher will freeze and damage it.

To prevent this you should:

1. Turn off the water supply to the machine and disconnect the water intake hose from the supply pipe.
2. Make sure that there is dishwasher salt in the salt container for the water softener.



The appliance is only to be used and stored indoors at normal room temperature. The manufacturer accepts no responsibility for any frost damage.

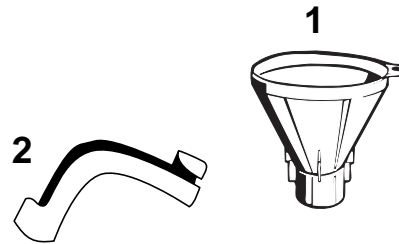
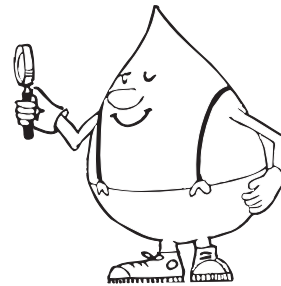

# Installation

The dishwasher is intended for installation on a kitchen drainer or worktop. It is important to ensure the dishwasher is level to avoid any difficulty opening and closing the door. Its height can be adjusted with the adjustable feet (8 mm each) in each corner of the dishwasher.

## Water inlet

The dishwasher should be permanently plumbed into a separate cold water supply.

The water pressure must be within the limits given in the technical specifications, as it will not function correctly if pressure is outside these specifications.

Your local Water Authority will advise you on the average mains pressure in your area. Where the water is supplied from a cold water cistern you can work out the pressure yourself by measuring the vertical distance (or 'Head') between the machine's inlet hose and the outlet from the cold water storage cistern; allowing .86 psi for every 2 feet under normal conditions.

We would advise you to have a shut-off valve or stopcock in the water supply pipe close to the dishwasher and accessible for easy use. This should be turned off when the appliance is not in use. Connect the inlet hose to a tap with a 3/4" pipe thread.

The inlet hose must not be joined onto any form of extension hose. If it is too short, the entire hose must be replaced with a longer high-pressure hose, specially designed for the purpose. The end of the hose, which is connected to the dishwasher can be turned in any direction. Loosen the retaining nut, turn the hose, then retighten the nut.

 **Check that the nut and all other connections are tight before the machine is moved into position.**

 **Use only the inlet hose supplied to the dish-washer. Do not reuse an inlet hose used with a previous machine.**

## Water drainage

Place the discharge hose over the sink as illustrated. It must not at any point be higher up than 75 cm over the surface which the dishwasher is standing on. If it runs higher, operation of the dishwasher might be impaired.

It is also important to ensure that the inside diameter of the hose is not less than 13 mm at any point. If the discharge hose is too long it can easily be cut to the right length.

-  1. Cut the hose to a suitable length, using a sharp knife.
2. Fit the elbow supplied onto the end of the hose.

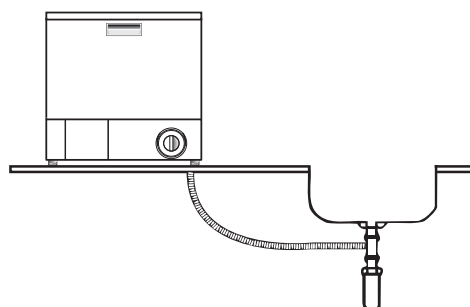
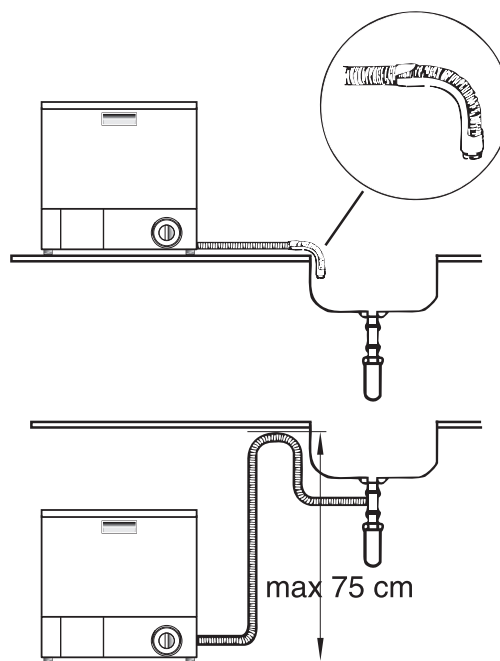
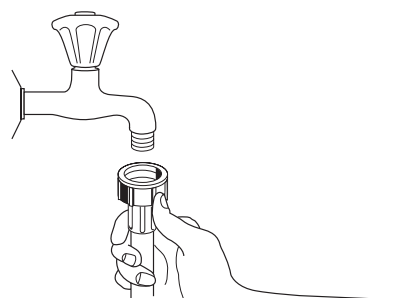
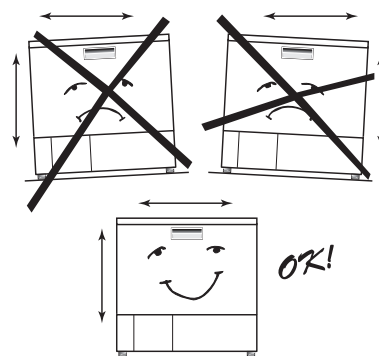

## Power supply

The dishwasher is supplied with a lead and electrical plug for connection to a 230 V, 13 A earthed wall socket. Before any work is carried out on the dishwasher, it must be isolated from the electric mains supply, for example by removing the plug from the wall socket.



**Permanent electrical installation must be carried out by an authorised electrician or competent person.**

**WARNING: THIS APPLIANCE MUST BE EARTHED.**

**The manufacturer declines any liability should this safety measure not be observed.**

**The appliance should not be connected to the electrical supply by means of an extension cable.**

If the plug that is fitted to your appliance is not suitable for your socket outlet, it must be cut off and the appropriate plug fitted.

Remove the fuse from the cut off plug.

**Important:** The plug must still be accessible after the appliance has been installed.

### Important

The wires in the mains lead are coloured in accordance with the following code:

<b>Green and Yellow</b>	- Earth
<b>Blue</b>	- Neutral
<b>Brown</b>	- Live

If you fit your own plug, the colours of the wires in the mains lead of your appliance may not correspond with the markings identifying the terminals in your plug, proceed as follows:

Connect the Green and Yellow (earth) wire to the terminal in the plug which is marked with the letter «E» or the earth symbol  or coloured green and yellow.

Connect the blue (neutral) wire to the terminal in the plug which is marked with the letter «N» or coloured black.

Connect the brown (live) wire to the terminal in the plug which is marked with the letter «L» or coloured red.

The plug moulded onto the lead incorporates a fuse.

For replacement, use a 13 amp BSI362 fuse.

Only ASTA or BSI approved fuses should be used.

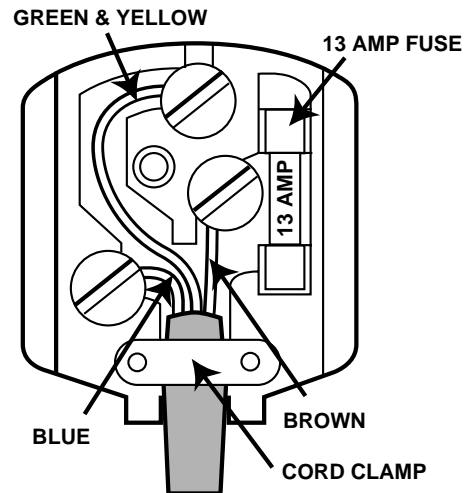

**Warning! A cut off plug inserted into a 13 amp socket is a serious safety (shock) hazard. Ensure that the cut off plug is disposed of safely.**

**ZANUSSI**

 **Electrolux**

© Electrolux plc 2005

 **From the Electrolux Group. The world's No. 1 choice.**

*The Electrolux Group is the world's largest producer of powered appliances for kitchen, cleaning and outdoor use. More than 55 million Electrolux Group products (such as refrigerators, cookers, washing machines, vacuum cleaners, chain saws and lawn mowers) are sold each year to a value of approx. USD 14 billion in more than 150 countries around the world.*



Technical changes possible

**AGB** 05-06



## Free Manuals Download Website

<http://myh66.com>

<http://usermanuals.us>

<http://www.somanuals.com>

<http://www.4manuals.cc>

<http://www.manual-lib.com>

<http://www.404manual.com>

<http://www.luxmanual.com>

<http://aubethermostatmanual.com>

Golf course search by state

<http://golfingnear.com>

Email search by domain

<http://emailbydomain.com>

Auto manuals search

<http://auto.somanuals.com>

TV manuals search

<http://tv.somanuals.com>