

# ZANUSSI

 Electrolux

## DISHWASHER ZSF 2420

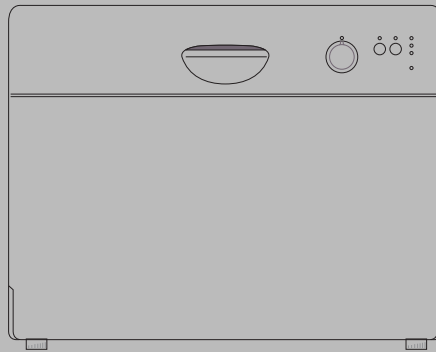

# Contents

## For the user

<b>Safety Information</b>	<b>3</b>
<b>Description of the appliance</b>	<b>4-5</b>
- Spray arm	
- Coarse strainer/microfilter	
- Fine filter	
- Detergent dispenser	
- Rinse aid dispenser	
- Water softener	
<b>The control panel</b>	<b>6</b>
- How to set the delayed start	
<b>Adjusting the water softener</b>	<b>7</b>
<b>Programme chart</b>	<b>8</b>
<b>Loading and unloading</b>	<b>9</b>
<b>Using the appliance</b>	<b>10</b>
- Starting the programme	
- Interrupting the programme temporarily	
- Cancelling the programme	
- Cancelling the drying phase	
- Switching the dishwasher off	
<b>Maintenance and cleaning</b>	<b>11</b>
<b>Something Not Working</b>	<b>12-13</b>
<b>Service</b>	<b>13</b>
- Service and Spare Parts	
- Customer Care Department	
<b>Guarantee Conditions</b>	<b>14</b>

## For the Installer

<b>Technical Specifications</b>	<b>15</b>
<b>Unpacking</b>	<b>16</b>
- Damages	
- Use	
- Positioning	
<b>Installation</b>	<b>17-18</b>
- Water inlet	
- Water drainage	
- Power supply	
<b>Information for test centres</b>	<b>19</b>

## Guide to use the instruction book

The following symbols will be found in the text to guide you throughout the instructions:



**Safety information**



**Step by step instructions**



**Hints and tips**



**Environmental information**

# Safety information

Before installing and first using the dishwasher, read this instruction booklet carefully, including its hints and warnings. To avoid unnecessary mistakes and accidents, it is important to ensure that all people using the dishwasher are thoroughly familiar with its operation and safety features. Save these instructions and make sure they remain with the dishwasher if it is moved or sold, so that everyone using it through its life can be properly informed on appliance use and safety.

## Installation and servicing

- All installation and service work done on the product must be carried out by a qualified technician. Work performed by persons with inadequate knowledge may adversely affect the satisfactory functioning of the product and may cause personal injury or damage. Before any work is carried out on the dishwasher, it must be isolated from the electrical supply. To do this the power plug must be removed from the wall socket.
- Water connection should be made via an easily accessible tap.
- The power cable must be plugged into an earthed socket, which must to be easily accessible. Permanent installation must only be carried out by an authorised electrician or competent person.
- If the power cable is damaged, it must be replaced by a Service Force engineer. Please contact your local service centre on 08705 929 929.
- Make sure that the power cable is not nipped or otherwise damaged and that the hoses do not get crushed or kinked when moving the dishwasher when installing or cleaning etc.
- Servicing and possible repairs must be carried out by a Service Force engineer. Always insist on genuine spare parts. Never try to repair the dishwasher yourself.

## Child Safety

- The dishwasher should be used by adults only. Do not let children play with the controls or other parts of it.
- Do not allow children to play with the packaging. Risk of suffocation.
- Keep all detergents in safe place out of children's reach.
- Prevent children from sitting, swinging or standing on the open door.

## During Use

- This dishwasher is designed solely for washing household utensils suitable for machine washing. Using it for other purposes could lead to physical injury or damage to property and invalidate the guarantee.
- Avoid opening the door while the dishwasher is running, as hot steam may escape.
- Only use detergent specifically designed for use in dishwashers.
- Do not place sharp knives with their points upwards. It is much safer to lay them horizontally in the basket.

- Ensure that the door of the dishwasher is always closed when it is not being loaded or unloaded. In this way you will avoid anybody injuring themselves on the open door.
- If you take any dishes out of the dishwasher before the end of the dishwashing cycle, it is extremely important to rinse them thoroughly under running water to remove any remaining detergent.
- The water safety system protects against water damages. The following requirements must be fulfilled:
  - The dishwasher must be electrically connected when it is switched off.
  - The dishwasher must be correctly installed.
  - Always shut off the water supply whenever the dishwasher is left unattended for an extended period.
- In the event of flooding or leakage, switch off the water supply immediately by closing the stopcock and disconnect the power supply by unplugging the power cable or removing the fuse. When removing the electrical plug, grip the plug, not the cable. **Never touch the switch or plug with wet hands!**

## Conservation

### - packaging:

All materials used in packaging this appliance are environmentally-friendly. The various plastics used are identified and can be recycled:

- PE stands for polyethylene, which is used for the bag around the appliance and the bag in which these instructions were supplied.
- PS stands for polystyrene (moulded), which is used for the sections of packaging needed to cushion the appliance.

The cardboard components of the packaging are made from recyclable paper and should be taken to a collection point for recycling.

### - old apparatus:

The symbol  on the product or on its packaging indicates that this product may not be treated as household waste. Instead it shall be handed over to the applicable collection point for the recycling of electrical and electronic equipment. By ensuring this product is disposed of correctly, you will help prevent potential negative consequences for the environment and human health, which could otherwise be caused by inappropriate waste handling of this product. For more detailed information about recycling of this product, please contact your local city office, your household waste disposal service or the shop where you purchased the product.

# Description of the appliance

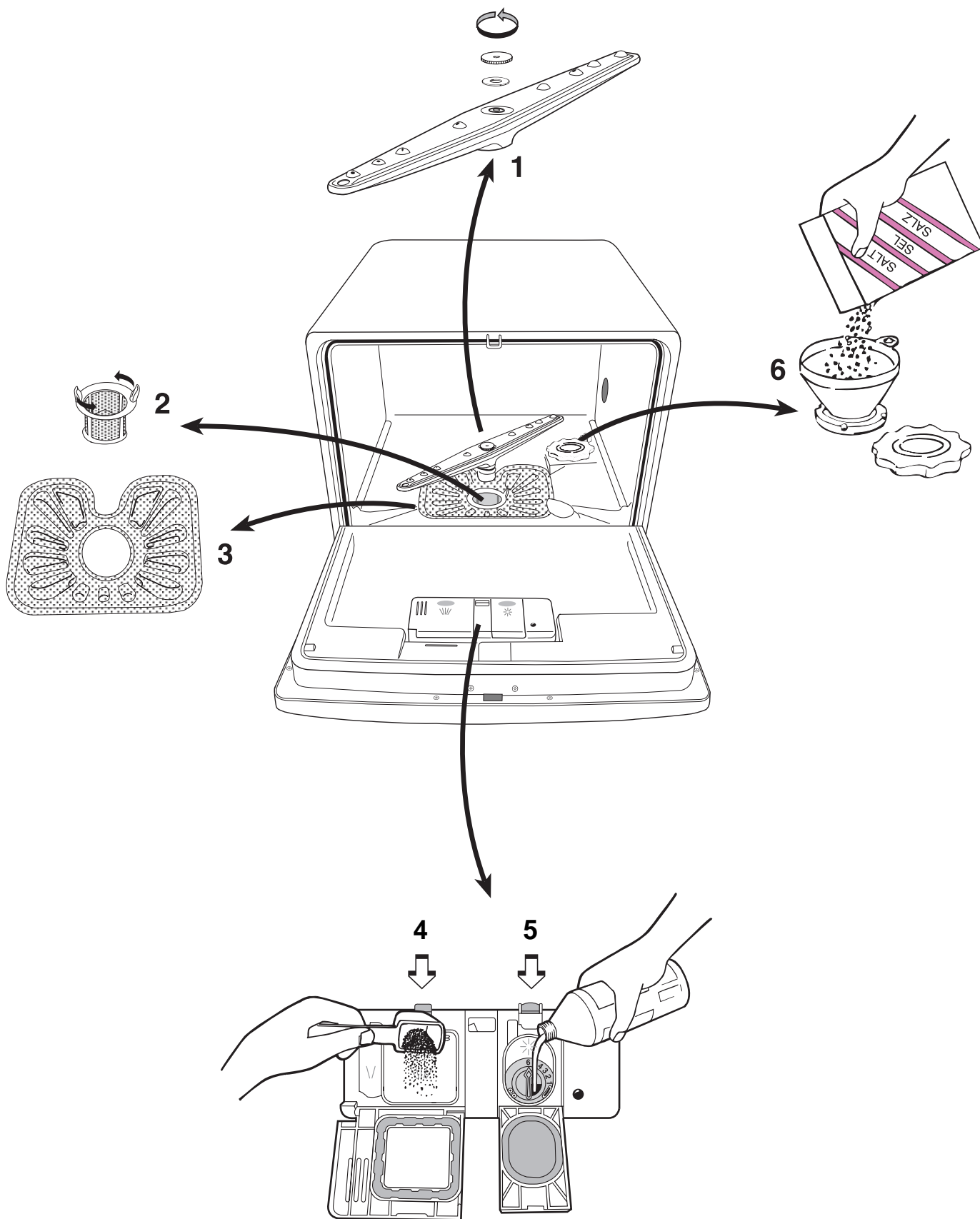

## Spray arm (1)

It is important to keep all the holes in the spray arm clear. A clogged hole can seriously affect washing efficiency. If the spray arm needs cleaning, unscrew the nut anti-clockwise, remove the washer and lift off the spray arm. Clear the holes and shake out any food remnants.

## Coarse strainer/microfilter (2)

The purpose of the coarse strainer is to catch large objects such as a cocktail stick and pieces of eggshell. Make sure that the strainer is always clean. Turn the coarse strainer anti-clockwise. Lift it out and rinse it under running water whenever necessary.

## Fine filter (3)

It is just as important to keep this filter clean. A dirty or clogged filter will always impair washing efficiency. The fine filter can easily be lifted out for cleaning when you have removed the coarse strainer.

## Detergent dispenser (4)

Open the lid to the dispenser by pressing the lid catch towards the compartment. Consult the instructions on the detergent packet, fill the compartment accordingly and close the lid. Remember that the instructions usually refer to full-size dishwashers, for example when using detergent tablets, it is sufficient to use just half a tablet. Pre-wash detergent is poured into the smaller compartment to the left when needed. This detergent is used during the pre-rinsing. Make sure that nothing prevents the lid from opening.



**Only use detergents specially designed for dishwashers.**

## Rinse aid dispenser (5)

Use of rinse aid will result in cleaner and faster drying of the load, since it helps water and residues to run off. Too much rinse aid may result in streakiness, too little may cause white spots. The dispenser holds about 150 ml. This is enough for approx. 60 wash cycles, depending on the dosage setting. Adjust the dosage setting according to the hardness of the water.



You can set the dosage between 1 - 6, the appliance is factory set to 1. Begin at the lowest dosage setting and increase if necessary by turning the setting arrow with e.g. the handle of a spoon.

The amount of rinse aid can be checked through the lens on the dispenser. When the lens is clear, requires refilling of rinse aid.



1. Open the lid to the dispenser by pressing the lid catch towards the compartment and lift the lid.
2. Fill up with rinse aid; do not overfill.

3. Wipe off any spillage carefully to prevent excessive foaming during the next wash programme.
4. Close the lid and press until it locks again.



**Do not fill the rinse aid dispenser with liquid detergent.**



Zanussi recommends the use of Finish dishwasher detergent and Rinse Aid.

## Water softener (6)

This dishwasher is equipped with a water softener for hard water. The lime in hard water causes white deposits to occur on dishes and to the interior of the dishwasher. To prevent this, the water has to pass through a special container where the hardness is removed. Since the water softener uses dishwasher salt, you will have to refill the salt container after a certain number of dishwasher cycles.



**It is extremely important, that the salt container is filled up with the dishwasher salt before using the dishwasher for the first time.**

The  indicator light on the control panel is lit when the container requires refilling.



1. Unscrew the filler cap to the salt container anti-clockwise.
2. Fill the salt container with water (only the first time).
3. Fill the container with dishwasher salt, using the funnel supplied.
4. Remove the funnel and wipe off any spillage around the filler opening.
5. Screw the filler cap back properly in place.

The water softener is now ready for the first load of dishes. Always make sure that there is dishwasher salt in the container, which holds about 1 litre. How to adjust the water softener, see chapter "Adjusting the water softener".



**Only use special salt for dishwashing machines, ordinary domestic salt, especially table salt, can damage the water softener.**

# The control panel

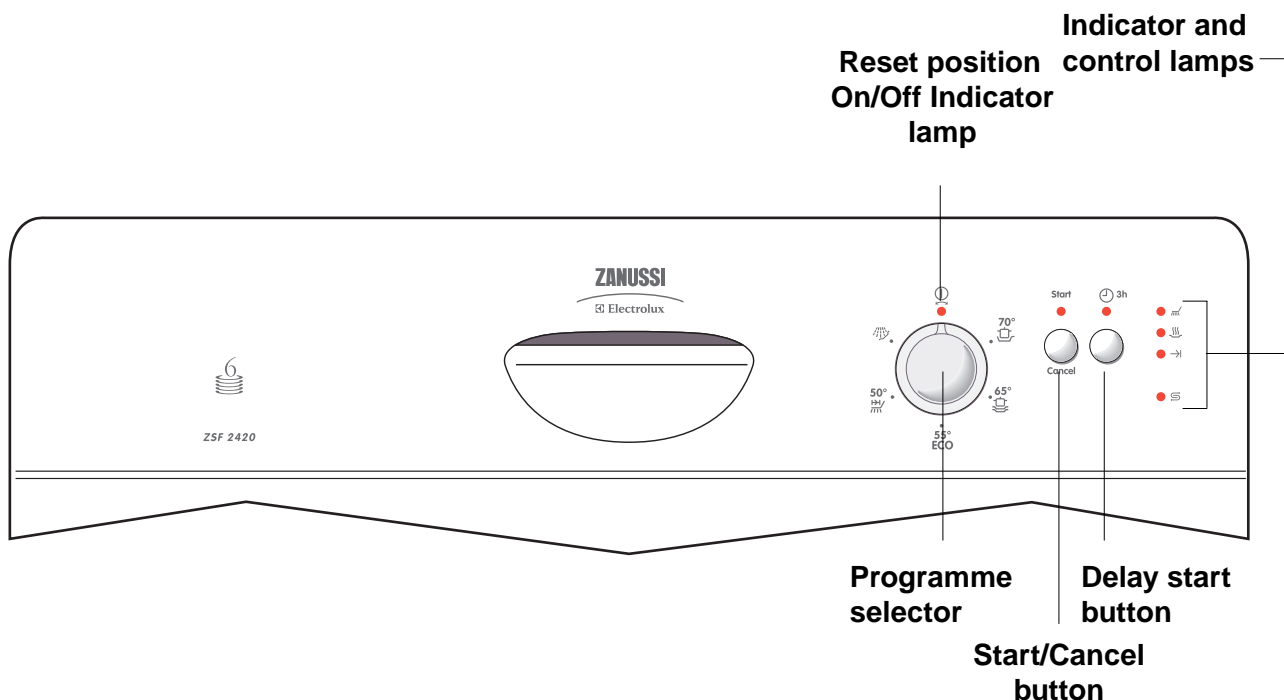

## Programme selector

Turn the programme selector clockwise or anticlockwise to select the programme and temperature according to the programme chart.



## Start/Cancel button

In addition to starting a programme you can, by pressing this button, adjust the setting of the water softener and cancel a programme in progress.

⌚ = reset position

## Indicator lamps:

Shows current phase of the selected programme.

- Wash cycle in progress  top lamp
- Drying in progress  middle lamp
- Programme cycle ended  lowest lamp

## Control lamp:

Shows that refilling of salt container is necessary

## How to set the delayed start

The programme start can be delayed by 3 hours.

1. Select the desired dishwashing programme. The programme indicator lamps starts to flash.
2. Press the delay start button. The lamp for the delayed start lights up.
3. Press the start button. The programme indicator lamps goes out. The programme will start when 3 hours have elapsed.

## Cancelling the delayed start:

Press the delay start button, the lamp for the delayed start goes out. The required programme starts immediately.

# Adjusting the water softener

To prevent limescaling on the dishes and to the interior of the dishwasher, the dishes must be washed with soft water.

This dishwasher is equipped with a water softener, where tap-water which is harder than 4 °d (german degree) is softened.

Adjust the water softener according to the table below for the water hardness level for your area.

 Contact your local Water Authority to find the exact water hardness level for your area.

The water softener has 10 settings:

Water hardness level		Setting on the water softener	Number of light flashes
°d 1)	mmol/l 2)		
> 24	> 4,2	10	10
22 - 24	3,9 - 4,2	9	9
20 - 22	3,6 - 3,9	8	8
18 - 20	3,2 - 3,6	7	7
16 - 18	2,8 - 3,2	6	6
13 - 16	2,3 - 2,8	5 *	5
10 - 13	1,8 - 2,3	4	4
7 - 10	1,2 - 1,8	3	3
4 - 7	0,7 - 1,2	2	2
below 4	below 0,7	1 no salt is needed	1

1) german degree of measurement for the water hardness

2) millimol, international unit for water hardness

\*) factory setting





 In the following settings the dishwasher must be switched off and all programmes completed. See chapter "Using the appliance" for information on how to complete the programme.

-  1. Press the start button and hold it pressed in.
2. Turn the programme selector clockwise to the first programme. When the indicator for the start button and for the ended programme cycle starts to flash, you can release the start button.
  - The number of flashes for the ended programme cycle are equivalent to the set water hardness level.
  - This sequence of flashes is repeated several times after a few seconds pause.
3. The water hardness level is raised by 1 step every time you press the start button.

After hardness level 10 comes hardness level 1.
4. Turn the programme selector to the "Reset" position when the required water hardness level is selected. This saves the required setting.

If the setting 1 is chosen, the salt indicator lamp is not lit.

# Programme chart

Type of dishes	Plates and cooking pots	All types of dishes		Coffee cups, delicate items	All types of dishes
<b>Type of soil:</b>	<ul style="list-style-type: none"> <li>heavily soiled</li> <li>dried-on food remnants especially egg-white and starch</li> </ul>	<ul style="list-style-type: none"> <li>normally soiled</li> <li>dried-on food remnants</li> </ul>	<ul style="list-style-type: none"> <li>normally soiled</li> </ul>	<ul style="list-style-type: none"> <li>lightly soiled</li> </ul>	<ul style="list-style-type: none"> <li>3)</li> </ul>
<b>Suitable programme:</b>	↓	↓	↓	↓	↓
	 <b>INTENSIVE</b> 70° C	 <b>NORMAL</b> 65° C	<b>ECO</b> <b>ENERGY SAVE</b> 55° C 2)	 <b>QUICK</b> 50° C	 <b>PRERINSE</b> -
<b>Programme cycle:</b>	Pre-wash Washing 2 x rinses Final rinse Drying	Pre-wash Washing Rinse Final rinse Drying	Pre-wash Washing Rinse Final rinse Drying	- Washing Rinse Final rinse -	Prerinse - - - -
<b>Consumption figures: 1)</b>	↓	↓	↓	↓	↓
<b>Washing time with drying:</b>	117 minutes	94 minutes	159 minutes	36 minutes	7 minutes
<b>Drying time:</b>	13 minutes	13 minutes	54 minutes	—	—
<b>Energy:</b>	1,15 kWh	0,80 kWh	0,63 kWh	0,40 kWh	0,01 kWh
<b>Water:</b>	9 litres	8 litres	8 litres	7 litres	1,8 litres

1) Consumption figures have been calculated for nominal conditions. The figures can vary depending on inlet water temperature and how full the main and cutlery basket are.

2) Consumption figures and performance is according to the Energy Save programme cycle.

3) Prerinse is used if you want to wait until you have a full load. This cycle rinses the load and keeps it moist, making the main wash easier later on. No detergent should be used.



All programmes begin with a drain.



**Dishwashing detergent in tablet form is not suitable for use in the Quick programme cycle because some tablets cannot develop their full cleaning power during short programmes.**



# Loading and unloading the dishwasher

## How to load the dishes

The illustration shows the dishwasher loaded with six place settings. Your own dishes are not likely to be identical to this load, but if you follow the advice below we are sure you will be pleased with the results.

- Always place glasses, cups and bowls upside down.
- Incline deep dishes (soup plates etc.) so that the water can run off when drying.
- Make sure that the dishes do not rest against each other. This is particularly important in regard to the cutlery basket - nested spoons, etc. simply cannot be properly washed. The water must get at all the soiled surfaces.
- Make sure that cutlery with slender handles and other items do not protrude through the openings in the basket and prevent the spray arm from rotating.
- Never put silver and stainless steel objects together. When these metals come into contact with each other a chemical reaction occurs which stains the silver.
- China with a pattern applied on top of the glaze may not be suitable for machine washing as the colours may fade and lose their lustre. The same applies to cutlery with wooden or plastic handles.

**i** Make sure you always buy articles that are dishwasher proof.

- Silver and aluminum items tend to discolour when washed. Food remnants from egg and mustard often causes discolourations and stains on silver. Make sure to rinse off and remove food remnants on silver if it is not washed immediately after it has been used.
- Not all plastic articles are machine washable. If you are in doubt as to whether your plasticware can be machine washed, we suggest you check by washing a single item or else wash them by hand.
- When washing delicate items, select the programme with the lower wash temperature.
- Substances such as ketchup containing strong colouring agents can cause temporary discolouration to the interior of the dishwasher.

**!** **Do not place sharp knives with their points upwards. It is much safer to lay them horizontally in the main basket.**

## Unloading

Hot dishes are sensitive to knocks. Always let the dishes cool down before unloading.

**i** The dishes dry faster if the door is opened slightly for a short time once the programme has finished.

**!** **Use care when opening the door as hot steam may escape.**

## Baskets

Main basket

Cutlery basket

**i** The cup shelves can be placed in two different levels.

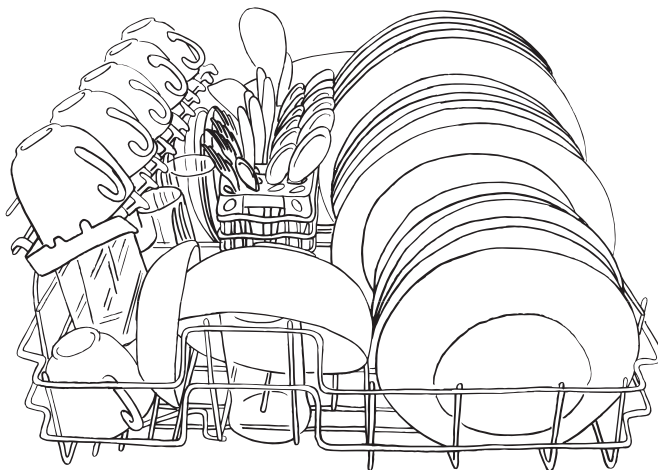

# Using the appliance

## Starting the programme

-  1. Scrape or rinse off solid food remnants.
2. Load the dishwasher.  
(See the basket and loading).
3. Put the correct amount of detergent into the detergent dispenser and close the dispenser lid.
4. Close the door.
5. Select the required programme (see programme chart). The programme indicator lamps starts to flash.
6. Press in the start button. The lamp for the start button comes on and dishwashing cycle starts. The programme indicator lamps always indicates which part of the selected cycle the dishwasher is in.
7. Check the filters to see if they need to be cleaned when the dishwasher has finished the programme.

## Interrupting the programme temporarily

-  1. Open the door. The programme stops.
2. Close the door and the programme continues after about six seconds.

 **Open the door carefully when the dishwasher is running, since hot steam may escape.**

## Cancelling the programme

-  1. Press and hold in the start button until the programme indicator lamps goes out.
2. Release the button, the programme indicator lamps starts to flash.
3. Turn the programme selector to the "Reset" position. The programme is now cancelled and a new programme can be selected.

 If you simply turn the programme selector to the "Reset" position, the selected programme is not finished, it is only disrupted. The programme will continue if you turn the programme selector to the programme again.

## Cancelling the drying phase

In case you do not want to wait until the drying phase is completed, you can cancel it.

-  1. Press and hold in the start button until the programme indicator lamps starts to flash, then release the button.
2. Open the door. The drying phase is cancelled.

## Switching the dishwasher off

Switch the dishwasher off, when the indicator lamp →| for the programme cycle end is lit.

-  1. Turn the programme selector to the "Reset" position. All indicator lamps goes out.



Leave the door slightly ajar.



**Be careful if you open the door immediately after the programme is finished, since hot steam may escape.**

# Maintenance and cleaning

## General cleaning

Inspect the filters and spray arm nozzle before re-loading the dishwasher and remove any food scraps. Wipe round the rubber gasket at the bottom of the door to remove grease which tends to collect there.

## Cleaning the filters

There are two filters, a coarse one and a fine one which should be cleaned after every wash. Lift out these filters which are in the base of the dishwasher and wash under running water.



**The dishwasher must not be used without the filters. Incorrect repositioning of the filters will produce poor washing results.**



Cleaning of the filters is vital to ensure correct operation of the dishwasher.

## Cleaning the spray arm

The holes in the spray arm must be kept free of scraps for the efficiency of the washing action. Inspect the spray arm regularly. When thorough cleaning is necessary, remove the spray arm by unscrewing the nut anti-clockwise, remove the washer and lift off the spray arm.

Wash the spray arm with hot soapy water using a stiff brush if necessary to remove scraps.

Re-assemble carefully, making sure the nut is secure.

## Cleaning the cabinet

Wipe the outside of the cabinet and control panel regularly with a soft damp cloth. When necessary, use washing up liquid to remove stubborn marks, rinse with a damp cloth and rub up with a soft duster.

Never use abrasive cleaners which could damage the surface, ie: scouring pads or solvents (acetone, trichloroethylene, etc).

**If the dishwasher is not going to be used for some time, take the following precautions:**



1. Unplug the dishwasher and turn off the water supply.
2. Fill up the rinse aid container.
3. Make sure the tub is clean by carrying out a wash programme (without any crockery) using Finish Dishwasher cleaner, then dry the inside thoroughly.
4. Leave the door ajar.

## Moving the dishwasher

If you have to move the dishwasher (you are moving house, etc):



1. Unplug it.
2. Turn off the water tap.
3. Remove the water inlet and discharge hoses.



**Avoid tilting the dishwasher during transportation.**

## Protecting the dishwasher against freezing



**If the dishwasher is placed in an environment where the temperature sometimes falls below 0° C, there is a risk that the small amount of water which remains inside the parts of the dishwasher will freeze and damage it. To prevent this you should:**



1. Turn off the water supply to the dishwasher.
2. Remove the water inlet and discharge hoses.
3. Make sure that there is dishwasher salt in the salt container for the water softener.



The appliance is only to be used and stored indoors at normal room temperature. The manufacturer is not responsible for any frost damage.

# Something Not Working

Before calling out an engineer, please check through the details below because some faults can be rectified easily without the need to call out an engineer. If an engineer is called to resolve a problem listed below or to repair a fault caused by incorrect installation or mis-use a charge will be made, even if the appliance is under guarantee.

Fault	Check
<b>The programme will not start.</b>	<ul style="list-style-type: none"> <li>• Is the door closed properly?</li> <li>• Have you pressed the start button?</li> <li>• Is the water tap turned on?</li> <li>• Is the dishwasher plugged in?</li> <li>• Has the fuse blown? (Start with fuse in electrical plug).</li> <li>• Is the delay start-button pressed in?</li> <li>• Is the previous programme finished? (See "Using the appliance").</li> </ul>
<b>The dishwasher is not filling with water.</b>	<ul style="list-style-type: none"> <li>• Is the water tap turned on?</li> <li>• Has your domestic water supply been cut off temporarily?</li> <li>• Is the water inlet hose kinked or squashed?</li> <li>• Is the filter inside the inlet hose blocked?</li> <li>• Is the water pressure too low?</li> </ul>
<b>Water not discharged at end of cycle.</b>	<ul style="list-style-type: none"> <li>• Did you open the door before the indicator light →  was lit and the programme cycle finished?</li> <li>• Is the previous programme finished? (See "Using the appliance").</li> <li>• Are the filters clogged?</li> </ul>
<b>Dishes not washed satisfactorily.</b>	<ul style="list-style-type: none"> <li>• Has anything prevented the spray arm from rotating?</li> <li>• Are the spray arm holes clogged?</li> <li>• Were the dishes packed too close together?</li> <li>• Are the filters clogged?</li> <li>• Are the filters fitted correctly?</li> <li>• Did you use enough detergent?</li> <li>• Is the salt container cap properly closed?</li> <li>• Did you select a programme with too low temperature?</li> <li>• Is the rinse aid dispenser empty?</li> </ul>
<b>Visible lime deposits or white film on the dishes.</b>	<ul style="list-style-type: none"> <li>• Is the salt container empty or is the water softener not correctly adjusted?</li> <li>• Is the rinse aid dispenser adjusted to too low dosage?</li> </ul>
<b>The dishwasher is noisy.</b>	<ul style="list-style-type: none"> <li>• Are the dishes rattling against each other?</li> <li>• Is the spray arm knocking against the dishes?</li> </ul>
<b>Whistling sound when washing.</b>	<ul style="list-style-type: none"> <li>• This is not a fault, try another brand of detergent.</li> </ul>
<b>The dishes are not quite dry and are not shiny.</b>	<ul style="list-style-type: none"> <li>• Is the rinse aid dispenser empty or adjusted to too low dosage?</li> <li>• Have the dishes been left too long inside the dishwasher?</li> </ul>
<b>The door is difficult to close.</b>	<ul style="list-style-type: none"> <li>• Is the dishwasher level?</li> </ul>

If the indicator lamp for the ended programme cycle is flashing, it is possible that you can solve the problem yourself. When the problem is solved, press in the start button and the programme continues. If the problem occurs again, contact your local service centre.

Fault	Check
<p><b>The indicator lamp for the ended programme cycle flashes with approx 3 second pause in between. (Problems with the water supply).</b></p>	<ul style="list-style-type: none"> <li>• Is the water tap turned on?</li> <li>• Is the filter inside the inlet hose blocked?</li> <li>• Is the water inlet hose kinked or nipped?</li> <li>• Are the filters clogged?</li> </ul>
<p><b>The indicator lamp for the ended programme cycle flashes a sequence of two and two. (Problems with water drainage).</b></p>	<ul style="list-style-type: none"> <li>• Is the spigot blocked?</li> <li>• Is the water drain hose kinked or nipped?</li> <li>• Are the filters clogged?</li> </ul>

## Service

**SERVICE FORCE**

### Service and Spare Parts

In the event of your appliance requiring service, or if you wish to purchase spare parts, please contact your local Service Force Centre by telephoning:

**08705 929929**

Your telephone call will be automatically routed to the Service Force Centre covering your post code area.

For the address of your local Service Force Centre and further information about Service Force, please visit the website at [www.serviceforce.co.uk](http://www.serviceforce.co.uk)

For Customer Service in Ireland please contact us at the address below:

Zanussi Electrolux  
 Electrolux Group (Irl) Ltd  
 Long Mile Road  
 Dublin 12  
 Republic of Ireland  
 Tel: + 353 (0)1 4090751  
 Email: [service.eid@electrolux.ie](mailto:service.eid@electrolux.ie)

Before calling out an engineer, please ensure you have read the details under the heading "Something Not Working".

When you contact the Service Force Centre you will need to give the following details:

1. Your name, address and post code
2. Your telephone number
3. Clear and concise details of the fault
4. The model and serial number of the appliance (found on the rating plate affixed to the rear of the dishwasher).
5. The purchase date

**Please note that a valid purchase receipt or guarantee documentation is required for in-guarantee service calls.**

### Customer Care Department

For general enquiries concerning your Zanussi Electrolux appliance or for further information on Zanussi Electrolux products, please contact our Customer Care Department by letter or telephone at the address below or visit our website at [www.zanussi.co.uk](http://www.zanussi.co.uk)

Customer Care Department  
 Zanussi Electrolux  
 55-77 High Street  
 Slough  
 Berkshire  
 SL1 1DZ  
 Tel: 08705 727727 \*

\* call to this number may be recorded for training purposes.



**Never attempt to repair the dishwasher yourself. Repairs carried out by unauthorised or inexperienced persons can cause injury or serious malfunctioning.**

# Guarantee Conditions

## Standard guarantee conditions

We, Zanussi Electrolux, undertake that if within 12 months from the date of the purchase this ZANUSSI ELECTROLUX appliance or any part thereof is proved to be defective by reason only of faulty workmanship or materials, we will, at our option repair or replace the same FREE OF CHARGE for labour, materials or carriage on condition that:

- The appliance has been correctly installed and used only on the electricity supply stated on the rating plate
- The appliance has been used for normal domestic purposes only, and in accordance with the manufacturer's instructions
- The appliance has not been serviced, maintained repaired, taken apart or tampered with by any person not authorised by us
- All service work under this guarantee must be undertaken by a Zanussi Electrolux Service Force Centre
- Any appliance or defective part replaced shall become the Company's property
- This guarantee is in addition to your statutory and other legal rights

Home visits are made between **8.30am** and **5.30pm** Monday to Friday. Visits may be available outside these hours in which case a premium will be charged.

## Exclusions

**This guarantee does not cover:**

- Damage or calls resulting from transportation, improper use or neglect, the replacement of any light bulbs or removable parts of glass or plastic
- Costs incurred for calls to put right an appliance which is improperly installed or calls to appliances outside the United Kingdom
- Appliances found to be in use within a commercial environment, plus those which are the subject to rental agreements
- Products of Zanussi Electrolux manufacture which are not marketed by Zanussi Electrolux

## European Guarantee

If you should move to another country within Europe then your guarantee moves with you to your new home subject to the following qualifications:

- The guarantee starts from the date you first purchased your product
- The guarantee is for the same period and to the same extent for labour and parts as exists in the new country of use for this brand or range of products
- This guarantee relates to you and cannot be transferred to another user
- Your new home is within the European Community (EC) or European Free Trade Area
- The product is installed and used in accordance with our instructions and is only used domestically, i.e. a normal household
- The product is installed taking into account regulations in your new country

Before you move please contact your nearest Customer Care centre, listed below, to give them details of your new home. They will then ensure that the local Service Organisation is aware of your move and able to look after you and your appliances.

France	Senlis	+33 (0)3 44 62 29 99
Germany	Nurnberg	+49 (0)800 234 7378
Italy	Pordenone	+39 (0)0434 39 4700
Sweden	Stockholm	+46 (0)8 672 53 90
UK	Slough	+44 (0)1753 219897
Ireland	Dublin	+353 (0)1 4090751

# Installation instructions

 Any electrical work required to install this appliance, should be carried out by a qualified electrician or competent person.

 Any plumbing work required to install this appliance, should be carried out by a qualified plumber or competent person.

## Technical specifications

<b>Capacity:</b>	6 place settings accordance EN 50242	
<b>Dimensions:</b>	Height	447 mm
	Width	546 mm
	Depth (to the edge of the door)	480 mm
	Depth (to the middle of the door)	507 mm
<b>Weight:</b>	Net	22 kg
<b>Water pressures:</b>	Minimum	80 kPa (0,8 bar)
	Maximum	1000 kPa (10 bar)
<b>Water temperature:</b>	Cold water fill only	
<b>Electrical data:</b>	Power supply	230 V - 50 Hz
	Fuse	10 A
	Heating element	1000 W
	Power rating	1080 W



This appliance complies with the following E.E.C. directives:

- 73/23/EEC, dated 19.02.1973 – low-voltage directive.
- 89/336/EEC, dated 03.05.1989 (incl. amendment)
- 92/31/EEC) – directive on electromagnetic compatibility.

# Unpacking

## Damages

If the dishwasher has been damaged during transport, you should immediately notify the company responsible for delivering it.

If you discover any damage, faults or that anything is missing, you should notify your retailer immediately.



Never leave packaging material in a place where children may play with it. **Risk of suffocation!**

Check that the following accessories are supplied with the dishwasher when you unpack it:

- A funnel for filling salt (1)
- Elbow for discharge hose (2)

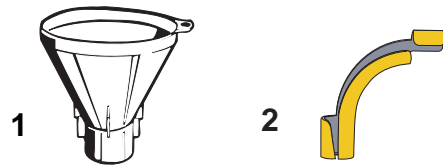

## Use

This dishwasher is designed solely for washing household utensils suitable for washing in a dishwasher. Using it for other purposes may damage it and invalidate the guarantee.

## Positioning

The dishwasher is intended to be installed on a kitchen drainer, worktop or built-in. To function properly, make sure that the appliance is level. Its height can be adjusted with the adjustable feet (5 mm each). See the illustration for built-in measurements.

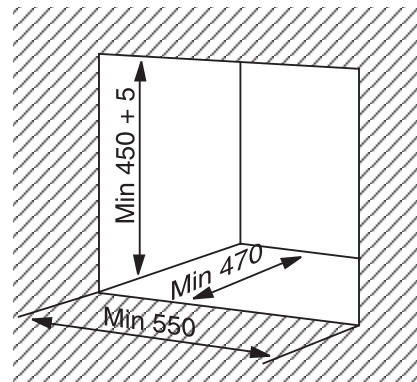
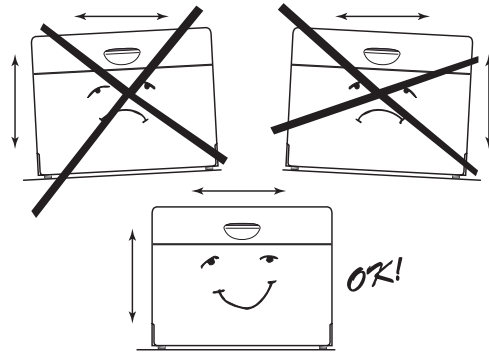



# Installation

## Water inlet

**i** The dishwasher is equipped with safety features which are to prevent the water from going back to the fresh water system. These features are according to current water technical safety regulations.

The dishwasher should be permanently plumbed into a separate cold water supply.

The water pressure must be within the limits given in the technical specifications, as it will not function correctly if pressure is outside these specifications.

Your local Water Authority will advise you on the average mains pressure in your area. Where the water is supplied from a cold water cistern you can work out the pressure yourself by measuring the vertical distance (or 'Head') between the dishwasher's inlet hose and the outlet from the cold water storage cistern; allowing .86 psi for every 2 feet under normal conditions.

We would advise you to have a shut-off valve or stop-cock in the water supply pipe close to the dishwasher and accessible for easy use. This should be turned off when the appliance is not in use. Connect the inlet hose to a tap with a 3/4" pipe thread.

The inlet hose must not be joined onto any form of extension hose. If it is too short, the entire hose must be replaced with a longer high-pressure hose, specially designed for the purpose. The end of the hose, which is connected to the dishwasher can be turned in any direction. Loosen the retaining nut, turn the hose, then retighten the nut.

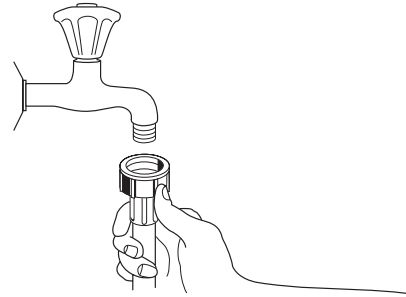

**!** Check that the nut and all other connections are tight before the machine is moved into position.

**!** Use only the inlet hose supplied to the dishwasher. Do not reuse an inlet hose used with a previous machine.

## Water drainage

**i** To protect the dishwasher against water damage it is equipped with a water safety system. In the event of a fault the drain-pump starts automatically and the remaining water inside the dishwasher is pumped out.

**!** The water safety system also works when the dishwasher is switched off. However the dishwasher must be connected electrically.

Place the discharge hose over the sink as illustrated. It must not at any point be higher up than 75 cm over the surface which the dishwasher is standing on. If it runs higher, operation of the dishwasher might be impaired.

It is also important to ensure that the inside diameter of the hose is not less than 13 mm at any point. If the discharge hose is too long, it can easily be cut to the right length.

- !**
1. Cut the hose to a suitable length, using a sharp knife.
  2. Fit the elbow supplied onto the end of the hose.

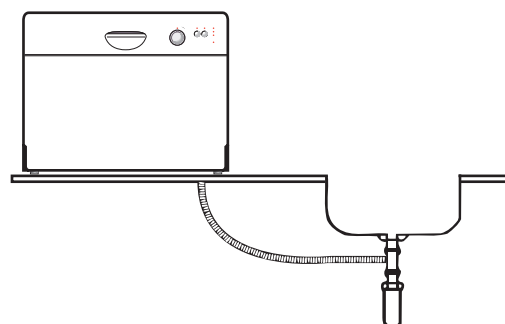
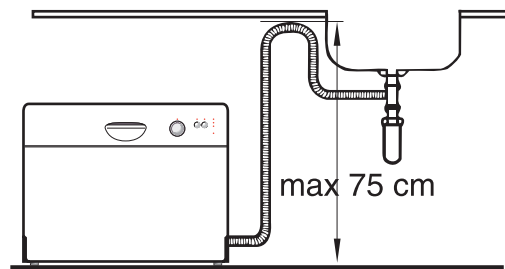
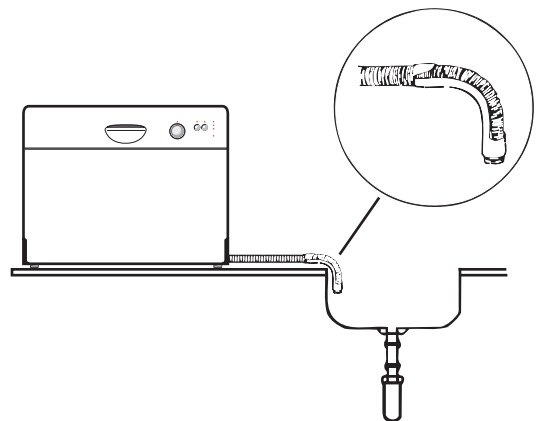

## Power supply

The dishwasher is supplied with a lead and electrical plug for connection to a 230 V, 13 A earthed wall socket. Before any work is carried out on the dishwasher, it must be isolated from the electric mains supply, for example by removing the plug from the wall socket.



**Permanent electrical installation must be carried out by an authorised electrician or competent person.**

**WARNING: THIS APPLIANCE MUST BE EARTHED.**

**The manufacturer declines any liability should this safety measure not be observed.**

**The appliance should not be connected to the electrical supply by means of an extension cable.**

If the plug that is fitted to your appliance is not suitable for your socket outlet, it must be cut off and the appropriate plug fitted.

Remove the fuse from the cut off plug.

**Important:** The plug must still be accessible after the appliance has been installed.

### Important

The wires in the mains lead are coloured in accordance with the following code:

<b>Green and Yellow</b>	- Earth
<b>Blue</b>	- Neutral
<b>Brown</b>	- Live

If you fit your own plug, the colours of the wires in the mains lead of your appliance may not correspond with the markings identifying the terminals in your plug, proceed as follows:

Connect the Green and Yellow (earth) wire to the terminal in the plug which is marked with the letter «E» or the earth symbol  or coloured green and yellow.

Connect the blue (neutral) wire to the terminal in the plug which is marked with the letter «N» or coloured black.

Connect the brown (live) wire to the terminal in the plug which is marked with the letter «L» or coloured red.

The plug moulded onto the lead incorporates a fuse.

For replacement, use a 13 amp BSI362 fuse.

Only ASTA or BSI approved fuses should be used.

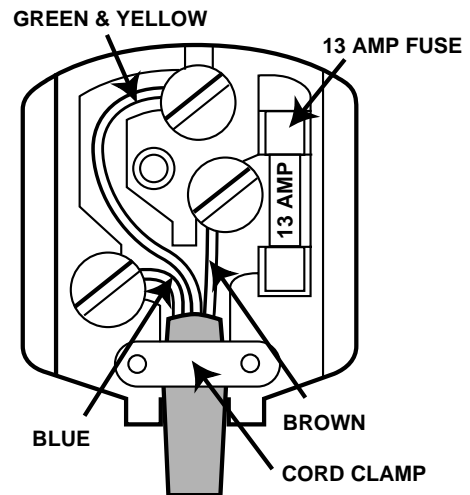

**Warning! A cut off plug inserted into a 13 amp socket is a serious safety (shock) hazard. Ensure that the cut off plug is disposed of safely.**

# Information for test centres

The salt container and rinse aid dispenser shall be filled in accordance with this instruction manual. Before conducting the measurements the dishwasher shall be operated for one or two complete cycles using detergent and a clean load.

Test standard:	EN 50242 and EN 60704
Rated capacity:	6 place settings accordance EN 50242
Loading of basket:	loading according to figure below
Test program:	energy saving 55° C
Detergent (IEC type B):	9 gram in the dispenser + 5 gram in the pre-wash dispenser
Rinse aid (type III):	setting 3
Feed water pressure:	minimum 0,8 bar, maximum 10 bar
Waste water outlet:	install according to figure below

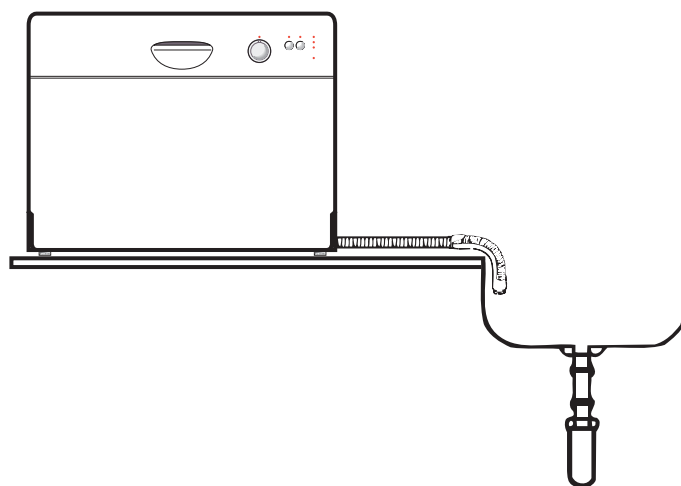
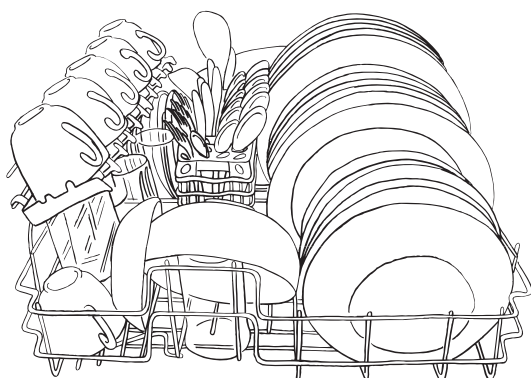

**ZANUSSI**

 **Electrolux**

© Electrolux plc 2005

 **From the Electrolux Group. The world's No. 1 choice.**

*The Electrolux Group is the world's largest producer of powered appliances for kitchen, cleaning and outdoor use. More than 55 million Electrolux Group products (such as refrigerators, cookers, washing machines, vacuum cleaners, chain saws and lawn mowers) are sold each year to a value of approx. USD 14 billion in more than 150 countries around the world.*



Technical changes possible

**AGB** 05-03

## Free Manuals Download Website

<http://myh66.com>

<http://usermanuals.us>

<http://www.somanuals.com>

<http://www.4manuals.cc>

<http://www.manual-lib.com>

<http://www.404manual.com>

<http://www.luxmanual.com>

<http://aubethermostatmanual.com>

Golf course search by state

<http://golfingnear.com>

Email search by domain

<http://emailbydomain.com>

Auto manuals search

<http://auto.somanuals.com>

TV manuals search

<http://tv.somanuals.com>