

User manual

Dishwasher



ZSF 4143

Thank you for selecting our appliance

We wish you lots of enjoyment with your new appliance and we hope that you will consider our brand again when purchasing household appliances.

Please read this user manual carefully and keep it throughout the product life cycle as a reference document. The user manual should be passed on to any future owner of the appliance.

Contents

Safety information _____	3	Use of detergent _____	14
Control panel _____	4	Unloading the dishwasher _____	15
Washing programmes _____	6	Care and cleaning _____	15
First use _____	7	Environmental concerns _____	17
Set the water softener _____	8	What to do if ... _____	17
Filling with dishwasher salt _____	9	Technical data _____	19
Filling with rinse aid _____	10	Consumption values _____	19
Adjusting the dosage of rinse aid _____	11	Hints for test institutes _____	20
Load cutlery and dishes _____	11	Installation _____	21

Subject to change without notice



Safety information

In the interest of your safety and to ensure the correct use, before installing and first using the appliance, read this user manual carefully, including its hints and warnings. To avoid unnecessary mistakes and accidents, it is important to ensure that all people using the appliance are thoroughly familiar with its operation and safety features. Save these instructions and make sure that they remain with the appliance if it is moved or sold, so that everyone using it through its life will be properly informed on appliance use and safety.

Correct use

- This dishwasher is only intended for washing household utensils suitable for machine washing.
- Do not put any solvents in the dishwasher. This could cause an explosion.
- Knives and other items with sharp points must be loaded in the cutlery basket with their points down or placed in a horizontal position in the upper basket.
- Only use products (detergent, salt and rinse aid) suitable for dishwashers.
- Avoid opening the door whilst the appliance is in operation, hot steam may escape.
- Do not take any dishes out of the dishwasher before the end of the dishwashing cycle.
- After use, isolate the appliance from the power supply and turn off the water supply.
- This product should be serviced only by an authorised service engineer, and only genuine spare parts should be used.

- Under no circumstances should you attempt to repair the machine yourself. Repairs carried out by inexperienced persons will cause injury or serious malfunctioning. Contact your local Service Force Centre. Always insist on genuine spare parts.

General safety

- Dishwasher detergents can cause chemical burns to eyes, mouth and throat. Could endanger life! Comply with the safety instructions of the dishwasher detergent manufacturer.
- The water in your dishwasher is not for drinking. Detergent residues may still be present in your machine.
- Ensure that the door of the dishwasher is always closed when it is not being loaded or unloaded. In this way you will avoid anybody tripping over the open door and hurting themselves.
- Do not sit or stand on the open door.

Child safety

- This appliance is designed to be operated by adults. Don't allow children to use the dishwasher unsupervised.
- Keep all packaging well away from children. There is risk of suffocation.
- Keep all detergents in a safe place out of children's reach.
- Keep children well away from the dishwasher when the door is open.

Installation

- Check your dishwasher for any transport damage. Never connect a damaged machine. If your dishwasher is damaged contact your supplier.
- All packaging must be removed before use.
- Any electrical and plumbing work required to install this appliance must be carried out by a qualified and competent person.
- For safety reasons it is dangerous to alter the specifications or attempt to modify this product in any way.
- Never use the dishwasher if the electrical supply cable and water hoses are damaged;

or if the control panel, work top or plinth area are damaged such that the inside of the appliance is freely accessible. Contact your local Service Force centre, in order to avoid hazard.

- All sides of the dishwasher must never be drilled to prevent damage to hydraulic and electric components.

CAUTION!

For electrical and water connection carefully follow the instructions given in specific paragraphs.

Control panel

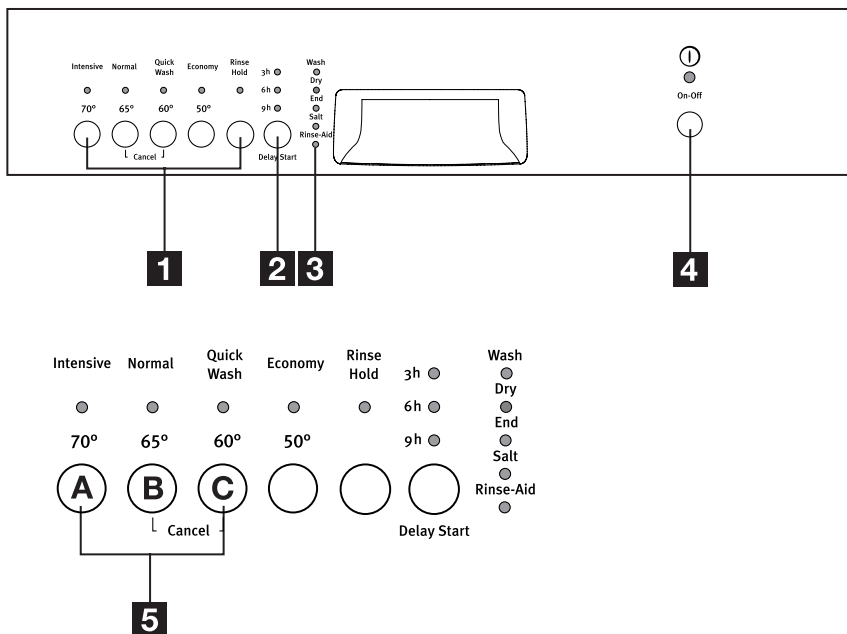

- 1 Programme selection buttons
- 2 Delay start button
- 3 Indicator lights
- 4 On/Off button and On/Off indicator light
- 5 Function buttons

Setting mode

The appliance is in **setting mode** when the On/Off indicator light illuminates and **all** programme lights are off.

Always remember that when performing the following operations:

- selecting a washing programme
 - setting the water softener
 - activating/deactivating the rinse aid dispenser
- the appliance **MUST** be in setting mode.

IMPORTANT!

If a programme light is illuminated, the last performed programme is still set.

In this case the programme has to be cancelled: Simultaneously press and hold the two **Cancel** buttons (B and C) until all the programme lights are off. The programme has been cancelled and the machine is now in setting mode.

Function buttons

In addition to the dishwashing programme selection, the following functions can also be set with the help of these buttons.

- the setting of the water softener,
- the cancelling of a programme in progress.

Programme selection buttons

• **Starting the washing programme:**

1. Press the On/Off button. On/Off light turns on.
2. Press the button corresponding to the required programme, the corresponding light illuminates. The indicator light corresponding to the programme and the phase indicator lights foreseen for that programme will start blinking.
3. After about 3 seconds from the last pressure of a button the programme starts automatically. Once the programme has started the phase indicator lights will turn off except for the phase under way.

IMPORTANT!

Once the programme has started, if you want to change the selection made you must cancel the washing programme in progress.

Delay start button

This option allows the start of the programme to be delayed by 3, 6 or 9 hours. The countdown will decrease with steps of 3 hours. Before selecting the washing programme, press the On/Off button and then press the Delay start button until the light corresponding to 3h, 6h or 9h illuminates.

Press the button corresponding to the required washing programme, the countdown will start automatically after about 3 seconds.

Once the countdown has elapsed the washing programme will start automatically. The **delay start** light will turn off.

- **Cancel the delay start in progress:**

Press the **Delay start** button until the lights corresponding to 3h, 6h or 9h are off. The selected washing programme will start automatically.

Indicator lights

Wash	Illuminates when the washing and rinsing phases are running.
Dry	Illuminates when the drying phase is running.
End of programme	Illuminates when the washing programme has ended. It also has added functions of visual signalling as: <ul style="list-style-type: none">• the setting of the water softener,• intervention of an alarm due to the malfunction of the machine.
Salt refilling 1)	Illuminates when special salt needs to be filled. It can remain illuminated several hours after the salt has been filled.
Rinse-Aid 1)	Illuminates when rinse aid needs to be filled.

1) The salt and rinse aid indicator lights are never illuminated while a washing programme is running even if filling with salt and rinse aid is necessary.

Washing programmes

Programme	Use	Cycle description
Intensive 70°	Heavy soil. Crocery, cutlery, pots and pans	Prewash Main wash 2 intermediate rinses Final rinse Dry
Normal 65°	Normal soil. Crocery and cutlery	Prewash Main wash 1 intermediate rinse Final rinse Dry
Quick Wash 60°¹⁾	Light soil. Crocery and cutlery	Main wash Final rinse
Economy 50°²⁾	Normal soil. Crocery cutlery	Prewash Main wash 1 intermediate rinse Final rinse Dry
Rinse Hold	Any. Partial load (to be completed later in the day).	1 cold rinse (to avoid food scraps from sticking together). This programme does not require the use of detergent.

1) Ideal for washing a partially loaded dishwasher. This is perfect daily programme, made to meet the needs of a family of 4 persons who only wish to load breakfast and dinner crocery and cutlery.

2) Test programme for test institutes.

First use

Before using your dishwasher for the first time:

- Ensure that the electrical and water connections comply with the installation instructions
- Remove all packaging from inside the appliance
- Set the water softener
- Pour 1 litre of water inside the salt container and then fill with dishwasher salt
- Fill the rinse aid dispenser

When using tablets that integrate rinse aid and detergent:

there is no need to fill up with rinse aid

- set the water softener
- add special (dishwasher) salt

When using tablets that integrate rinse aid, detergent, salt function and other additives: there is no need to fill up with special salt or rinse aid.

Check whether these detergents are suitable for your water hardness. Follow the manufacturers instructions.

- Set the water hardness to level 1.

IMPORTANT!

If the drying results are not satisfactory we recommend that you:

1. Fill up the rinse aid dispenser with rinse aid.
2. Set the rinse aid dosage to position 2.

If you decide in future to use separated detergents, we advise that you:

- Fill up the salt and rinse aid container.
- Adjust the water hardness setting to the highest level and perform 1 normal washing programme without loading any dishes.
- Adjust the water hardness setting according to the hardness of the water in your area.
- Adjust the rinse aid dosage

Set the water softener

The dishwasher is equipped with a water softener designed to remove minerals and salts from the water supply, which would have a detrimental or adverse effect on the operation of the appliance.

The higher the content of these minerals and salts, the harder your water is.

Water hardness is measured in equivalent scales, Clarke degrees, French degrees (°TH)

and mmol/l (millimol per litre - international unit for the hardness of water).

The softener should be adjusted according to the hardness of the water in your area. Your local Water Authority can advise you on the hardness of the water in your area.

Water hardness			Adjusting the water hardness setting		Use of salt
Clarke	°TH	mmol/l	manually	electronically	
64 - 88	91 - 125	9,0- 12,5	2	level 10	yes
53 - 63	76 - 90	7,6 - 8,9	2	level 9	yes
46 - 52	65 - 75	6,5 - 7,5	2	level 8	yes
36 - 45	51 - 64	5,1 - 6,4	2	level 7	yes
28 - 35	40 - 50	4,0 - 5,0	2	level 6	yes
23 - 27	33 - 39	3,3 - 3,9	2	level 5	yes
18 - 22	26 - 32	2,6 - 3,2	1	level 4	yes
13 - 17	19 - 25	1,9 - 2,5	1	level 3	yes
5 - 12	7 - 18	0,7 - 1,8	1	level 2	yes
< 5	< 7	< 0,7	1	level 1	no

The water softener must be set in both ways: manually, using the water hardness dial and electronically.

Setting the water softener manually (see table)

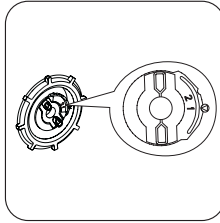
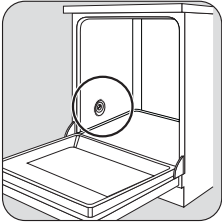

Set switch to position 1 or 2

The water softener is factory set at position 2.

Setting the water softener electronically (see table)

IMPORTANT!

The water softener is factory set at position 5.

1. The dishwasher must be switched off. Switch on the dishwasher by pressing the On/Off button.
2. Press and hold simultaneously function buttons **B** and **C** until the lights of function buttons **A**, **B** and **C** start flashing.
3. Release the buttons and then press function button **A**; the lights of function buttons **B** and **C** turn off while function button **A** goes on flashing. At the same time **End of programme** light starts to flash.

The number of flashes of the **End of programme** light corresponds to the current level.

4. The **End of programme** light might flash 5 times, for example. The flashing is repeated every 5 seconds.
5. To change the level, press function button **A**. Each time the button is pressed the level increases. (Level 1 follows level 10).
6. The **End of programme** light indicates the new setting. (For the selection of the new level see the chart).
7. To memorise the operation, switch off the dishwasher by pressing the On/Off button.

Filling with dishwasher salt

CAUTION!

Use only special salt suitable for dishwashers.

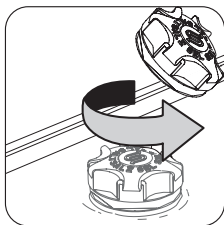
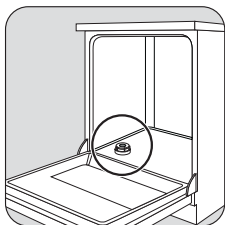

Unscrew the cap.



Only before filling with salt for the first time, fill the salt container with water.

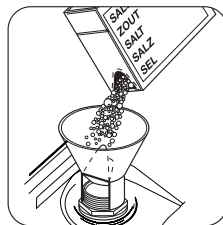

Using the funnel provided, pour in the salt until the container is filled with salt.

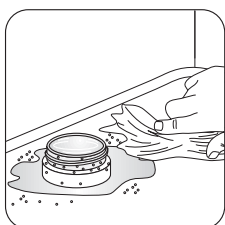

Remove any trace of salt.

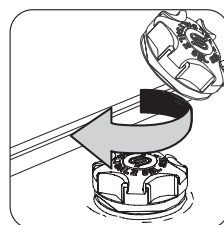

Replace the cap tightly turning it clockwise until it stops with a click.

IMPORTANT!

Immediately start a complete programme.

IMPORTANT!

Water will overflow from the container as salt is added.

IMPORTANT!

Top up the special salt when the light on the control panel illuminates.

Filling with rinse aid

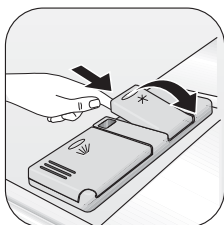
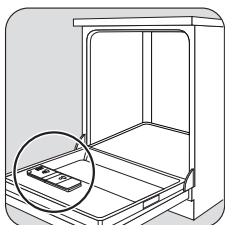

Open the lid.

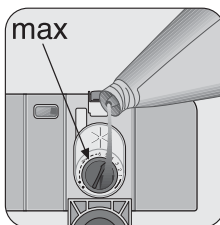

Fill up with rinse aid. The maximum level for filling is indicated by "max"



Clean up any rinse aid which overflows. Close the lid and press until it locks.

! CAUTION!

Never fill the rinse aid dispenser with any other substances (e.g. dishwasher cleaning agent, liquid detergent). This would damage the appliance.

IMPORTANT!

Top up the rinse aid when the light on the control panel illuminates.

Adjusting the dosage of rinse aid

Increase the dose if there are drops of water or lime spots on the dishes after washing.

Reduce the dose if there are whitish streaks on the dishes or a bluish film on glassware or knife blades.

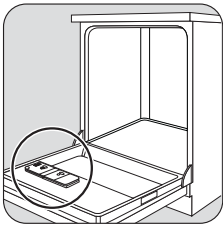

Open the lid.

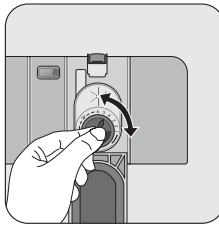

Set the dosage level. (The dose is factory set in position 4).



Close the lid and press until it locks.

Load cutlery and dishes

Sponges, household cloths and any object that can absorb water may not be washed in the dishwasher.

- Before loading the dishes, you should:
 - Remove all left over food and debris.
 - Soften remnants of burnt food in pans
- When loading the dishes and cutlery, please note:
 - Dishes and cutlery must not impede the rotation of the spray arms.
 - Load hollow items such as cups, glasses, pans, etc. with the opening downwards so that water cannot collect in the container or a deep base.
- Dishes and items of cutlery must not lie inside one another, or cover each other.
- To avoid damage to glasses, they must not touch.
- Lay small objects in the cutlery basket.
- Plastic items and pans with non stick coatings have a tendency to retain water drops; these items will not dry as well as porcelain and steel items.
- Light items (plastic bowls etc.) must be loaded in the upper basket and arranged so they do not move.

For washing in the dishwasher the following cutlery and dishes

are not suitable:

- Cutlery with wooden, horn, china or mother-of-pearls handles.
- Plastic items that are not heat resistant.
- Older cutlery with glued parts that are not temperature resistant.
- Bonded cutlery items or dishes.
- Pewter or copper items.
- Lead crystal glass.
- Steel items prone to rusting.
- Wooden platters.
- Items made from synthetic fibres.

are of limited suitability:

- Only wash stoneware in the dishwasher if it is specially marked as being dishwasher-safe by the manufacturer.
- Glazed patterns may fade if machine washed frequently.
- Silver and aluminium parts have a tendency to discolour during washing; Residues, e.g. egg white, egg yolk and mustard often cause discolouring and staining on silver. Therefore always clean left-overs from silver immediately, if it is not to be washed straight after use.

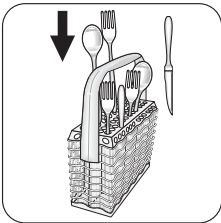

Load cutlery. For best results we recommend you to use the cutlery grid provided (if the size and dimensions of the cutlery allow it)

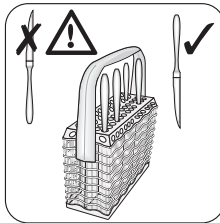

Place knives and other items of cutlery with sharp points or edges with their handles facing upwards. Risk of injury!

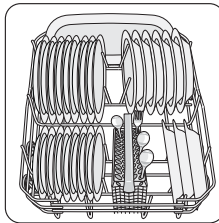

Load the lower basket. Arrange serving dishes and large lids around the edge of the basket.

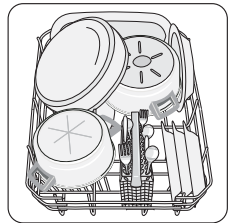

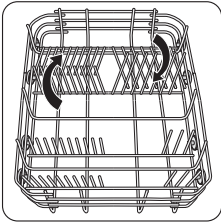

The two rows of prongs on the lower basket can be easily lowered to allow you to load pots, pans and bowls.

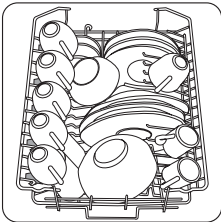

Load upper basket. Light items (plastic bowls etc.) must be loaded in the upper basket and arranged so they do not move.

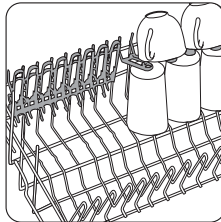

For taller items, the cup racks can be folded upwards.

Adjusting the height of the upper basket

If washing very large plates you can load them in the lower basket after moving the upper basket to the higher position.

	Maximum height of the dishes in :	
	upper basket	lower basket
With upper basket raised	20 cm	31 cm
With upper basket lowered	24 cm	27 cm

To move to the higher position proceed as follows:

1. Pull out the basket until it stops.
2. Carefully lift both sides upwards until the mechanism is engaged and the basket is stable.

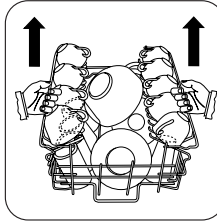

To lower the basket to the original position proceed as follows:

1. Pull out the basket until it stops.
2. Carefully lift both sides upwards and then allow the mechanism to drop back down slowly, keeping hold of it.

IMPORTANT!

Never lift or lower the basket on one side only

IMPORTANT!

When the basket is in the higher position you will not be able to use the cup racks.

Use of detergent

IMPORTANT!

Only use detergents suitable for dishwashers.

Observe the manufacturer's dosing and storage recommendations.

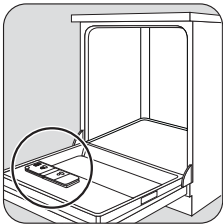

Open the lid.

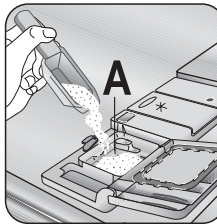

Fill in the detergent in compartment A.

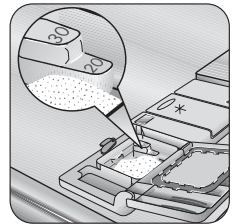

Observe the dosing levels.

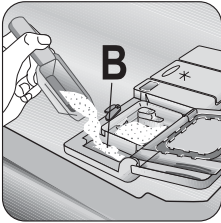

For programmes with pre-wash add an additional detergent dose in compartment **B**.

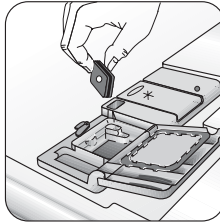

When using detergent tablets: place detergent tablets in compartment **A**.



Close the lid.

Detergent tablets

Detergent tablets from different manufacturers dissolve at different rates. For this reason, some detergent tablets do not attain their full

cleaning power during short washing programmes. Therefore, please use long washing programmes when using detergent tablets, to ensure the complete removal of detergent residuals.

Unloading the dishwasher

- Hot dishes are sensitive to knocks. The dishes should therefore be allowed to cool down before removing from the appliance.
- Empty the lower basket first and then the upper one; this will avoid water dripping from the upper basket onto the dishes in the lower one.

- Water may appear on the sides and the door of the dishwasher as the stainless steel will eventually become cooler than the dishes.

CAUTION!

When the washing programme has finished, it is recommended that the dishwasher is unplugged and the water tap turned off.

Care and cleaning

Cleaning the filters

IMPORTANT!

NEVER use the dishwasher without filters. Incorrect repositioning and fitting of the filters will produce poor washing results.

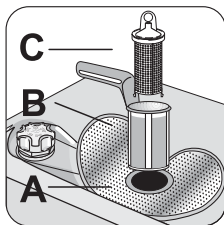
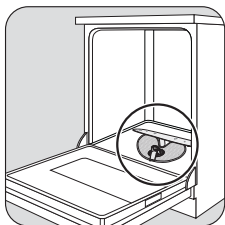

Clean filters **A**, **B** and **C** thoroughly under running water.

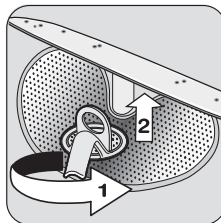

Turn the handle about 1/4 turn anticlockwise and remove filters **B** and **C**.

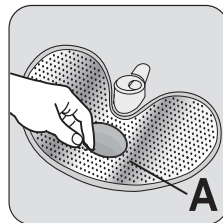

Remove filter **A** from the base of the washing compartment.

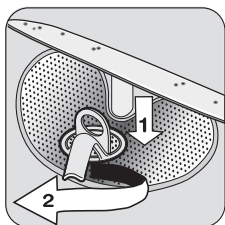

Replace the filters and lock by turning the handle clockwise to the stop.

Cleaning the spray arms

NEVER try to remove the spray arms.

If residues of soil have clogged the holes in the spray arms, remove them with a cocktail stick.

External cleaning

Clean the external surfaces of the machine and control panel with a damp soft cloth. If necessary use only neutral detergents. Never use abrasive products, scouring pads or solvent (acetone, trichloroethylene etc....).

Internal cleaning

Ensure that the seals around the door, the detergent and rinse aid dispensers are cleaned regularly with a damp cloth.

We recommend every 3 months to run the wash programme for heavy soiled dishes using detergent but without dishes.

Prolonged periods of non-operation

If you are not using the machine for any prolonged period of time you are advised to:

1. Unplug the appliance and then turn off the water.

2. Leave the door ajar to prevent the formation of any unpleasant smells.
3. Leave the inside of the machine clean.

Frost precautions

Avoid placing the machine in a location where the temperature is below 0°C. If this is unavoidable, empty the machine, close the appliance door, disconnect the water inlet pipe and empty it.

Moving the machine

If you have to move the machine (moving house etc....):

1. Unplug it.
2. Turn the water tap off.
3. Remove the water inlet and discharge hoses.
4. Pull the machine out together with the hoses.

Avoid over tilting the machine during transportation.

Environmental concerns

Packaging material

The packaging materials are environmentally friendly and can be recycled. The plastic components are identified by markings, e.g. >PE<, >PS<, etc. Please dispose of the packaging materials in the appropriate container at the community waste disposal facilities.

CAUTION!

When a unit is no longer being used:

- Pull the plug out of the socket.
- Cut off the cable and plug and dispose of them.
- Dispose of the door catch. This prevents children from trapping themselves inside and endangering their lives.

The symbol  on the product or on its packaging indicates that this product may not be treated as household waste. Instead it should be taken to the appropriate collection point for the recycling of electrical and electronic equipment. By ensuring this product is disposed of correctly, you will help prevent potential negative consequences for the environment and human health, which could otherwise be caused by inappropriate waste handling of this product. For more detailed information about recycling of this product, please contact your local council, your household waste disposal service or the shop where you purchased the product.

What to do if ...

The dishwasher will not start or stops during operation. Certain problems are due to the lack of simple maintenance or oversights, which can

be solved with the help of the indications described in the chart, without calling out an engineer.

Switch off the dishwasher, open the door and carry out the following suggested corrective actions.

Fault code and malfunction	Possible cause and solution
<p>The dishwasher does not fill with water.</p> <ul style="list-style-type: none"> • continuous flashing of the light of the running programme • 1 flash of the "End of programme" light 	<ul style="list-style-type: none"> • The water tap is blocked or furred with limescale. Clean the water tap. • The water tap is turned off. Turn the water tap on. • The filter (where present) in the threaded hose fitting at the water inlet valve is blocked. Clean the filter in the threaded hose fitting. • The water inlet hose has not been correctly laid or it is bent or squashed. Check the water inlet hose connection.
<p>The dishwasher will not drain.</p> <ul style="list-style-type: none"> • continuous flashing of the light of the running programme • 2 flashes of the "End of programme" light 	<ul style="list-style-type: none"> • The sink spigot is blocked. Clean out the sink spigot. • The water drain hose has not been correctly laid or it is bent or squashed. Check the water drain hose connection.
<ul style="list-style-type: none"> • continuous flashing of the light of the running programme • 3 flashes of the end of programme indicator light • The programme does not start. 	<ul style="list-style-type: none"> • Anti-flood device is activated. Close the water tap and contact your local Service Force Centre. • The dishwasher door has not been properly closed. Close the door. • The main plug is not plugged in. Insert the mains plug. • The fuse has blown in the household fuse box. Replace the fuse.

Once these checks have been carried out; close the dishwasher's door and switch on the appliance. Press the button of the programme that was running before the intervention of the alarm. The programme will continue from the point at which it was interrupted. If the malfunction or fault code reappears contact the Service Force Centre.

For other fault codes not described in the above chart, please contact your Service Force Centre.

Contact your local Service Force Centre, quoting the model (Mod.), product number (PNC) and serial number (S.N.).

This information can be found on the rating plate located on the side of the dishwasher door.

So that you always have these numbers at hand, we recommend you to make a note of them here:

Mod. :
 PNC :
 S.N. :

The wash results are not satisfactory

The dishes are not clean	<ul style="list-style-type: none"> • The wrong washing programme has been selected. • The dishes are arranged in such a way as to stop water reaching all parts of the surface. The baskets must not be overloaded. • The spray arms do not rotate freely due to incorrect arrangement of the load. • The filters in the base of the washing compartment are dirty or incorrectly positioned. • Too little or no detergent has been used. • Where there are limescales deposits on the dishes; the salt container is empty or the incorrect level of the water softener has been set. • The drain hose connection is not correct. • The salt container cap is not properly closed.
The dishes are wet and dull	<ul style="list-style-type: none"> • Rinse aid was not used. • The rinse aid dispenser is empty.
There are streaks, milky spots or a bluish coating on glasses and dishes	<ul style="list-style-type: none"> • Decrease rinse aid dosing.
Water drops have dried onto glasses and dishes	<ul style="list-style-type: none"> • Increase rinse aid dosing. • The detergent may be the cause. Contact the detergent manufacturer's consumer care line.

If after all these checks, the problem persists, contact your local Service Force Centre.

Technical data

Dimensions	Width x Height x Depth (cm)	45 x 85 x 63
Electrical connection Voltage - Overall power - Fuse	Information on the electrical connection is given on the rating plate on the inner edge of the dishwasher's door.	
Water supply pressure	Minimum - Maximum	0,05 - 0,8 (MPa) 0,5 - 8 (bar)
Capacity	place settings	9

Consumption values

The consumption values are intended as a guide and depends on the pressure and the temperature of the water and also by the var-

iations of the power supply and the amount of dishes.

Programme	Consumption values		
	Programme duration (in minutes)	Energy consumption (in kWh)	Water (litres)
Intensive 70°	80 - 90	1,5 - 1,7	18 - 20
Normal 65°	90 - 100	1,1- 1,2	15- 16
Quick Wash 60°	30	0,8	8
Economy 50° ¹⁾	160 - 170	0,8 - 0,9	12 - 13
Rinse Hold	12	0,1	3,5

1) Test programme for Test Institutes

Hints for test institutes

Testing in accordance with **EN 60704** must be carried out with appliance fully loaded and using the test programme (see "Consumption values").

Test in accordance with **EN 50242** must be carried out when the salt container and rinse

aid dispenser have been filled with salt and rinse aid respectively and using the test programme (see "Consumption values").

Full load: 9 standard place settings	
Amount of detergent required	5 g + 20 g (Type B)
Rinse aid setting	position 4 (Type III)

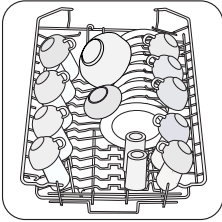

Upper basket without smaller bowl and salad-bowl

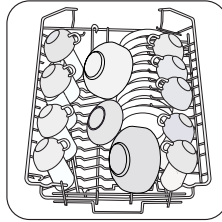

Upper basket with smaller bowl and salad-bowl

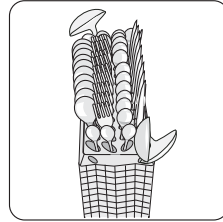

Cutlery basket

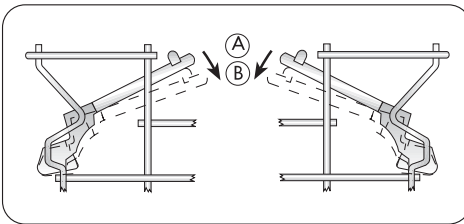

cup racks: position A

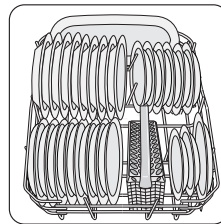

Lower basket

Installation

! WARNING!

Any electrical and/or plumbing work required to install this appliance should be carried out by a qualified electrician and/or plumber or competent person.

Water connection

! WARNING!

The dishwasher must not be connected to open water appliances or instantaneous water heat-

ers. This dishwasher must be fed with cold water.

! WARNING!

Only use, for connection to the water mains, new hose-set; old hose-set must not be reused.

! CAUTION!

If the machine is connected to new pipes or pipes which have not been used for a long time, you should run the water for a few minutes before connecting the inlet hose.

Inlet hose

Connect the inlet hose to a water tap with an external thread of 3/4".

The inlet hose can be turned either to the left or the right to suit the installation by means of the locknut. The locknut must be correctly fitted to avoid water leaks.

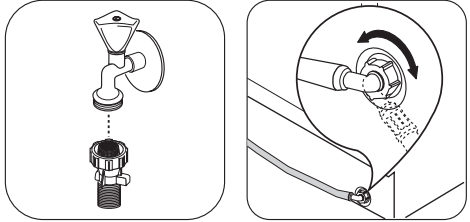

Drain hose

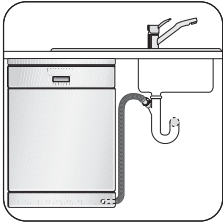

Connect drain hose to the sink.

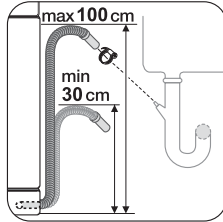

Required height: 30 to 100 cm above bottom of the dishwasher.

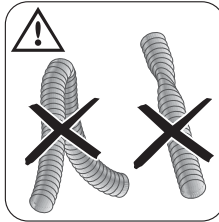

Ensure that the hoses are not kinked, crushed or entangled.

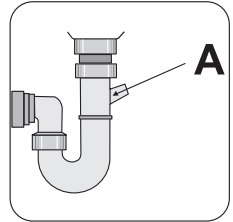

When connecting the drain hose to an under sink trap spigot, **the entire plastic membrane (A) must be removed**. Failure to remove all the membrane will result in food particles building up over time eventually blocking the dishwasher drain hose spigot.

If you use a drain hose extension the total length should not be longer than 4 metres. Likewise the internal diameter of the couplings used for connections to the waste outlet must be no smaller than the diameter of the hose provided.

Electrical connection

⚠ CAUTION!

Safety standards require the appliance to be earthed.

Prior to using the appliance for the first time, ensure that the rated voltage and type of supply on the rating plate match that of the supply where the appliance is to be installed.

The fuse rating is also to be found on the rating plate.

Always plug the mains plug into a correctly installed shockproof socket. Multi-way plugs, connectors and extension cables must not be used.

This could constitute a fire hazard through overheating.

If necessary, have the domestic wiring system socket replaced. In case that the electrical ca-

ble has to be replaced, contact your local Service Force centre.

The plug must be accessible after the appliance has been installed.

Never unplug the appliance by pulling on the cable. Always pull the plug.

The manufacturer accepts no liability for failure to observe the above safety precautions.

Fitting under a counter

By removing the dishwasher's worktop, you can install it under a close fitting sink unit or a pre-existing top.

Be sure that once the appliance has been installed, it is easily accessible for the service engineer in the event that a repair is required.

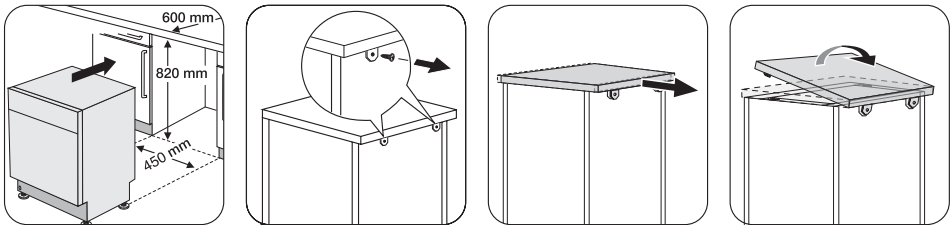

Levelling

Good levelling is essential for correct closure and sealing of the door.

When the appliance is correctly levelled, the door will not catch on either side of the cabinet.

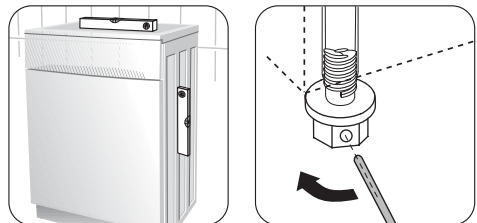

www.electrolux.com

To buy accessories, consumables and spare parts at our online shop please visit:
www.zanussi-electrolux.co.uk

Free Manuals Download Website

<http://myh66.com>

<http://usermanuals.us>

<http://www.somanuals.com>

<http://www.4manuals.cc>

<http://www.manual-lib.com>

<http://www.404manual.com>

<http://www.luxmanual.com>

<http://aubethermostatmanual.com>

Golf course search by state

<http://golfingnear.com>

Email search by domain

<http://emailbydomain.com>

Auto manuals search

<http://auto.somanuals.com>

TV manuals search

<http://tv.somanuals.com>