

INSTRUCTION BOOKLET

ZANUSSI

**DISHWASHER
ZT 617**

CONTENTS

Warnings	page	3
Installation	page	4
Positioning, levelling, water supply connections, water outlet connection	page	4
The electrical connections	page	5
Use	page	6
Control panel	page	6
The water softener, filling with salt	page	8
Use of rinse aid, use of detergent	page	9
Loading the machine, use of the lower basket, use of the upper basket	page	10
Adjusting the height of the upper basket	page	11
Helpful hints	page	11
Washing programmes	page	12
Operating sequence	page	13
Maintenance and cleaning	page	14
Cleaning the central filters, cleaning the large filter, internal and external cleaning	page	14
Prolonged periods of Non-Operation	page	15
Servicing	page	16
Building-in	page	18
Peace of mind for twentyfour months	page	20

TECHNICAL SPECIFICATIONS

DIMENSIONS	Width	cm 59,6
	Height	cm 81,8 - 87,8
	Max depth	cm 55,5
	Max depth with door open	cm 115
ELECTRICAL CONNECTION	Voltage	220-240 V/50Hz
POWER OF HEATING ELEMENT		2570 W
OVERALL POWER		2720 W
WATER SUPPLY PRESSURE	minimum	7 psi - 49 KN/cm ²
	maximum	110 psi - 758 KN/cm ²
CAPACITY (STANDARD IEC PLACE SETTINGS)		12
CONSUMPTION:	Water	19 lt
	Electricity	1.4 kW/h

CE This appliance complies with the following E.E.C. Directives:
- 73/23 of 19.2.73 (Low Voltage Directive) and subsequent modifications;
- 89/336 of 3.5.89 (Electromagnetic Compatibility Directive) and subsequent modifications.

WARNINGS

It is most important that this instruction book should be retained with the appliance for future reference. Should the appliance be sold or transferred to another owner, or should you move house and leave the appliance, always ensure that the book is left with the appliance in order that the new owner can get to know the functioning of the appliance and the relevant warnings.

These warnings are provided in the interest of safety. You MUST read them carefully before installing or using the appliance.

Installation

- This appliance is heavy. Care should be taken when moving it.
- It is dangerous to alter the specifications or attempt to modify this product in any way.
- Care must be taken to ensure that the appliance does not stand on the electrical supply cable.
- Any electrical work required to install this appliance should be carried out by a qualified electrician or competent person.
- Any plumbing work required to install this appliances should be carried out by a qualified plumber or competent person.
- Built-in dishwashers only: The appliance must be secured to the underside of the worktop using the brackets provided. Failure to do this could result in an unstable appliance which may cause damage or injury.

Child Safety

- This appliance is designed to be operated by adults. Children should not be allowed to tamper with the controls or play with the product.

During Use

- Zanussi dishwashers are designed to be used for washing normal household utensils. Items that are contaminated by petrol, paint, steel or iron debris, corrosive, acidic or alkaline chemicals are not to be washed in a dishwasher.
- Under no circumstances should you open the door whilst the appliance is in operation. Always turn off the appliance before opening the door.
- When finishing loading or unloading close the door, as an open door can be a hazard.
- Unplug the appliance and turn off the water after use.
- If your house is fitted with a water softening unit or if you live in a soft water area, it is not necessary to add salt to the water softening unit in the dishwasher.

- Do not put in your dishwasher; cutlery with wooden or horn handles or glued parts, bronze cutlery, saucepans with wooden handles, unless they are sold as dishwasher proof, aluminium ware, crystal ware, leaded glass, plastic articles unless sold as dishwasher proof, antique china or fine decorated china unless sold as dishwasher proof. Always check with the manufacturer of the item if in any doubt.
- A chemical reaction can occur between silver cutlery and stainless steel cutlery. As a precaution, do not wash together.
- Care should be taken when cleaning the bottom door seal and hinge area as any exposed metal edges may cut if care is not taken.
- This product should be serviced by an authorised Zanussi engineer, and only genuine Zanussi spare parts should be used.
- Under no circumstances should you attempt to repair the machine yourself. Repairs carried out by inexperienced persons may cause injury or serious malfunctioning. Contact your local Zanussi Service Centre. Always insist on genuine Zanussi Spare Parts.

Conservation

In the interests of the Environment:

When disposing of your old appliance:

- Help to keep your country tidy - use authorised disposal sites for your old appliances.
- The materials used on this appliance marked with the symbol  are recyclable.
- Check with your local Council or Environmental Health Office to see if there are facilities in your area for re-cycling this appliance.
- If you are discarding an old appliance that has a lock or catch on the door, you must ensure that it is made unusable to prevent young children being trapped inside.

INSTALLATION

Remove all packaging before positioning the machine.

Positioning

If possible, position the machine next to a water tap and a drain.

The dishwasher features fill and drain hoses which can be turned either to the left or the right to suit the installation.

Levelling

Good levelling is essential for correct closure and sealing of the door.

When the appliance is correctly levelled, the door will not catch on the spacers on either side of the cabinet.

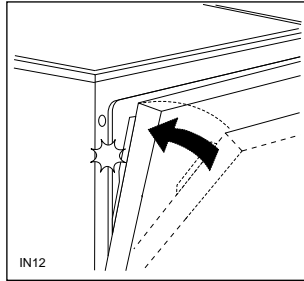
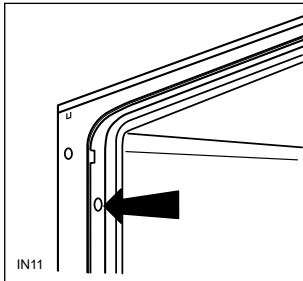

If the door does not close correctly, loosen or tighten the adjustable support feet, until the machine is perfectly level.

Water Supply Connections

This dishwasher must be permanently plumbed into a cold water supply.

The water pressure must be within the limits given in the technical specifications, as it will not function correctly if pressure is outside these specifications.

Your local Water Authority will advise you on the average mains pressure in your area.

Where the water is supplied via a cold water storage cistern, you can work out the pressure yourself by measuring the vertical distance (or «head») between the machine's inlet hose and the outlet from the cold water storage cistern, allowing roughly 1 psi for every 2 feet.

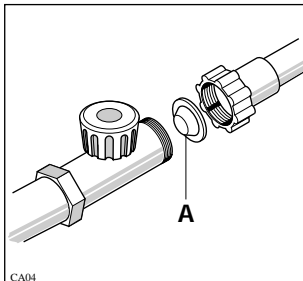

For making the connection itself, the coupling nut fitted to the machine's supply hose is designed to screw onto either a 3/4 inch gas thread spout, or to a purpose made quick-coupling tap such as the Press Block.

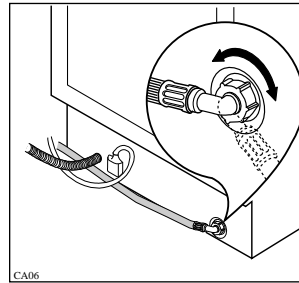

To make this easier, the hose itself may be turned to the left or the right. In either case, be sure to incorporate the strainer (A) supplied with the machine into the joint. See picture.

Caution: the retaining ring must be correctly fitted to avoid water leaks.

Avoid bends or kinks in the hose which could prevent or slow down the flow of water.

If the machine is connected to new pipes or pipes which have not been used for a long time, you are advised to run the water for a few minutes before connecting the inlet hose. This will prevent deposits of sand or rust clogging the inlet hose filter.

Water Outlet Connection

The end of the drain hose can be connected as follows:

to the sink outlet siphon, securing it if necessary with a clip;

to a wall outlet provided with vent-hole, minimum internal diameter 4 cm;

The waste connection must be at a height of between 30 cm (minimum) and 100 cm (maximum) from the floor.

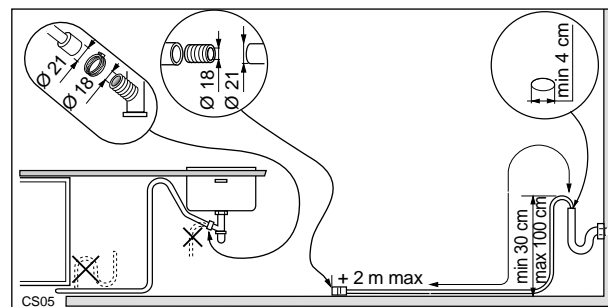

It makes no difference which way the drain hose faces, either to the right or left of the dishwasher.

Avoid bending or kinking the hose as this could prevent or slow down the discharge of water.

If you use a drain hose extension it must be no longer than 2 metres and its internal diameter must be no smaller than the diameter of the hose provided.

Likewise the internal diameter of the couplings used for connection to the waste outlet must be no smaller than the diameter of the drain hose.

Note: The sink plug must not be in place when the machine is draining as this could cause the water to siphon back into the machine.

The electrical connections

WARNING: THIS APPLIANCE MUST BE EARTHED.

The manufacturer declines any liability should this safety measure not be observed.

If the plug that is fitted to your appliance is not suitable for your socket outlet, it must be cut off and the appropriate plug fitted.

Remove the fuse from the cut off plug.
The cut off plug should then be disposed of to prevent the hazard of shocks in case it should be plugged into a 13 amp socket in another part of your home.

Important

The wires in the mains lead are coloured in accordance with the following code:

Green and Yellow	- Earth
Blue	- Neutral
Brown	- Live

If you fit your own plug, the colours of the wires in the mains lead of your appliance may not correspond with the markings identifying the terminals in your plug, proceed as follows:

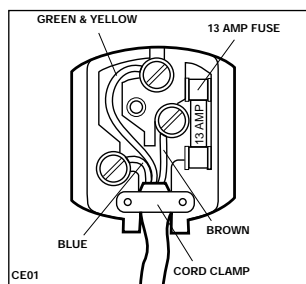

Connect the Green and Yellow (earth) wire to the terminal in the plug which is marked with the letter «E» or the earth symbol \oplus or coloured green and yellow.
Connect the Blue (neutral) wire to the terminal in the plug which is marked with the letter «N» or coloured black.

Connect the Brown (live) wire to the terminal in the plug which is marked with the letter «L» or coloured red.

The plug moulded onto the lead incorporates a fuse.
For replacement, use a 13amp BSI362 fuse.
Only ASTA or BSI approved fuses should be used.

The plug must not be used if the fuse cover/carrier is lost. The cover/carrier is indicated by the coloured insert at the base of the plug.

A replacement cover/carrier must be obtained from your local Zanussi Service Force Centre whose address is listed in the Customer Care Booklet which accompanies your instruction manual.

CE This appliance complies with the following E.E.C. Directives:

- 73/23 of 19.2.73 (Low Voltage Directive) and subsequent modifications;

- 89/336 of 3.5.89 (Electromagnetic Compatibility Directive) and subsequent modifications.

Please ensure that when the appliance is installed it is easily accessible for the engineer in the event of a breakdown.

Control panel

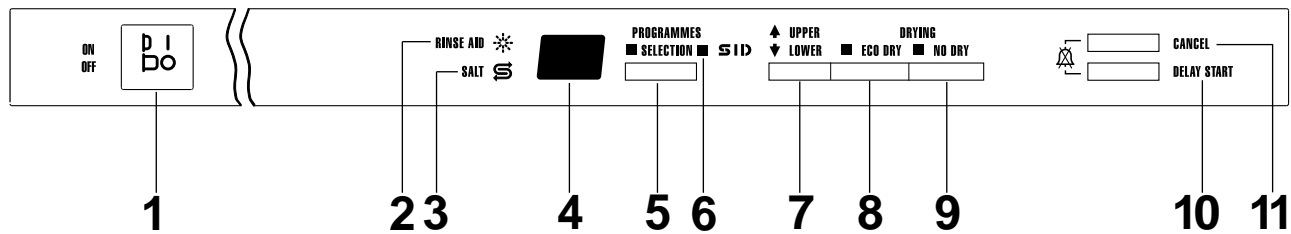

THE CONTROLS

The controls are located on top of the door. When selecting a programme, the door needs to be partially opened.

Audible signals indicate which operations the dishwasher is performing.

Short «instruction accepted» signal

When any of the buttons are pressed: a short audible signal informs you that the machine has accepted the instruction given; if no signal is heard when a button is pressed, this means that a programme is already running or that the programme selected does not include this function.

Long «programme run» signal

A continuous audible signal lasting about one second, heard only when you close the dishwasher door, informs you that the wash programme is starting.

Intermittent «end of programme» signal

An intermittent audible signal, lasting in total five seconds, informs you that the wash programme has ended.

To deactivate these audible signals, press both the CANCEL and DELAY START buttons together for about 3 seconds, until three short signals are heard.

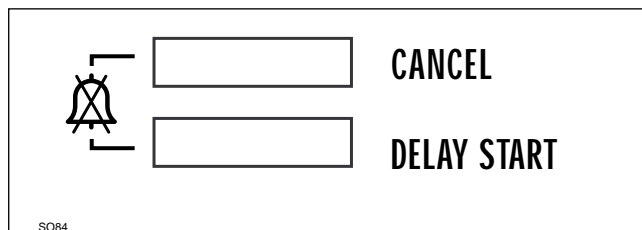

To reactivate the audible signals, press both buttons together again for about 3 seconds, until the «short instruction accepted» signal is heard.

1. ON/OFF button

ON

Press this button to preset the dishwasher to accept settings (selection of wash programmes, drying options, delayed start, etc.).

The salt pilot light (3) and the rinse aid light (2) comes on if salt or rinse aid are low and the programme selector light (5) flashes.

The number corresponding to the programme selected previously appears in the digital display.

OFF

When the wash programme has ended, the dishwasher stops automatically (an intermittent audible signal lasting about 5 seconds informs you of this) and two zeros appear in the digital display.

To switch off the dishwasher at the end of the programme, press this button again.

2. RINSE AID indicator light

This indicator light will flash when the rinse aid has run out, to remind you to top it up.

3. SALT indicator light

This indicator light will flash when the salt has run out, to remind you to top it up.

If your water is level «0» there is no need of salt, therefore the salt indicator light will always remain on.

4. Digital display

5. PROGRAMME SELECTION button

To select the required programme, press this button until the number corresponding to the chosen programme appears in the digital display (4) (see wash programme guide). To start the programme, simply close the dishwasher door. A long audible signal (about one second) informs you that the programme is starting.

If you open the door whilst the programme is in operation in the digital display appears the remaining time (in minutes) to the end of the washing cycle.

6. SID Indicator Light

This pilot light comes on when programmes 2, 3, 5, and 8 are selected to remind you that these programmes require a small amount of detergent to be added in the Super Intensity Dispenser «SID» located in the centre of the upper basket. Follow the instructions given in the «Washing programme» chart.

Attention: if the «half load» (7) option is selected the SID light will illuminate only with programme 2 (Intensive 70°C).

7. Half load UPPER/LOWER pushbutton

By pressing this button, washing can be confined to a single basket instead of both. Depress the button until the indicator light corresponding to the basket selected illuminates.

This is very useful and economical when only a few dishes need washing.

Remember to load all the dishes into the basket selected.

Do however follow the instructions given in the section «Loading your machine».

8. ECO DRY button

By pressing this button the last rinse and the hot air drying cycle will be shorten, making a considerable energy saving.

The corresponding indicator light comes on.

9. NO DRY button

By pressing this button the last rinse water will be cold and hot air drying cycle will be omitted.

The corresponding pilot light comes on.

If both the ECO DRY and NO DRY indicator lights are out, the full drying cycle will be carried out.

10. DELAY START button

The start of the programme can be delayed by a minimum of 1 hour, up to a maximum 9 hours.

How to set DELAY START

By pressing the button,  will appear on the digital display; this means that you have delayed the start of the programme by 1 hour.

By pressing the button repeatedly, you can delay the start of the programme up to a maximum of 9 hours.

By pressing the button one more time you go back to the programme setting.

Press the button again to select the number of hours by which you wish to delay the programme start, up to a maximum of 9.

Close the dishwasher door to start the countdown: a long audible signal (about one second) informs you that the function is active. If you open the door again you will see, in the display (4), how long there is to go (in hours) before the programme starts. A flashing «H» in the digital display means that the delayed start function has been activated. Opening the door has no effect on a countdown which has already been started.

11. CANCEL / programme change button

If you wish to cancel a programme which is already running or a setting which has just been made, press this button for about two seconds until the short «instruction accepted» signal is heard. In the digital display will appear  to indicate that the dishwasher has been reset and that a new programme and new options can be selected.

The Water Softener

Water contains varying amounts of lime and mineral salts depending on the area in which you live: these are deposited on the dishes leaving white marks.

The higher the content of these salts, the harder your water will be. The «hardness» level is measured on 3 equivalent scales: French Degrees, German Degrees or Parts Per Million.

Contact your local Water Authority to find the exact water hardness level for your area.

The dishwasher is equipped with a softener which uses special dishwasher salt to provide lime-free (softened) water. The softener can treat water hardness up to 50 German degrees via 9 adjustment levels.

Find on the table below the level corresponding to the hardness of your water and the required adjustments:

Level	French Degrees (°TH)	German Degrees (°dH)	ppm (Parts per Million)
0	0- 4	0- 8	0- 80
1	5- 8	9-14	81-140
2	9-11	15-20	141-200
3	12-17	21-30	201-300
*4	18-22	31-40	301-400
5	23-28	41-50	401-500
6	29-33	51-60	501-600
7	34-39	61-70	601-700
8	40-45	71-80	701-800
9	46-50	81-90	801-900

*The water softener is factory set at level 4 as this suits most users.

To set the dishwasher to a different level, proceed as follows:

- Press the ON/OFF pushbutton on.
- Press the UPPER/LOWER and DELAY START simultaneously for about 5 seconds until the short «instruction accepted» signal is heard; an L followed by number 4 (the hardness level set in factory) will appear in the digital display **L4**.

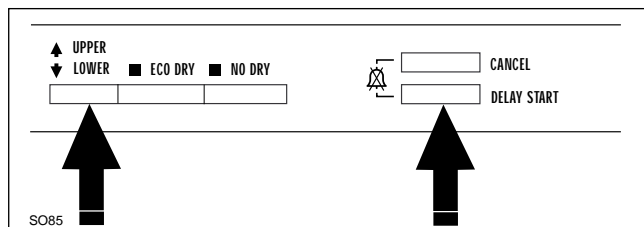

- Press the UPPER/LOWER button as many times as necessary to make the required level appear in the display. The level increases by 1 each time the button is pressed.
- 5 seconds after this button has last been pressed, the machine returns to programme setting mode and memorises the level set.

Important

Salt MUST be used regularly from level 1 upward.

If your water is «level 0» it is already soft and therefore there is no need to use salt.

Filling with Salt

Only use salt designed specifically for use in dishwashers. Other types of salt i.e.: table/cooking salt contain high percentages of other substances which may reduce the efficiency of the softener. To fill with salt, unscrew the cap of the salt container.

Pour about half a litre of water inside the container, or until it is full (this is necessary only before filling with salt for the first time).

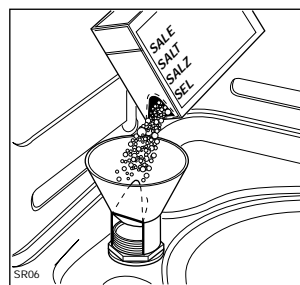

Then, using the funnel provided, pour in the salt until the container is full (approx. 1,5÷1,8 kg). Do not worry if water over flows from the unit when filling with salt this is quite normal.

Replace the cap making sure that there is no trace of salt on the screw thread or on the gasket.

Screw the cap on tightly.

If you have inadvertently spilled salt select a wash programme immediately after.

All that is then required is to periodically top up the container with salt. You are reminded of this by the Salt Indicator Light **S**; on the control panel illuminates when the salt has finished.

The salt container always has some water inside which will normally overflow when refilling with salt.

Important: The Salt Indicator Light **S** on the control panel can remain illuminated for 2-6 hours after the salt has been replenished, assuring the dishwasher remains switched on. If you are using salts that take longer to dissolve then this can take longer. The function of the dishwasher is not affected.

Caution: Only fill with salt just before starting one of the complete washing programmes (not the Rinse and Hold programme). This will prevent any grains of salt or salty water, which may have been spilled, remaining on the bottom of the machine for any period of time. This could cause corrosion.

Rinse Aid

This liquid gives the dishes a shiny finish and improves drying. It is automatically added during the hot rinse. The dispenser, which is positioned inside the door, holds about 110 ml of rinse aid, which is sufficient for 16-40 dishwashing programmes, depending upon the dosage setting.

Filling with Rinse Aid

Open the container by turning the lid (A) anticlockwise. Add rinse aid until the container is completely full (approx. 110 ml). The indicator (B) will be completely dark.

Top up with rinse aid when the RINSE AID indicator light  on the control panel flashes.

Remember to CLOSE the lid after every refill.

Caution

Clean up any rinse aid spilt during filling with an absorbent cloth to avoid excess foaming during the next wash.

Adjusting the Dose

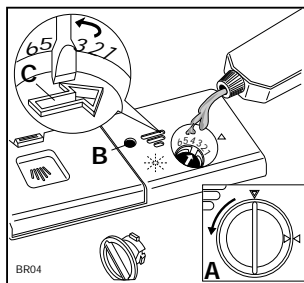

According to the finish and drying results obtained, adjust the dose of rinse aid by means of the 6 position selector (C) (position 1 - minimum dose, position 6 - maximum dose).

Gradually increase the dose if there are drops of water or lime spots on the dishes after washing. Reduce it if there are sticky whitish streaks on the dishes.

Caution: Do not put liquid detergent into the rinse aid compartment.

Use of Detergent

Before starting any of the dishwashing programmes, except for the rinse and hold programme, load the detergent in the dispenser.

Use only tablets, powder or liquid detergents specifically designed for domestic dishwashers.

Unsuitable detergents (such as those for washing by hand) do not contain the right ingredients for machine washing and hamper correct functioning of the machine.

To open the dispenser lid, pull the catch (D). This will open it.

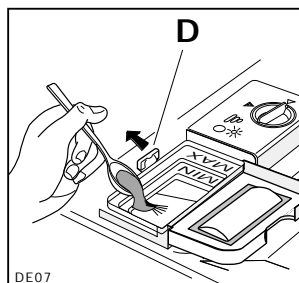

To help you to correctly dose the right amount of detergent, inside the container there are two reference marks.

- MIN = 15 ml
- MAX = 30 ml

After filling the dispenser with detergent, close the lid. At the end of any washing programme the lid is always open, ready for the next wash.

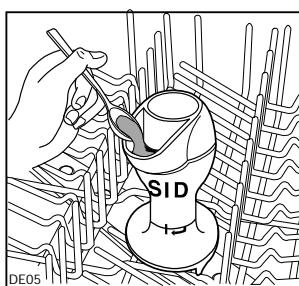

All the programmes with a warm prewash require a small amount of detergent of approximately 5 g to be poured in the SID located in the centre of the upper basket.

For the Intensive programme

For this programme, suitable for particularly dirty pans and dishes, is selected, an extra 10 g of detergent must be placed in the SID.

Pull out the basket and add detergent.

Important: Never use your dishwasher without the SID dispenser.

Since SID also ensures correct distribution of the water to the upper spray arm, running the dishwasher without it will impair the washing results.

The amount of detergent to be used varies depending on how soiled the dishes are and the type of dishes being washed. We recommend the amounts shown in the programme chart on the next pages.

Since not all detergents are the same, you should also consult the instructions on the packet.

Remember that insufficient quantities of detergent will produce poor washing results whereas an excessive amount of detergent does not improve washing results and is also wasteful.

Using no more than the correct amount of detergent also contributes to reducing pollution.

Zanussi recommends the use of FINISH dishwasher detergent.

Phosphate free detergents with enzymes

These new detergents, although welcome from an ecological point of view, react far more susceptibly to water hardness than conventional products.

Therefore, in order to avoid white lime deposits on crockery and the inner tub, you should add salt in the water softener even if the hardness of your water is as low as 4° dH (7 TH°), when using these new detergents.

Loading your Machine

Before placing dishes in the machine, remove any scraps of food from the plates (small bones, toothpicks, fish bones, scraps of meat and vegetables, fruit skins etc.) to avoid clogging the filters and consequently reducing performance.

Open the door and slide out the baskets to load the dishes.

Use of the Lower Basket

The lower basket is designed to take saucepans, lids, plates (up to 27 cm in diameter), salad bowls, cutlery etc.

Serving dishes and large lids should be arranged around the edge of the basket, ensuring that the upper spray arm can turn freely.

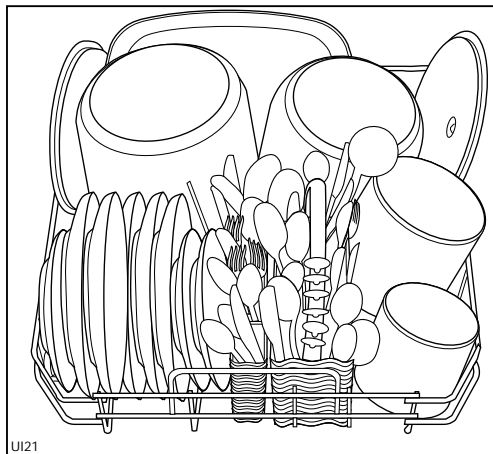
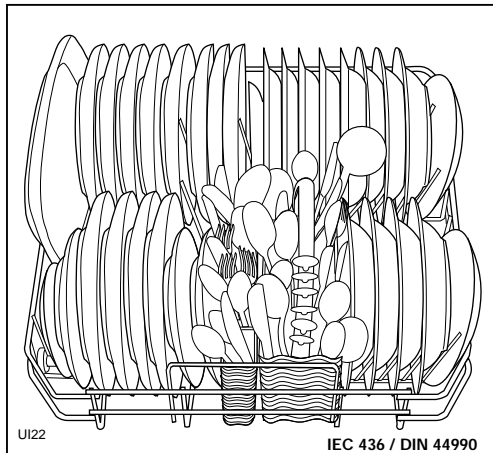

Cutlery should be placed in the removable cutlery basket with the handles facing downwards. If the handles protrude from the bottom of the basket, obstructing the lower spray arm, load the cutlery with the handles facing upward.

Mix spoons with the other cutlery to prevent them sticking together.

Teaspoons may be loaded into the special slots provided in the cutlery basket handle.

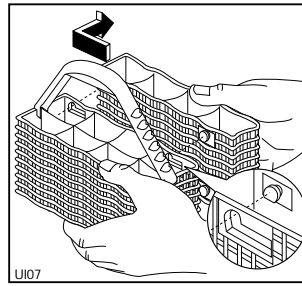

The cutlery basket is in two parts which can be separated to give greater loading flexibility. To separate the two parts, slide them horizontally in opposite directions and pull them apart. To re-assemble, reverse the procedure.

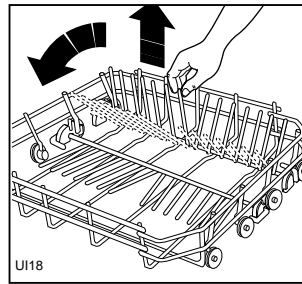

The two rear rows of prongs on the lower basket can be easily lowered to allow you to load pots, pans and bowls.

To lower the prongs: slightly pull them upward and let them drop down (see picture); to bring them back to the standing position, just pull them up again.

Use of the Upper Basket

The upper basket is designed for plates (dessert plates, saucers, dinner plates up to 24 cm in diameter), salad bowls, cups and glasses; these should be arranged as shown in the pictures. Glasses with long stems can be placed upside-down in the raised cup-racks.

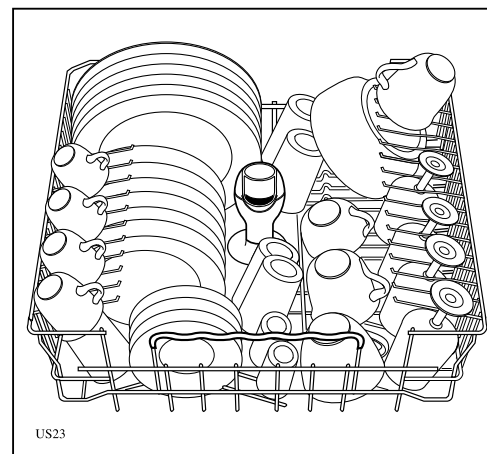
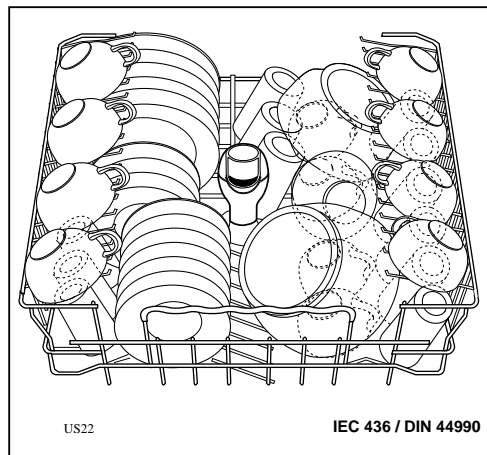

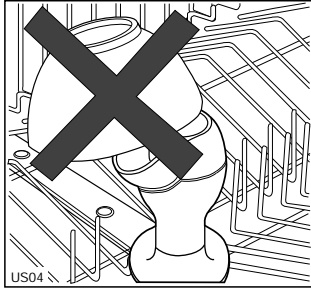

Caution

When loading the dishes, ensure that you do not cover the water inlet funnel in the middle of the upper basket.

Before closing the door, ensure that the spray arms can rotate freely.

Adjusting the Height of the Upper Basket

If washing very large plates (over 27 cm and up to 31 cm in diameter) you can load them in the lower basket after moving the upper basket to the higher position as follows:

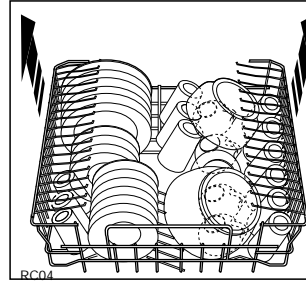

- pull out the basket;
- grasp it on the two sides and pull it upwards until the mechanism is engaged and the basket is stable.

When the top basket is in the higher position it will only take plates up to 20

cm in diameter and you will not be able to use the raised cup-racks.

To put the basket back in the lower position, grasp the two sides, pull upwards again, then allow the basket to drop back down slowly, keeping hold of it.

Warning: never lift or lower the basket on one side only.

HELPFUL HINTS

For Best Washing Results:

Before loading, remove all scraps of food and soak very heavily soiled pots and pans.

Always arrange saucepans, cups and glasses etc. up side-down.

Tilt items with convex or concave surfaces so that the water drains off easily.

Long items of cutlery such as ladles, carving knives etc. should be positioned horizontally in the upper basket.

Avoid contact between the dishes as far as possible; correct arrangement of the items will give better washing results.

Light items (plastic bowls etc.) should be loaded in the upper basket and arranged so that they do not move during washing.

You will improve drying results by leaving the dishwasher door ajar for at least 15-30 minutes as soon as the programme finishes.

To Save Energy

Do not prewash dishes under running water.

Place dishes in the machine immediately after every meal and wait until the dishwasher is full before washing.

If necessary run the Rinse and Hold programme (see Programme Chart on the following pages), so that any food scraps do not become caked on the dishes while you are waiting to run the complete wash programme. Select an economic programme when the baskets are not very full and/or when the dishes are not very soiled, following the instructions given in the Programme Chart (ECO programme, QUICK WASH programme).

You can also select NO DRYING or ECO DRYING, in this case the drying will be less effective.

Care must be taken when opening the door, as steam will escape.

Items not Suitable for Dishwashers

The following should not be washed in the dishwasher:

Cutlery or dishes with wooden or horn handles or glued parts.

Handmade items, wooden objects, antiques or hand painted china.

Certain types of decoration can discolour when washed in a dishwasher.

Crystal-ware and plastic objects, if not guaranteed dishwasher-proof, should be washed by hand. You are advised to place them in the upper basket and to select a delicate programme.

Certain types of glass can also become opaque after being washed several times in a dishwasher.

Silver cutlery tends to go black if mixed with steel cutlery. Place it in the cutlery basket separate from the others.



Iron and cast iron objects can rust and stain other items.

Aluminium tends to go black; copper, pewter and brass tend to stain.

Caution: You are advised not to load very small or plastic items which can fall through the baskets.

Note: When buying new dishes, ensure that they are dishwasher-proof.

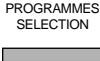
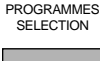
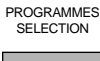
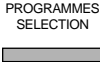
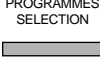
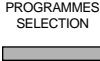
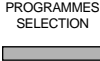
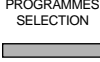
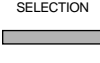
WASHING PROGRAMMES

Programme	Degree of soil and type of load	Recommended programme	Required Pushbuttons	Recommended quantity of detergent		Cycle Description
				in the dispenser	in the SID (Super Intensity Dispenser)	
1	Any. Partial load (to be completed later in the day).	RINSE AND HOLD	 DI DO	/	/	1 cold rinse (to avoid food scraps from sticking to the dishes).
2	Heavy soil. Crockery, cutlery, pots and pans.	INTENSIVE 70°C	 DI DO	2 level dessert spoons (20 g)	1 level dessert spoon (10 g)	Prewash up to 50°C Main wash up to 70°C 2 cold rinses 1 hot rinse up to 70°C Thermal drying
3	Normal soil. Crockery, cutlery, pots and pans.	* NORMAL WITH PREWASH 65°C	 DI DO	1 heaped dessert spoon (15 g)	1 level dessert spoon (10 g)	Prewash up to 50°C Main wash up to 65°C 1 cold rinse 1 hot rinse up to 65°C Thermal drying
4	Normal soil Crockery and cutlery, pots and pans.	NORMAL NO PREWASH 65°C	 DI DO	2 heaped dessert spoons (25 g)	/	Main wash up to 65°C 1 cold rinse 1 hot rinse up to 65°C Thermal drying
5	Normal soil. Crockery and cutlery.	ECONOMY WITH PREWASH 55°C	 DI DO	1 heaped dessert spoon (15 g)	1 level dessert spoon (10 g)	Prewash up to 50°C Main wash up to 55°C 1 cold rinse 1 hot rinse up to 65°C Thermal drying
6	Normal soil. Crockery and cutlery.	ECONOMY NO PREWASH 55°C	 DI DO	2 heaped dessert spoons (25 g)	/	Main wash up to 55°C 1 cold rinse 1 hot rinse up to 65°C Thermal drying
7	Light soil. China and glassware with delicate decorations.	DELICATE WITH PREWASH 45°C	 DI DO	1 heaped dessert spoon (15 g)	/	Prewash up to 40°C Main wash up to 45°C 1 cold rinse 1 hot rinse up to 60°C Thermal drying
8	Light soil. China and glassware with delicate decorations.	DELICATE NO PREWASH 45°C	 DI DO	1 heaped dessert spoon (15 g)	/	Main wash up to 45°C 1 cold rinse 1 hot rinse up to 60°C Thermal drying
9	Light soil. Crockery and party crockery	*QUICK WASH 55°C	 DI DO	1 heaped dessert spoon (15 g)	/	Main wash up to 50°C 2 cold rinses
10	Crockery and cutlery	PLATE WARMER 70°C	 DI DO	This is a programme designed both to heat plates before serving or remove dust from dishes which have not been used for a long time.		1 hot rinse up to 70°C Thermal drying

***This programme is equivalent to IEC436/DIN 44990**

Standard place setting: 12

Recommended quantity of detergent: 20 g in the dispenser
5 g in the SID.

****This is a special programme for quick washing (approx. 33 minutes) a full load of lightly soiled dishes, glasses and crockery (except pots) so that you may re-use them promptly. Due to the shortness of this programme, no drying phase is provided. (pilot light of NO DRY illuminated). If you wish an economic drying select the ECO DRY button.**

Remember if you select the option half load UPPER/LOWER reduce the quantity of detergent and only for programme n.2 (Intensive) pour detergent in the SID.

Operating Sequence

1 Check that the filters are clean

(see cleaning instructions)

2 Switch on at the main supply

3 Depress the ON/OFF pushbutton

In the display appears the number of the last programme selected and the «PROGRAMMES SELECTION» pilot light flashes.

4 Check that there is salt and rinse aid

The indicator lights will flash if they need topping up.

5 Load the dishes

Remove larger scraps of food.

Pull the lower basket out and arrange the saucepans, plates and cutlery in it.

Pull the upper basket out and arrange the plates, saucers, glasses and cups etc. in it.

Slide the baskets back into the machine.

Ensure that the spray arms can rotate freely.

6 Measure out detergent

Pour the required amount of detergent into the dispenser according to the indications in the Washing Programmes chart and close the lid.

7 Set the programme

Press the «PROGRAMME SELECTION» button until the number corresponding to the required programme appears in the display. The indicator light continues to flash until the programme is started.

The following options may also be selected:

- ECO DRY: by pressing the relevant button. The pilot light corresponding to the selection made comes on.
- NO DRY: by pressing the relevant button. The pilot light corresponding to the selection made comes on
- UPPER/LOWER: by pressing this button washing can be confined to a single basket. Depress the button until the pilot light corresponding to the basket selected illuminates (upper or lower). Always remember to load all the dishes into the basket selected if you choose this option.
- DELAY START: by depressing this button the start of a programme can be delayed from a minimum of 1 hour up to 9 hours.

7 Starting the wash programme

Open the water tap.

Close the dishwasher door.

An audible signal lasting about 1 second informs you that the programme has started.

If a delayed start has been selected, the dishwasher starts the countdown and the number of hours to go before the programme starts appears in the display. A flashing H indicates that the function is active. Once the set delay has elapsed, the programme starts automatically.

If you wish to interrupt the wash programme at any time, press the ON/OFF  button. To restart the machine, press this button again and the wash programme will resume at the point at which it was interrupted.

8 At the end of the wash programme

The machine stops automatically. An intermittent audible signal lasting about 5 seconds informs you that the programme has finished. In the digital display appears . This signal remains until a button is pressed.

Switch of the dishwasher by pressing the ON/OFF  button.

Turn off the water tap, and switch off at the mains supply.

Wait a few minutes before removing the dishes; in this way they will be cooler and the drying will be improved.

Empty the lower basket first and then the upper one; this will avoid water dripping from the upper basket onto the dishes in the lower one.

Caution

In general it is not advisable to open the door while the machine is working; if the door is opened however, a safety device ensures that the machine stops.

9 Cancel the wash programme

To cancel a wash programme which is running, press the «CANCEL» button until the short «instruction accepted» signal (about 2 seconds) is heard. The two zeros appear  in the digital display indicating that the previous setting has been cancelled and a new programme can now be selected.

MAINTENANCE AND CLEANING

Cleaning the Central Filter (After each wash)

Scraps of food can sometimes accumulate in the central filter (A) and should be periodically removed by rinsing the filter under running water.

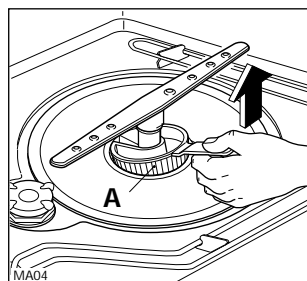

To remove the filter, simply pull it outward by the handle.

Once cleaned, refit the filter by pushing it back to its original position until it engages.

Cleaning the Large Filter (Every two months)

If necessary clean the large filter (B) on both sides under running water, using a brush.

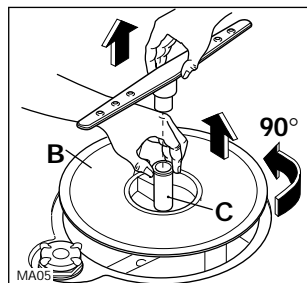

To take it out remove the spray arm by pulling it upward on one side, turn the column (C) anticlockwise by 90° and then slide out the filter.

Once cleaned refit it following the above instructions in reverse order.

Ensure the filter is in its original position, the handle of filter (A) should be pointing towards the front of the appliance.

Caution: the dishwasher must not be used without filters.

Incorrect repositioning of the filters will produce poor washing results.

Cleaning of the filters is vital to ensure correct operation of the machine.

Internal and External Cleaning

You must ensure that the seals around the door, the detergent and rinse aid dispensers are cleaned regularly with a damp cloth.

We recommend the use of a specific dishwasher cleaner every 3 months, or run a wash programme without dishes using detergent.

Check that the spray arm nozzles are not obstructed.

To remove the bottom spray arm, pull the arm upwards holding one end. To clean the nozzles of the top spray arm, slide out the top basket whereby the spray arm will become accessible. If you need to remove it, take away the SID dispenser (see instructions below) and unscrew the retaining nut.

Clean the external surfaces of the machine and control panel with a soft damp cloth. If necessary use only neutral detergents. Never use abrasive products, scouring pads or solvents (acetone, trichloroethylene etc.).

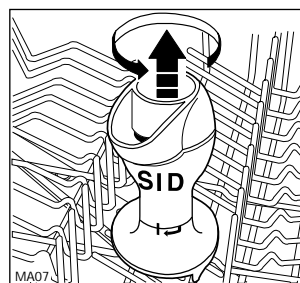

Check that the Super Intensity Dispenser (SID) is not clogged with detergent residue or soil. If necessary, rinse it under running water after having removed it from the basket by twisting it anticlockwise and pulling it upwards.

Refit the dispenser by following the above instructions in reverse order. Fasten it back onto the support by turning it clockwise.

Important: Never use your dishwasher without the SID dispenser.

Prolonged Periods of Non-Operation

If you are not using the machine for any period of time you are advised to:

unplug the appliance and turn off the water;

fill the rinse aid dispenser;

leave the door ajar to prevent the formation of unpleasant smells;

leave the inside of the machine clean.

Frost Precautions

Avoid placing the machine in a location where the temperature is below 0°C.

If this is unavoidable, empty the machine, close the water inlet tap, disconnect the water inlet pipe and empty it.

Moving the Machine

If you have to move the machine (you are moving house etc...):

unplug it;

turn off the water tap;

remove the water inlet and discharge hoses;

pull the machine out together with the hoses.

Caution: avoid over tilting the machine during transport.

SERVICING

Certain problems are due to lack of simple maintenance or oversights and can be solved easily without having to call out an engineer. Therefore before calling the Service, consult the check list here below.

The following alarms, (A3, A5, A6, A1, A2, A7) flash in the digital display window. The dishwasher fails to start or stops during operation; all the lights are out except for the alarm in the digital display, all buttons are inoperative except for the ON/OFF button.

If the dishwasher displays the following fault codes please carry out the following checks.

If A3 is displayed or the dishwasher stops

- The spray arms are not rotating. Check the crockery is loaded correctly.
- The filters are blocked Clean the filters and press the start button.

If A5 is displayed or the machine will not fill with water

- The water tap is off. Turn the water tap on and press the start button.
- The water supply has been cut off. Wait for it to be restored then press the start button.
- The inlet hose is kinked. Straighten the hose and press the start button.
- The water inlet hose is blocked. Clean the filter at the end of the inlet hose and press the start button.
- The filters are blocked. Clean the filters and press the start button.

If A6 is displayed or the machine will not drain

- The drain hose is kinked. Straighten the hose and press the start button.
- The sink drain is blocked. Clear the blockage and press the start button.
- The drain hose extension is not correct. Follow the instructions for connecting to the waste and press the start button.
- There is no air vent in the end of the drain hose.

If after these checks the fault codes remain displayed or the fault codes A1, A2, A4 or A7 appear contact your local Zanussi Service Centre.

For washing or drying problems, please carry out the checks listed below:

The dishes are not clean (poor wash);

- The baskets are too full.
- The dishes have not been arranged correctly.
- The spray arms do not rotate.
- The spray arms are blocked.
- The water inlet funnel in the centre of the upper basket is covered by dishes.
- The filters are clogged.
- The filters are not in position.
- Not enough detergent has been used, or it is unsuitable.
- The detergent is old or has gone hard.
- The salt container cap is not properly closed.
- The washing programme selected is too gentle.

Visible lime deposits or white film on the dishes

- There is no salt or the softener has not been adjusted to the hardness of the water.

The machine is noisy;

- The dishes are rattling against each other.
- The spray arms are knocking against the dishes.

The dishes are not quite dry;

- The dishes have been left too long inside the machine.
- The rinse aid has run out or too little is being used.

The door is difficult to close;

- The dishwasher is not level or is not properly built-in.

If, after the above checks the fault persists, call your local Zanussi Service Centre, whose address can be found in the accompanying Customer Care Booklet, and can also be found in your local telephone directory under «Z». Please make sure you give the model and serial number of the appliance. This information can be found on the rating plate located on the right-hand side of the dishwasher door (see picture).

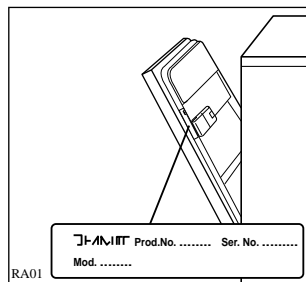

Original spare parts can be purchased from Zanussi Service Centres.

In guarantee customers should ensure that the above checks have been made as the engineer will make a charge if the fault is not a mechanical or electrical breakdown.

Please note that proof of purchase is required for any in-guarantee service calls.

Service details - adhesive label

When you return your guarantee card to Zanussi Ltd. you will receive an «Appliance Guarantee And Maintenance Record» together with an adhesive label (containing the telephone number of your local Zanussi Service Centre). The label can be adhered to the machine or adjacent furniture.

Protection against flooding

To protect your dishwasher from water damage, it is equipped with a flood protection system.

It features an flood protection (float switch in the floor tray). This comes into operation in the event of any water leaks in the machine, while the machine is switched on.

When the flood protection comes into operation the dishwasher remains inoperative and the A5 fault code will be displayed. To repair the machine, call the Service Centre.

BUILDING-IN

Building-in features

This dishwasher is designed to be fitted under a kitchen counter or sink.

In either case, it is essential that the recess dimensions indicated in the picture are followed.

No further openings for venting of the dishwasher are required, but only to let the water fill and drain hoses and power supply cable pass through.

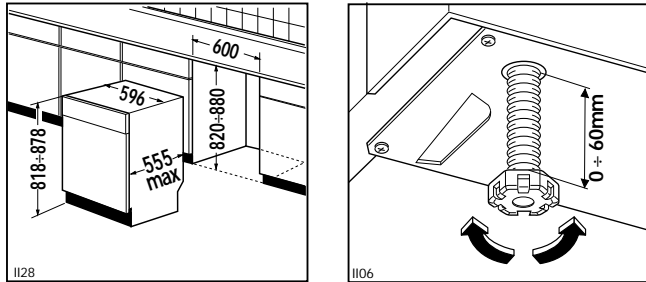

The recess height may be anywhere between 820 and 880 mm from the floor since the dishwasher incorporates levelling feet adjustable over a wide range (max 60 mm).

Adjust the height of the appliance by turning these feet.

A distance of 2 mm should be allowed between the top of the dishwasher and the counter top.

Fitting under a counter (kitchen worktop or sink)

It is absolutely essential that the dishwasher is disconnected from the electricity supply before gaining access to any internal component.

Fit the dishwasher into the appropriate housing space and connect it. Make sure that the water fill and drain hoses and the power supply cable are not bent or kinked.

Fitting the panel onto the door

The door on this model is designed for the overlay of a panel having the following dimensions:

Width: 596 mm

Height: 644 to 714 mm max

Thickness: 20 mm max

Weight: 2 to 7.5 kg max

Note:

The panel height should not be more than what indicated, otherwise complete opening of the door will no longer be possible as the panel hits against the dishwasher plinth.

Mounting of decor panel onto the door

The height of the panel depends on the height of the plinth of adjacent kitchen units (see kitchen plinth adjustment).

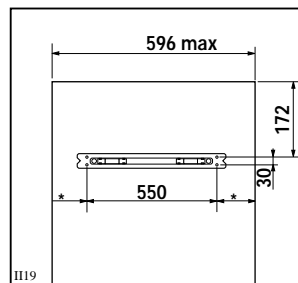

The panel must be fitted with a handle, as the dishwasher handle will be hidden by the panel.

Drill the panel with a \varnothing 2x12 bit according to the dimensions indicated in the figure.

Fix the cross bar onto the panel using four 3.5x16 screws provided. Reduce the length of fixing screws according to thickness of panel.

If for aesthetic matching the panel is provided with a false drawer (fitted or carved on the panel itself), the two brackets provided should also be used.

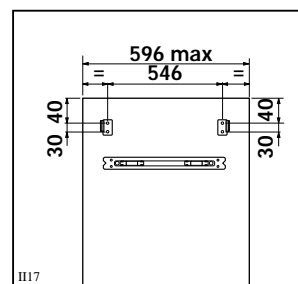

Fix the brackets according to the measurements shown in the figure, by using four 3.5 x 16 screws.

Reduce the length of fixing screws according to thickness of panel.

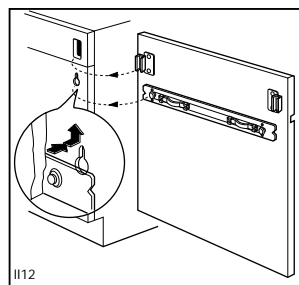

Mount the decor panel by inserting the two pivots of the cross-bar into the slotted holes of the door.

Lift the decor panel until perfect alignment with the fascia panel is obtained: if the two brackets have also been used, they will automatically engage in the special holes provided on the dishwasher door.

Reduce the length of fixing screws according to thickness of panel.

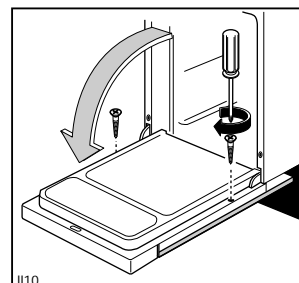

Once the correct position has been found, open the door and fasten the decor panel on the lower section by means of the two long 4x40 screws provided, using the holes through the inner door (see fig.).

Fixing to the adjacent units

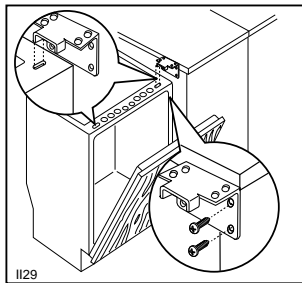

Insert the two fixing brackets into the slots provided in the top front part of the dishwasher, as shown in the figure.

Secure the brackets to adjacent units using two 3,5 x 16 screws for each bracket.

Important!

The dishwasher must be secured against tilting. Therefore, make sure that the counter it is fitted under, is suitably secured to a fixed structure (adjacent kitchen cabinets, wall).

Attention!

When the dishwasher is secured to the kitchen cabinets, do not drill any holes into the sides of the machine.

Adjusting the door balance

The door of the dishwasher is balanced when it is open in any position.

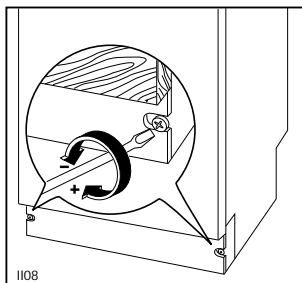

Fitting the decor panel may sometimes affect this balance. In this case it will be necessary to adjust the balance as follows: Half-open the door and regulate the screws located on the kick plate.

By screwing or unscrewing these screws, the tension of the door balancing springs is increased or decreased respectively.

Attention!

The weight of the panel should be within the limits given in the "dimensions of the panel", otherwise balancing the door will not be possible.

Levelling

Make sure that the dishwasher door closes properly, without rubbing on sides. Otherwise level the machine by slightly screwing or unscrewing the two front feet until perfect closure of the door is reached.

Kitchen plinth adjustment

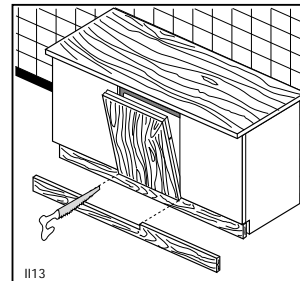

To allow correct opening of the door it is sometimes necessary to cut the kitchen plinth. Refer to the cutting table below.

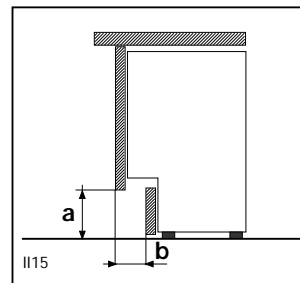

According to dimensions of (a) and (b) as shown on the figure, you will find on the following table the depth (x) of the cut to be made on the plinth.

The dimensions (a) and (b) of the table are those more frequently used in the kitchen furnitures.

		Height (a)*							
		170	160	150	140	130	120	110	100
Depth (b)*	40	136	131	125	118	110	100	93	85
	50	135	131	125	118	110	102	92	85
	60	137	132	125	118	110	102	94	85
	70	138	134	128	120	110	104	95	85
	80	/	139	130	124	115	105	98	88
	90	/	/	138	129	120	110	100	90
	100	/	/	/	135	125	115	105	95
			X						

*dimensions in mm

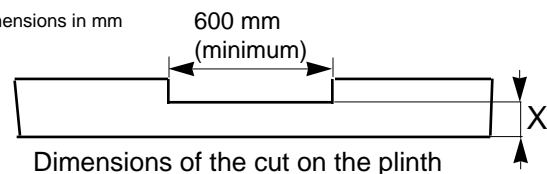

PEACE OF MIND FOR TWENTY FOUR MONTHS

Zanussi guarantee conditions

This guarantee is in addition to your statutory and other legal rights.

We, Zanussi Ltd., undertake that if, within twenty four months of the date of the purchase, this ZANUSSI appliance or any part thereof is proved to be defective by reason only of faulty workmanship or materials, we will, at our option, repair or replace the same **FREE OF ANY CHARGE** for labour, materials or carriage on condition that:

- The appliance has been correctly installed and used only on the electricity supply stated on the rating plate.
- The appliance has been used for normal domestic purposes only, and in accordance with the manufacturer's operating and maintenance instructions.
- The appliance has not been serviced, maintained, repaired, taken apart or tampered with by any person not authorised by us.

All service work under this guarantee must be undertaken by a Zanussi Service Force Centre.

Home visits are made between **8.30 am** and **5.30 pm** Monday to Friday. Visits may be available outside these hours in which case a **premium** will be charged.

Any appliance or defective part replaced shall become our property.

Exclusions

This guarantee does not cover:

- Damage or calls resulting from transportation, improper use or neglect, the replacement of any light bulbs or removable parts of glass or plastic.
- Costs incurred for calls to put right machines improperly installed or calls to machines outside the UK and the Republic of Ireland.
- Appliances found to be in use within a commercial or similar environment, plus those which are the subject to rental agreements.
- Products of Zanussi manufacture which are **NOT** marketed by Zanussi Ltd.
- EU Countries - The standard guarantee is applicable but subject to the owner's responsibility and cost to ensure the appliance meets the standards set by the country to which the product is taken. The Zanussi company in the country concerned will be pleased to advise further. Sight of your purchase receipt will be required by them.



Total Chlorine free



Free Manuals Download Website

<http://myh66.com>

<http://usermanuals.us>

<http://www.somanuals.com>

<http://www.4manuals.cc>

<http://www.manual-lib.com>

<http://www.404manual.com>

<http://www.luxmanual.com>

<http://aubethermostatmanual.com>

Golf course search by state

<http://golfingnear.com>

Email search by domain

<http://emailbydomain.com>

Auto manuals search

<http://auto.somanuals.com>

TV manuals search

<http://tv.somanuals.com>