

EN

User manual

Fridge-Freezer

# USER MANUAL

ZBB26650SA

**ZANUSSI**

# Contents

Safety information .....	2	Care and cleaning .....	7
Control panel .....	4	What to do if. . . ..	8
First use .....	6	Technical data .....	10
Daily use .....	6	Installation .....	10
Helpful hints and tips .....	7	Environmental concerns .....	14

Subject to change without notice.

## Safety information

In the interest of your safety and to ensure the correct use, before installing and first using the appliance, read this user manual carefully, including its hints and warnings.

To avoid unnecessary mistakes and accidents, it is important to ensure that all people using the appliance are thoroughly familiar with its operation and safety features. Save these instructions and make sure that they remain with the appliance if it is moved or sold, so that everyone using it through its life will be properly informed on appliance use and safety.

For the safety of life and property keep the precautions of these user's instructions as the manufacturer is not responsible for damages caused by omission.

### Children and vulnerable people safety

- This appliance is not intended for use by persons (including children) with reduced physical, sensory or mental capabilities, or lack of experience and knowledge, unless they have been given supervision or instruction concerning use of the appliance by a person responsible for their safety.  
Children should be supervised to ensure that they do not play with the appliance.
- Keep all packaging well away from children. There is risk of suffocation.
- If you are discarding the appliance pull the plug out of the socket, cut the connection cable (as close to the appliance as you can) and remove the door to prevent playing children to suffer electric shock or to close themselves into it.
- If this appliance featuring magnetic door seals is to replace an older appliance having a spring lock (latch) on the door or lid, be sure to make that spring lock unusable before you discard the old appliance. This will prevent it from becoming a death trap for a child.

### General safety

#### Warning!

Keep ventilation openings, in the appliance enclosure or in the built-in structure, clear of obstruction.

- The appliance is intended for keeping foodstuff and/or beverages in a normal household as explained in this instruction booklet.
- Do not use a mechanical device or any artificial means to speed up the thawing process.
- Do not use other electrical appliances (such as ice cream makers) inside of refrigerating appliances, unless they are approved for this purpose by the manufacturer.
- Do not damage the refrigerant circuit.
- The refrigerant isobutane (R600a) is contained within the refrigerant circuit of the appliance, a natural gas with a high level of environmental compatibility, which is nevertheless flammable.  
During transportation and installation of the appliance, be certain that none of the components of the refrigerant circuit become damaged.  
If the refrigerant circuit should become damaged:
  - avoid open flames and sources of ignition
  - thoroughly ventilate the room in which the appliance is situated
- It is dangerous to alter the specifications or modify this product in any way. Any damage to the cord may cause a short-circuit, fire and/or electric shock.

 **Warning!** Any electrical component (power cord, plug, compressor) must be replaced by a certified service agent or qualified service personnel to avoid hazard.

1. Power cord must not be lengthened.

2. Make sure that the power plug is not squashed or damaged by the back of the appliance. A squashed or damaged power plug may overheat and cause a fire.
  3. Make sure that you can come to the mains plug of the appliance.
  4. Do not pull the mains cable.
  5. If the power plug socket is loose, do not insert the power plug. There is a risk of electric shock or fire.
  6. You must not operate the appliance without the lamp cover (if foreseen) of interior lighting.
- This appliance is heavy. Care should be taken when moving it.
  - Do not remove nor touch items from the freezer compartment if your hands are damp/wet, as this could cause skin abrasions or frost/freezer burns.
  - Avoid prolonged exposure of the appliance to direct sunlight.
  - Bulb lamps (if foreseen) used in this appliance are special purpose lamps selected for household appliances use only. They are not suitable for household room illumination.

### Daily Use

- Do not put hot pot on the plastic parts in the appliance.
- Do not store flammable gas and liquid in the appliance, because they may explode.
- Do not place food products directly against the air outlet on the rear wall. (If the appliance is Frost Free)
- Frozen food must not be re-frozen once it has been thawed out.
- Store pre-packed frozen food in accordance with the frozen food manufacturer's instructions.
- Appliance's manufacturers storage recommendations should be strictly adhered to. Refer to relevant instructions.
- Do not place carbonated or fizzy drinks in the freezer compartment as it creates pressure on the container, which may cause it to explode, resulting in damage to the appliance.
- Ice lollies can cause frost burns if consumed straight from the appliance.

### Care and cleaning

- Before maintenance, switch off the appliance and disconnect the mains plug from the mains socket.

- Do not clean the appliance with metal objects.
- Do not use sharp objects to remove frost from the appliance. Use a plastic scraper.
- Regularly examine the drain in the refrigerator for defrosted water. If necessary, clean the drain. If the drain is blocked, water will collect in the bottom of the appliance.

### Installation

**Important!** For electrical connection carefully follow the instructions given in specific paragraphs.

- Unpack the appliance and check if there are damages on it. Do not connect the appliance if it is damaged. Report possible damages immediately to the place you bought it. In that case retain packing.
- It is advisable to wait at least four hours before connecting the appliance to allow the oil to flow back in the compressor.
- Adequate air circulation should be around the appliance, lacking this leads to overheating. To achieve sufficient ventilation follow the instructions relevant to installation.
- Wherever possible the back of the product should be against a wall to avoid touching or catching warm parts (compressor, condenser) to prevent possible burn.
- The appliance must not be located close to radiators or cookers.
- Make sure that the mains plug is accessible after the installation of the appliance.
- Connect to potable water supply only (If a water connection is foreseen).

### Service

- Any electrical work required to do the servicing of the appliance should be carried out by a qualified electrician or competent person.
- This product must be serviced by an authorized Service Centre, and only genuine spare parts must be used.

## Environment Protection

 This appliance does not contain gasses which could damage the ozone layer, in either its refrigerant circuit or insulation materials. The appliance shall not be discarded together with the urban refuse and rubbish. The

insulation foam contains flammable gases: the appliance shall be disposed according to the applicable regulations to obtain from your local authorities. Avoid damaging the cooling unit, especially at the rear near the heat exchanger. The materials used on this appliance marked by the symbol  are recyclable.

## Control panel

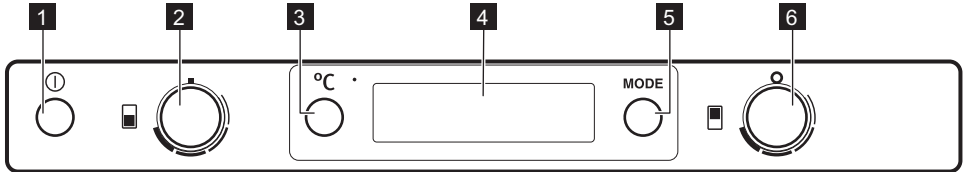

- 1** ON/OFF switch
- 2** Freezer temperature regulator
- 3** Fridge-Freezer temperature indication button
- 4** Display

- 5** Function button  
Alarm reset switch
  - 6** Fridge temperature regulator
- Display**

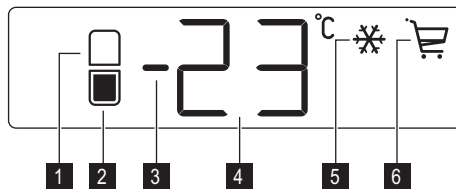

- 1** Fridge compartment indicator
- 2** Freezer compartment indicator
- 3** Positive or negative temperature indicator
- 4** Temperature indicator
- 5** Fast Freeze function
- 6** Shopping function

## Switching on

After plugging the plug into the power outlet, if the display is not illuminated, press ON/OFF switch.

As soon as the appliance is turned on, the following signals will appear on the control panel:

- Positive or negative temperature indicator will be positive, indicating that the temperature is positive
- the temperature flashes, the background of the display is red and you will hear a buzzer.

1) In normal conditions.

Press Function button and the buzzer will go off (also refer to "Excessive temperature alarm"). Set the desired temperature (refer to "Temperature regulation").

## Switching off

The appliance is shut off by pressing ON/OFF switch for more than 1 second.

After this, a countdown of the temperature from -3 -2 -1 will be shown.

When the appliance is switched off, Display also goes off.

## Temperature Indication

Each time the Fridge-Freezer temperature indication button is pressed, the display indicates in sequence:

1. – The Fridge compartment indicator is on.  
– The display indicates the fridge temperature.
2. – The Freezer compartment indicator is on.<sup>1)</sup>

– The display indicates the freezer temperature. In any case, after 10 seconds normal display conditions are restored.

## Functions menu

Each time Function button is pressed, the following functions are activated in a clockwise direction:

- Fast Freeze function
- Shopping function
- no symbol: normal operation.

**Important!** You can set one function ON at a time.

To set the functions OFF, press the Function button several times until no icon appears.

## Temperature regulation

The temperature within the appliance is controlled by the Temperature regulator situated at the top of the appliance. The temperature of the fridge compartment may be regulated by rotating the Fridge temperature regulator, and may vary between more or less +2°C and +8°C.

The temperature of the freezer compartment may be regulated by rotating the Freezer temperature regulator, and may vary between more or less -15°C and -24°C.

For a correct storage of the food the following temperatures should be set:

+5°C in the fridge

-18°C in the freezer.

During normal functioning the Temperature indicator shows the temperature currently set.

To operate the appliance, proceed as follows:

- turn the Temperature regulator clockwise to obtain the maximum coldness
- turn the Temperature regulator counter-clockwise to obtain the minimum coldness.

The intermediate position is usually the most suitable. However, the exact setting should be chosen keeping in mind that the temperature inside the appliance depends on:

- room temperature
- how often the door is opened
- the quantity of food stored
- the location of the appliance.

## Shopping Function

If you need to insert a large amount of warm food, for example after doing the grocery shopping, we suggest acti-

vating the Shopping function to chill the products more rapidly and to avoid warming the other food which is already in the refrigerator.

The Shopping function is activated by pressing Function button (several times if necessary) until the corresponding icon appears .

The Shopping function shuts off automatically after approximately 6 hours.

It is possible to deactivate the function at any time by pressing Function button (see "Activation of functions").

## Fast Freeze Function

To freeze fresh foods, you will need to activate the Fast Freeze function.

Press Function button (several times if necessary) until the corresponding icon appears.

This function stops automatically after 52 hours.

It is possible to deactivate the function at any time by pressing Function button (refer to "Functions Menu").

## Excessive temperature alarm

An increase in the temperature in the freezer compartment (for example due to a power failure) is indicated by:

- flashing temperature
- freezer compartment flashing (Freezer compartment indicator)
- red illumination of display
- sounding of buzzer
- alarm symbol.

When normal conditions are restored:

- the acoustic signal shuts off
- the temperature value continues to flash
- the display illumination remains red.

When you press Function button / Alarm reset switch to deactivate the alarm, the highest temperature reached in the compartment appears on indicator  for some seconds.

At this point the flashing stops and the display illumination changes over from red to white.

During the alarm phase, the buzzer can be switched off by pressing Function button / Alarm reset switch.

The illumination of the display remains red until normal storage conditions are restored.

## First use

### Cleaning the interior

Before using the appliance for the first time, wash the interior and all internal accessories with lukewarm water and some neutral soap so as to remove the typical smell of a brand-new product, then dry thoroughly.

## Daily use

### Freezing fresh food

The freezer compartment is suitable for freezing fresh food and storing frozen and deep-frozen food for a long time. To freeze fresh food activate the Fast Freeze function at least 24 hours before placing the food to be frozen in the freezer compartment.

Place the fresh food to be frozen in the third compartment. The maximum amount of food that can be frozen in 24 hours is specified on the **rating plate**, a label located on the inside of the appliance.

The freezing process lasts 24 hours: during this period do not add other food to be frozen.

### Storage of frozen food

When first starting-up or after a period out of use, before putting the products in the compartment let the appliance run at least 24 hours on the Fast Freezing setting.

If large quantities of food are to be stored, remove all drawers and baskets from appliance and place food on cooling shelves to obtain the best performance.

 **Warning!** Make sure that foods do not exceed the load limit stated on the side of the upper section

(where applicable) 

**Important!** In the event of accidental defrosting, for example due to a power failure, if the power has been off for longer than the value shown in the technical characteristics chart under "rising time", the defrosted food must be consumed quickly or cooked immediately and then re-frozen (after cooling).

### Thawing

Deep-frozen or frozen food, prior to being used, can be thawed in the refrigerator compartment or at room temperature, depending on the time available for this operation. Small pieces may even be cooked still frozen, directly from the freezer: in this case, cooking will take longer.

**Important!** Do not use detergents or abrasive powders, as these will damage the finish.

### Ice-cube production

This appliance is equipped with one or more trays for the production of ice-cubes. Fill these trays with water, then put them in the freezer compartment.

**Important!** Do not use metallic instruments to remove the trays from the freezer.

### Cold accumulators

The freezer contains at least one cold accumulator which increases storage time in the event of a power cut or breakdown.

### Movable shelves

The walls of the refrigerator are equipped with a series of runners so that the shelves can be positioned as desired.

For better use of space, the front half-shelves can lie over the rear ones.

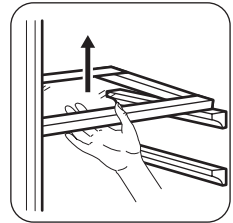

### Positioning the door shelves

To permit storage of food packages of various sizes, the door shelves can be placed at different heights.

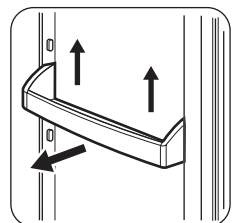
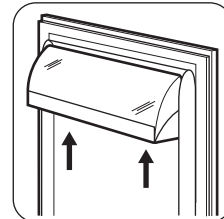

Gradually pull the shelf in the direction of the arrows until it comes free, then reposition as required.

## Helpful hints and tips

---

### Hints for energy saving

- Do not open the door frequently or leave it open longer than absolutely necessary.
- If the ambient temperature is high and the Temperature Regulator is set to low temperature and the appliance is fully loaded, the compressor may run continuously, causing frost or ice on the evaporator. If this happens, set the Temperature Regulator toward warmer settings to allow automatic defrosting and so a saving in electricity consumption.

### Hints for fresh food refrigeration

To obtain the best performance:

- do not store warm food or evaporating liquids in the refrigerator
- do cover or wrap the food, particularly if it has a strong flavour
- position food so that air can circulate freely around it

### Hints for refrigeration

Useful hints:

Meat (all types) : wrap in polythene bags and place on the glass shelf above the vegetable drawer.

For safety, store in this way only one or two days at the most.

Cooked foods, cold dishes, etc.: these should be covered and may be placed on any shelf.

Fruit and vegetables: these should be thoroughly cleaned and placed in the special drawer(s) provided.

Butter and cheese: these should be placed in special airtight containers or wrapped in aluminium foil or polythene bags to exclude as much air as possible.

Milk bottles: these should have a cap and should be stored in the bottle rack on the door.

Bananas, potatoes, onions and garlic, if not packed, must not be kept in the refrigerator.

### Hints for freezing

To help you make the most of the freezing process, here are some important hints:

## Care and cleaning

---

 **Caution!** Unplug the appliance before carrying out any maintenance operation.

- the maximum quantity of food which can be frozen in 24 hrs. is shown on the rating plate;
- the freezing process takes 24 hours. No further food to be frozen should be added during this period;
- only freeze top quality, fresh and thoroughly cleaned, foodstuffs;
- prepare food in small portions to enable it to be rapidly and completely frozen and to make it possible subsequently to thaw only the quantity required;
- wrap up the food in aluminium foil or polythene and make sure that the packages are airtight;
- do not allow fresh, unfrozen food to touch food which is already frozen, thus avoiding a rise in temperature of the latter;
- lean foods store better and longer than fatty ones; salt reduces the storage life of food;
- water ices, if consumed immediately after removal from the freezer compartment, can possibly cause the skin to be freeze burnt;
- it is advisable to show the freezing in date on each individual pack to enable you to keep tab of the storage time.

### Hints for storage of frozen food

To obtain the best performance from this appliance, you should:

- make sure that the commercially frozen foodstuffs were adequately stored by the retailer;
- be sure that frozen foodstuffs are transferred from the foodstore to the freezer in the shortest possible time;
- not open the door frequently or leave it open longer than absolutely necessary;
- once defrosted, food deteriorates rapidly and cannot be refrozen;
- do not exceed the storage period indicated by the food manufacturer.



This appliance contains hydrocarbons in its cooling unit; maintenance and recharging must therefore only be carried out by authorized technicians.

## Periodic cleaning

The equipment has to be cleaned regularly:

- clean the inside and accessories with lukewarm water and some neutral soap.
- regularly check the door seals and wipe clean to ensure they are clean and free from debris.
- rinse and dry thoroughly.

**Important!** Do not pull, move or damage any pipes and/or cables inside the cabinet.

Never use detergents, abrasive powders, highly perfumed cleaning products or wax polishes to clean the interior as this will damage the surface and leave a strong odour.

Clean the condenser (black grill) and the compressor at the back of the appliance with a brush. This operation will improve the performance of the appliance and save electricity consumption.

**Important!** Take care of not to damage the cooling system.

Many proprietary kitchen surface cleaners contain chemicals that can attack/damage the plastics used in this appliance. For this reason it is recommended that the outer casing of this appliance is only cleaned with warm water with a little washing-up liquid added.

After cleaning, reconnect the equipment to the mains supply.

## Defrosting the refrigerator

Frost is automatically eliminated from the evaporator of the refrigerator compartment every time the motor com-

pressor stops, during normal use. The defrost water drains out through a drain hole into a special container at the back of the appliance, over the motor compressor, where it evaporates.

## Defrosting of the freezer

The freezer compartment of this model, on the other hand, is a "no frost" type. This means that there is no buildup of frost when it is in operation, neither on the internal walls nor on the foods.

The absence of frost is due to the continuous circulation of cold air inside the compartment, driven by an automatically controlled fan.

## Periods of non-operation

When the appliance is not in use for long periods, take the following precautions:

- **disconnect the appliance from electricity supply**
  - remove all food
  - defrost (if foreseen) and clean the appliance and all accessories
  - leave the door/doors ajar to prevent unpleasant smells.
- If the cabinet will be kept on, ask somebody to check it once in a while to prevent the food inside from spoiling in case of a power failure.

## What to do if...

During operation of the appliance some smaller but annoying trouble can often occur, which does not require calling a technician out. In the following chart information is given about them to avoid unnecessary charges on service.

**Important!** The operation of the appliance goes with certain sounds (compressor and circulating sound). This not means a trouble, but a normal operation.

**Important!** The appliance operates discontinuously, so the stopping of compressor does not mean being no current. That is why you must not touch the electrical parts of the appliance before breaking the circuit.

Problem	Possible cause	Solution
The compressor operates continually	The Temperature Regulator may be set incorrectly	Set a warmer temperature



Problem	Possible cause	Solution
	The door does not close tightly or it is not shut properly	Check if the doors close well and the gaskets are undamaged and clean
	The door has been opened too frequently	Do not leave the door open longer than necessary
	Food placed in the appliance was too warm	Allow food to cool to room temperature before storing
	The temperature of the room that contains the appliance is too high for efficient operation	Try to reduce the temperature in the room where the appliance stands
<b>The lamp does not work.</b>	The lamp is in stand-by.	Close and open the door.
	The lamp is defective.	Refer to "Replacing the lamp".
<b>It is too warm in the refrigerator</b>	The Temperature Regulator may be set incorrectly	Set a lower temperature
	The door does not close tightly or it is not shut properly	Check if the door closes well and the gasket is undamaged and clean
	Food placed in the appliance was too warm	Allow food to cool to room temperature before storing
	Large quantities of food to be cooled were put in at the same time	Insert smaller quantities of food to be cooled at any one time
	There is no inside cool air circulation	Provide inside cool air circulation
<b>It is too cold in the refrigerator</b>	The Temperature Regulator may be set incorrectly	Set a higher temperature
<b>It is too warm in the freezer</b>	Temperature Regulator may be set incorrectly	Set a lower temperature
	The door does not close tightly or it is not shut properly	Check if the door closes well and the gasket is undamaged and clean
	Large quantities of food to be frozen were put in at the same time	Insert smaller quantities of food to be frozen at any one time.
	Food placed in the appliance was too warm	Allow food to cool to room temperature before storing.
	Products to be frozen are placed too closely to each other	Place the products in a way so that cold air could circulate among them
<b>It is too cold inside the freezer</b>	Temperature Regulator may be set incorrectly	Set a warmer temperature
<b>The appliance does not work at all. The appliance does not cool at all. Neither cooling nor lighting works</b>	The appliance may be switched off	Switch on the appliance

Problem	Possible cause	Solution
	Plug is not connected to the mains socket properly	Connect the mains plug properly
	Power does not reach the appliance	Try connecting another electrical device to the power outlet
	There is no voltage in the mains socket (try to connect another appliance into it)	Call an electrician

## Replacing the lamp

**⚠ Caution!** Disconnect the plug from the mains socket.

1. Press on the rear hook and at the same time slide the cover in the direction of the arrow.
2. Replace the lamp with one of the same power and specifically designed for household appliances. (the maximum power is shown on the light bulb cover).
3. Install the lamp cover by fixing it into its original position.
4. Connect the plug to the mains socket.
5. Open the door. Make sure that the light comes on.

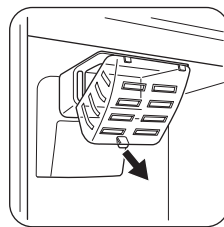

## Closing the door

1. Clean the door gaskets.
2. If necessary, adjust the door. Refer to "Installation".
3. If necessary, replace the defective door gaskets. Contact the Service Center.

## Technical data

Dimension of the recess		
	Height	1780 mm
	Width	560 mm
	Depth	560 mm
Rising Time		25 h
Voltage		230-240 V
Frequency		50 Hz

The technical information are situated in the rating plate on the internal left side of the appliance and in the energy label.

## Installation

**⚠ Caution!** Read the "Safety Information" carefully for your safety and correct operation of the appliance before installing the appliance.

## Positioning

Install this appliance at a location where the ambient temperature corresponds to the climate class indicated on the rating plate of the appliance:

Climate class	Ambient temperature
SN	+10°C to + 32°C
N	+16°C to + 32°C
ST	+16°C to + 38°C
T	+16°C to + 43°C

## Electrical Connection

**Caution!** Any electrical work required to install this appliance should be carried out by a qualified electrician or competent person.

**Warning!** This appliance must be earthed.  
The manufacturer declines any liability should these safety measures not be observed.

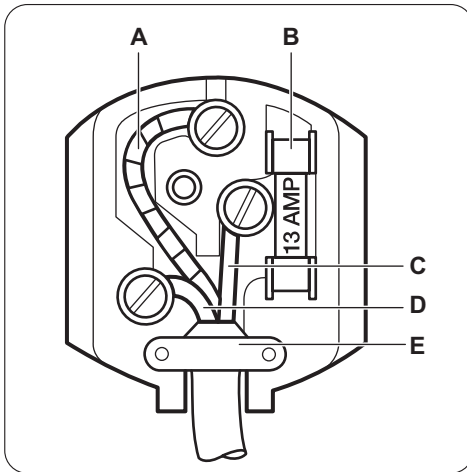

**Important!** The wires in the mains lead are coloured in accordance with the following code:

A	Green and Yellow:	Earth
C	Brown:	Live
D	Blue:	Neutral

As the colours of the wires in the mains lead of this appliance may not correspond with the coloured markings identifying the terminals in your plug, proceed as follows:

1. Connect the wire coloured green and yellow to the terminal marked either with the letter "E" or by the earth symbol  $\oplus$  or coloured green and yellow.
2. Connect the wire coloured blue to the terminal either marked with the letter "N" or coloured black.
3. Connect the wire coloured brown to the terminal either marked with the "L" or coloured red.
4. Check that no cut, or stray strands of wire is present and the cord clamp **E** is secure over the outer sheath.
5. Make sure the electricity supply voltage is the same as that indicated on the appliance rating plate.
6. Switch on the appliance.

The appliance is supplied with a 13 amp plug fitted **B**. In the event of having to change the fuse in the plug supplied, a 13 amp ASTA approved (BS 1362) fuse must be used.

**Warning!** A cut off plug inserted into a 13 amp socket is a serious safety (shock) hazard. Ensure that it is disposed of safely.

## Door reversibility

The door of the appliance opens to the right. If you want to open the door to the left, do these steps before you install the appliance:

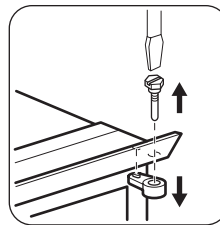

**1** Loosen the upper pin and remove the spacer.

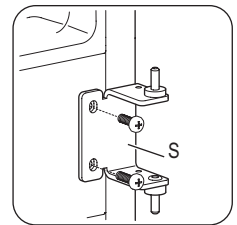

**2** Remove the upper pin and the upper door.

**3** Loosen the middle hinge.

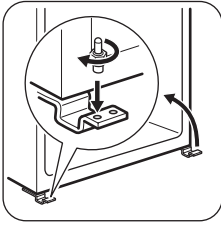

- ④ Remove the lower door.
- ④ Loosen the lower pin.

### Ventilation requirements

The airflow behind the appliance must be sufficient.

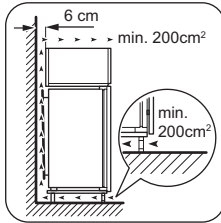

### Installing the appliance

**!** **Caution!** Make sure that the mains cable can move freely.

Do the following steps:

- On the opposite side:
- ① Install the lower pin.
  - ② Install the lower door.
  - ③ Tighten the middle hinge.
  - ④ Install the upper door.
  - ⑤ Tighten the spacer and the upper pin.

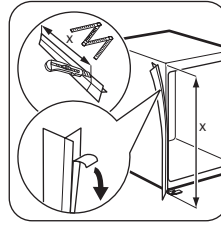

- ① If necessary cut the adhesive sealing strip and then apply it to the appliance as shown in figure.

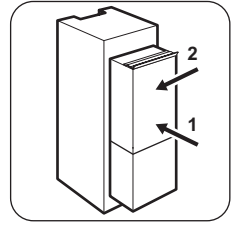

- ② Install the appliance in the niche. Push the appliance in the direction of the arrows (1) until the upper gap cover stops against the kitchen furniture. Push the appliance in the direction of the arrows (2) against the cupboard on the opposite side of the hinge.

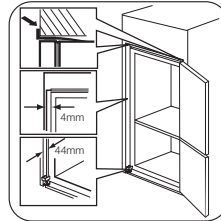

- ③ Adjust the appliance in the niche. Make sure that the distance between the appliance and the cupboard front-edge is 44 mm. The lower hinge cover (in the accessories bag) makes sure that the distance between the appliance and the kitchen furniture is correct. Open the door. Put the lower hinge cover in position.

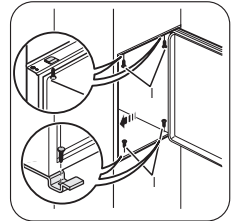

- ④ Attach the appliance to the niche with 4 screws.

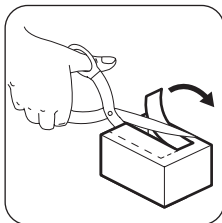

**5** Remove the correct part from the hinge cover (E). Make sure to remove the part DX, in the case of right hinge, SX in opposite case.

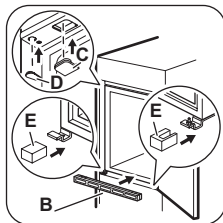

**6** Attach the covers (C, D) to the lugs and the hinge holes. Install the vent grille (B). Attach the hinge covers (E) to the hinge.

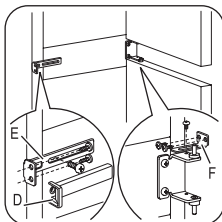

**7** Fix the appliance to the side of the kitchen unit, fit the bracket (E) and (F), adjust the distance, and fix using the screws (as in figure). Fit the cover (D).

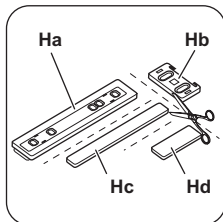

**8** Disconnect the parts (Ha), (Hb), (Hc) and (Hd).

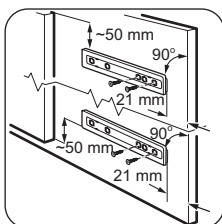

**9** Install the part (Ha) on the inner side of the kitchen furniture.

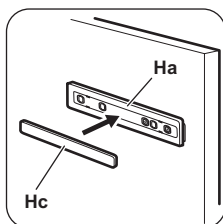

**10** Push the part (Hc) on the part (Ha).

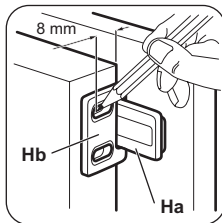

**11** Open the appliance door and the kitchen furniture door at an angle of 90°. Insert the small square (Hb) into guide (Ha). Put together the appliance door and the furniture door and mark the holes.

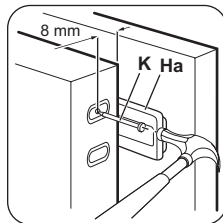

**12** Remove the brackets and mark a distance of 8 mm from the outer edge of the door where the nail must be fitted (K).

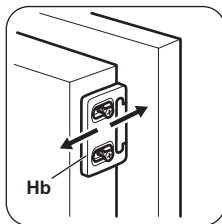

**13** Place the small square on the guide again and fix it with the screws supplied. Align the kitchen furniture door and the appliance door by adjusting the part Hb.

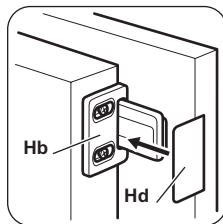

**14** Press the part (Hd) on the part (Hb).

Do a final check to make sure that:

- All screws are tightened.
- The magnetic sealing strip is attached tightly to the cabinet.

**Important!** If the ambient temperature is low (for example, in the Winter), the size of the gasket decreases. The size of the gasket increases when the ambient temperature increases.

## Environmental concerns

---

The symbol  on the product or on its packaging indicates that this product may not be treated as household waste. Instead it should be taken to the appropriate collection point for the recycling of electrical and electronic equipment. By ensuring this product is disposed of correctly, you will help prevent potential

negative consequences for the environment and human health, which could otherwise be caused by inappropriate waste handling of this product. For more detailed information about recycling of this product, please contact your local council, your household waste disposal service or the shop where you purchased the product.





[www.zanussi.com/shop](http://www.zanussi.com/shop)





## Free Manuals Download Website

<http://myh66.com>

<http://usermanuals.us>

<http://www.somanuals.com>

<http://www.4manuals.cc>

<http://www.manual-lib.com>

<http://www.404manual.com>

<http://www.luxmanual.com>

<http://aubethermostatmanual.com>

Golf course search by state

<http://golfingnear.com>

Email search by domain

<http://emailbydomain.com>

Auto manuals search

<http://auto.somanuals.com>

TV manuals search

<http://tv.somanuals.com>