

ZANUSSI

FREEZER ZBF 6114

INSTRUCTION BOOKLET

Important Safety Instructions

These warnings are provided in the interests of your safety. Ensure that you understand them all before installing or using this appliance. Your safety is of paramount importance. If you are unsure about any of the meanings of these warnings contact the Customer Care Department.

Prior to Installation

- Check the appliance for transport damage. Under no circumstance should a damaged appliance be installed. In the event of damage please contact your retailer.

Installation

- This appliance is heavy. Care should be taken when moving it.
- It is dangerous to alter the specifications or attempt to modify this product in any way.
- Ensure that the appliance does not stand on the electrical supply cable.
Important: if the supply cable is damaged, it must be replaced by a cable available from the manufacturer or your local Service Force Centre.
- Any electrical work required to install this appliance should be carried out by a qualified electrician or competent person.
- Parts which heat up should not be exposed. Whenever possible, the back of the appliance should be close to a wall, but leaving the required distance for ventilation, as stated in the installation instructions.
- The appliance should be left for 2 hours after installation before it is turned on, in order to allow the refrigerant to settle.

Refrigerant

- The refrigerant isobutane (R600a) is contained within the refrigerant circuit of the appliance, a natural gas with a high level of environmental compatibility, which is nevertheless flammable.
- During transportation and installation of the appliance, be certain that none of the components of the refrigerant circuit become damaged.
- If the refrigerant circuit should become damaged:
 - avoid open flames and sources of ignition.
 - thoroughly ventilate the room in which the appliance is situated.

Child Safety

- Do not allow children to tamper with the controls or play with the product.
- There is a risk of suffocation! Keep packaging material away from children!

General Safety

- **This appliance contains hydrocarbons in its cooling unit; maintenance and recharging must therefore only be carried out by authorised technicians.**
- **Take utmost care when handling your appliance so as not to cause any damages to the cooling unit with consequent possible fluid leakages.**
- **The appliance must not be located close to radiators or boilers.**
- **Avoid prolonged exposure of the appliance to direct sunlight.**
- **Do not use other electrical appliances (such as ice cream makers) inside of refrigerating appliances.**

During Use

- This appliance is designed for domestic use only, specifically for the storage of edible foodstuffs. It is not intended for commercial or industrial use.
- Containers with flammable gases or liquids can leak at low temperatures. Do not store any containers with flammable materials, such as spray cans, fire extinguisher refill cartridges etc. in the freezer.
- Frozen food should not be refrozen once it has thawed out.
- Do not place carbonated or fizzy drinks in the freezer compartment.
- Ice lollies can cause 'frost/freezer burns' if consumed straight from the freezer.
- Do not remove items from the freezer compartment if your hands are damp/wet, as this could cause skin abrasions or frost/freezer burns.
- Bottles and cans must not be placed in the freezer as they can burst when the contents freeze.
- Manufacturers' recommended storage times should be adhered to. Refer to relevant instructions.

Maintenance and Cleaning

- Before cleaning, always switch off the appliance and disconnect from the electrical supply.
- When unplugging always pull the plug from the mains socket, do not pull on the cable.

Servicing

- This product should be serviced by an authorised engineer and only genuine spare parts should be used.
- Under no circumstances should you attempt to repair the appliance yourself. Repairs carried out by inexperienced persons may cause injury or serious malfunctioning. Contact your local Service Force Centre.

At the end of the Appliance Life

- When disposing of your appliance use an authorised disposal site.

The symbol  on the product or on its packaging indicates that this product may not be treated as household waste. Instead it shall be handed over to the applicable collection point for the recycling of electrical and electronic equipment. By ensuring this product is disposed of correctly, you will help prevent potential negative consequences for the environment and human health, which could otherwise be caused by inappropriate waste handling of this product. For more detailed information about recycling of this product, please contact your local city office, your household waste disposal service or the shop where you purchased the product.

- Remove the plug and ensure that any locks or catches are removed, to prevent young children being trapped inside.

Contents

Instructions for the User

Important Safety Instructions	2
Operation	4
Before use	4
Freezer controls	4
Starting your appliance	4
Temperature control	4
Quick-freezing	4
Warning light (red)	5
Temperature acoustic alarm	5
Freezing fresh food	5
Frozen food storage	5
Freezing calendar	6
Thawing	6
Making ice cubes	6
Normal operating sounds	6
Health and Safety Guidelines	7
Defrosting	8
Maintenance and Cleaning	9
Internal cleaning / Changing the light bulb	9
Something Not Working?	10
Service and Spare Parts	11
Customer Care Department	11
Guarantee Conditions	12

Instructions for the Installer

Technical specifications	13
Installation	13
Positioning	13
Door reversal	14
Electrical Connection	15
Building in	16

Operation

Before use

Remove all securing tapes. Wash inside the appliance with lukewarm water and bicarbonate of soda (5 ml to 0.5 litre of water). Do not use soap or detergent as the smell may linger. Dry thoroughly.

Freezer controls

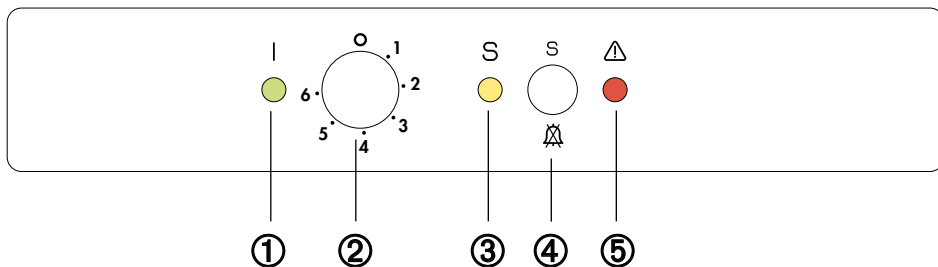

- 1 Pilot light (green)
- 2 Thermostat control knob
- 3 Fast-freezing indicator light (yellow)
- 4 Push button for fast-freezing and for stopping the audible signal (warning light on)
- 5 Warning light (red)

Starting your appliance

Insert the plug into the wall socket.

The appliance can be activated by turning the thermostat knob (2) beyond the «O» position. When the pilot light (1) is illuminated and a sound is on only for 2 sec. this shows that the appliance is on.

Push the button (4), the sound signal alarm will get off and pushing the button a second time the super control light (3) light up. The freezer will start to operate.

The freezer is switched off by turning knob (2) to position «O» and a sound is on only for 2 sec.

Temperature control

The temperature inside the freezer is regulated by a thermostat with different temperature positions and one «OFF» (O) position.

Position «1» = minimum cold

Position «6» = maximum cold

Turn the thermostat dial to the required position.

An intermediate position is usually the most suitable, although the temperature will be affected by:

- Room temperature
- How often the door is opened
- How much food is stored
- Position of the appliance

In determining the correct temperature control setting

all these factors have to be considered and some experimentation may be necessary.

To obtain a lower temperature, turn the thermostat control to the higher numbers; to obtain a higher temperature turn the control to the lower numbers.

When altering the temperature setting, allow 24 hours for the temperature to stabilise before making further changes.

Quick freezing

For quick-freezing, push the button (4). The super control light (3) will then light up.

If the quick-freezing function is not ended manually, the appliance switch off the quick-freezing function after 52 hours. The yellow light goes out.

The quick-freezing function can be ended manually at any time by pressing the button (4) again. The yellow light goes out.

Warning light (red)

If the temperature warning light (5) lights up, it indicates that the temperature within the freezer has reached a level where safe food storage is no longer ensured (warmer than -12°C).

When the freezer is first switched on, the warning light will stay on until the temperature has dropped to a safe level for the storage of frozen food.

Temperature acoustic alarm

This appliance incorporates an alarm which gives off an audible signal whenever the warning light comes on. This signal can be temporarily stopped by depressing the push button for fast-freezing (4). The fast-freezing push button can be released as soon as the warning light is off.

Freezing fresh food

In any 24 hour period you can freeze up to 16 kg of fresh food.

Activate fast freeze by depressing the fast-freeze button (1) 24 hours before you want to freeze your fresh food, the yellow light (2) illuminates. This time can be shortened, depending on the quantity of food to be frozen.

After the time has elapsed place the food to be frozen in the appliance's two top compartments; if freezing only a small amount of food, use the top compartment.

In the top compartment, products must only be stacked up to the mark on the cabinet interior so as to ensure that air circulation is not obstructed.

You should never freeze more than 16 kg of fresh food at anyone time.

Once the food is completely frozen (which could take up to 24 hours) the fast freeze function can be ended at any time by depressing the button (4) again. The yellow light (3) goes out.

Distribute the frozen food packages in the other compartments, so that the top compartments can be used for a further freezing operation.

Only freeze top quality, fresh and thoroughly cleaned foodstuffs.

Do not allow fresh food to touch food which is already frozen.

During the freezing process, ensure that the freezer door remains closed.

Frozen food storage

When you first start the freezer or if the freezer has been out of use for some time, we advise you to run your appliance for at least two hours in the «fast freeze» mode before storing frozen food.

To obtain the best performance from this appliance, we strongly recommend that you make sure that the commercially frozen foodstuffs were adequately stored by the retailer and, furthermore, be sure that these frozen foodstuffs are transferred from the foodstore to the consumer in the shortest possible time (a temperature increase of the frozen food could shorten its storage period).

It is also advisable not to exceed the storage period indicated by the producer of the food.

Finally, do not open the door frequently or leave it open longer than is absolutely necessary.



Important

Do not put carbonated liquids, (fizzy drinks etc.), in the freezer compartment.

Ice lollies, if consumed immediately after removal from the freezer, can possibly result in a low temperature skin burn.

Do not remove items from the freezer if your hands are damp/wet, as this could cause skin abrasions or "frost/freezer burns".

If there is a power failure during the storage of frozen food, do not open the door during the whole time of the power failure. If the freezer is fully loaded, the frozen food will not be affected if the power cut is of short duration; otherwise, it is recommended to consume the food within a very short time.

To remove the drawers, proceed as follows: pull the drawer out until it comes to a stop, then tilt it upwards (see figure).

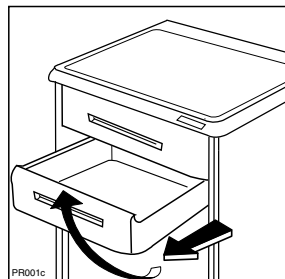

Freezing calendar

The symbols on the drawers show different types of frozen goods.

The numbers indicate storage times in months for the appropriate types of frozen goods. Whether the upper or lower value of the indicated storage time is valid depends on the quality of the foods and pre-treating before freezing.

Thawing

Frozen food, prior to being used, can be thawed in the fridge or at room temperature depending on the time available. Small food items may even be cooked from frozen; in this case cooking will take longer. Any frozen food which is allowed to thaw accidentally should either be eaten as soon as possible or thrown away. Alternatively, if the food is uncooked and has not been completely defrosted it can be cooked and then refrozen.

Defrosted cooked food must never be refrozen.

Making ice cubes

The appliance is provided with a plastic ice cube tray. Fill the tray 3/4 full to allow the ice to expand and place it in the freezer. To turn out the ice cubes simply give the tray a slight twist to release the cubes.

Never try to free an ice tray that is frozen to the freezer using a sharp or pointed object.

Normal Operating Sounds

You may hear faint gurgling or bubbling sounds when the refrigerant is pumped through the coils or tubing at the rear, to the fixed freezer shelves.

When the compressor is on, the refrigerant is being pumped round, and you will hear a whirring sound or pulsating noise from the compressor.

A thermostat controls the compressor, and you will hear a faint 'click' when the thermostat cuts in and out.

Health and Safety Guidelines

Because of consumer demand, preservatives have been removed from many pre-prepared foods. This together with the changes in shopping habits to a once-a-week shop, mean that safe handling and storage of food is even more important than ever.

The following tips should help you to ensure that the food in your home is in as perfect condition as possible.

- Keep the freezer door closed as much as possible.
- Do not push food together too much, try to allow air to circulate around each item.
- Cool cooked food as quickly as possible but do NOT place in the freezer until cool. (Leave food in a place as cool as possible in order that it can then be placed in the refrigerator as soon as possible).
- Do not store food uncovered.
- The best way to defrost food is to put it in the refrigerator to thaw slowly.
- Ensure that food placed in the freezer is dated and labelled and used in date order to ensure that food is consumed at its best.
- It is important that food is used before its "best before" date.
- Always wash your hands with soapy water and dry them with a clean towel before handling food.
- Keep work surfaces clean and avoid cross contamination by not using the same work surface or knife, without washing them thoroughly in between.
- The foods to be frozen must be fresh and of the best quality.
- The size of each pack should be small enough to ensure that it is used in one go. Small packs freeze more quickly and uniformly and give better results.
- Frozen food, once thawed, must not be refrozen. Lean food keeps better and longer than fatty food, salt reduces the storage time.
- Wrap the food in polythene or aluminium freezing bags or foil so that they adhere to the food and provide an airtight seal.
- Packaging which is swollen or has traces of refrozen water droplets on the pack could indicate that the product has not been kept at a suitable temperature and that it may have lost its original quality. Partially thawed food must not be refrozen, it must be consumed within 24 hours. Never exceed the storage time indicated.
- Never place hot food, bottles or cans of fizzy drink in the freezer as they may explode. Containers with a lid must not be filled to the brim.
- Do not open the door or place extra fresh food in the freezer next to food which is already frozen as this could cause the temperature of the frozen food to rise and its quality and storage life to reduce.



Important

In the event of a power failure causing the temperature within your freezer to rise, do not re-freeze the food without checking its condition. The following guidelines should assist you:

Ice-cream: once thawed should be discarded.

Fruits & Vegetables: if soft should be cooked and used up.

Breads & Cakes: can be re-frozen without danger.

Shellfish: should be refrigerated and used up quickly.

Cooked Dishes: i.e. casseroles should be refrigerated and used up.

Large Pieces of Meat: can be re-frozen providing there are still ice crystals remaining within them.

Small Joints: should be cooked and can then be re-frozen as cooked dishes.

Chicken: should also be cooked and re-frozen as a cooked dish.

Defrosting

The freezer compartment will become progressively covered with frost. This should be removed with the special plastic scraper provided, whenever the thickness of the frost exceeds 1/4".

During this operation it is not necessary to switch off the power supply or to remove the foodstuffs. However, when the ice becomes very thick on the inner liner, complete defrosting should be carried out and it is advisable to carry out this operation when the appliance is empty.

To carry out complete defrosting proceed as follows:

1. Remove any stored food, wrap it in several layers of newspaper and put it in a cool place.
2. Turn the thermostat control knob (2) to the «O» setting.
3. Leave the door open and introduce the plastic scraper in the appropriate seating at the base of the cabinet as shown in the figure and place a basin underneath to collect the defrost water.
4. When defrosting is completed, dry the interior thoroughly.

Keep the scraper for future use.

Turn the thermostat control knob to a medium setting and, after letting the appliance run for at least two hours in the «fast freeze» mode, replace the previously removed food into the compartments.

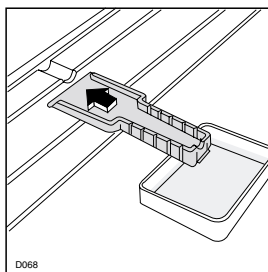

Important

A temperature rise of the frozen food packs during defrosting may shorten their storage life.

Never use sharp metal tools to scrape off frost from the evaporator as you could damage the appliance beyond repair.

Maintenance and Cleaning



Warning

Before any maintenance or cleaning work is carried out, **DISCONNECT** the appliance from the **ELECTRICITY** supply.



Important

This appliance contains hydrocarbons in its cooling unit maintenance and recharging must therefore only be carried out by authorised technicians.

Internal cleaning

Clean the inside and accessories with warm water and bicarbonate of soda (5ml to 0.5 litre of water). Rinse and dry thoroughly.

NEVER USE DETERGENTS, ABRASIVE POWDERS, HIGHLY PERFUMED CLEANING PRODUCTS OR WAX POLISHES, TO CLEAN THE INTERIOR AS THESE WILL DAMAGE THE SURFACE AND LEAVE A STRONG SMELL.



Important

Do not use abrasive products.

Once or twice a year remove the ventilation grill and dust the air channels at the base of the appliance with a brush or vacuum cleaner.

You **MUST** ensure that the appliance is switched **OFF**. An accumulation of dust will affect the performance of the appliance and cause excessive electricity consumption.

When the appliance is not in use

When the appliance is not in use for long periods, disconnect from the electricity supply, empty all foods and clean the appliance, leaving the door ajar to prevent unpleasant smells.

Something not Working?

Before contacting your local Service Force Centre check the following points.

IMPORTANT: If you call out an engineer to a fault listed below, or to repair a fault caused by incorrect use or installation, a charge will be made even if the appliance is under guarantee.

Symptom	Solution
No power to appliance	<ul style="list-style-type: none"> - Check there is power at the socket. - Check there is not a power cut by checking the household lights. - Check the fuse has not blown.
The temperature in the freezer is too high	<ul style="list-style-type: none"> - Check the thermostat control knob is turned to the correct setting relative to ambient conditions. - Check the ambient temperature is within the appliances operating limits of 10°C to 38°C. - Relocate the appliance if necessary.
The freezer door will not open	<ul style="list-style-type: none"> - Has door just been opened? If so leave for a few minutes to allow the air pressure to equalise.
The compressor runs continuously	<ul style="list-style-type: none"> - Adjust the thermostat control knob to give correct temperature control. See page 4. - Check that the door is closed. - Large quantities of food have recently been placed in the cabinet and/or door is frequently opened. - Check that air ventilation is not obstructed.
Excessive frost and ice has built up.	<ul style="list-style-type: none"> - Ensure the door is not left open. - Check that nothing is preventing the door from closing. - Is the door gasket intact and clean? - Has advised periodic defrosting been carried out?
Noise	<ul style="list-style-type: none"> - Refer to normal operating sounds.

If after the above checks, there is still a fault, call your local Service Force Centre.

In-guarantee customers should ensure that the above checks have been made as the engineer will make a charge if the fault is not a mechanical or electrical breakdown.

Please note that proof of purchase is required for any in-guarantee service calls.

Service and Spare Parts

SERVICE FORCE

In the event of your appliance requiring service, or if you wish to purchase spare parts, please contact your local Service Force Centre by telephoning:-

08705 929929

Your telephone call will be automatically routed to the Service Force Centre covering your post code area.

For the address of your local Service Force Centre and further information about Service Force, please visit the website at www.serviceforce.co.uk

Before calling out an engineer, please ensure you have read the details under the heading "Something Not Working."

When you contact the Service Force Centre you will need to give the following details:

1. Your name, address and post code
2. Your telephone number
3. Clear and concise details of the fault
4. The model and serial number of the appliance (found on the rating plate)
5. The purchase date

Please note that a valid purchase receipt or guarantee documentation is required for in-guarantee service calls.

For Customer Service in Ireland please contact us at the address below:

Zanussi
Electrolux Group (Irl) Ltd
Long Mile Road
Dublin 12
Republic of Ireland

Tel: + 353 1 4090751

Email: service.eid@electrolux.ie

Customer Care Department

For general enquiries concerning your Zanussi appliance or for further information on Zanussi products, please contact our Customer Care Department by letter or telephone at the address below or visit our website at www.zanussi.co.uk

Customer Care Department

Major Appliances

Zanussi

Addington Way

Luton

Bedfordshire

LU4 9QQ

Tel: 08705 727 727 (*)

* calls to this number may be recorded for training purposes.

Guarantee Conditions

Standard guarantee conditions

We, Zanussi, undertake that if within 24 months of the date of purchase this Zanussi appliance or any part thereof is proved to be defective by reason only of faulty workmanship or materials, we will, at our option repair or replace the same FREE OF CHARGE for labour, materials or carriage on condition that:

- The appliance has been correctly installed and used only on the electricity supply stated on the rating plate.
- The appliance has been used for normal domestic purposes only, and in accordance with the manufacturer's instructions.
- The appliance has not been serviced, maintained repaired, taken apart or tampered with by any person not authorised by us.
- All service work under this guarantee must be undertaken by a Service Force Centre.
- Any appliance or defective part replaced shall become the Company's property.
- This guarantee is in addition to your statutory and other legal rights.

Home visits are made between **8.30am** and **5.30pm** Monday to Friday. Visits may be available outside these hours in which case a **premium** will be charged.

Exclusions

This guarantee does not cover:

- Damage or calls resulting from transportation, improper use or neglect, the replacement of any light bulbs or removable parts of glass or plastic.
- Costs incurred for calls to put right an appliance which is improperly installed or calls to appliances outside the United Kingdom.
- Appliances found to be in use within a commercial environment, plus those which are subject to rental agreements.
- Products of Zanussi manufacture which are not marketed by Zanussi.

European Guarantee

If you should move to another country within Europe then your guarantee moves with you to your new home subject to the following qualifications:

- The guarantee starts from the date you first purchased your product.
- The guarantee is for the same period and to the same extent for labour and parts as exists in the new country of use for this brand or range of products.
- This guarantee relates to you and cannot be transferred to another user.
- Your new home is within European Community (EC) or European Free Trade Area.
- The product is installed and used in accordance with our instructions and is only used domestically, i.e. a normal household.
- The product is installed taking into account regulations in your new country.

Before you move please contact your nearest Customer Care centre, listed below, to give them details of your new home. They will then ensure that the local Service Organisation is aware of your move and able to look after you and your appliance.

France	Senlis	+33 (0) 3 44 62 29 29
Germany	Nürnberg	+49 (0) 800 234 7378
Italy	Pordenone	+39 (0) 0434 39 4700
Sweden	Stockholm	+46 (0) 8 672 53 90
UK	Luton	+ 44 (0) 8705 727727
Ireland	Dublin	+353 (0) 1 4090751

Technical specifications

POWER SUPPLY VOLTAGE AND FREQUENCY	_ 230-240 V / 50 Hz
TOTAL POWER ABSORBED	_ 0,8 A
AVERAGE DAILY UNITS ELECTRICITY(*)	_ 0,57 kWh
GROSS CAPACITY	110 l
NET CAPACITY	94 l
STAR RATING	XXXX

(*)This figure is based on standard test results in accordance with European Standard EN153 (Actual consumption will depend on how the appliance is used and where it is located).

Installation



Warning

IF YOU ARE DISCARDING AN OLD APPLIANCE THAT HAS A LOCK OR CATCH ON THE DOOR, YOU MUST ENSURE THAT IT IS MADE UNUSABLE TO PREVENT YOUNG CHILDREN BEING TRAPPED INSIDE.

Depending upon the position which you choose for your appliance, you may wish to reverse the way in which the door opens. To do this, refer to instructions under "Door reversal".

The appliance should be located in a dry atmosphere, out of direct sunlight and away from continuous heat and extreme temperature, e.g. not next to a boiler or radiator or in a very cold room e.g. an outhouse. If these temperatures are exceeded i.e. warmer or colder, then the appliance may not operate correctly.

For building-in and door reversal instructions please refer to the relevant instructions on the following pages.

Positioning

The appliance should only be installed at a location where the ambient temperature corresponds to the climate classification indicated on the rating plate, which is located on the inside left of the appliance. The following table shows which ambient temperature is correct for each climate classification:

SN	+10°C to +32°C
N	+16°C to +32°C
ST	+18°C to +38°C
T	+18°C to +43°C



Important

It **must** be possible to disconnect the appliance from the mains power supply; the plug must therefore be easily accessible after installation.

Door reversal

The appliance's door has been locked in position for transport by means of pins on both sides. According to the door opening direction, remove relevant pins at the top and at the bottom.



Attention

After completion of the door reversing operation, check that the door gasket adheres to the cabinet. If the ambient temperature is cold (i.e. in Winter), the gasket may not fit perfectly to the cabinet. In that case, wait for the natural fitting of the gasket or accelerate this process by heating up the part involved with a normal hairdryer on a low setting.

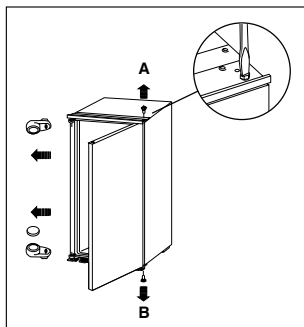

Electrical Connection



WARNING

THIS APPLIANCE MUST BE EARTHED.

The manufacturer declines any liability should this safety measure not be observed.

If the plug that is fitted to your appliance is not suitable for your socket outlet, it must be cut off and the appropriate plug fitted.

Remove the fuse from the cut off plug.

The cut off plug should then be disposed of to prevent the hazard of shocks in case it should be plugged into a 13amp socket in another part of your home.



Important

The wires in the mains lead are coloured in accordance with the following code:

Green and Yellow - Earth

Blue - Neutral

Brown - Live

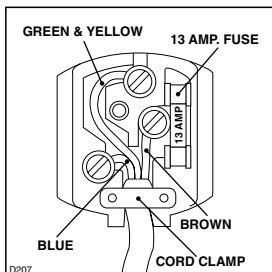

If you fit your own plug, the colours of the wires in the mains lead of your appliance, may not correspond with the markings identifying the terminals in your plug, proceed as follows:

Connect the Green and the Yellow (earth) wire to the terminal in the plug which is marked with the letter «E» or the earth symbol \oplus , or coloured green and yellow.

Connect the blue (neutral) wire to the terminal in the plug which is marked with the letter «N» or coloured black.

Connect the brown (live) wire to the terminal in the plug which is marked with the letter «L» or coloured red.

The plug moulded onto the lead incorporates a fuse. For replacement, use a 13amp BS1362 fuse. Only ASTA or BSI approved fuses should be used.

The plug must not be used if the fuse cover/carrier is lost. The cover/carrier is indicated by the coloured insert at the base of the plug.

This appliance complies with the following E.E.C. Directive:

- CE** -73/23 EEC of 19.2.73 (Low Voltage Directive) and subsequent amendments.
- 87/308 of 2.6.87 (Radio Interference Suppression) and subsequent amendments.
- 89/336 EEC of 3.5.89 (Electromagnetic Compatibility Directive) and subsequent amendments.

Please ensure that when the appliance is installed it is easily accessible for the engineer in the event of breakdown.

Building in

Dimensions of the recess

Height of housing (1) mm 880

Depth of housing (2) mm 550

Width of housing (3) mm 560

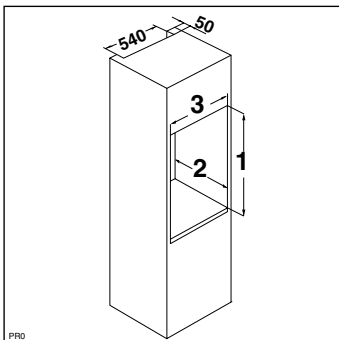

It is necessary that the cabinet has a ventilation recess with the following dimensions:

Depth 50 mm

Width 540 mm

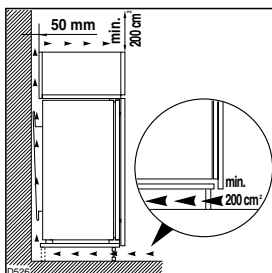

For appropriate venting, follow indications in the figure.

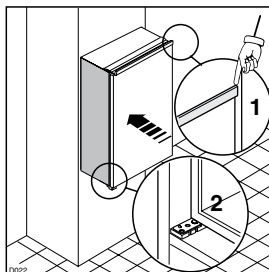

1. Fit the appliance in the niche by making sure that it stands against the interior surface of the unit on the side where the door hinges of the appliances are fitted. Insert the appliance until the upper strip butts up against the unit (1) and make sure that the lower hinge is in line with the surface of the unit (2).

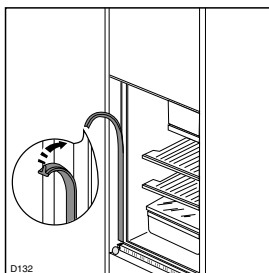

2. Press in the joint covers between the appliance and the kitchen furniture.

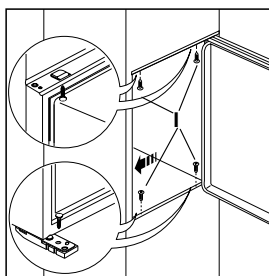

3. Open the door and push the appliance against the side of kitchen furniture opposite to that of the appliance hinges. Fasten the appliance with 4 screws (1) provided in the kit included with the appliance.

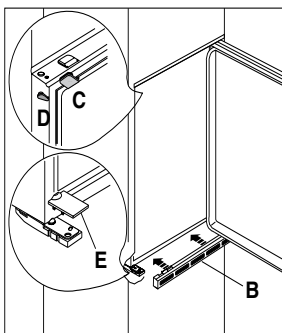

4. Snap vent grill (B) and hinge cover (E) into position.
Apply blanking covers (C-D) as indicated.

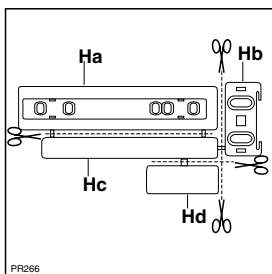

5. Separate parts Ha, Hb, Hc, Hd as shown in the figure.

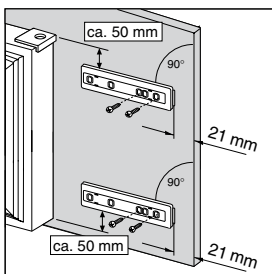

6. Place guide (Ha) on the inside part of the furniture door, up and down as shown in the figure and mark the position of external holes. After having drilled holes, fix the guide with the screws supplied.

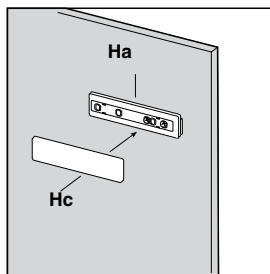

7. Fix cover (Hc) on guide (Ha) until it clips into place.

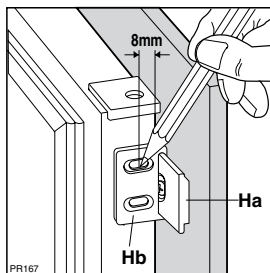

8. Open the appliance door and the furniture door at 90°. Insert the small square (Hb) into guide (Ha). Put together the appliance door and the furniture door and mark the holes as indicated in the figure.

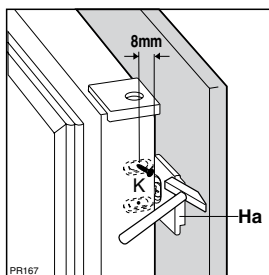

9. Remove the squares and mark a distance of 8 mm from the outer edge of the door where the nail must be fitted (K).

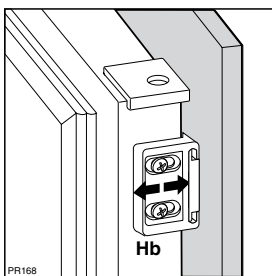

10. Place the small square on the guide again and fix it with the screws supplied.
Should the alignment of the furniture door be necessary, use the clearance of slots.
At the end of this procedure, it is necessary to check if the door of the furniture closes properly.

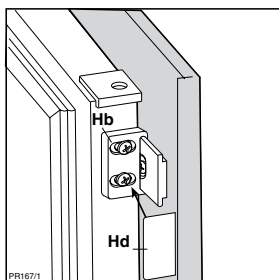

11. Fix cover (Hd) on the small square (Hb) until it clips into place.

© Electrolux plc 2007

 **From the Electrolux Group.** *The world's No.1 choice.*

The Electrolux Group is the world's largest producer of powered appliances for kitchen, cleaning and outdoor use. More than 55 million Electrolux Group products (such as refrigerators, cookers, washing machines, vacuum cleaners, chain saws and lawn mowers) are sold each year to a value of approx. USD 14 billion in more than 150 countries around the world.

Free Manuals Download Website

<http://myh66.com>

<http://usermanuals.us>

<http://www.somanuals.com>

<http://www.4manuals.cc>

<http://www.manual-lib.com>

<http://www.404manual.com>

<http://www.luxmanual.com>

<http://aubethermostatmanual.com>

Golf course search by state

<http://golfingnear.com>

Email search by domain

<http://emailbydomain.com>

Auto manuals search

<http://auto.somanuals.com>

TV manuals search

<http://tv.somanuals.com>