

Contents

For the user

Before using your microwave oven	29
Safety Instructions	30
Utensil safety	30
Testing suitability of cookware	30
Foil containers	31
Food safety	31
MAFF rating	31
Oven utensils and accessories guide	32
Description of the microwave oven and accessories	33
The microwave oven	33
Accessories	33
Control panel	34
Before using your microwave oven for the first time	
Cleaning	35
Setting the clock	35
General operating instructions	36
How to operate your microwave oven	38
Microwave cooking	38
Microwave setting guide	39
Minute timer with alarm	39
Automatic programmes	40
Auto Defrost	40
Quick Start	40
Manual defrosting	41
Automatic Cooking Programmes	42
Child Lock	43
Microwave Hints	43

Charts	
Defrosting	44
Cooking vegetables	46
Cooking fish	46
Care and cleaning	47
Cleaning the accessories	47
Cleaning the interior	47
Cleaning the exterior	47
Something Not Working	48
Service and Spare Parts	48
Customer Care	48
Guarantee Conditions	49
Standard guarantee conditions	49
Exclusions	49

For the installer

Installation	50
Electrical connections	50
Connecting to the mains	50
Build-In model	51
Technical data	51

Before using your microwave oven

Read through the instruction manual carefully. The following instructions have been prepared so that you get the best from your new Zanussi microwave oven. It is important that this instruction book is retained with the appliance for future reference. Should the appliance be sold or transferred to another owner, or if you move house and leave the appliance, always ensure that the book is supplied with the appliance so that the new owner can become acquainted with the functioning of the appliance and the relevant warnings. Please ensure you have read the whole instruction book before using the appliance and that you follow the recommendations given.

Unpacking

N.B. When you unpack the oven, check that the product is free from damage. Damage or any missing parts must be reported immediately to the retailer. The oven, parts of the oven or the accessories may be wrapped by a protection foil. If present, you must remove this foil before using the oven. Do not leave packing material where small children can play with it. This can be hazardous.

Safety instructions

- The built-in safety interlock switches prevent the microwave oven from operating when the door is open.
- Do not tamper with them, nor attempt to operate the oven with the door open, as open door operation can result in exposure to microwave energy.
- Do not allow food spills or cleaner residue to accumulate on door sealing surfaces. See the Cleaning and Care section for cleaning instructions.
- It is particularly important that the oven door closes properly and that there is no damage to the: (1) door (warped), (2) hinges and latches (broken or insecure), (3) door seals and sealing surface.



If the door, hinges/latches or door seals are damaged, the appliance must not be operated until it has been repaired by an authorized service engineer.



It is hazardous for anyone except factory trained service personnel to service or make adjustments to this oven. Contact your local Zanussi Service Force Centre if service should be required.

- Do not remove the outer case, door or control panel at any time. Doing so may cause exposure to extremely high voltage.
- Install or locate this oven only in accordance with 'installation instructions' found in this manual.
- Use the appliance for its intended use as described in this manual. Do not use corrosive chemicals in this appliance. This type of oven is specifically designed to heat, cook, or defrost food. **It is not designed for industrial, laboratory, nor commercial use, as this will invalidate the guarantee.**
- Do not operate the oven empty. If food or water is not present to absorb the microwave energy, the magnetron tube can be damaged.
- Do not store this appliance outdoors. Do not use this product near water.
- Do not attempt to dry clothing or newspapers in the microwave oven. These items can ignite.
- In order to evacuate moisture, your appliance is fitted with a delayed ventilation function. Depending on the applied cooking mode (solo / grill / combination), the oven ventilation will continue to operate after the cooking end. It switches off automatically after 3 minutes.

- Do not use the cavity for storage purposes. Do not leave paper products, cooking utensils, or food in the cavity when not in use.



If smoke is observed, switch off or unplug the appliance and keep the door closed in order to stifle any flames. **Never use water.**



Do not allow children to use the microwave without supervision until adequate instructions have been given so that the child is able to safely operate the microwave and understands the hazards of improper use.

Utensil safety

- Most glass, glass ceramic and heat-resistant glassware utensils are excellent for use in the microwave oven. Although microwave energy will not heat most glass and ceramic items, these utensils can become hot as heat transfers from the food to the container. Use oven gloves to remove dishes.

Testing suitability of cookware

- Place the cookware in the microwave along with a glass half full of water. Heat on 900W (100%) for one minute. If the cookware feels hot, you should not use it. If it is just slightly warm, you can use it for reheating but not for cooking. If the dish is at room temperature, it is suitable for microwave cooking.
- Paper napkins, wax paper, paper towels, plates, cups, cartons, freezer wrap and cardboard are great convenience utensils. Always be sure containers are filled with food to absorb energy and thus avoid the possibility of overheating.
- Many plastic dishes, cups, freezer containers and plastic wraps may be used in the microwave oven. Follow manufacturer's instructions when using plastics in the oven. Avoid using plastic utensils with foods that have high fat or sugar content since these foods reach high temperatures and could melt some plastics.
- Do not leave the oven unattended when heating or cooking food in plastic, paper or other combustible containers.

- Metal containers and containers with metallic trim should not be used in the microwave oven, unless specifically recommended for microwave use.
- Containers with restricted openings, such as bottles, should not be used for microwave cooking.
- Use caution when removing a lid or cover from a dish to avoid steam burns.

Foil containers

Shallow foil containers may safely be used to reheat foods in your microwave oven providing the following rules are observed:

1. Foil containers should not be more than 3 cm (1¼") deep.
2. Foil lids must not be used.
3. The foil containers must be at least two-thirds full of food. Empty containers must never be used.
4. Foil containers should be used singly in the microwave oven and should not be allowed to touch the sides. If your oven has a metal turntable or cooking rack, the foil container should be placed on an upturned ovenproof plate.
5. Foil containers should never be re-used in the microwave oven.
6. If the microwave oven has been in use for 15 minutes or more, allow it to cool before using it again.
7. The container and turntable may become hot during use, take great care when removing either from the oven. It is advisable to use an oven cloth or glove when doing so.
8. Remember when using an aluminium foil container that the reheating or cooking times may be longer than those you are used to, always ensure that the food is piping hot before serving.

Food safety

- Do not heat food in a can in the microwave oven. Always remove the food to a suitable container.
- Do not use the appliance for deep fat frying, because the fat temperature cannot be controlled, and hazardous situations can result.
- Popcorn may be prepared in the microwave oven, but only in special packages or utensils designed specifically for this purpose. This cooking operation should never be left unattended.
- Pierce foods with non-porous skins or membranes to prevent steam build-up and bursting. Apples, potatoes, chicken livers, and egg yolks are examples of items that should be pierced.

- The contents of feeding bottles and baby food jars are to be stirred or shaken and the temperature is to be checked before consumption, in order to avoid burns.



When heating liquids, e.g. soups, sauces and beverages in your microwave oven, overheating the liquid beyond boiling point can occur without evidence of bubbling. This could result in a sudden boil over of the hot liquid. To prevent this possibility the following steps should be taken:

1. Avoid using straight-sided containers with narrow necks.
2. Do not overheat.
3. Stir the liquid before placing the container in the oven and again halfway through the heating time.
4. After heating, allow to stand in the oven for a short time, stirring again before carefully removing the container.



Some products such as whole eggs and sealed containers – for example, closed glass jars – may explode and should not be heated in this oven. Occasionally, poached eggs may explode during cooking. Always pierce the yolk, then cover and allow the standing time of one minute before removing cover.

Keep these instructions!

MAFF Rating (UK)

Explanation of the heating category label for microwave ovens and small packs of food (up to 500g/1lb, typical of ready meals for 1 or 2 people) as agreed by MAFF (the Ministry of Agriculture Fisheries and Food) in conjunction with food and Microwave Oven manufacturers.



Microwave Symbol

Power Rating in Watts

Heating Category

Always follow food manufacturers instructions when cooking ready meals.

Always ensure that food is piping hot before serving. N.B. The higher the power output and heating category of the microwave oven, the less heating time is required.

Oven utensils and accessories guide

A variety of utensils and materials may be used for cooking in your microwave oven. For your safety and to prevent damaging utensils and your oven choose appropriate utensils and materials for each cooking method. The list below is a general guide.

Material	Utensils	Defrosting	Heating	Cooking
Ceramic & Glass	Corning ware	YES	YES	YES
	Heat resistant glass ware	YES	YES	YES
	Glass ware with metal decoration	NO	NO	NO
	Lead crystal glass	NO	NO	NO
China	Without metal decoration	YES	YES	YES
Pottery		YES	YES	YES
Plastic	Microwave oven heat-proof wear	YES	YES	YES
	Plastic wrap	YES	YES	YES
Metal	Metal baking pan	NO	NO	NO
	Aluminium foil*	YES	YES	NO
Paper	Cups, plates, towels	YES	NO	NO
Waxed paper		YES	NO	NO
Wood		NO	NO	NO
Accessories	Turntable	YES	YES	YES
	Turntable support	YES	YES	YES
YES: Utensils and accessories to use		NO: Utensils and accessories to avoid		
*NOTE: Use aluminium foil only for shielding purposes, overuse may cause arcing.				

Description of the microwave oven and accessories

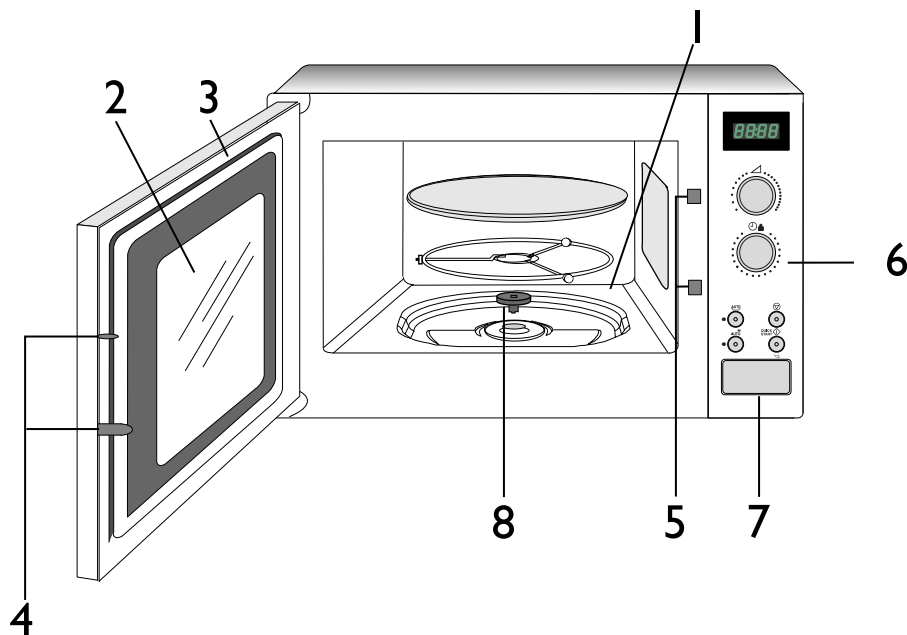

The microwave oven

- 1 Cooking compartment
- 2 Viewing window
- 3 Oven door
- 4 Door catch
- 5 Safety interlock system
- 6 Control panel
- 7 Door open button
- 8 Drive shaft for turntable

Accessories

Turntable and turntable support

The turntable and turntable support should be installed as shown in the diagram. Take care to ensure the turntable support is properly in place. The turntable may turn clockwise or counterclockwise during operation. Do not rotate the turntable manually, as you could damage the drive system.

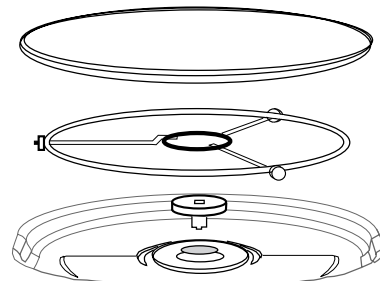

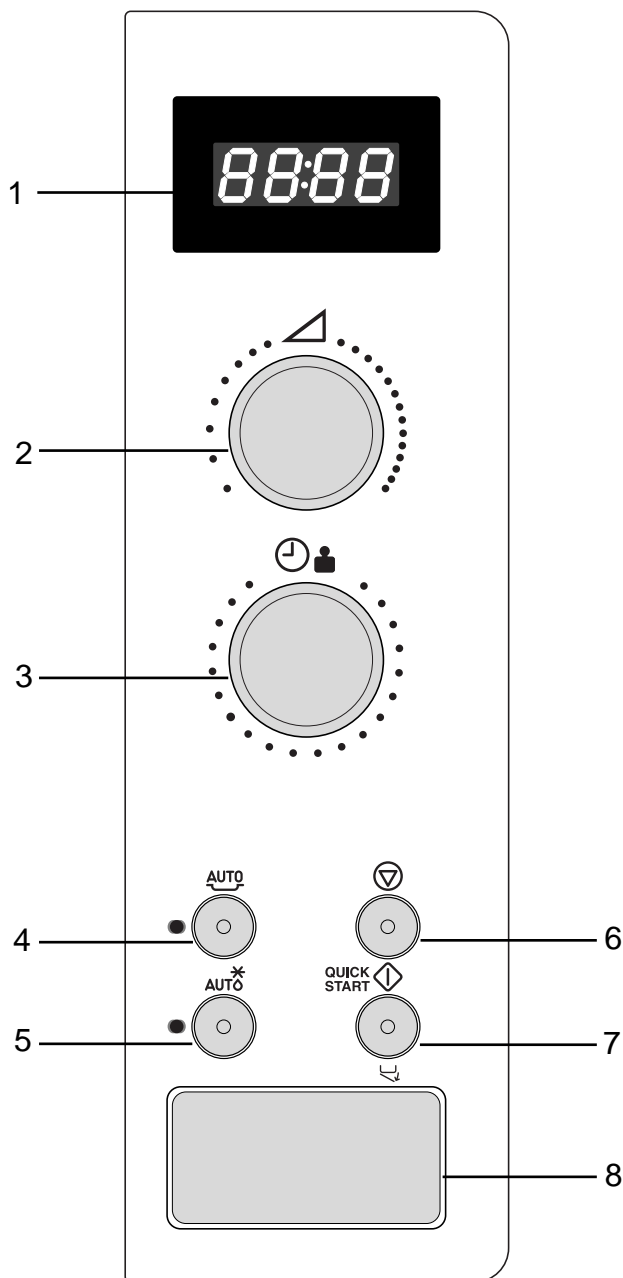

Control panel

1. **Display window** – shows time of day, cooking time and weight.
2. **Power control knob** – for setting desired microwave power level.
3. **Timer control knob** – to select cooking time or weight.
4. **Auto button** – for Automatic cooking programmes.
5. **Auto Defrost by weight.**
6. **Stop / Clear button** – to cancel or interrupt a cooking programme.
7. **Start button** – to start desired programme and to start the Quick start programme.
8. **Door open button**

Before using your microwave oven for the first time

Cleaning

Wipe over the front of the appliance with a damp cloth. Do not use abrasive cleaning agents (these can damage the surface). For stainless steel fronts use a suitable stainless steel cleaning agent that leaves a protective film against fingerprints.

Before you first use the appliance, remove all the accessories (including the turntable and turntable support) from the cooking area. Wash the accessories in warm water and washing up liquid. Wipe the cooking space with a soft, damp cloth.

Setting the clock

Plug the appliance into the mains. The display starts to flash "00:00".

The dots between the digits will flash rapidly.



Example: To set 12:15 :

Set the time of day with the Timer knob.



The dots between the digits flash slowly.

Confirm by pressing either the Start button or the Clear button.



The time of day is displayed.

12:15

The appliance is now ready for use.



The Timer knob can be turned clockwise (to increase) or counterclockwise (to decrease). The time of day can be changed at any time by pressing the Start for 5 seconds, turning the Timer knob and confirming with the Start or Clear button.

General operating instructions

Action	Comments
1. Press the door open button.	The door opens.
2. Place food in the cooking space.	
3. Shut the door.	An audible click will be heard when the door is shut. If the door is not shut properly the appliance will not function.
4. Select the cooking functions and time according to the instructions given in the following pages.	Turn the timer knob clockwise to increase and counter-clockwise to decrease time.
5. Press the Start button.	The appliance starts. The display shows the selected cooking time, and counts down in seconds.
6. End of cooking sequence.	The end of the cooking sequence is indicated by an audible tone. The appliance and the interior light will switch off. The time of day appears in the display.



If the oven is not started within 4 minutes, the settings are automatically cancelled and the time of day reappears in the display.



If you turn the timer knob clockwise past the maximum cooking time setting "50:00", the display shows "00:00".

Action	Comments
1. Interrupting the cooking process (e.g. for stirring): Open the door by pressing the door button.	The cooking operation stops. In the display, the two dots between the digits flash. The selected settings are unaffected.
2. Shut the door and press the Start button.	The countdown will continue.
3. Cancelling the programme : Press the Clear button.	The cooking process is cancelled. The appliance and the interior lighting switch off. The time of day is displayed.
4. Modifying the selected cooking time : Turn the Timer knob clockwise or counter-clockwise.	The cooking time in the display changes.
5. Modifying the selected microwave power: Rotate the Power control knob.	The new power setting is displayed for 5 seconds. The cooking process continues with the new power setting.



If the new selection is set at "00:00" in the display, the cooking time is over and an audible signal will be heard. The appliance and the interior lighting switch off. During a cooking process, the cooking time can be increased to a maximum of 60 minutes.

How to operate your microwave oven

Microwave cooking

This basic microwave cooking method allows you to cook food for a desired time. In addition to the maximum power level, you can select 9 different microwave power levels, between 80W and 900W.

Foods with high moisture content should be cooked on maximum power, as this is the fastest cooking method and best maintains the natural flavour and texture of the foods.

Example: To cook at 900W for 1 min 15 s:

1. Set the required microwave power by turning the Power control knob.
The time of day disappears from the display and the selected microwave power appears.

Turn to the left = lower power

Turn to the right = higher power



900

2. Set the required cooking time by turning the Timer knob. The chosen time appears in the display.



01:15

3. Press the Start button.
The selected time starts to count down.



01:14



Cooking time can be set as follows:

from 0 to 2 min. in 5 second steps

from 2 to 5 min. in 10 second steps

from 5 to 10 min. in 20 second steps

from 10 to 20 min. in 30 second steps

starting from 21 min. in 1-min. steps

Maximum programme length is 60 minutes.



Metal items must be kept at least 2 cm from the oven sides and the oven door.

Microwave setting guide

900W	– heating liquids
700W	– to start roast, stew, etc. – cooking vegetables – cooking dishes
600W	– defrosting and heating of deep frozen ready made meals
500W	– heating refrigerated ready made meals – finish cooking casseroles – cooking egg based dishes
450W	– finish cooking casseroles
350W	– cooking of delicate dishes
250W	– heating baby food in glass jar – soaking rice – heating delicate dishes – melting of gelatin
150W	– defrosting meat, fish and bread
80W	– defrosting cheese, cream and butter – defrosting cakes with cream or butter icing – to let dough rise – warming cold dishes, drinks, softening butter

Minute timer with alarm

The minute timer with alarm can also be used as a general purpose reminder. The timer works without selecting a cooking function.

How to set:

1. Select the microwave power " 0 " using the Power knob (all the way to the left).



2. Set the required time with the Timer knob. The time of day disappears from the display and the selected length of time appears.



3. Press the Start button. The pre-set time will start to count down. An audible signal will sound when the timer has finished counting down.



Automatic Programmes

Programmes for defrosting **AUTO*** and cooking **AUTO** are available. After having selected the programme, merely enter the weight of the dish, the rest of the programming is done automatically.

The following gives you an overview of which foods can be defrosted and cooked with which programme.

Auto Defrost

Progr.	Food categories	Examples	Weight from – up to
d 1	Poultry ¹	Poultry (whole or portions)	100 – 2000 g
d 2	Meat	Pork roast, Goulash	100 – 2000 g
d 3	Fish	Fish (whole or fillets)	100 – 1000 g
d 4	Delicate cakes and pastries	Cream pie	100 – 1000 g

¹ Cover legs and wings with aluminium foil before defrosting.



Unpack the frozen dish, place on top of a small overturned dish set inside a larger one to catch the liquid from defrosting. Follow our recommended standing time (general rule: standing time = defrosting time). A triple beep will sound halfway through defrost time. Turn or mix dish and, if possible, break up into pieces.

Quick Start

How to set

The Quick Start function provides full microwave power from 30 seconds up to 2 minutes and 30 seconds, in 30 second intervals.

Example: Heating a cup of water (1 min. 30 s) :





1. Press the Start/Quick button three times.
The time appears in the display and the appliance starts to operate.



01:30

2. You may increase the time by 30 second intervals while the programme is running up to a limit of 2 minutes and 30 seconds by pressing the Start/Quick button.

Example: To defrost a 1 kg chicken:

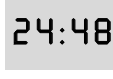
- | | | |
|---|---|--|
| 1. Press the button for Automatic Defrost until d1 appears in the display. |  |  |
| 2. Use the Timer/weight knob to set the weight. |  |  |
| 3. Press the Start button. The display shows the defrost time. |  |  |
| 4. If you want to modify the settings, press the Clear button and start again. | | |
-



Midway through the programme, three short beeps will be heard. Stir or turn the food item at this time. The programme is not interrupted.



Defrosting Tips

1. It is better to underestimate defrosting time if you are unsure. Food will continue to defrost during the standing time.
 2. Separate food into smaller pieces as soon as possible.
 3. Turn large items, e.g. joints, halfway through the defrosting time.
 4. Remove any thawed food as soon as possible.
 5. Remove or open any packaging before defrosting.
 6. Place food in a larger container than that which it was frozen in to allow for easy stirring.
 7. Begin thawing poultry breast side down and turn over halfway through defrosting time. Delicate areas such as wing tips can be shielded with small pieces of smooth foil.
 8. Standing time is very important, particularly for large, dense foods which cannot be stirred in order to ensure that the centre is completely defrosted before cooking.
-

Manual defrosting

For manual defrosting (without using Auto Defrost features) use 150W. To speed up the defrosting of dense foods over 450g (1lb), the oven may be started on full power for 1–3 minutes, then be reduced to 150W until defrosting is complete.

Automatic Cooking Programmes

Progr.	Food categories	Examples	Weight from – up to
	Fresh vegetables I	Brussels sprouts, cabagge, carrots, celeriac	100 – 1000 g
	Fresh vegetables II	Zucchini, leeks, potatoes, spinach, fennel, cauliflower, broccoli	100 – 1000 g
	Frozen vegetables	Carrots, cauliflower, Brussels sprouts, leeks, zucchini, spinach, broccoli	100 – 1000 g



Cook covered, in a heat-resistant glass dish, whenever possible. A triple beep rings halfway through cook time. If cooking over 500 g of vegetables, stir once or twice.

Please add water in the following amounts:

FRESH VEGETABLES (I + II)

100 - 500 g

500 - 1000 g

FROZEN VEGETABLES

100 - 500 g

500 - 1000 g

TABLESPOONS

3 - 6

9 - 12

TABLESPOONS

3 - 6

9 - 12

Example: To cook 500 g Fresh Vegetables I :

1. Press the button for Automatic Cooking programme until  appears in the display.





2. Use the Timer/weight knob to set the weight.





3. Press the Start button.
The display shows the time.





Child lock

This oven is equipped with a Child Lock Safety feature to prevent accidental operation by children.

How to set :

First press the Clear button **5 times**, then press the Start button. The display shows "LOC".



LOC

The safety lock prevents the oven from operating. There will be no effect if you turn either knob or any button.

How to cancel :

Press the Clear button **5 times**, then press the Start button. A beep will sound. The time of day will reappear in the display and the appliance will function normally.



Microwave Hints

- Always keep the oven clean – avoid spill-overs and do not forget to clean under the turntable and the inside of the door.
- It is preferable to use round or oval casseroles with a lid when cooking in your microwave oven.
- Do not use metal or metal decorated casserole dishes. Certain plastic materials can melt and be warped by hot food.
- Cover the food when cooking. Use a glass lid, a plate or grease proof paper.
- Pastry, bread and the like can be defrosted directly in a bread basket or on a paper towel.
- If frozen food is heated in its packaging, the packaging should be opened. Packaging containing metal or metal decoration must not be used unless specifically recommended for use in the microwave. Remove metal clips and wire ties.
- Smaller pieces of aluminium foil can be used to cover parts that easily overcook such as chicken legs.
- Food with peel or skin should be pierced with a fork – e.g. potatoes and sausages. Do not boil eggs in the microwave oven as they can explode.
- Put large, thick pieces close to the edge of the casserole and try to cut the food into even-sized pieces. Always place the food in the centre of the oven.
- The food will be more evenly cooked if you stir or turn it regularly.
- Always set a shorter cooking time than indicated in your recipe to avoid overcooking. The larger the amount of food the longer it takes.
- Use little or no water for vegetables.
- Use less salt and spices than for conventional cooking.
- Season afterwards.
- Allow a few minutes 'standing time' after the oven has switched off to ensure complete and even cooking results.
- Always ensure food is piping hot throughout before serving.
- Use gloves when taking dishes and food from the oven.

Charts

Defrosting

Dish	Weight (g)	Power (Watt)	Duration (min)	Standing time (min)	Remarks/Hints
Meat					
Whole meat	500	150	10–15	10–15	Turn once. Cover fatty parts with aluminium foil midway through.
Steak	200	150	4–6	5–10	Turn once.
Mixed chopped meat	500	150	9–14	5–10	Remove defrosted chopped meat midway through programme.
Poultry					
Chicken	1000	150	20–30	15–30	Turn once. Cover legs and wings with aluminium foil midway through.
Duck	1500	150	35–45	40–60	As for chicken.
	2000	150	50–60	40–60	
Fish					
Whole fish	500	150	10–15	15–20	Turn once. Cover fins with aluminium foil.
Shrimps/Crab	250	150	6–8	15–20	Stir thoroughly halfway through defrosting time.
Dairy produce					
Cottage cheese	500	150	15–20	15–20	Remove any aluminium foil wrapping. Divide and stir frozen pieces from time to time.
Butter	250	150	2–3	15–20	Remove any aluminium foil wrapping.
Cheese	250	150	2–4	20–30	Turn once.
Cream	200 ml	150	6–8	15–20	Remove any aluminium foil wrapping. Stir frozen pieces from time to time.
Fruit					
Strawberries	500	150	7–9	10–15	Defrost in a covered container, turn once.
Cherries	250	150	5–7	5–10	As for strawberries.
Black currants	250	150	5–7	10–15	As for strawberries.
Red currants	250	150	4–6	5–10	As for strawberries.
Raspberries					

Defrosting

Description	Weight (in g)	Power (Watt)	Duration (min)	Standing time (min)	Remarks/Hints
Bread					
Rolls (50 g)	4 units	150	1–3	3–5	Set on a paper towel, turn once.
Whole meal, mixed, rye loaf	1 slice (60–80 g) 500	150	15"–30"	3–5	Defrost in a covered container.
Pastry					
Dry cakes e.g. cakes with short crust pastry	300	80	2–3	5–10	Set on a paper towel, cover.
Fruit flans baked on a baking sheet	400–450	80	4–8	10–20	As for dry cakes.
1 slice cheese cake	400	80	4–8	10–20	As for dry cakes.
1 slice covered apple tart	400	80	3–5	10–20	As for dry cakes.
Cream and butter-cream layer cakes	300–400	80	2–4	10–20	Begin defrosting in the microwave, and finish defrosting at room temperature.
Melting food					
Chocolate/toppings	100	700	2–3		Break up into pieces, stir from time to time.
Butter	50	900	15"–45"		
Heating of refrigerated food and drink					
1 jar baby food	125–250	450	30"–50"	2–3	Heat jar without lid. Stir after warming. Check temperature.
1 ready meal on a plate	350–400	900	2–3	2–3	Heat in a covered container. Place gravy alongside in a cup.
1 portion of meat	150	900	45"–1'	2–3	All meat, except breaded meat, should be heated in a covered container.
1 portion vegetables, potatoes or rice	200	900	1'–1'30"	2–3	Heat in covered container, stir once.
1 cup soup	200 ml	900	1'20"–2'	2–3	Heat clear soup uncovered, cover thick soups. Stir.
Drinks					
Milk or baby food	200 ml	900	35"–45"	2–3	Remove any lids. Stir after warming !
Boil 1 cup water	180 ml	900	1'30"–2'	2–3	Stir instant coffee or tea when the water has stopped boiling.
1 cup milk	200 ml	900	1'50"–2'	2–3	Heat milk until it is just hot enough to drink. Stir.
1 cup coffee (reheat)	200 ml	900	45"–55"	2–3	Stir. Check temperature !

Description	Weight (g)	Power (Watt)	Duration (min)	Standing time (min)	Remarks/Hints
Defrosting and heating of frozen convenience foods					
1 portion meat with gravy	150	700	2–4	2–3	Heat in a covered container. Stir now and again.
1 portion meat with vegetables, garnish	350–450	700	7–14	2–3	As for meat with gravy.

Cooking vegetables

Cook all vegetables in a covered container.

Description	Weight (g)	Liquid added	Power (Watt)	Duration (min)	Standing time (min)	Remarks/Hints
Cauliflower	500	1/8 l	900	8–10	2	Dot with butter.
Frozen broccoli	300	1/8 l	900	7–9	2	Stalks facing outwards.
Mushrooms	250	none	900	4–6	2	Cut into slices.
Frozen peas and carrots	300	1/2 cup	900	7–9	2	
Carrots	250	2–3 tsp	900	6–8	2	Cut into cubes or slices.
Potatoes	250	2–3 tsp	900	4–6	2	Peel and quarter.
Red/Green peppers	250	none	900	4–6	2	Cut into cubes or slices.
Leeks	250	1/2 cup	900	4–6	2	Cut into rings or pieces.
Frozen Brussels Sprouts	300	1/2 cup	900	7–9	2	

l = litre

Cooking fish

Description	Weight (in g)	Power (Watt)	Duration (min)	Standing time (min)	Remarks/Hints
Fish fillets	500	500	6–8	2	Cook covered. Turn halfway through the cooking time.
Whole fish	800	1. 900	3–5	3	Cover during cooking.
		2. 450	9–11	3	Cover flat parts with aluminium foil.



The times stated here are for guidance only.

Care and cleaning

The oven must always be clean. Residue of food from spill-overs or splatters will absorb microwave energy causing it to burn on. This could reduce the efficiency of the oven and may cause unpleasant odours. Do not attempt to tamper with or make any adjustments or repairs to any part of the oven. Repairs should only be made by an authorised service engineer.



Always ensure that the oven is disconnected from the electricity supply before cleaning.

Cleaning the accessories

Clean them with mild detergent after removing them from the cavity. The turntable support should be carefully handled.



The inside of the oven and turntable get very hot, so do not touch them immediately after use.

Cleaning the interior

Soilage that is allowed to remain on the oven walls, door seal and door surface will absorb microwave energy, reduce the efficiency of the oven, and possibly damage the oven interior.

Use mild, liquid detergent, warm water and a soft, clean cloth to remove soilage. **NEVER USE ABRASIVE CLEANERS, COMMERCIAL OVEN CLEANERS OR STEEL WOOL PADS ON ANY PART OF THE MICROWAVE OVEN.**

To loosen difficult soilage, boil a cup of water in the microwave oven for 2 to 3 minutes. **NEVER USE A KNIFE OR ANY UTENSIL TO REMOVE SOILAGE FROM OVEN SURFACES.**

To remove odours from the oven interior, boil a cup of water containing 2 tablespoons of lemon juice for 5 minutes.

Cleaning the exterior

Open the oven door when cleaning the control panel. This will prevent the oven from being turned on accidentally. You should clean outside surfaces of the oven with mild liquid detergent and water, followed by a wiping with clear water to remove any excess detergent. Dry with a soft cloth.

Spray-on window cleaners or all purpose spray-on kitchen cleaners can also be used. Never use abrasive cleaners, scouring pads or harsh chemicals on outside surfaces of your oven. To prevent damage to the working parts, do not allow water to seep into the ventilation openings.

Something Not working

If the appliance does not function correctly, please carry out the following checks before contacting your local Service Force Centre.

If the oven does not come on:

- Check the appliance is connected correctly.
- Check that the oven is plugged in properly.
- Replace the fuse in the plug, if required, with another of the same rating and check that the plug has been wired correctly.
- Check that the socket switch and/or the switch from the mains supply to the oven are ON.
- Check that the socket is receiving power, by plugging in an appliance you know to be working.
- Check that the the fuse in the fuse box is intact.

If the microwave does not function:

- The child safety lock may have been set.
- Check the controls are set correctly.
- Check settings/procedures against the instruction booklet.
- Check the door closes properly (if food particles or other objects have become stuck inside the door, it will not close properly and microwave cooking will not take place).
- Check the start pad has been depressed.

IMPORTANT:

If you call out an engineer to a fault listed above, or to repair a fault caused by incorrect use or installation, a charge will be made even if the appliance is under guarantee.

Before calling out an engineer, please ensure you have made the above checks.

When you contact the Service Force Centre you will need to give the following details:

1. Your name, address and post code
2. Your telephone number
3. Clear and concise details of the fault
4. The model and serial number of the appliance (found on the rating plate)
5. The purchase date

We suggest you make a note below so you have the details to hand:

Model: ZM24 ST

Serial Number:

Date of Purchase:

In-guarantee customers should ensure the necessary checks have been made as the engineer will make a charge if the problem is not a mechanical or electrical breakdown.

Please note that proof of purchase will be required for in-guarantee calls.

Spare parts

Spare parts may be purchased through your local Service Centre.

Customer care

For general enquiries concerning your Zanussi appliance, or for further information on Zanussi products, please contact our Customer Care Department by letter or telephone.

Guarantee conditions

Standard guarantee conditions

We, Zanussi, undertake that if within 24 months of the date of the purchase this Zanussi appliance or any part thereof is proved to be defective by reason only of faulty workmanship or materials, we will, at our option repair or replace the same FREE OF CHARGE for labour, materials or carriage on condition that:

- The appliance has been correctly installed and used only on the electricity supply stated on the rating plate.
- The appliance has been used for normal domestic purposes only, and in accordance with the manufacturer's instructions.
- The appliance has not been serviced, maintained, repaired, taken apart or tampered with by any person not authorised by us.
- All service work under this guarantee must be undertaken by a Zanussi service centre.
- Any appliance or defective part replaced shall become the Company's property.
- This guarantee is in addition to your statutory and other legal rights.

Exclusions

This guarantee does not cover:

- Damage or calls resulting from transportation, improper use or neglect, the replacement of any light bulbs or removable parts of glass or plastic.
- Costs incurred for calls to put right machines improperly installed or calls to machines outside the United Kingdom.
- Appliances found to be in use within a commercial or similar environment, plus those which are subject to rental agreements.
- Products of Zanussi manufacture which are not marketed by Zanussi.

European Guarantee

If you should move to another country within Europe then your guarantee moves with you to your new home subject to the following qualifications:

- The guarantee starts from the date you first purchased your product.
- The guarantee is for the same period and to the same extent for labour and parts as exist in the new country of use for this brand or range of products.
- This guarantee relates to you and cannot be transferred to another user.
- Your new home is within the European Community (EC) or European Free Trade Area.
- The product is installed and used in accordance with our instructions and is only used domestically, i.e. a normal household.
The electrical supply complies with the specification given in the rating label.
- The product is installed taking into account regulations in your new country.

Before you move, please contact your nearest Customer Care centre, listed below, to give them details of your new home. They will then ensure that the local Service Organisation is aware of your move and able to look after you and your appliances.

France	Senlis	+33 (0)3 44 62 29 29
Germany	Nürnberg	+49 (0)800 234 7378
Italy	Pordenone	+39 (0)0434 39 4700
Sweden	Stockholm	+46 (0)8 672 53 90
UK	Slough	+44 (0)1753 219897

For the installer

1. Remove any promotion label from the door.
2. This oven can be used as a free standing oven or built-in, into a kitchen cabinet using kit number BF246, which is ordered separately. To install the oven in a kitchen cabinet follow the instructions supplied with the building-in kit.
The oven should be installed on a flat, level surface. The surface must be strong enough to safely bear the weight (18 kg) of the oven, and the contents. To avoid the possibility of causing vibration or noise the oven must be in a stable position.
3. Keep the oven away from heat and water. Exposure to heat and water can lower oven efficiency and lead to malfunctioning, so be sure to install the oven away from heat and water sources.
4. If using the appliance as a free-standing appliance do not block air vents on the top and the sides of the cabinet and also do not place any articles on the top of the oven. A gap all around the oven is necessary : 140 mm above the oven and any objects, 50 mm on the sides and 100 mm behind the oven. If air vents are blocked during operation the oven may overheat, and this may lead to malfunctioning. Hot air escapes from the vents, so be sure not to obstruct them or let curtains come between the oven and the rear wall.
5. Place the oven as far away from radios and TVs as possible. This oven does conform to EEC requirements of radio interference suppression, but some interference may occur if it is placed too close to a radio or TV, so keep them as far apart as possible.

Connecting to the mains

The oven is delivered with the power cord and a plug for 240 V, 50Hz, earthed socket outlet.

Earth protection minimizes the risks should a short-circuit occur. Check to ensure the voltage of the oven matches the supply.

N.B. If the oven is connected to the socket via an extension cord, make sure the cord is earthed.



This appliance must not be used on a non-earth protected power supply. Contact an electrician if you are uncertain regarding electrical connection of the oven or provision of earth protection of the supply.

This appliance must be earthed. If this appliance is fitted with a non-rewirable plug for which your socket is unsuitable, the plug should be cut off and the appropriate plug fitted. If it is necessary to change the fuse in a nonrewirable plug, the fuse cover must be refitted. If the fuse cover is lost or damaged, the plug must not be used until a replacement is obtained.

Electrical connections



THIS APPLIANCE MUST BE EARTHED.
The manufacturer declines any liability should this safety measure not be observed.

Build-in model

To install the appliance in a kitchen cabinet, use the appropriate mounting frame. Note the relevant instructions for installation and connection. When building in to a high cabinet, you may use the lift door. Note the relevant information for installation and connection given in the operating instructions of the lift door.

Warning !

Never operate the microwave oven with the lift door closed. Such operation would damage your appliance and invalidate the guarantee.

Connect to a plug socket with protective earth contact and fused with a 13 A-L automatic device or 13 A slow-blowing fuse. When the oven is installed, there must be a possibility of disconnecting it from mains with a contact break of at least 3 mm on all poles.

A suitable size of LS-switch, or a melting or fly-out fuse, are suitable contact-breakers.

Technical data

Building in kit		BF246	Power source	230-240 V, 50 Hz
Overall oven dimension	Width	540.5 mm	Fuse	16 A
	Depth	416.5 mm	Power consumption	1550 W
	Height	316 mm	Power Output	900 W
Cavity	Width	350 mm	Weight	18 kg
	Depth	351.4 mm		
	Height	210 mm		
Volume		24 l		



 **From the Electrolux Group.** *The world's No.1 choice.*

The Electrolux Group is the world's largest producer of powered appliances for kitchen, cleaning and outdoor use. More than 55 million Electrolux Group products (such as refrigerators, cookers, washing machines, vacuum cleaners, chain saws and lawn mowers) are sold each year to a value of approx. USD 14 billion in more than 150 countries around the world.

Free Manuals Download Website

<http://myh66.com>

<http://usermanuals.us>

<http://www.somanuals.com>

<http://www.4manuals.cc>

<http://www.manual-lib.com>

<http://www.404manual.com>

<http://www.luxmanual.com>

<http://aubethermostatmanual.com>

Golf course search by state

<http://golfingnear.com>

Email search by domain

<http://emailbydomain.com>

Auto manuals search

<http://auto.somanuals.com>

TV manuals search

<http://tv.somanuals.com>