

INSTRUCTION FOR THE USE AND CARE OF ZANUSSI MICROWAVE OVEN

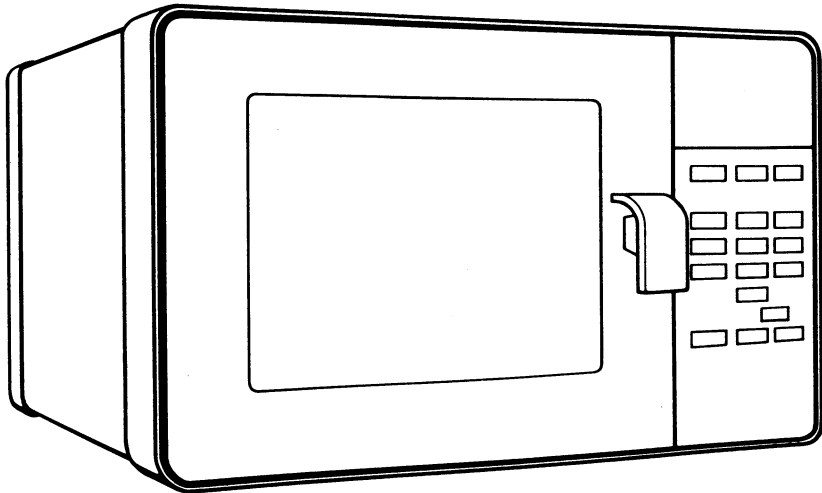

Model No: MW 1135
: MW 2135

ZANUSSI
The appliance of science

Contents

Page	3	Specifications
	4	Installation
	5	Features Diagram
	6	Getting to Know Your Oven
	7	Getting to Know Your Control Panel
	9	Using your Microwave Oven
	10	Operating the Oven
	23	Shelf Cooking
	25	Safety Facts
	26	Microwave Cooking Terms and Techniques
	27	Cleaning and Maintenance
	28	Questions and Answers
	29	What Happens if Something Goes Wrong
	30	Zanussi Guarantee Conditions
	31	Zanussi 5 Year Cover

Important: the use of this new appliance is quite simple. However, to obtain the best results, it is recommended that you carefully read this handbook and follow all instructions prior to operating the appliance for the first time. This handbook provides all necessary instructions for a correct installation, use and care of the appliance and also gives a number of useful hints.

Specifications

Power source:	240 volts A.C. 50Hz 3 wire grounded circuit
Power consumption:	1400 watts/input power 700 watts/output power
Oscillating frequency:	2450 MHz
Exterior dimensions:	Height: 35.2 cm Width: 55.8 cm Depth: 46.3 cm
Interior dimensions:	Height: 24.3 cm Width: 38.4 cm Depth: 38.4 cm
Oven capacity:	1.3 cu ft
Weight:	24.7 kg

Installation

Positioning

This oven is free-standing and can be placed wherever you choose within reach of a power outlet. Ensure the surface is level and that the oven has adequate ventilation. There must be at least 2.5 cm/1 inch of clearance at the top, 4 cm/1½ inches at the back and 2.5 cm/ 1 inch each side.

NOTE: Do not store cookbooks or this instruction book inside or underneath the oven.

Electrical Connection

For your convenience and safety your new Zanussi microwave comes ready fitted with a moulded flex and plug. All you have to do is push the plug into a 13 amp power socket and switch on. However, if for some reason you need to replace this plug with one of your own, you will find the wires inside the flex are colour coded as follows:

GREEN AND YELLOW – EARTH
BLUE – NEUTRAL
BROWN – LIVE

Make sure you connect each wire to the correct terminal inside the plug. The plug's terminals may be colour coded in the same way as the wires. If not the earth terminal will either be coloured black, or be marked with the letter 'L.'

Fuses

The appliance's moulded on plug is supplied fitted with a 13 amp BS1362 fuse. If this fuse blows you can replace it in the following way:

– Remove the plug from the power socket and use a small screwdriver to lever out the red plastic fuse carrier located between the

plug's prongs, together with the old fuse. Fit it with a new 13 amp fuse and clip it back into the plug. Make sure your new fuse is 'ASTA' approved. If the carrier is damaged you can get a new one from your local Zanussi Service Agent.

Safety

The manufacturer declines to accept any liability should these safety measures not be observed;

- Check that the supply flex and any other wiring is positioned in such a way that when the microwave oven is operating its temperature at any point is less than 50 degrees C above the ambient temperature of the room.
- Never remove the rear panel of the oven to gain access to the terminal board. If an extension is required it should be made using the standardised plug and the external cable and it should be capable of carrying the expected load.
- Check that the fuse and domestic installation are suitable to carry the electric load of this appliance (see rating plate at the back of the oven).
- Check the appliance is properly earthed according to existing rules and regulations.
- The appliance meets the requirements laid down in EEC Directive No. 76/889 and amendment 82/499 relating to the suppression of radio and TV interference.

IMPORTANT: UNDER NO CIRCUMSTANCES SHOULD ANY SERVICE REPAIR WORK BE CARRIED OUT ON THIS APPLIANCE BY UNQUALIFIED PERSONS.

Features

- A: Control Panel**
- B: Probe Plug Socket**
- C: Temperature Probe**
- D: Sealed-in Oven Floor**
- E: Shelf Positioning Lugs**
- F: Safety Interlock System**
- G: Door Handle**
- H: Door**
- I: Stirrer Cover**
- J: Light**
- K: Metal Oven Shelf**
- 1: Sensor**
- 2: Handle**
- 3: Plug**

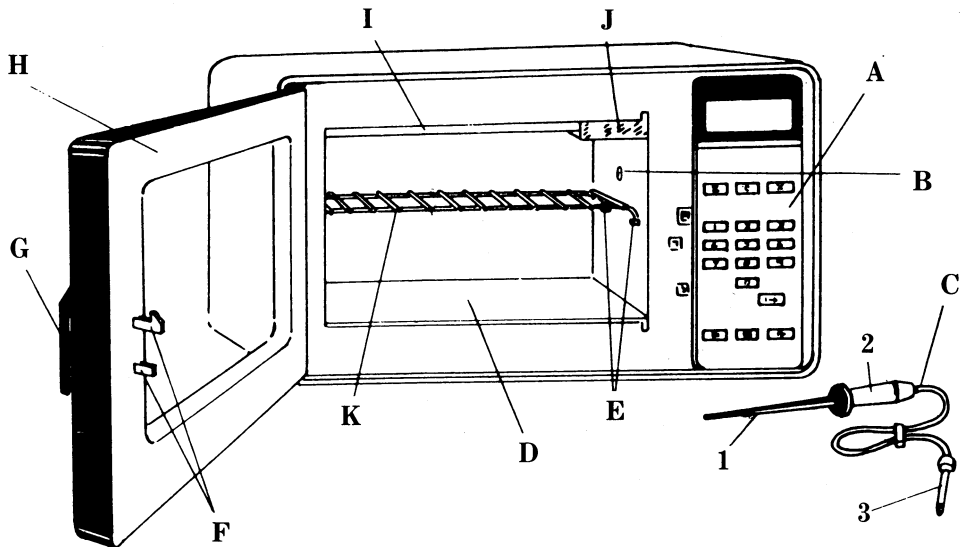

Getting to Know Your Oven

- A: Control Panel
- B: Probe Plug Socket
- C: Temperature Probe
- D: Sealed-in Oven Floor
- E: Shelf Positioning Lugs
- F: Safety Interlock System
- G: Door Handle
- H: Door
- I: Stirrer Cover
- J: Light
- K: Metal Oven Shelf

A – Control Panel

This controls the programming of the microwave oven. (See 'Getting to Know Your Control Panel').

B – Probe Plug Socket

This is where the plug of the temperature probe is inserted into the oven when the oven is to be used for cooking by temperature and not by time. Only use the probe supplied with the oven in your Zanussi Microwave.

C – Temperature Probe

The temperature probe consists of three important components.

- 1 – Sensor: First 12 mm of pointed metal portion of the probe that is inserted or placed into food to sense internal temperatures.
- 2 – Probe Handle: Designed for easy grip and so it can rest on the side of a dish or mug to prevent probe from slipping.
- 3 – Plug: End of the temperature probe that is inserted into the probe socket inside the oven cavity.

D – Sealed-in Oven Floor

This sealed-in oven floor allows the food to be penetrated from the base upwards. The

microwaves pass through the oven floor and bounce off the metal base back into the oven cavity.

The oven floor is sealed-in for easy cleaning.

E – Shelf Positioning Lugs

Used to support the metal shelf.

F – Safety Interlock System

This ensures that the oven cannot operate with the door open. The oven automatically switches off when the door is opened.

G – Door Handle

Lift the handle from the bottom to open the door. As the door opens the interior light comes on. To close the door, just push it back into place until you hear a click.

H – Oven Door

The door has two skins sandwiching a metal mesh. The mesh deflects the microwaves back into the oven cavity. The door has also been designed to give clear vision to the inside of the oven.

I – Stirrer Cover

This plastic cover protects the stirrer from a build up of soil. The blade is designed to distribute the microwaves evenly throughout the oven cavity. The stirrer cover should not be removed.

J – Light

The light operates when the oven is in use or the door is opened. It switches off at the same time as the programme finishes.

K – Metal Oven Shelf

Used when cooking complete meals, or when using more than one dish in the oven. Shelf should be removed when not being used.

Getting to Know Your Control Panel

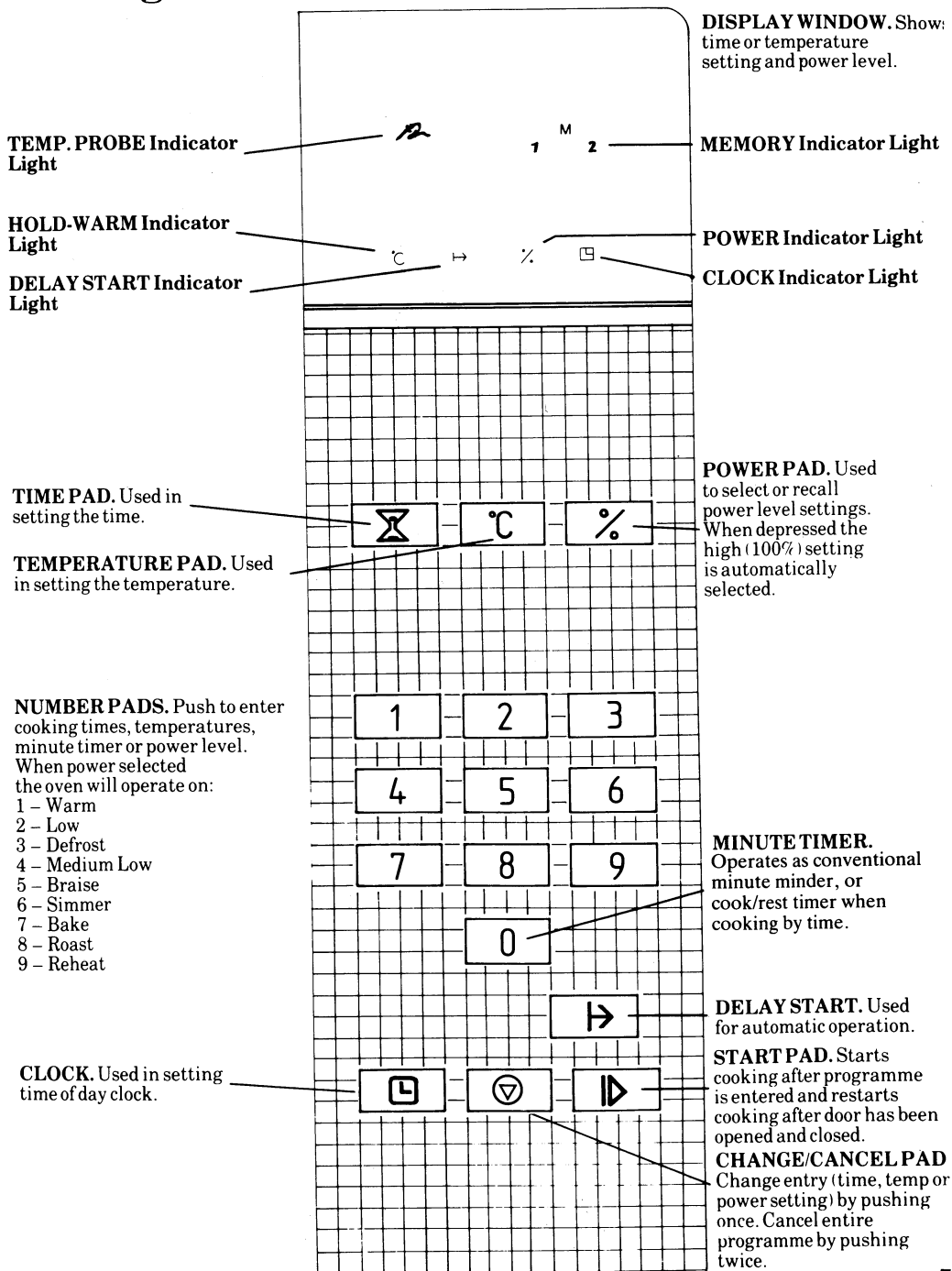

- 1 – Hold Warm Indicator Light
- 2 – Delay Start Indicator Light
- 3 – Temperature Probe Indicator Light
- 4 – Memory
- 5 – Power Level Indicator Light
- 6 – Clock Indicator Light
- 7 – Time Set Pad
- 8 – Power Level Pad
- 9 – Temperature Set Pad
- 10 – Number Pads
- 11 – Start Pad
- 12 – Change/Cancel Pad
- 13 – Clock Set Pad
- 14 – Delay Start Pad

1 – Hold Warm Indicator Light

Small light which indicates when the hold warm programme is in operation.

2 – Delay Start Indicator Light

Small light indicates when the oven is programmed for a delay start.

3 – Temperature Probe Indicator Light

Small light indicates when temperature probe is in operation.

4 – Memory 1 and Memory 2 Indicator Light

Small lights indicate when the memories have been programmed.

5 – Power Level Indicator Light

Small light appears when the power level is programmed.

6 – Clock Indicator Light

Small light indicates when clock is in operation.

7 – Time Pad

This pad should be depressed once before entering the desired time required for the programme.

8 – Power Selection Pad

Use this pad to select the appropriate power level. When depressed the High (100%) setting is automatically selected, to adjust simply press the appropriate number pad which reduces the power in increments of 10% i.e. 3=30%. To recall the power selected during oven operation press the power pad once. To revert to time count-down depress the start pad once.

9 – Temperature Pad

This pad is used when operating the microwave oven with the temperature probe. After inserting the probe into its socket, depress this pad and input the selected temperature by depressing the appropriate number pads.

10 – Number Pads

These pads are used (after the function pad selected has been depressed) to enter either cooking time, temperatures, minute-timer, power levels and time-of-day.

11 – Start Pad

Starts cooking after the programme has been entered, and restarts cooking after door has been opened and closed.

12 – Change/Cancel Pad

This pad will alter entry of time, power or temperature setting by touching once. Cancel entire programme by touching twice.

13 – Clock Set Pad

Touch when setting the time of the day clock.

14 – Delay Start Pad

Use this pad when the oven is required to be programmed for automatic cooking.

Using Your Microwave Oven

Microwave cooking is very versatile. It enables you to cook, reheat roast, simmer, hold-warm and even defrost with speed and convenience.

As microwaving is such a new and fast way of cooking, you must be prepared to gradually become more adventurous as you progress.

Start with something easy; heat a cup of coffee in a mug for two minutes, but open the door at any time and check if the coffee is as hot as you like it. Next try heating leftovers on a plate. An average serving takes about 2-3 minutes on power level 8. Look for steam or test the food to see if it is ready.

Feel free to open the door at any time. If additional time is needed, add time gradually. It is better to under estimate than over estimate.

Before using the microwave oven for the first time, be sure all the packaging materials from both the outside and inside of the oven have been removed. Wipe out the inside of the oven with a damp cloth.

The Time of the Day Clock

When the oven is plugged in the clock display window will remain blank unless you set the time of day.

Once set, the time of day is always displayed when no other cooking function is being used.

If time of day is not set, a colon will appear in the display window for five minutes after cooking is complete then the display window will go blank.



The time of day can be checked once a programme has been set, by touching the clock pad, the time will remain displayed until the start pad is touched again. This does not interrupt the running of the programme.

After a power cut the display window will be blank and you will have to re-set the clock.



Setting the Clock

The clock operates on a 24 hour cycle and changes in one minute increments.

Setting the Clock for the First Time

1. PUSH THE  CLOCK PAD. The clock indicator light will come on and will always be on when the time of day is displayed.
2. PUSH  CHANGE/CANCEL PAD ONCE.
3. SET THE TIME OF DAY BY PUSHING THE APPROPRIATE NUMBER PADS. The time you have set will appear in the display window.
4. PUSH  START PAD. The time of day will now be activated.

Altering the Time of Day Clock

1. PUSH THE  CLOCK PAD. No change will occur in the display window.
2. PUSH  CHANGE/CANCEL PAD. The display window will clear leaving only the clock indicator light.
3. Set the time of day as before and push the  start pad.

Operating the Oven

Cooking with the Microwave

Your Zanussi Microwave enables you to control your microwave cooking either by time or by temperature and it also has a variable power feature which is used in conjunction with either method. Cooking by Time is ideal when the foods appearance, taste or touch indicates when it is ready e.g. potatoes, cakes, sauces.

Cooking by Temperature is ideal when the internal temperature of the food indicates if it is cooked e.g. roasts, reheating casseroles, beverages.

Variable Power gives you total flexibility to select the microwave speed suitable for the food you are cooking.

Variable Power Feature

There are ten power settings which allow total flexibility in choosing the speed of microwave cooking. This enables you to get the best cooking results for each type of food, just as you would use different temperature settings in conventional cooking.

The settings range from power level 10 which is 100% of power, to power level 1 which is 10% of power.

Cooking by Time

Every microwave recipe gives only an approximate cooking time as so many factors such as food temperature, dish shape, arrangement of food and density control the precise time. It is advisable to always start with the shorter time and then add more time as needed.

Remember the cookbook is only a guide.

To Set the Programme

1. OPEN THE DOOR. By pulling up the

door handle. The interior light will come on.

2. PLACE THE FOOD IN THE OVEN AND CLOSE THE DOOR. The interior light will go off. The oven is ready to programme.

3. PUSH THE [X] TIME PAD. The time of day clock will disappear, leaving only the colon and memory 1 indicator light displayed.

4. SET THE DESIRED TIME. Push the appropriate number pads. The time will appear in the display window.

For example: To set the time for 5 minutes 30 seconds, press [5], [3], [0].

To set the time for 10 minutes press [1], [0], [0], [0].

5. PUSH THE [%] POWER LEVEL PAD. 'HI' will appear in the display window. This is to remind you that the oven will always operate at full power unless you change the power level. The power level indicator light will be displayed.

6. SELECT THE POWER LEVEL YOU DESIRE. For example: If you want to defrost a food item, push number pad 3. '30' will appear in the display window which means the oven will operate at 30% of full power.

7. PUSH THE [▶] START PAD. The oven will begin to operate and the time will start to count down in seconds. When the time is up a tone will sound three times and the oven will automatically stop cooking. The oven light will go out and the fan switches off, the display window reverts back to the time of day.



8. OPEN THE DOOR, REMOVE THE FOOD THEN CLOSE THE DOOR.

The oven door may be opened at any time during the cooking time should you wish to check or stir the food. The oven automatically stops, the light goes out and the fan will stop. Check the food and should it require more cooking return it to the oven, close the door touch the Start Pad. The oven will continue to cook counting the remaining programmed cooking time in the display window. If however, the food is ready, touch Change/Cancel pad twice to cancel the programme. The time of day will then be displayed if the clock is set.

To Check the Programme Whilst the Oven is in Operation



The time selected will be counting down.

To Check the Power Level

1. PUSH  POWER LEVEL PAD. The power level selected will appear in the display window.
2. PUSH  START PAD TO RETURN TO THE TIME COUNTING DOWN.

To Change the Programme

To change the time.

1. PUSH  CHANGE/CANCEL PAD ONCE. Display will clear and oven will stop.
2. ENTER NEW TIME BY PUSHING THE APPROPRIATE NUMBER PAD.
3. PUSH  START PAD. The oven will resume operation with new time counting down in the display window.

To Change the Power Level

1. PUSH  POWER LEVEL PAD.
2. ENTER NEW POWER LEVEL BY PUSHING THE APPROPRIATE PADS. Oven will continue to run.

3. PUSH  START PAD. The oven will operate at the new power level.

Some Basic Uses for Variable Power

POWER LEVEL	% Power	General Uses
1 – WARM	10	Holding food warm
2 – LOW	20	Softening butter – raising bread
3 – DEFROST	30	Defrosting
4 – MED LOW	40	Warming syrups and sauces
5 – BRAISE	50	Slow cooking
6 – SIMMER	60	Heating frozen main meal dishes e.g. fish pies, curries, casseroles
7 – BAKE	70	Start cakes – cook soups and stews
8 – ROAST	80	Roasting and reheating plated and leftover foods
9 – REHEAT	90	Reheating larger items
10 – High (100%)	100	Full power for vegetables, fish, hot beverages, preheating microwave browner

Cooking by Temperature

The temperature probe helps to eliminate much of the guesswork when cooking dense foods in the microwave. The probe is inserted into the centre of the food, and plugged in at the probe plug socket. The oven then has the facility to cook by judging the internal temperature of the food. Once the programmed temperature is reached the oven will automatically switch into Hold-Warm setting which will maintain the temperature for 60 minutes. It is not recommended to use the probe on thin food items such as chops, steaks and foods that require tenderising by simmering. If the microwave stops during the cooking programme this indicates either that the probe has been inserted incorrectly or that the food is unsuitable for this method of microwave cooking.

Automatic Hold-Warm

The Hold-Warm feature enables you to keep food warm and is used in conjunction with the probe. Once the food has reached the programmed temperature the microwave automatically changes to a Hold-Warm programme, and maintains the food at the programmed temperature for up to 60 minutes. It is very useful for keeping food hot but don't forget one of the many advantages of a microwave oven is that it reheats food very quickly and easily especially if the quantities are small.

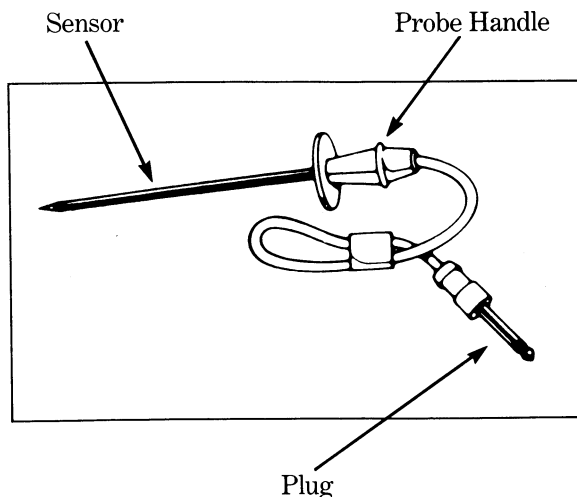

To Set the Programme

1. INSERT THE TEMPERATURE PROBE INTO THE FOOD TO BE COOKED.

2. OPEN THE OVEN DOOR. The light will come on.

3. PLACE THE FOOD IN THE OVEN AND INSERT THE TEMPERATURE PROBE PLUG INTO THE SOCKET.

4. CLOSE THE OVEN DOOR. The light will go out and the oven is ready to programme.

5. PUSH THE  TEMPERATURE PAD. 'C' for centigrade will appear in the display window with the memory 1 indicator lit.

6. SET THE DESIRED TEMPERATURE BY PUSHING THE APPROPRIATE NUMBER PADS. The temperature selected will appear in the display window. Temperatures from 34°C to 94°C can be entered. If temperatures below 34°C or over 94°C are entered a tone will sound when either the start pad or the power level pad are pushed. The display will go blank, ready for resetting of temperature.

7. PUSH  POWER LEVEL PAD. 'H1' will appear in the display window and the oven will operate at that power level unless the setting is altered.

8. SELECT THE POWER LEVEL YOU DESIRE. Push the appropriate number pad. The power level you have selected will appear in the display window.

9. PUSH THE  START PAD. '-34' will appear in the display window if the starting temperature of the food is below 34°C. As the food cooks the temperature display will increase in 2 degree increments.

10. When the programmed temperature is reached a tone will sound three times and the oven will automatically reduce the power level and change into the Hold-Warm programme. When in Hold-Warm, the display will show time counting down from 60 minutes to indicate how long it has been in the Hold-Warm programme.

11. When the door is open the programme is interrupted. To restart it, close the door and push the  start pad again.

Alternatively to cancel the entire programme push  Change/Cancel pad twice.

12. OPEN THE DOOR, REMOVE THE PROBE FROM THE SOCKET, REMOVE THE FOOD AND CLOSE THE DOOR.

To Check the Programme Whilst the Oven is in Operation

1. PUSH THE  TEMPERATURE PAD. The temperature selected will appear in the display window.

2. PUSH THE  POWER LEVEL PAD. The power level selected will appear in the display window.

3. PUSH  START PAD TO RETURN TO THE PROGRAMME.

To Change the Programme TO CHANGE THE TEMPERATURE.

1. PUSH  TEMPERATURE PAD. Original temperature setting will appear in the display window.

2. PUSH  CHANGE/CANCEL PAD ONCE. The display window will go blank and the oven will stop.

3. ENTER NEW TEMPERATURE SETTING BY PUSHING THE APPROPRIATE NUMBER PADS.

4. PUSH  START PAD. The oven will resume operation with new temperature setting.

To change the power level proceed as previously explained (Page 11).

Temperature Probe Food Guide

The following chart is designed to help you use the probe. The suggested internal temperatures are only approximate, but you will soon find which setting suits your own taste.

Probe Cooking Chart

FOODS	PROBE SETTING	TEMPERATURE SETTING	SPECIAL INSTRUCTIONS
Bacon Joints	8 Roast	65	Insert the probe one end into the fleshy part, cook rind down and cover the edges of the joint with strips of foil
Beef Joint	<input type="checkbox"/> HIGH	52	Insert from one end into fleshy part
– medium	<input type="checkbox"/> HIGH	64	As above
– well done	<input type="checkbox"/> HIGH	68	As above
Beef, minced	<input type="checkbox"/> HIGH	66	–
Beverages, warm	<input type="checkbox"/> HIGH	49–54	Position sensor in centre of container
– medium	<input type="checkbox"/> HIGH	54–66	
– hot	<input type="checkbox"/> HIGH	66–76	
Casseroles	9 Reheat	66	Place in centre of food, stir before serving
Convenience Foods	9 Reheat	65	Insert sensor in densest part
Fish, whole	<input type="checkbox"/> HIGH	60	Place in centre of fish
– shellfish	<input type="checkbox"/> HIGH	70	
Lamb Joint			
– medium	<input type="checkbox"/> HIGH	68	As beef
– well done	<input type="checkbox"/> HIGH	82	As beef
Meatloaf	<input type="checkbox"/> HIGH	60	Insert sensor into centre – it must touch the base of the dish
Pork Joint	<input type="checkbox"/> HIGH	70	As beef
Poultry	<input type="checkbox"/> HIGH	82	Insert in thickest part of breast meat – test if cooked by normal methods

Sauces – smooth – with added ingredients	<input type="checkbox"/> HIGH	70	Place in centre of dish, the sensor tip may touch the bottom of the container
	<input type="checkbox"/> HIGH	90	
Shepherd's Pie Soup	<input type="checkbox"/> HIGH	60	Place sensor in centre of meat base Place in bowl, the tip may touch the base. Soup with added ingredients will need to be heated to a higher temperature than clear soup
	9 Reheat	65–70	
Syrup	8 Roast	66	–
Veal, roast	HIGH	70	As beef
Vegetables, canned or pre-cooked	9 Reheat	66	Place sensor in centre of dish
Venison	<input type="checkbox"/> HIGH	70	As beef

Here are a few tips relating to cooking certain food:

MEAT

- If frozen meat is used always ensure it is completely thawed before attempting to cook it.
- To obtain an even heat distribution it is best to choose joints of a uniform shape. Boned and rolled ones cook better than joints with the bone still in.
- If a bone-in meat cut is used the sensor must not touch the bone.
- Allow the joint to stand after cooking so the joint firms up for easier carving.

CASSEROLES

- Cover the food partially, this helps speed up the reheating time.
- Stir the food before serving so the heat is evenly distributed.
- Allow the dish to stand for a few minutes before serving so the heat penetrates completely and the dish finishes cooking.

OTHER FOODS

- Use the probe for recipes which you are advised 'not to boil' such as egg dishes.

How to Insert Food Temperature Sensor in Meats

Boneless meat cuts

The Food Temperature sensor should be placed in the meat from the end and pushed toward centre of the fleshy part.

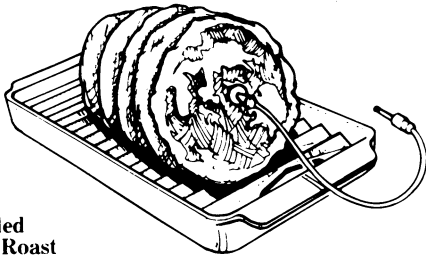
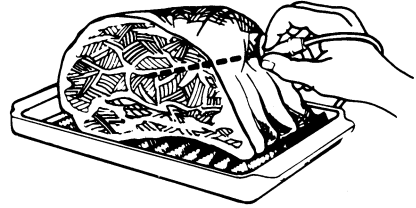

**Rolled
Rib Roast**

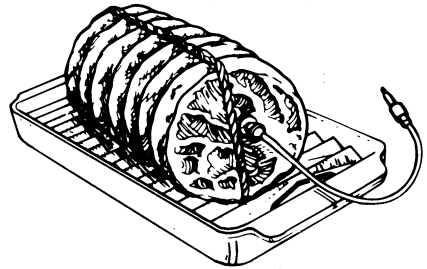

Bone-in meat cuts

Insert the Food Temperature sensor in the fleshy part of the meat. Sensor should not come in contact with bone, marrow or pocket of fat.

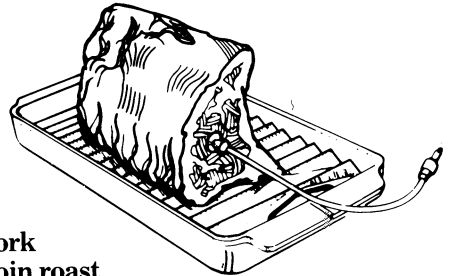

**Pork
Loin roast**

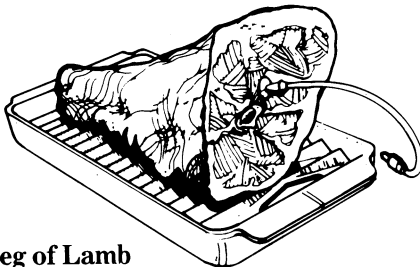

Leg of Lamb

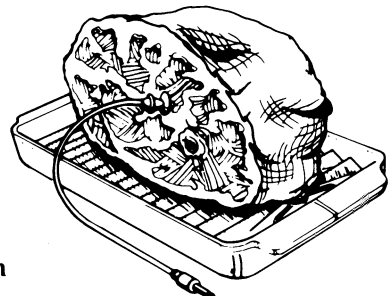

Ham

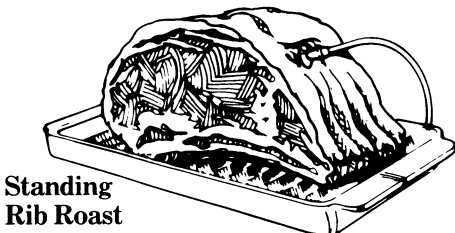

**Standing
Rib Roast**

Advice When Using the Temperature Probe

1. The Temperature Probe must be inserted into the thickest part of the meat or in the centre of the food to be reheated.
2. Only the first 12 mm/½ inch of the probe contains the sensor so ensure the tip is inserted into the densest part of the food to be cooked.
3. Never operate the oven empty with the Temperature Probe in position.
4. The tip of the Temperature Probe should not touch any part of the oven interior when in operation.
5. **DO NOT USE THE PROBE IN A CONVENTIONAL OVEN OR ANY OTHER MICROWAVE.**
6. Never attempt to insert the probe into frozen food.
7. Never wash the probe in a dishwasher.

Cooking With Memories

Your Zanussi microwave has two memories which can be programmed to use any combination of variable power settings, time or temperature. Many microwave recipes use different power settings at various times during the cooking process. The memory feature once programmed automatically changes power settings, cooking times, or temperatures. A tone will sound when the memory changes programme which helps to remind you at what stage you are in the recipe. The memories also have a Delay Start feature enabling the microwave oven to be programmed to cook automatically.

Here are a few ways in which the memory feature can be used:

- Let the memory tone remind you to stir the sauce or add the remaining ingredients to a main dish or stew.
- Use the memory with the Minute Timer (0 Power) to time the standing time after cooking or defrosting.
- Programme a memory tone to remind you when the chicken has to be basted.
- Let the memory automatically alter the power setting for those recipes that require different power levels during their cooking, such as soups, cakes, casseroles.

Operating With Memories

1. OPEN DOOR. The interior light will come on.
2. PLACE THE FOOD IN THE OVEN. If cooking by temperature insert the temperature probe into the food and the plug into the socket.

3. CLOSE THE DOOR. The oven is ready to be programmed.

4. PUSH THE  TIME PAD OR THE  TEMPERATURE PAD. The indicator for 'Memory 1' will be displayed.



5. SET THE DESIRED TIME OR TEMPERATURE PUSHING THE APPROPRIATE NUMBER PADS. The time or temperature selected will appear in the display window.

6. PUSH THE  POWER LEVEL PAD. The indicator for power will be displayed and 'HI' will appear in the display window. This is to remind you that the oven will always operate at full power unless you change the power level.

7. SELECT THE POWER LEVEL YOU DESIRE.

DO NOT PRESS THE  START PAD.

To Enter the Second Memory

PUSH THE  TIME PAD OR THE  TEMPERATURE PAD. The indicator light showing that you are in 'Memory 2' will appear.

9. Programme in the next set of cooking instructions as for 'Memory 1'.

10. PUSH THE  START PAD. The oven will begin to cook using 'Memory 1' instructions you have set.

11. When the oven has completed Memory 1 instructions a tone will sound once and the oven will automatically switch to the second memory. The indicator light will show that the oven is cooking in the second memory.

12. At the end of the cooking time the tone will sound three times and then if the oven is programmed to cook by temperature it will automatically revert to the Hold-Warm programme until it is cancelled.

13. OPEN THE DOOR REMOVE THE FOOD (AND PROBE IF USED) CLOSE THE DOOR.

To Check the Programme Set Time or Temperature

1. Push [⌘] TIME OR [°C] TEMPERATURE Pad. Time or set temperature will be displayed.
2. Push [⌘] TIME OR [°C] TEMPERATURE Pad again; next memory will be displayed.
3. Push [▶] START Pad to return to time counting or actual temperature..

Power setting

1. Push [⌘] POWER Level Pad. The Power level setting will appear in Display.
2. Push [⌘] POWER Level Pad again; next power memory will be displayed.
3. Push [▶] START Pad to return to time counting or actual temperature.

To Change the Programme

Time or Temperature

1. PUSH [⌘] TIME OR [°C] TEMPERATURE Pad until memory to be changed is in the Display.
2. Push [⊖] CHANGE/CANCEL Pad once. Oven will stop.
3. Enter in new time or temperature by touching Number Pad.
4. Push [▶] START.

Power

1. PUSH [⌘] TIME OR [°C] TEMPERATURE PAD until memory to be changed is in the Display.
2. Push [⌘] POWER Level pad. Oven will continue to run.
3. Enter new Power setting.
4. Push [▶] START Pad and oven will operate at new Power setting.

The Delay Start

The delay start feature on your microwave oven means you can delay the start of cooking for up to 24 hours after the oven has been programmed.

Points to Remember

1. Select the foods to be cooked carefully. It is advisable not to use foods that perish easily such as eggs, milk, fish or fresh meat and poultry.
2. Avoid recipes that require stirring.
3. Reduce the cooking times slightly as the food will be a little warmer than usual because it has been standing in the microwave prior to cooking.

Operating the Delay Start

1. Check the time in the display window is correct. If not change it following the instructions on page 9.
2. Place the food in the oven and close the door.
3. PUSH THE [▶] DELAY START PAD. The colon and Delay Start Indicator Light will appear in the Display Window.
4. SET THE DESIRED START TIME. Push the appropriate number pads for time of day when the food should start cooking.
5. PUSH [⌘] TIME PAD OR [°C] TEMPERATURE PAD. The Display Window will show a colon or a 'C' and the Memory 1 Indicator Light will come on.
6. Set the cooking time or temperature by pushing the appropriate number pads. Set the power level by pushing the power level pad and then the appropriate number pad.
7. If two memories are to be used repeat steps 5 and 6 a second time to programme a second memory.

8. PUSH THE [F] START PAD. The time of day will appear in the Display Window. The Clock, Delay Start and Memory Indicator Lights will be on. The oven will start cooking automatically at the Programmed Start Time. The cooking time or temperature will then be displayed.

To Check the Programme

1. PUSH THE [D] DELAY START PAD TO CONFIRM THE STARTING TIME.
2. PUSH THE [X] TIME OR THE [C] TEMPERATURE PAD TO CONFIRM TIME OR TEMPERATURE SET.
3. PUSH THE [%] POWER LEVEL PAD TO CHECK THE POWER LEVEL SET.

The Timer

The timer has many uses when cooking with the microwave and of course it can also be used as a minute timer when cooking conventionally.

Use the timer to help you do the following:

- To remind you when standing time is complete.
- To time the required mixing or beating when preparing a recipe.
- To remind you when the final items of food for dinner have to be cooked.
- To time any cooking operation, such as boiling an egg.

When the timer is programmed it uses no microwave energy and so the oven is not cooking. If the interior light comes on and you hear the fan start to work when the Start Pad is touched the time has been incorrectly set. Push the [V] Change/Cancel pad twice and then reprogramme.

Operating The Minute Minder

1. PUSH THE [X] TIME PAD.
2. SET THE DESIRED TIME.
3. PUSH THE [%] POWER LEVEL PAD.
4. PUSH THE [0] NUMBER PAD. '00' will appear in the display window indicating that there is no power level set.
5. PUSH THE [D] START PAD. Time will begin counting down in the display window with the oven not in operation. When time is up, a tone will sound three times. The time of the day will then be displayed.

Speed Defrost With Memory

Microwaves have a difficult time penetrating frozen foods in the first few minutes and penetrate foods more easily when they are partially defrosted. The defrost time can be speeded up by starting with microwave cooking on HIGH and then automatically reducing to the [3] DEFROST setting.

To Speed Defrost With Memory

1. Microwave on HIGH for 2 minutes per pound of dense food items.
2. Then microwave on [3] DEFROST for 3 minutes per pound or until food is thawed. Defrost time will be greatly reduced.

Example: You would normally defrost a 4 lb roast on [3] DEFROST for 35 minutes. With Speed Defrost you would need only 20 minutes:

1. Microwave on HIGH for 2 minutes per pound (2 minutes \times 4 pounds = 8 minutes).
2. Microwave on [3] DEFROST for 3 minutes per pound (3 minutes \times 4 pounds = 12 minutes).

Shelf Cooking

Using the Metal Shelf

The metal shelf enables you to microwave a number of dishes in approximately the same time.

How to Insert the Shelf

1. Tip the shelf slightly, left side down and insert into the oven. Slide the shelf into the left supports.

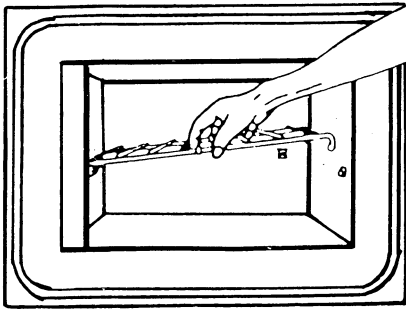

2. Lower the shelf onto the right side and back supports. Making sure the shelf is as far back as it will go, push down gently to secure in place.

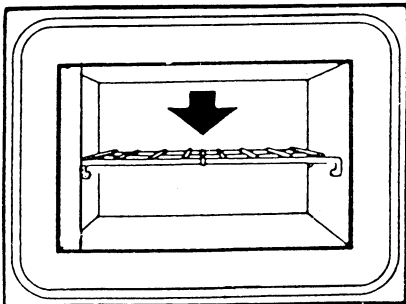

Shelf Cooking

By using the metal shelf you are able to cook fast and slow cooking foods in approximately the same time.

Dense foods such as roasts, potatoes or casseroles should be placed on the metal shelf. Faster cooking foods such as frozen vegetables or beverages should be placed underneath.

As the microwaves enter the cavity at the top, whatever is placed on the metal shelf will receive the majority of the microwave energy. Therefore foods which are placed on the base will receive less microwave energy, thus enabling you to cook the food in approximately the same time. Very fast cooking food can be added later as you would when cooking conventionally.

It should be remembered that when more food is placed in the oven this will result in a longer cooking time.

Tips on Shelf Cooking

- Stagger the food so that no food is directly above another.
- Check your meal while cooking. Stir if needed and add or remove food as required for the desired results.
- Turn or rotate dense food such as a roast.
- For the quickest cooking time 100% (High) power should be used. This is because the increase quantity of foods cuts the microwave energy available to each food.
- For foods which contain delicate ingredients such as cream and eggs and for less tender cuts of meat, you may

need to cook more slowly by lowering the power level, just as you would when cooking conventionally. Listed are some typical foods which you might prepare as a main dish in a 'Meal-In-One'. Use the cooking times suggested as an approximate guide when making up your own 'Meal-In-One' ideas. The cooking times shown, take into consideration the fact that you will be cooking vegetables, desserts, etc. along with the main dish.

The Microwave cooking shelf should NOT be used in the same manner as a conventional cooking shelf.

It is only necessary to use the Microwave shelf where the number of items to be cooked exceed the space available in the base of the oven. We would also point out that items of food do not cook any quicker if placed on the shelf ie; in a higher position within the cavity. Never use the shelf if the base of the oven is not filled.

MEALS	MICROWAVE TIME RANGE	COMMENTS
Casserole Meals Chicken Meals Scrambled Eggs and Bacon	12 to 35 mins. 25 to 35 mins. 9 to 12 mins.	Stir eggs ¼ way through. Add time for bacon if necessary
Fish Meals	9 to 16 mins.	
Meatloaf/Meatball Meals	20 to 35 mins.	
Rib/Chop Meals	25 to 40 mins.	
Roast Meals	40 to 50 mins.	
Soup	4 to 7 mins.	
Steak Meals	8 to 12 mins, plus preheating time for microwave grill.	

Safety Facts

To ensure maximum satisfaction from your microwave oven we would like to advise you of some precautions to observe when using your new microwave cooker.

● The microwave oven cooks much faster than conventional ovens. It is wise to take special care when you are cooking something for which specific timings have not been recommended. This applies particularly when reheating foods. Always watch the cooking or heating of the food in question, giving it short cooking times and adding more until you have obtained the desired result. You will soon learn the correct timings for cooking or heating your favourite foods. It is important to remember that it is possible to burn foods if they are cooked for too long, but the burning will occur inside the food first and may only become apparent by smell.

● Unlike conventional cooking microwaves do not radiate heat, they generate it within the food. Therefore, the container should only become hot when it is in contact with the food.

Do Not attempt to operate the oven with the door open by tampering with the safety interlocks.

Do Not place any object between the oven front face and the door or allow the sealing surfaces to accumulate dirt.

Do Not use metal cookware in the oven.

CARE SHOULD BE TAKEN WHEN REHEATING ITEMS WITH A HIGH SUGAR OR FAT CONTENT.

When reheating small items such as mince pies, take care to underestimate reheating times rather than overestimate.

Example: 2 mince pies on power level take 20–30 seconds only.

Do Not use the oven for storage when it is not in use.

Do Not attempt to run the oven with no food in it.

Do Not let the timer continue to operate after removing food.

Do Not attempt to cook or reheat eggs in the shell in the microwave oven: They may explode.

Do Not operate the oven if is damaged in any way.

Microwave Cooking Terms and Techniques

Stirring

With foods such as casseroles, sauces and soups it is necessary to stir the ingredients during the cooking time so the heat is evenly distributed.

Arrangement of Food

To ensure even cooking of food it is best to arrange it so the thinner parts are towards the centre of the dish and the thicker more dense parts are on the outside. For example, if cooking chicken drumsticks the narrow end would be in the centre of the dish and the thicker end would be pointing to the outer edge.

Turning Food

Again to ensure even cooking of food, dense items such as hams, roasts or whole poultry should be turned at least once during the cooking programme. When using individual dishes it is advisable at some time during the cooking programme to re-arrange the dishes, so they will all be ready at the same time.

Standing Time

Microwaves penetrate food only to a depth of 4 cm/1½ inches, so the dense food items are best left to stand for a short period of time once the microwave cooking is complete. This ensures the heat inside the food will penetrate to the centre and ensure it is completely cooked. Standing time can take place either on the kitchen surface or in the microwave with the power off. The food is covered, often with foil, and left so the heat can transfer evenly throughout the food. The denser the food the longer the standing time.

Shape of Food

Always aim for uniform shapes to aid the even cooking of food. This is especially relevant when cooking joints of meat and it is advisable to bone and roll joints such as legs of lamb before cooking.

Covering

There are several types of covering and they are all used for different purposes. Plastic film or glass lids help to hold in steam and therefore retain moisture so the food can cook more quickly. When covering food with plastic film, make sure that you are using a film that is specifically recommended for use in a microwave oven. Paper towels or napkins are loose covers used to prevent spitting and also to absorb moisture. Wax paper is also a loose cover which holds in some of the moisture and therefore speeds up the cooking time.

Cookware

The range of cooking utensils that can be used in the microwave is wide. There are many excellent varieties of cookware specially manufactured for use in the microwave/freezer, also much of the conventional kitchen equipment is quite suitable. The basic rule to remember is not to use anything made of metal or with any metal parts and that includes screws, handles, metallic designs on plates, foil dishes, even metal ties on foods from the freezer. Also avoid some plastic such as melamine or urethane, the microwave may warp or crack them. The most suitable dishes are made of china or pottery, ovenproof glass or paper. For further information see your microwave cook book.

Cleaning and Maintenance

Microwave Oven cleaning

Your microwave oven requires a minimum of maintenance. To keep it free from grease and soil build-up, the microwave oven should be cleaned with a damp cloth after each use. A soft nail brush can be used to remove stubborn stains. Odours can be eliminated from the inside of the oven by boiling a solution of one cup of water and several tablespoons of lemon juice in the cavity. We would also recommend occasionally, wiping the oven interior with a sterilising fluid, i.e. Milton, in the interest of hygiene.

Use only a mild detergent, water and a soft clean cloth to clean the oven face and all surfaces. Be careful not to scratch the door and interior surface. Wipe out excess moisture after each use.

Do Not Use: Abrasive cleaners, cleaning pads or steel wool.

Be sure the oven is cleaned carefully after every use.

Replacement of Interior Light

The oven interior light is easily replaced. First unplug the oven. Turn the cooker round and unsnap and remove the 'Lamp Access Cover' on the back of the oven. In some models a screw must first be removed to release the cover. Replace the bulb with a 15-watt (E14) available from hardware stores or the local Zanussi Service Centre.

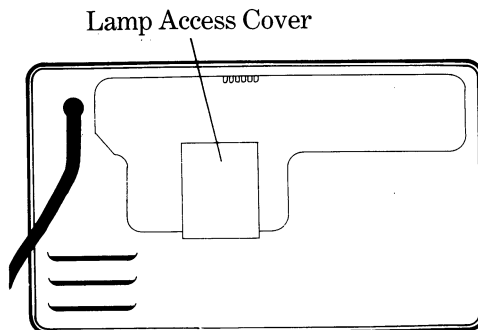

Questions and Answers

Q What happens if I accidentally operate the microwave oven with no food in it?

A While such accidental use of short periods of time does not damage the magnetron, it is not recommended.

Q Is eating food cooked in a microwave oven harmful?

A Microwaves are simply a source of heat energy just like gas and electricity. All three produce cooking in the food itself. Food cooked in a microwave oven is not harmful to eat.

Q Why do I have moisture in the microwave oven after cooking?

A The moisture on the inside of your microwave oven is normal and nothing to worry about. It is caused by the steam from the cooking food hitting a cool oven surface. Wipe excess moisture from the inside of the oven after each use.

Q What causes the oven interior light to dim when using Variable Power?

A This is normal and indicates that the oven is operating and cycling normally.

Q Foods cooked in a microwave oven seem to cool off faster than conventionally cooked foods. Why is that?

A Often the dish used to store foods in the refrigerator is used for heating in the microwave oven. In this case, the cold dish absorbs heat from the food. It may be necessary to heat the food for additional time.

What Happens if Something Goes Wrong

Important

If the oven does not come on:

Check that the appliance is connected correctly;

Check that the switch from the supply to the appliance is ON;

Replace the fuse in the socket, where present, with another of the appropriate rating;

Check that the fuse in the fuse box is intact.

If after all these checks the appliance still does not work, call your local Zanussi Network Service Centre listed in the telephone directory. It helps to jot down the address and telephone number in the space below.

Never attempt to remove the rear panel of the oven or tamper with the oven in any way.

IMPORTANT: UNDER NO CIRCUMSTANCES SHOULD ANY SERVICE REPAIR WORK BE CARRIED OUT ON THIS APPLIANCE BY UNQUALIFIED PERSONS.

Peace of mind for twelve months

ZANUSSI STANDARD GUARANTEE CONDITIONS

This guarantee is in addition to your statutory and other legal rights which will not be excluded or in any way diminished by the return of this guarantee card.

We, Zanussi Limited, guarantee that if within twelve months of the date of the purchase, this ZANUSSI appliance or any part thereof is proved to be defective by reason only of faulty workmanship or materials we will at our option repair or replace the same **FREE OF ANY CHARGE** for labour, materials or carriage on condition that:

- The appliance has been correctly installed and used only on the electricity supply stated on the rating plate.
- The appliance has been used for normal domestic purposes only, and in accordance with the manufacturer's operating and maintenance instructions.
- The appliance has not been serviced, maintained, repaired, taken apart or tampered with by any person not authorised by us.
- The appliance is still in the possession of the original purchaser.

All service work under this guarantee must be undertaken by a Zanussi Network Service Centre.

Any appliance or defective part replaced shall become our property.

Exclusions

This guarantee does not cover:

- Damage or calls resulting from transportation, improper use or neglect, the replacement of any light bulbs or removable parts of glass or plastic.
- Cost incurred for calls to put right machines improperly installed or calls to machines outside the UK and the Republic of Ireland.
- Appliances found to be in use within a commercial environment, plus those which are the subject of rental agreements.

or five years

ZANUSSI 5 YEAR COVER CONDITIONS (See enclosed leaflet)

For a once-only payment you can extend your Standard Guarantee, all the conditions and exclusions of which apply.

1. Products supplied as 'seconds', refurbished, damaged or shop-soiled are not eligible for Zanussi cover.
2. The issue of a cover does NOT by virtue of our having done so, nullify the exclusions.
3. The Engineer will need to check the details of your Cover card and will make a charge for his services if it is not presented to him at the time of his call.
4. The date of purchase, or the date of initial payment (deposit) of the appliance will be deemed the date of commencement of cover.
5. Covers issued are not refundable or transferable.
6. Change of address:
Zanussi Cover Card is valid throughout UK, including Isle of Man, Channel Islands, Northern Ireland and Republic of Ireland and does not require amending. Advice in writing, quoting the 'Cover' Card number is necessary to enable correction of our records.

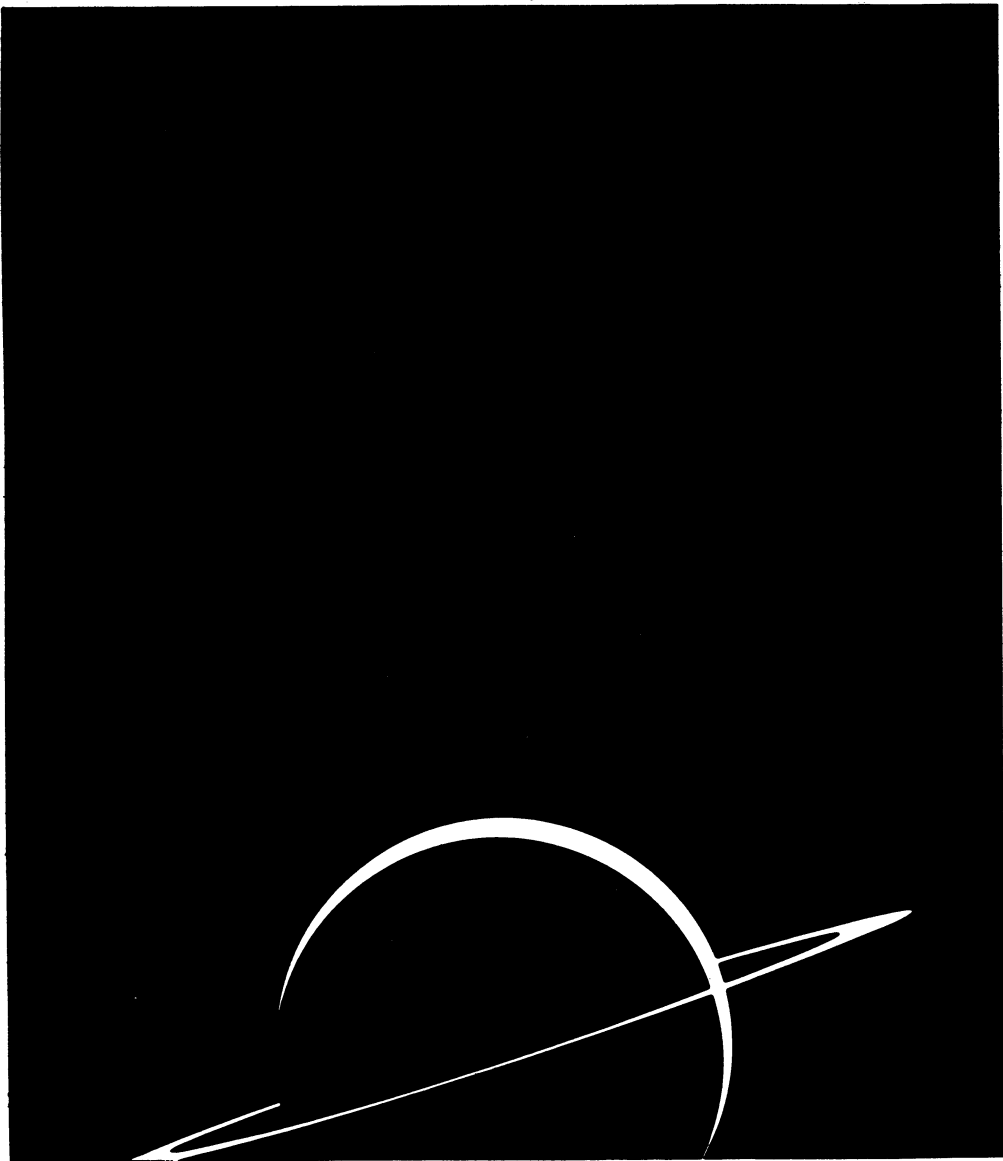

ZANUSSI

The appliance of science

Zanussi Limited, Zanussi House, Hambridge Road, Newbury.
The information in this manual is correct at time of going to press.
Zanussi reserve the right to alter specifications without notice.

Free Manuals Download Website

<http://myh66.com>

<http://usermanuals.us>

<http://www.somanuals.com>

<http://www.4manuals.cc>

<http://www.manual-lib.com>

<http://www.404manual.com>

<http://www.luxmanual.com>

<http://aubethermostatmanual.com>

Golf course search by state

<http://golfingnear.com>

Email search by domain

<http://emailbydomain.com>

Auto manuals search

<http://auto.somanuals.com>

TV manuals search

<http://tv.somanuals.com>