

INSTRUCTIONS FOR THE USE AND CARE OF ZANUSSI MICROWAVE OVEN

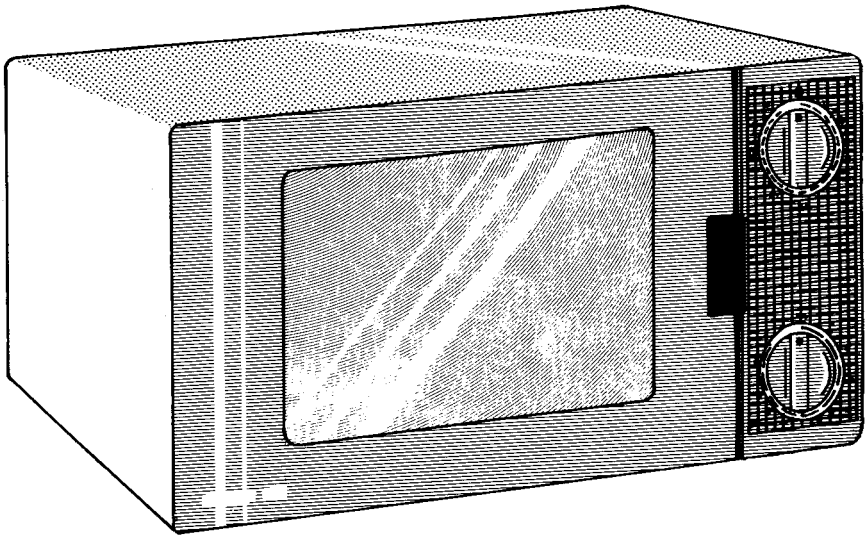

Model No: MW522D

ZANUSSI
The appliance of science

Contents

Page	3	SPECIFICATION
	3	BASIC OVEN FEATURES
	4	INSTALLATION AND ELECTRICAL CONNECTION
	5	Important Facts You Should Know
	6	FEATURES
	7	CONTROL PANEL
	8	USING THE MICROWAVE OVEN
		Microwave Cooking
		Tips On Using the Microwave Oven
	10	OVEN OPERATION
		The Variable Power Feature
		Operating with Time and Variable Power
	11	CLEANING AND MAINTENANCE
	12	QUESTIONS AND ANSWERS
	13	WHAT HAPPENS IF SOMETHING GOES WRONG

Important: the use of this new appliance is quite simple. However, to obtain the best results, it is recommended that you carefully read this handbook and follow all instructions prior to operating the appliance for the first time. This handbook provides all necessary instructions for a correct installation, use and care of the appliance and also gives a number of useful hints.

UNDER NO CIRCUMSTANCES SHOULD ANY SERVICE REPAIR WORK BE CARRIED OUT ON THIS APPLIANCE BY UNQUALIFIED PERSONS.

Specifications

POWER SOURCE

240 volts A.C 50 Hz

POWER CONSUMPTION

1200 watts/input power

600 watts/output

OSCILLATING FREQUENCY

2450 MHz

EXTERIOR DIMENSIONS

Height 24.1 cm

Width 46.7 cm

Depth 33.0 cm

INTERIOR DIMENSIONS

Height 15.2 cm

Width 31.1 cm

Depth 27.9 cm

WEIGHT

15.0 kg

Basic Oven Features

With your new microwave oven, you can enjoy the speed and convenience of a compact microwave oven. Be sure to carefully read this Use and Care Manual and your cookbook to learn how to fully use and enjoy the oven.

Microwave cooking enables you to cook, reheat, roast, simmer, hold-warm and even defrost with speed and convenience. Because microwave cooking is cool cooking, ovens and dishes are easy to clean. Food is tasty and attractive. Basic cooking techniques are as important when microwave cooking as they are in conventional cooking. These basics are described throughout your cookbook.

Start with something easy; heat a cup of coffee in a mug for 2 minutes; but open the door at any time and check if the coffee is as hot as you like it. Next, try heating leftovers on a dinner plate. An average serving takes about 4-5 minutes; look for

steam or touch the food. Casseroles and vegetables are also easy things to do. Wait until you are comfortable with microwave cooking before you try a roast. Open the door, look and taste the food at any time while cooking so you get the results you like. If additional time is needed, add time gradually; usually about 1/8th of the original time is a good starting point.

Use your cookbook to learn about microwave cooking and use your Use and Care Manual to learn how to operate your oven.

Variable Power

Allows total flexibility in choosing the speed (microwave power) of cooking which will give you the best cooking results for each type of food.

Installation

To install your oven follow these three steps:

- 1) Remove all materials from the oven interior.
- 2) Place the oven in a location of your choice. Make certain that the oven is on a level surface and that there is at least one inch (2.5 cm) of clearance at the top, 2 inch (5 cm) at the back and a total of 6 inches (15 cm) side clearance to ensure proper ventilation. Note: Do not store cookbooks or this instruction manual inside or underneath the oven.
- 3) Make the electrical connection as detailed below.

Electrical connection

Connection must be carried out by qualified personnel in accordance with existing rules and regulations, making sure that the electric network has an efficient earth connection.

These appliances feature a three-pole electric supply cable, having a plug with fuse, and are designed to operate on alternative current, with a single phase voltage of 240V-50Hz.

This Zanussi microwave oven is fitted with a moulded-on 13 amp plug, ready to be plugged straight into an ordinary 13 amp power socket. The only maintenance required is if the fuse needs replacing. To replace, use a 13 amp BS I362 fuse. Only ASTA approved fuses should be used.

If the fuse blows you can replace it in the following way:

Remove the plugs from the power socket and use a small screwdriver to lever out the red plastic fuse carrier located between the plug prongs together with the fuse.

Remove the old fuse and replace it with a new 13 amp ASTA approved fuse and clip the carrier back into the plug. The fuse cover/carrier must be replaced in

the event of changing the fuse. The correct fuse cover-carrier colour is the one shown by the coloured insert at the base of the prong face of the plug. The plug must not be used if the fuse cover/carrier is lost. A replacement cover/carrier can be obtained from your local Zanussi Service Network addresses of which are listed in the enclosed Zanussi Service and Spares Nationwide leaflet.

If the plug is not suitable it must be cut off and the appropriate plug fitted.

The cut off plug should be disposed of to prevent the hazard of electric shocks in case it should be plugged into a 13 amp socket in another part of the house. The flex wires are colour coded as follows:

GREEN AND YELLOW	- EARTH
BLUE	- NEUTRAL
BROWN	- LIVE

Make sure you connect each wire to the correct terminal inside the plug. The plug's terminals may be colour-coded in the same way as the wires. If not, the earth terminal will either be coloured green, green/yellow or be marked with the letter "E" or be marked with the symbol . The neutral terminal will either be coloured black, or be marked with the letter "N". The live terminal will either be coloured red, or be marked with the letter "L".

WARNING

Connecting the supply cable to the mains.

If you require a direct connection to the electric network (mains) or the plug cannot be reached (built in version), it will be necessary to fit between the oven and the mains an omnipole switch, with a minimum aperture between contacts of 3 mm, suitable to carry the required load and conforming to the ruling specifications.

The green & yellow ground wire must not be interrupted by the switch.

Prior to connecting the oven to the electricity supply make sure that:

the protection fuse and the domestic wiring system are suitable to carry the total electric load of the appliance (see rating plate):

the electricity supply network (mains) has an efficient earth connection according to the established rules and existing regulations;

the double pole switch used to connect the appliance to the supply is easily accessible after installation.

The appliance must be earthed

Important: after installation and connecting, the cable must be placed that it cannot at any point reach a temperature more than 50 °C above the ambient temperature.

Warning: For reasons of safety it is strictly forbidden to remove the rear panel to gain access to the oven terminal board; any extension should only be made by using the standardized plug and the external cable, and it should be suitable to carry the expected load.

The manufacturers disclaim any responsibility should these safety instructions not be carried out.

This appliance meets the requirements laid down in EEC Directive No 82/499 dated 7/6/1982 relating to the suppression of radio and TV interference.

Important Facts You Should Know

Safety Precautions

Do Not attempt to operate the oven with the door open by tampering with the safety interlocks.

Do Not place any object between the oven front face and the door or allow the sealing surfaces to accumulate dirt.

Do Not operate the oven if it is damaged in any way.

Do Not attempt to have the oven adjusted or repaired by anyone other than properly qualified personnel.

Do not use metal cookware in the oven.

Cookware

As microwaves heat only the food, it is possible to serve in the same dish you used for cooking. The dish is warmed only slightly through the heat of food. You can cook in almost any type of ceramics except those with gold, silver or platinum decoration. However, it is recommended to use completely baked ceramic dishes.

Any heat-resistant cookware can be used. However, care should be taken when using fragile glassware since abrupt heating and cooling may break them.

Some plastics, such as melamine or urethane, are not recommended because microwaves may warp or crack them through heating by microwaves or conduction of heat from the food. For further information, see your microwave cook book.

Some tips on cooking

The microwave oven cooks much faster than conventional ovens. You will have to rely more on the times than on the appearance because the food is cooked inside and out almost simultaneously. Check the food periodically until you become familiar with this modern way of cooking. Remember the cooking time may require adjusting according to your taste and because the food itself will vary in weight, tenderness and shape.

Features

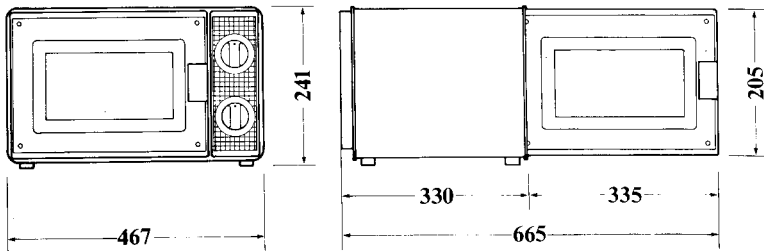
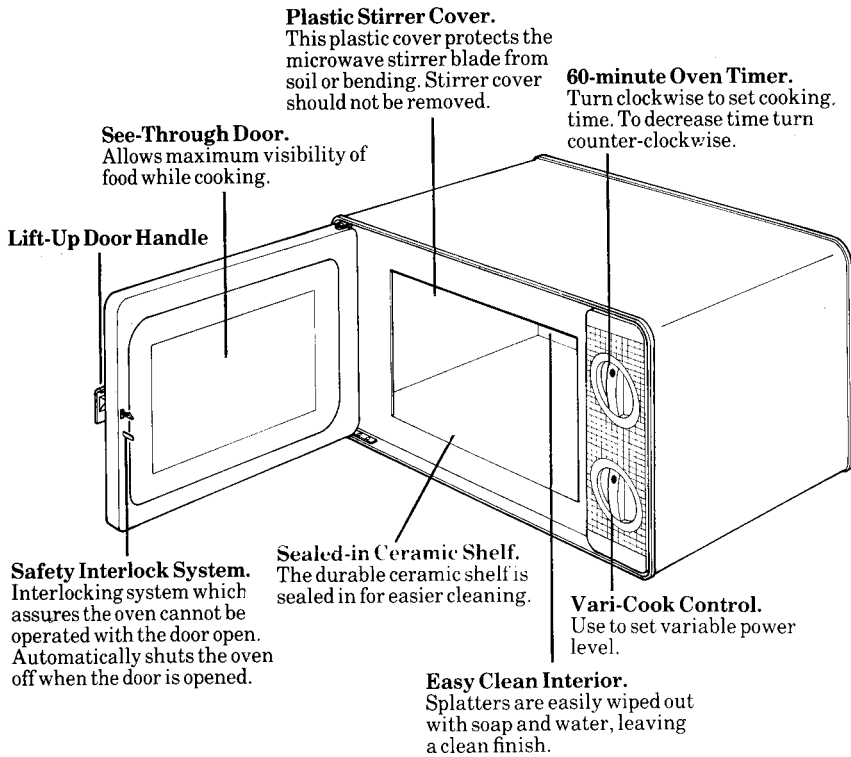

Control Panel

60 MINUTE
TIMER

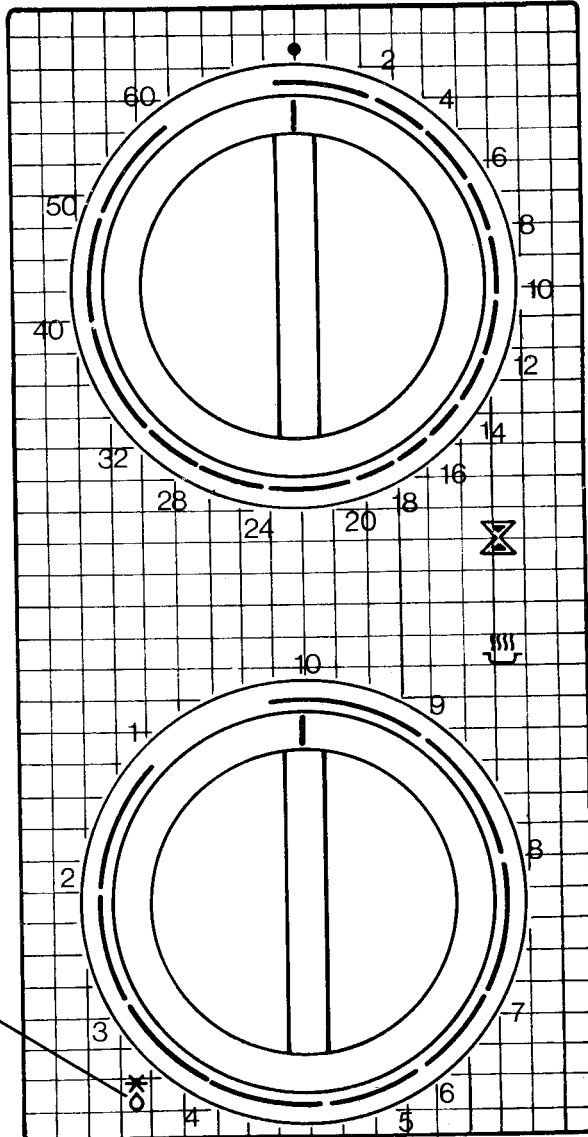

VARIABLE
POWER
CONTROL

DEFROST
SETTING

Using the Microwave Oven

To ensure maximum satisfaction from your microwave oven we would like to advise you of some precautions to observe when using your new microwave cooking appliance.

Before using for the first time be sure that all packing materials are removed.

Do Not use the oven for storage when it is not in use.

Do Not attempt to run the oven with no food in it.

Do Not let the timer continue to operate after removing a food, return the timer to zero.

Do Not attempt to cook or reheat eggs in the shell in the microwave oven: they may explode.

Above all, this is a cooking appliance designed to prepare food. Whilst microwave ovens do not generate heat to cook food, the food item and possibly the container may become hot. Therefore precautions that are taken with conventional cooking should also be observed when cooking with microwaves.

CARE SHOULD ALSO BE TAKEN WHEN REHEATING ITEMS WITH A HIGH SUGAR CONTENT.

When reheating small items such as mince pies, take care to underestimate reheating times rather than overestimate.

Example

2 mince pies on '8' 20-30 seconds only.

As the microwave oven cooks so much faster than a conventional oven it is wise to take especial care when you are cooking something for which specific timings have not been recommended. This applies particularly when reheating foods.

Always watch the cooking or heating of the food in question, giving it short cooking times and adding more until you have obtained the desired result. You will soon learn the correct timings for cooking or heating your favourite foods. It is important to remember that it is possible to burn foods if they are cooked for too long.

Tips on Using the Microwave Oven

- Be sure to carefully read your cook book and become familiar with the results to expect.
- Always start with the minimum cooking time given in the book and add time as needed to obtain the results desired. Each recipe gives you a suggested cooking time and indication of result. Use the cooking time as a guide and follow the cooking test carefully.
- The door can be opened any time during the cooking operation; the oven will automatically stop cooking and the time setting will maintain until the door is closed.
- A microwave oven is used for defrosting, heating or cooking foods. It should not be used for such things as canning, cooking or reheating hard cooked eggs with or without the shell. Great care should be taken when drying non food items such as flowers and herbs.
- Be sure to read each recipe carefully as dish size, arrangements, stirring, and standing time are important in obtaining good results.

Oven Operation

The Variable Power Feature

Variable power includes settings from 100% or full power to 10%. The 100% setting provides the greatest speed of microwave cooking. The settings between 100% and 10% represent decreasing amounts of microwave speed.

This feature gives you total flexibility in choosing the speed (or microwave power) of cooking which will give you the best result for each type of food. As with conventional cooking, some foods require slower or more gentle microwave cooking. Other foods need to cook slower so heat from the outside has enough time to conduct into the centre of the food.

Variable Power gives you the flexibility to choose the microwave speed that is right for the food you're cooking.

Basic uses are as follows:

Setting:

- 1 **-10% WARM**
Holding food warm.
- 2 **-20% LOW**
Softening cheese and butter, raising bread, holding food warm.
- 3 **-30% DEFROST**
- 4 **-40% MED LOW**
Warming syrups and sauces.
- 4 **-50% BRAISE**
For cooking less tender foods slowly.
- 6 **-60% SIMMER**
Stews and soup, to start quick breads and cakes.
- 7 **-70% BAKE**
Heating frozen main meal dishes, e.g. fish pies, curries, casseroles.
- 8 **-80% ROAST**

9 **-90% REHEAT**

Reheating precooked foods and leftovers.

10 **-100% HIGH**

Full power for vegetables, fish, hot beverages, grill, preheating microwave browner.

Operating with Time & Variable Power

Each recipe in the cookbook gives the approximate cooking time. Start with the shorter time and add time if needed. The cookbook is only a guide, as food temperature and density can vary the time.

1. Pull up door handle. Interior light comes on automatically when door opens.
2. Place food item inside oven.
3. Set the appropriate power setting for your food (see cookbook).
4. Set timer for desired time by turning clockwise.
5. Close door. Oven will start cooking (the door may be opened at any point to check food even if time is left on the dial. The timer will maintain the time setting and cooking will continue when door is reclosed).
6. When the time is up, a bell rings once and the oven shuts off automatically.

Cleaning & Maintenance

Microwave Oven Cleaning

Your microwave oven requires a minimum of maintenance. To keep it free from grease and soil build-up, the microwave oven should be cleaned with a damp cloth after each use. A soft nail brush can be used to remove stubborn stains. Odours can be eliminated from the inside of the oven by boiling a solution of one cup of water and several tablespoons of lemon juice in the cavity. This also helps in loosening any soil which has dried on the oven. We would also recommend occasionally wiping the oven interior with a sterilizing fluid, ie Milton, in the interest of hygiene.

Use only a mild detergent, water and a soft clean cloth to clean the oven face and exterior surfaces. Be careful not to scratch the door and interior surface. Wipe out excess moisture after each use.

Ceramic cleaners can be used to clean the shelf.

Do Not Use: Abrasive cleaners, cleaning pads or steel wool.

Oven Should Not Be Used For Storage

Be sure the oven is cleaned carefully after every use and is not used for storage of paper products, books or cooking utensils.

Replacement of Oven Interior Light

The oven interior light bulb is easily replaced. First, unplug the oven. Then, simply unsnap and remove the "Lamp Access Cover" on the back of the oven. In some models, a screw must first be removed to remove the cover. Replace bulb with a 15-watt lamp (E-14) available from a hardware store or local Zanussi service agent.

Lamp Access Panel

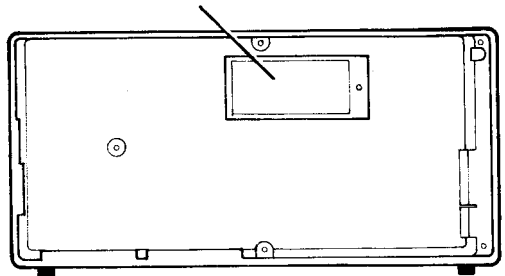

Questions and Answers

- Q.** What happens if I accidentally operate the microwave oven with no food in it?
- A.** While such accidental use of short periods of time does not damage the magnetron, it is not recommended.
- Q.** Is eating food cooked in a microwave oven harmful?
- A.** Microwaves are simply a source of heat energy just like gas and electricity. All three produce cooking in the food itself. Food cooked in a microwave oven is not harmful to eat.
- Q.** Why do I have moisture in the microwave oven after cooking?
- A.** The moisture on the inside of your microwave oven is normal and nothing to worry about. It is caused by the steam from the cooking food hitting a cool oven surface. Wipe excess moisture from inside of oven after each use.
- Q.** What causes the oven interior light to dim when using Variable Power?
- A.** This is normal and indicates that the oven is operating and cycling normally.
- Q.** Foods cooked in a microwave oven seem to cool off faster than conventionally cooked foods. Why is that?
- A.** Often the dish used to store foods in the refrigerator is used for heating in the microwave oven. In this case, the cold dish absorbs heat from the food. It may be necessary to heat the food for additional time.

What happens if something goes wrong

Important:

If the oven does not come on:

check that the appliance is connected correctly;
check that the switch from the supply to the appliance is ON;
replace the fuse in the socket, where present, with another of the appropriate rating;
check that the fuse in the fuse box is intact.

If after all these checks the appliance still does not work, call your local Zanussi Network service centre listed in the telephone directory. It helps to jot down the address and telephone number in the space below.

Never attempt to remove the rear panel of the oven or tamper with the oven in any way.

Important: UNDER NO CIRCUMSTANCES SHOULD ANY SERVICE REPAIR WORK BE CARRIED OUT ON THIS APPLIANCE BY UNQUALIFIED PERSONS.

Peace of mind for twelve months

ZANUSSI STANDARD GUARANTEE CONDITIONS

This guarantee is in addition to your statutory and other legal rights which will not be excluded or in any way diminished by the return of this guarantee card.

We, Zanussi Limited, guarantee that if within twelve months of the date of the purchase, this ZANUSSI appliance or any part thereof is proved to be defective by reason only of faulty workmanship or materials we will at our option repair or replace the same **FREE OF ANY CHARGE** for labour, materials or carriage on condition that:

–The appliance has been correctly installed and used only on the electricity supply stated on the rating plate.

–The appliance has been used for normal domestic purposes only, and in accordance with the manufacturer's operating and maintenance instructions.

–The appliance has not been serviced, maintained, repaired, taken apart or tampered with by any person not authorised by us.

–The appliance is still in the possession of the original purchaser.

All service work under this guarantee must be undertaken by a Zanussi Network Service Centre (or the Zanussi Authorised TV Service Dealer).

Any appliance or defective part replaced shall become our property.

Exclusions

This guarantee does not cover:

–Damage or calls resulting from transportation, improper use or neglect, the replacement of any light bulbs or removable parts of glass or plastic.

–Cost incurred for calls to put right machines improperly installed or calls to machines outside the UK and the Republic of Ireland.

–Appliances found to be in use within a commercial environment, plus those which are the subject of rental agreements.

–Television receivers – routine adjustment, or poor reception resulting from a source outside of the receiver.

or five years

ZANUSSI 5 YEAR COVER CONDITIONS

For a once-only payment you can extend your Standard Guarantee to 5 years. All the conditions and exclusions of the Standard Guarantee apply.

Notes

1. Products supplied as 'seconds', refurbished, damaged or shop-soiled are not eligible for Zanussi 5 Year Cover.
2. The issue of a cover does NOT by virtue of our having done so, nullify the exclusions.

3. The Engineer will need to check the details of your Cover card and may make a charge for his services if it is not presented to him at the time of his call.

4. The date of purchase, or the date of initial payment (deposit) of the appliance will be deemed the date of commencement of cover.

5. Covers issued are not refundable or transferable.

Guarantee Record

Appliance purchased from _____ on _____
Guarantee card no _____ Model no _____
Serial no _____ (These details may be
Your name _____ taken from your
Address _____ Guarantee Record Card)

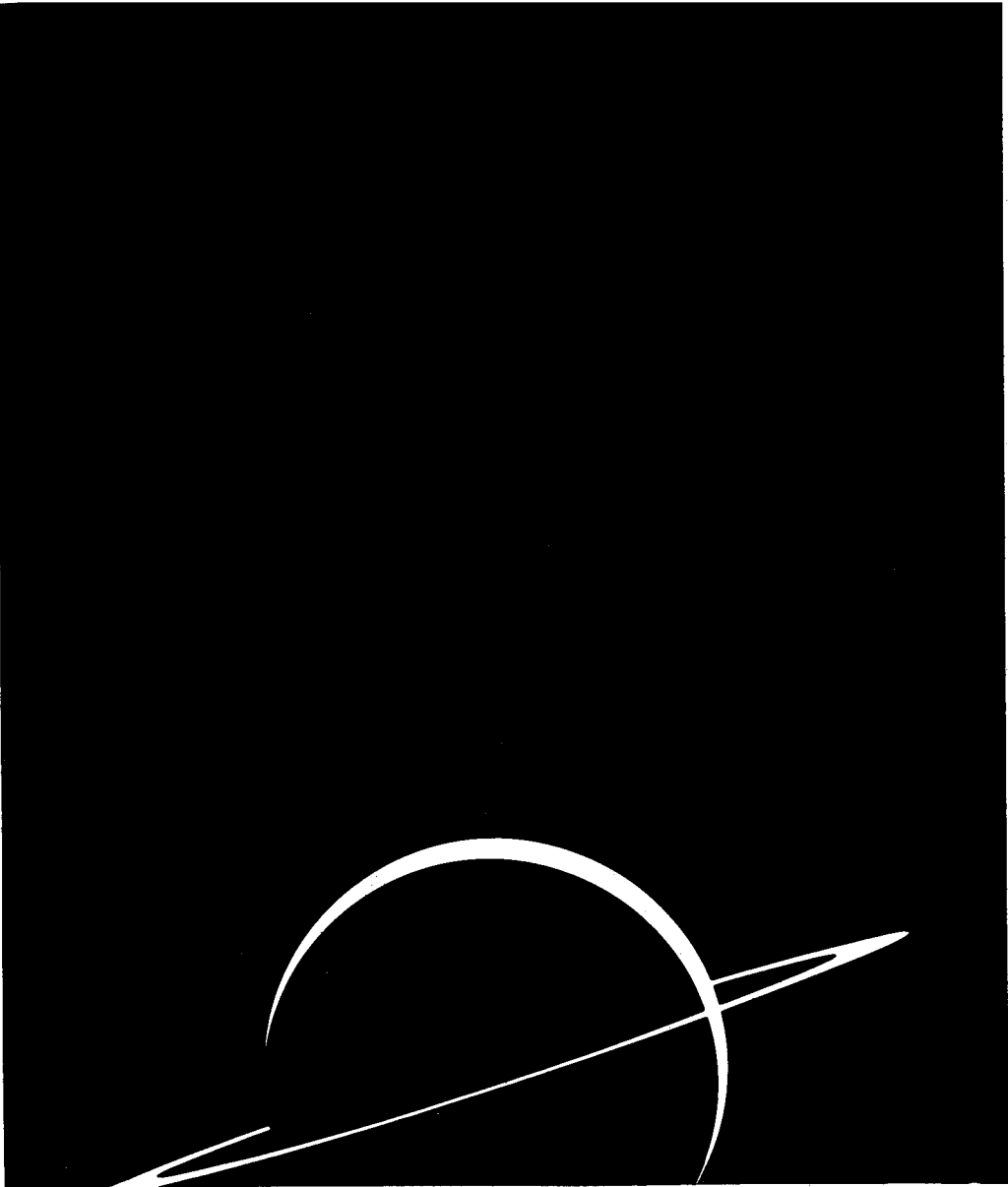

ZANUSSI

The appliance of science

Zanussi Limited, Zanussi House, Hambridge Road, Newbury.

The information in this manual is correct at time of going to press.
Zanussi reserve the right to alter specifications without notice.

R1132

Free Manuals Download Website

<http://myh66.com>

<http://usermanuals.us>

<http://www.somanuals.com>

<http://www.4manuals.cc>

<http://www.manual-lib.com>

<http://www.404manual.com>

<http://www.luxmanual.com>

<http://aubethermostatmanual.com>

Golf course search by state

<http://golfingnear.com>

Email search by domain

<http://emailbydomain.com>

Auto manuals search

<http://auto.somanuals.com>

TV manuals search

<http://tv.somanuals.com>