

ZANUSSI

BUILT-IN OVEN
INBYGGNADSUGN

ZBS 773

INSTRUCTION BOOKLET
BRUKSANVISNING

Important Safety Information



You MUST read these warnings carefully before installing or using the oven.
If you need assistance, contact our Customer Care Department
on 01635 521313

Installation

- This oven must be installed by qualified personnel to the relevant British Standards.
- This oven is heavy. Take care when moving it.
- Remove all packaging, both inside and outside the oven, before using the oven.
- Do not attempt to modify the oven in any way.

Child Safety

- This oven is designed to be operated by adults. Do not allow children to play near or with the oven.
- The oven gets hot when it is in use. Children should be kept away until it has cooled.

During Use

- This oven is intended for domestic cooking only. It is not designed for commercial or industrial purposes.
- Never line any part of the oven with aluminium foil.
- Do not allow heatproof cooking material, e.g. roasting bags, to come into contact with oven elements.
- Never place plastic or any other material which may melt in or on the oven.
- Do not place sealed cans or aerosols inside the oven. They may explode if they are heated.
- Do not hang towels, dishcloths or clothes from the oven or its handle.
- Do not use this oven if it is in contact with water and never operate it with wet hands.
- Take great care when heating fats and oils as they will ignite if they become too hot.
- Always use oven gloves to remove and replace food in the oven.

- Ensure that all control knobs are in the OFF position when not in use.
- Do not leave cookware containing foodstuffs, e.g. fat or oil in or on the oven in case it is inadvertently switched ON.
- When using other electrical appliances, ensure the cable does not come into contact with the hot surfaces of the oven.

Maintenance and Cleaning

- Only clean this oven in accordance with the instructions.
- The oven should be kept clean at all times. A build-up of fats or other foodstuffs could result in a fire, especially in the grill pan.
- Always allow the oven to cool down and switch off the electrical supply before carrying out any cleaning or maintenance work.

Service

- This oven should only be repaired or serviced by an authorised Service Engineer and only genuine approved spare parts should be used.

Environmental Information

- After installation, please dispose of the packaging with due regard to safety and the environment.
- When disposing of an old appliance, make it unusable, by cutting off the cable. Remove any door catches, to prevent small children being trapped inside.

Keep this instruction book for future reference and ensure it is passed on to any new owner.

Contents

For the User

Important Safety Information	Page	3	Defrosting	Page	19
Description of the Oven	Page	5	Grilling	Page	20
Control Panel	Page	6	Pizza Oven	Page	23
How to set the Time of Day	Page	7	Baking Function	Page	23
How to select a Cooking Function and Temperature	Page	8	Cleaning the Oven	Page	24
"Fast Heat Up" Function	Page	9	Replacing the Oven Light	Page	26
Defrost Function	Page	9	Cleaning the hinged grill	Page	26
Before the First Use	Page	10	If something goes wrong	Page	27
Using the Oven	Page	10	Peace of Mind for 24 Months	Page	28
Telescopic runners	Page	11	Service and Spare Parts	Page	28
Programming the Oven	Page	12			
Safety and Energy Saving Functions	Page	13			
Safety Cut-Off Function	Page	14			
Child Safety Function	Page	14			
Residual Heat Function	Page	14			
The Fan Oven	Page	15			
The Conventional Oven	Page	17			
Cooking Chart - Fan and Conventional Oven	Page	18			

For the Installer

Installation	Page	29
Electrical Connection	Page	29
Building In	Page	30

Guide to use the instructions

The following symbols will be found in the text to guide you throughout the Instructions:



Safety Instructions



Step by step instructions for an operation



Hints and Tips

CE This appliance complies with the following E.E.C. Directives:
* 73/23 - 90/683 (Low Voltage Directive);
* 93/68 (General Directives);
* 89/336 (Electromagnetic Compatibility Directive) .
and subsequent modifications

Description of the Oven

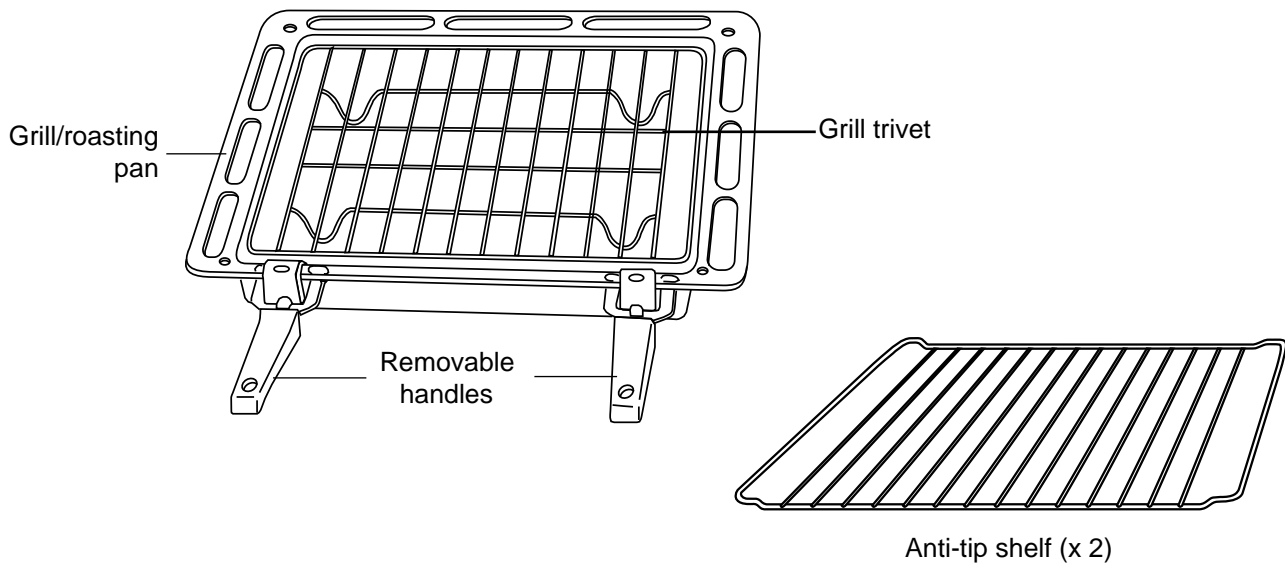
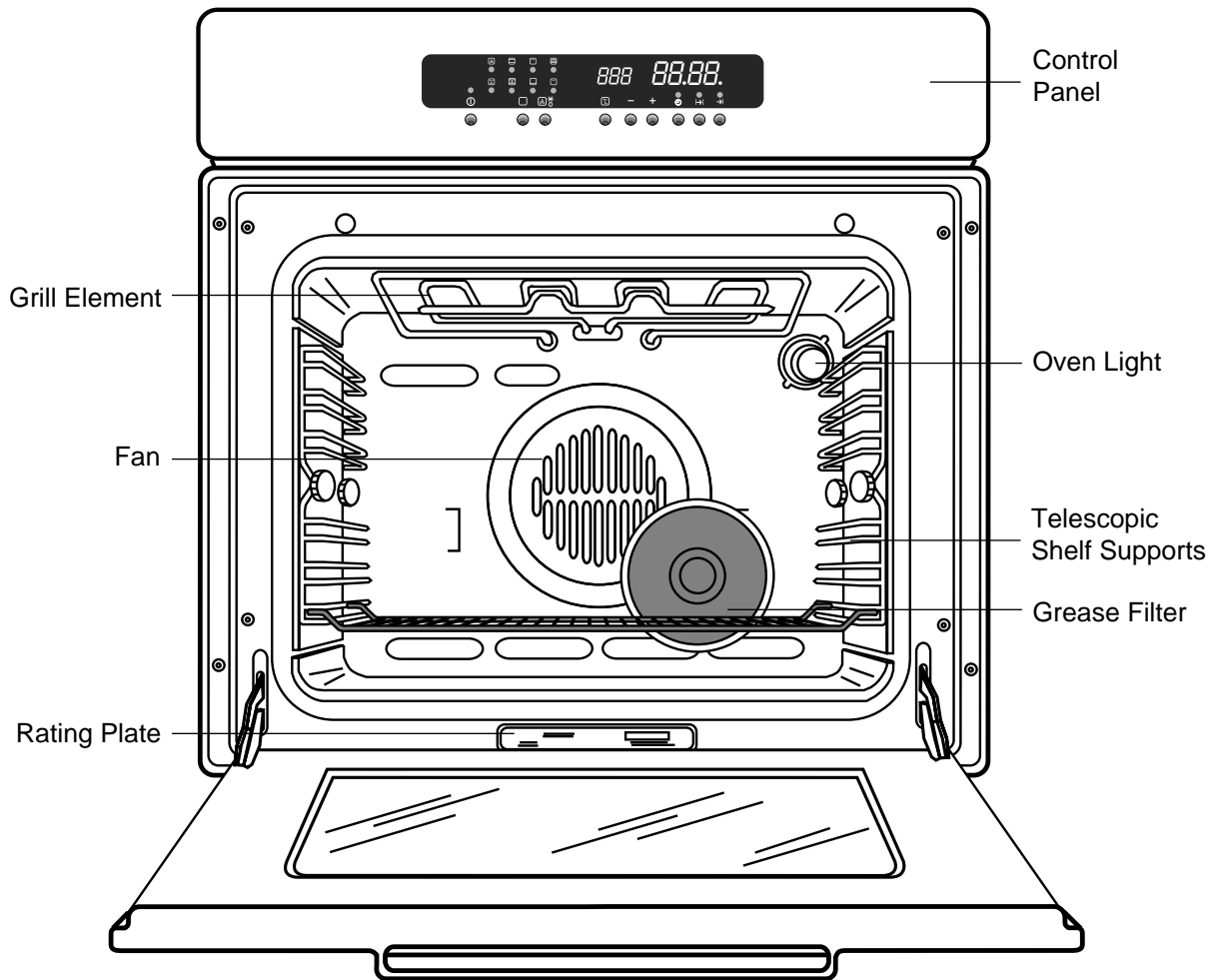

Control Panel

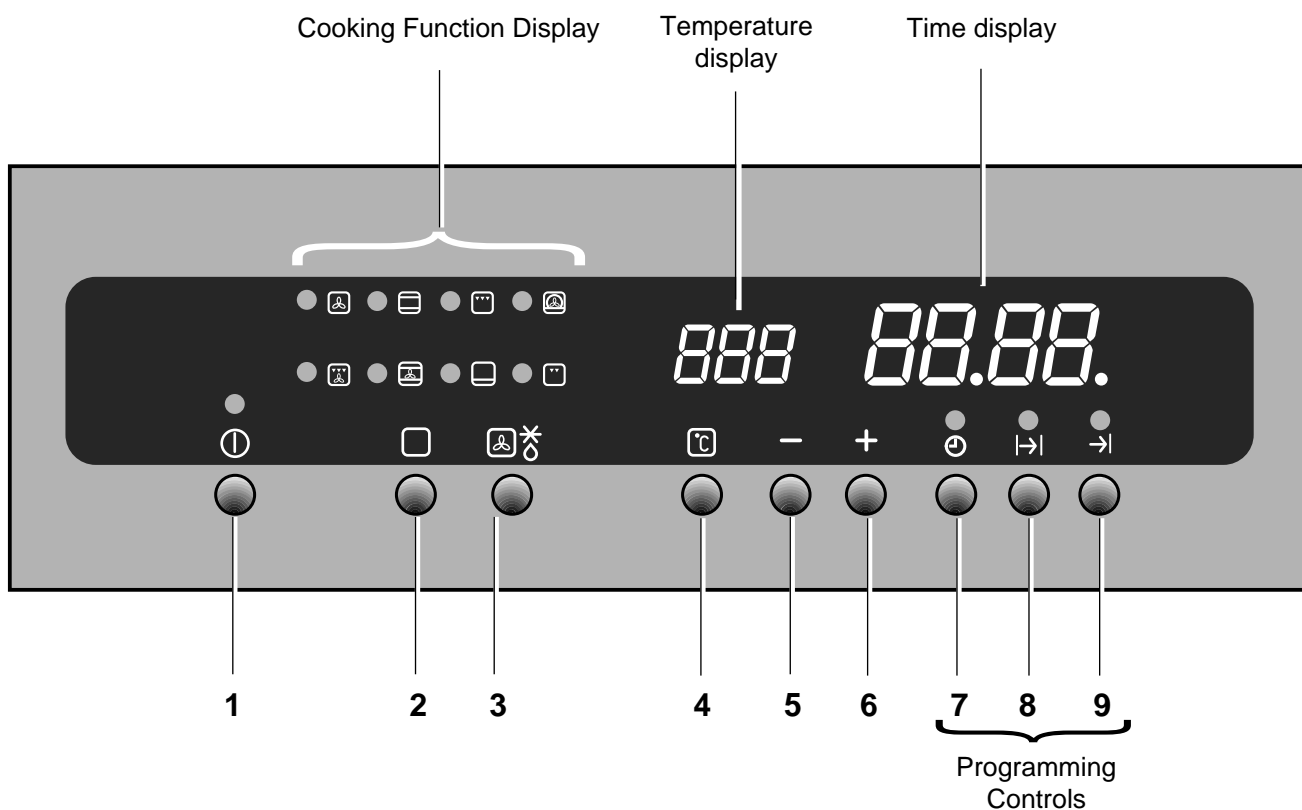

Push Buttons

1. ON / OFF
2. Oven Function Control
3. Fast Heat Up / Defrost Function
4. Temperature Control / Current Temperature
5. Decreasing Control (Time or Temperature)
6. Increasing Control (Time or Temperature)
7. Minute Minder
8. Cooking Time
9. End of Cooking Time

All the oven functions are controlled by an electronic programmer.

You can select any combination of cooking function, cooking temperature and automatic timing.

i In the event of a power failure, the programmer will keep all the settings (time of day, program setting or program in operation) for about 10 minutes. If power is not restored within 10 minutes, all the settings will be cancelled. When the power is restored, the numbers on the display will flash, and the clock/timer has to be reset.

"On/Off" Push Button

The oven must be switched on before setting any cooking function or programme. When button  is pressed, the pilot light above will come on, and the oven light will switch on.

To switch off the oven, you can press button  at any time. Any cooking function or programme will stop, the oven light will switch off and the time display will show the time of day only.



When button  is pressed, the display will show the current internal temperature if the oven has not completely cooled down.

Oven Function Control Push Button

Push button  allows you to select the cooking function. Each time you push this button, a pilot light will come on in the Oven Function Display, showing what cooking function has been chosen.

Increase and Decrease Push Buttons

Push buttons “-” and “+” allow you to increase or decrease temperature or time settings.

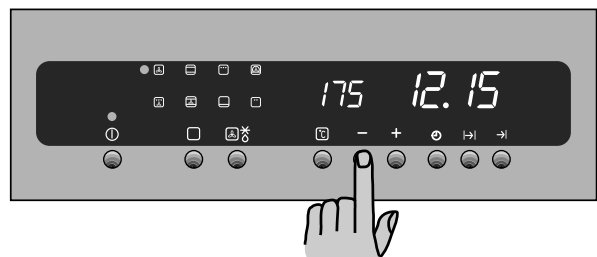

How to set the Time of Day

The oven has a 24 hour clock.

When the oven is first connected to the electrical supply, the display will automatically show 12:00.

If no button is pressed within 10 seconds, the numbers will stop flashing and the clock will start running from 12.00.



To set the correct time of day :

If numbers are flashing:







press button “-” or “+”. When the correct time is displayed, confirm the setting by pressing button . The clock will start running.



If numbers are static:



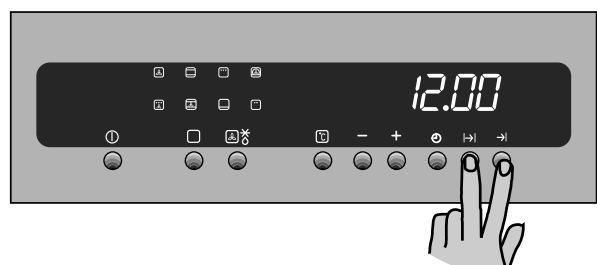

press buttons  and  at the same time and keep them pressed until the numbers start flashing. Release buttons  and , then adjust the time by pressing buttons “-” or “+” and confirm by pressing button .



How to select a Cooking Function and Temperature

The oven has 8 different cooking functions. For each of them, a pre-set temperature will be automatically selected.

- 1) Switch on the oven by pressing the "ON" button.
- 2) Press button  to select the required oven function. Each time button  is depressed, a pilot light will come to the left of the currently selected cooking function symbol.
- 3) If the pre-set temperature is not suitable, press button “-” or “+” to adjust the temperature in 5 degree steps. When the required temperature is reached an acoustic alarm will sound for a short time.

You can also get the current internal temperature by pressing button  once.



If the internal temperature is higher than the selected temperature (e.g. when a cooking function has been completed and the oven is still hot) the internal temperature will not be displayed.

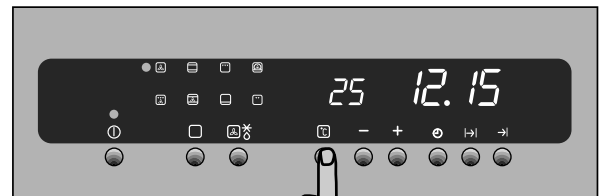
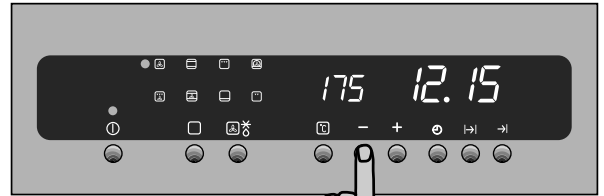
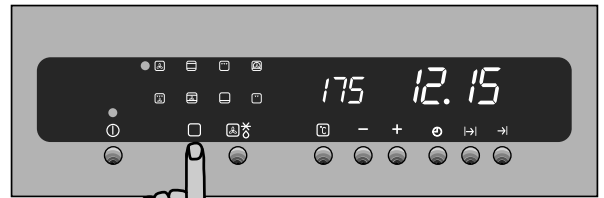

Cooking Function Symbols



Fan cooking - This setting allows you to roast or roast and bake simultaneously using any shelf, without flavour transference.



Conventional cooking - The heat comes from both the top and bottom element, ensuring even heating inside the oven.



Full Grill - The full grill element will be on. Recommended for large quantities.



Pizza Oven - The bottom element provides direct heat to the base of pizzas, quiches or pies, while the fan ensures air is circulated to cook the pizza toppings or pie fillings.



Thermal Grilling - This function offers an alternative method of cooking food items, normally associated with conventional grilling. The grill element and the oven fan operate together, circulating hot air around the food. **Select a maximum temperature of 200°C.**



Baking Function - The top and bottom elements heat the oven cavity and the fan circulates hot air around your dishes. Best for baking cakes, biscuits or bread.



Bottom heating element - The heat comes from the bottom of the oven only, to allow you finish your dishes.



Inner grill element only - can be used for grilling small quantities.

"Fast Heat Up" function

After a cooking function has been selected and the temperature has been adjusted, the cavity will gradually heat up until the selected temperature is reached. This will take from 10 to 15 minutes, depending on selected function and temperature. If it is necessary to reach the required temperature in a shorter time, the "Fast Heat Up" Function can be used.

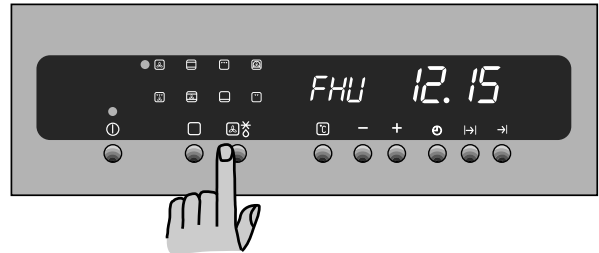

- 1) Switch the oven on by pressing button 1.
- 2) Set the required cooking function and temperature as explained in the previous pages.
- 3) Press button  once. The temperature display will show "FHU".
- 4) When the required temperature is reached, an acoustic alarm will sound for a short time, and the temperature display will revert to the set temperature.

This function can be used with any cooking function or temperature.



Defrost Function

It is possible for the oven fan to operate without heat and circulate the air, at low temperature, inside the oven. This increases the speed of defrosting.

- 1) Switch the oven on by pressing button 1.
- 2) Press button  twice. The temperature display will show "32". This temperature setting cannot be changed.
- 3) To switch the "defrost" function off, just press button  once again. The oven will switch off, and the display will only show the time of day.

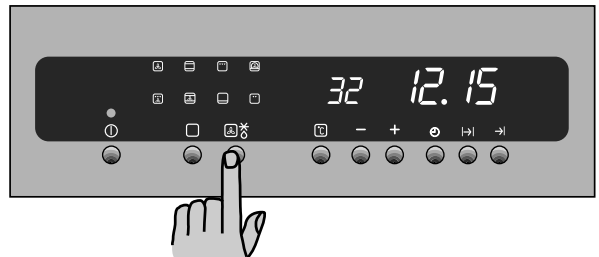

This function is particularly suitable for defrosting delicate food which could be damaged by heat, e.g. cream filled gateaux, iced cakes, pastries, bread and other yeast products. (See details on page 19).



Before the First Use





Remove **all packaging**, both inside and outside the oven, before using the oven.

Before first use, the oven should be heated without food. During this time, an unpleasant odour may be emitted. This is quite normal.



1. Switch on the oven by pressing the "ON" push button.
2. Press button  twice. The pilot light to the left of symbol  will come on.
3. Set the temperature to 250°C using the "Increase" button (push button "+").
4. Open a window for ventilation.
5. Allow the oven to run empty for approximately 45 minutes.

This procedure should be repeated with the full grill function  and the fan oven function  for approximately 5-10 minutes.

Using the Oven



- **Always cook with the oven door closed.**
- Stand clear when opening the drop down oven door. **Do not** allow it to fall open - support the door using the door handle, until it is fully open.



- The oven has six shelf levels, and is supplied with two shelves. The shelf positions are counted from the bottom of the oven as shown in the diagram. It is important that these shelves are correctly positioned as shown in the diagram.
- Do not place cookware directly on the oven base.

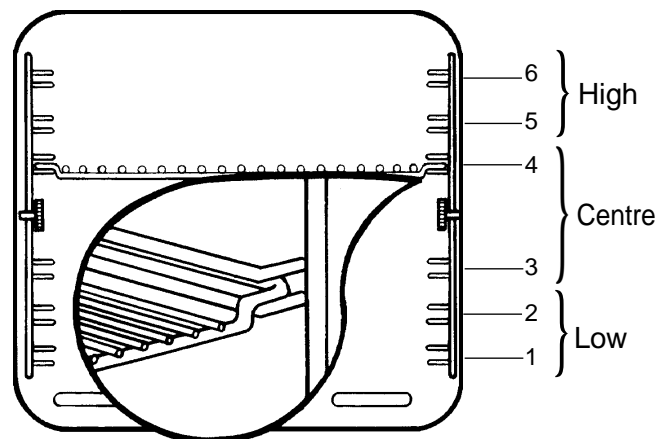

i Hints and Tips

Condensation and steam

When food is heated it produces steam in the same way as a boiling kettle. The oven vents allow some of this steam to escape. However, **always stand back from the oven when opening the oven door** to allow any build up of steam or heat to release.

If the steam comes into contact with a cool surface on the outside of the oven, e.g. a trim, it will condense and produce water droplets. This is quite normal and is not a fault with the oven.

To prevent discoloration, regularly wipe away condensation and also soilage from surfaces.

Cooling fan

The cooling fan operates during cooking. Air is expelled through vents between the oven door and the control panel, as shown in the diagram.

The cooling fan may run on after the oven is switched off to keep the controls cool. This is quite normal.

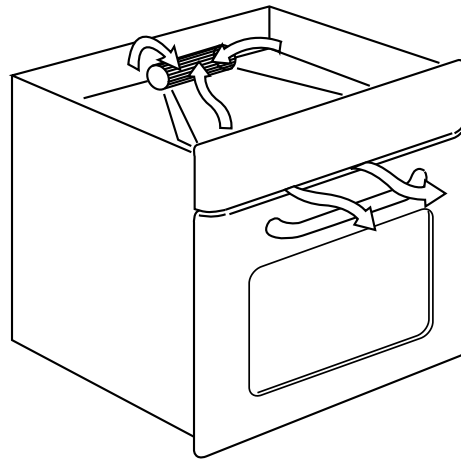

Cookware

- Use any oven proof cookware which will withstand temperatures of 250°C.
- Baking trays, oven dishes, etc. should not be placed directly against the grid covering the fan at the back of the oven, or placed on the oven base.
- Do not use baking trays larger than 30 cm x 35 cm (12 in x 14 in) as they will restrict the circulation of heat and may affect performance.

The effects of dishes on cooking results

Dishes and tins vary in their thickness, conductivity, colour, etc. which affects the way they transmit heat to the food inside them.



- A** Aluminium, earthenware, oven glassware and bright shiny utensils reduce cooking and underneath browning.
- B** Enamelled cast iron, anodized aluminium, aluminium with non-stick interior and coloured exterior and dark, heavy utensils increase cooking and underneath browning.

Programming the Oven

How to set the minute minder

- 1) Press button  to select the Minute Minder Function. The relevant pilot light will flash and the control panel will display 0.00.
- 2) Press button “-” or “+” within 3 seconds to select the required time (up to 19 hours 59 minutes). The Minute Minder will wait 3 seconds and then start running.
- 3) The display will count down the programmed time in minutes.
- 4) When the programmed time has elapsed, an acoustic alarm will be heard, and 0.00 will flash on the control panel. The oven will **NOT** switch off if in use.
- 5) To switch off the acoustic alarm, press any button. The control panel will display the time of day and the Minute Minder pilot light will go out.



To cancel the Minute Minder:

-  press button  and, while keeping it pressed, press button “-” too. The display will show 0.00.

To programme the Oven to switch off

- 1) Place food in the oven, select a cooking function and adjust the cooking temperature if required.
- 2) Press button  to select the Cooking Duration function. The Cooking Duration pilot light will flash and the control panel will display 0.00.
- 3) Press button “-” or “+” to select the required time (up to 19 hours 59 minutes). The programmer will wait 3 seconds and then start running.
- 4) The display will count down the programmed time in minutes.
- 5) When cooking time is over, the oven will be switched off automatically and an acoustic alarm will be heard, while 0.00 will flash on the control panel.
- 6) To switch off the acoustic alarm, press any button. The control panel will display the time of day and the Cooking Duration pilot light will go out.

To cancel the Duration Time:



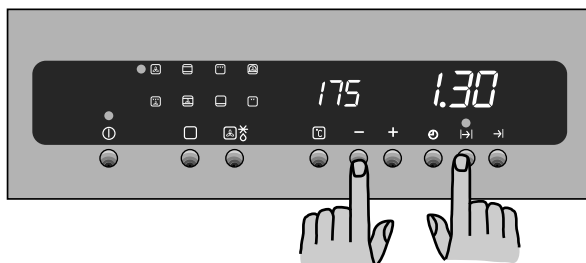
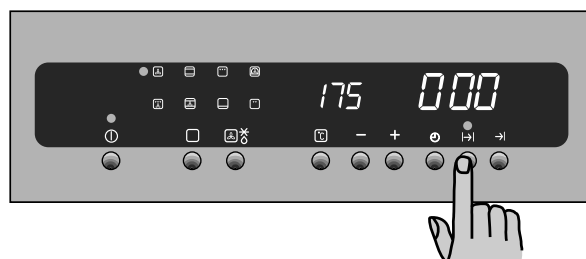
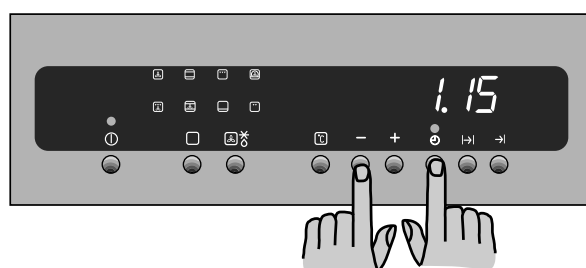
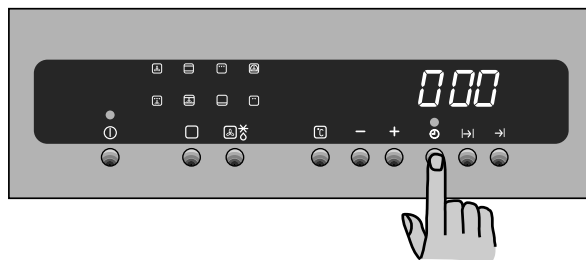

-  press button  and, while keeping it pressed, press button “-” too.
- If this operation is carried out while a program is running on, the oven will NOT switch off.**



i When a Cooking Duration time is set, the oven will switch off a few minutes before the end of the programmed time, and use the residual heat. See “Safety and Energy Saving Functions”.

To programme the Oven to switch on and off



- 1) Carry out the cooking duration setting as described in "To programme the Oven to switch off".
- 2) Press button . The "End of Cooking" function will be selected, and the relevant pilot lamp will flash. The control panel will display the end of cooking time (that is, the actual time + cooking duration).
- 3) Press button "" or "" within 3 seconds to select the required end of cooking time.
- 4) The programmer will wait 3 seconds, then the cooking duration time will appear on the control panel. When the oven switches on, the display will count down the programmed time in minutes.
If you press button  the display will show the end of cooking time.
- 5) The oven will switch on and off automatically. The end of cooking will be marked by an acoustic alarm.
- 6) To switch off the acoustic alarm, press any button. The control panel will display the time of day and the pilot lamps will go off.

To cancel the programme, simply cancel the Duration Time.

Press button  and, while keeping it pressed, press button "" too.



If this operation is carried out while a program is running on, the oven will NOT switch off.

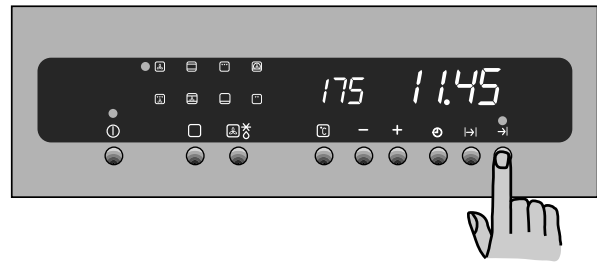

Safety and Energy Saving Functions

Safety Cut-Off Function

If no changes are made to the oven settings, the oven will switch off automatically according to the following table:

If temperature setting is:	the oven will switch off:
250°C or more	after 1 1/2 hours
from 120 up to 250°C	after 5 hours
less than 120°C	after 12 hours

Child Safety Function

To avoid children switching on the oven, it is possible to lock the oven controls.

- 1) Turn off the oven by pressing button ①
- 2) Press buttons  and “—” at the same time and keep them pressed for about 3 seconds. A flashing dot will be displayed after the time of day.
- 3) The oven is now locked. Neither oven functions nor temperatures can be selected.

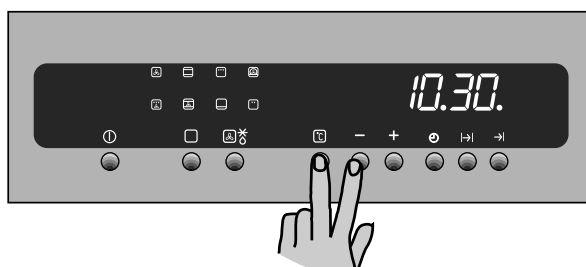

To unlock the oven:

- 1) Press buttons  and “—” at the same time and keep them pressed for about 3 seconds. The flashing dot will go off. The oven can now be operated.

Residual Heat Function

When a Cooking Duration time is set, the oven will automatically switch off a few minutes before the end of the programmed time, and use the residual heat to finish your dishes without energy consumption. The oven pilot light will remain on until the Cooking Duration time is over.

This function will not operate when the Cooking Duration time is less than 15 minutes.

The Fan Oven

The air inside the oven is heated by the element around the fan situated behind the back panel. The fan circulates hot air to maintain an even temperature inside the oven.

The advantages of cooking with this function are:

✓ Faster Preheating

As the fan oven quickly reaches temperature, it is not usually necessary to preheat the oven although you may find that you need to allow an extra 5-7 minutes on cooking times. For recipes which require higher temperatures, best results are achieved if the oven is preheated first, e.g. bread, pastries, scones, souffles, etc.

✓ Lower Temperatures

Fan oven cooking generally requires lower temperatures than conventional cooking. Follow the temperatures recommended in the chart at page 18. Remember to reduce temperatures by about 20-25°C for your own recipes which use conventional cooking.

✓ Even Heating for Baking

The fan oven has uniform heating on all runner positions. This means that batches of the same food can be cooked in the oven at the same time. However, the top shelf may brown slightly quicker than the lower one.

This is quite usual. There is no mixing of flavours between dishes.

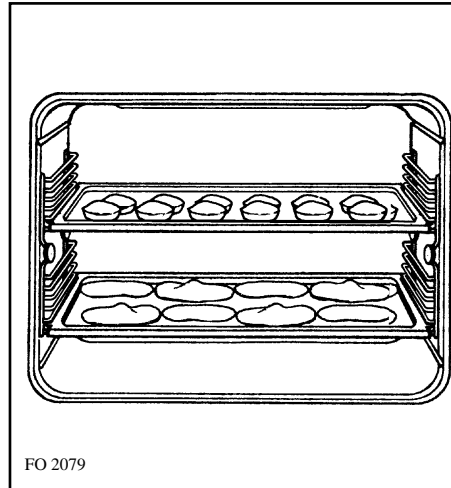

1. Switch the oven on.
2. Press the Oven Function Control button once.
3. If necessary adjust temperature setting using the "Increase" or "Decrease" buttons.

THINGS TO NOTE

- The oven light will come on when the oven is switched on.
- The cooling fan will operate continually during cooking. It may run on after the oven is switched off to keep the controls cool. This is quite normal.

NOTE

The action of the cooling fan will depend on how long the oven has been used and at what temperature. It may not switch on at all at lower temperature settings nor run on where the oven has only been used for a short time.

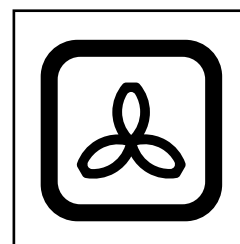

FAN OVEN FUNCTION SYMBOL
PRE-SET TEMPERATURE: 175°C
TEMPERATURE SELECTION: 50°C - 250°C

i Hints and Tips

Runner positions are not critical, but make sure the shelves are evenly spaced.

When cooking more than one dish in the fan oven, place dishes centrally on the shelves rather than several dishes on one shelf.

When the oven is full, you may need to allow a slightly longer cooking time.

A shelf may be placed on the floor of the oven. Place dishes on a shelf in this position rather than on the oven base, to allow air circulation around the food.

When the oven is full of the same food, e.g. equal trays of small cakes or equal size victoria sandwich cakes, then they will be cooked in the same time and removed from the oven together. When different sizes of trays or types of food, e.g. biscuits and cakes are cooked, they will not necessarily be ready together.

The fan oven can be used to heat foods through without thawing first, e.g. fruit tarts, mince pies, sausage rolls, and other small pastry items. Use a temperature of 190-200°C and allow 20-40 minutes (depending on the quantity of food in the oven).

The use of too high temperatures can cause uneven browning. Check with the recommendations for oven temperatures given in the cooking charts, but be prepared to adjust the temperature by 10°C if necessary. Remember to reduce temperatures by about 20-25°C for your own conventional recipes.

The meat tin **should not** be placed on a heated hotplate or burner as this may cause the enamel to crack.

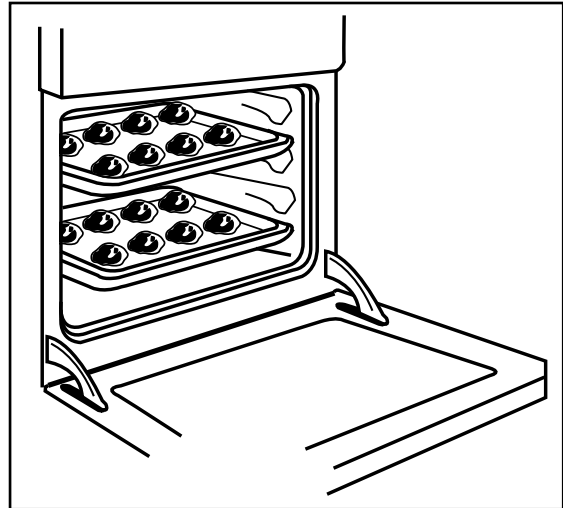

The Conventional Oven

When using this setting, heat comes from both the top and bottom elements. This allows you to cook on a single level and is particularly suitable for dishes which require extra base browning such as quiches and flans.

Gratins, lasagnes and hotpots which require extra top browning also cook well in the conventional oven. This form of cooking gives you the opportunity to cook without the fan in operation.

How to Use the Conventional Oven

1. Switch the oven ON.
2. Select the Conventional Oven Function by pressing the Oven Function control button until the pilot light to the left of symbol  comes on.

Bottom oven element only

This function is particularly useful when blind-baking pastry. It may also be used to finish off quiches or flans to ensure the base pastry is cooked through.

Pre-set temperature is 250°C.

THINGS TO NOTE

During cooking, the cooling fan will operate in the same way as described for the fan oven function.

Hints and Tips

The middle shelf position allows for the best heat distribution. To increase base browning simply lower the shelf position. To increase top browning, raise the shelf position.

The material and finish of the baking trays and dishes used will affect base browning. Enamelware, dark, heavy or non-stick utensils increase base browning, while oven glassware, shiny aluminium or polished steel trays reflect the heat away and give less base browning.

Always place dishes centrally on the shelf to ensure even browning.

Stand dishes on suitably sized baking trays to prevent spillage onto the base of the oven and make cleaning easier.

Do not place dishes, tins or baking trays directly on the oven base as it becomes very hot and damage will occur.

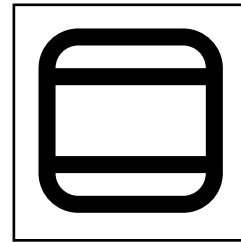

**CONVENTIONAL OVEN FUNCTION
SYMBOL
PRE-SET TEMPERATURE: 200°C
TEMPERATURE SELECTION: 50°C - 250°C**

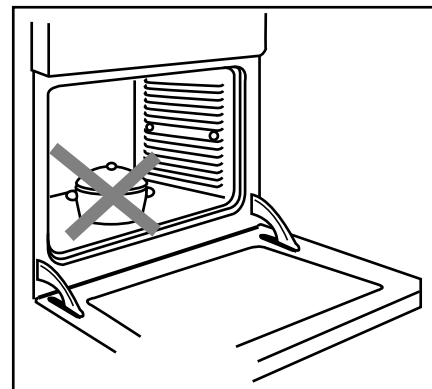
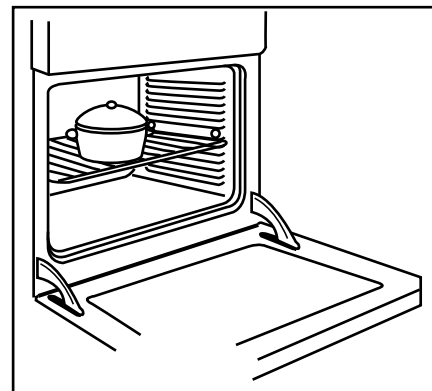



For faster preheating use the Fast Heat-Up Function.

Single level cooking gives best results. If you require more than one level cooking use the fan oven function.

Cooking Chart - Fan and Conventional Oven

The oven temperatures are intended as a guide only. It may be necessary to increase or decrease the temperatures by 10 °C to suit individual preferences and requirements.

NOTE: Shelf positions are counted from bottom of the oven.

Food	 Fan Oven		 Conventional Oven	
	Shelf Position	Cooking Temp (°C)	Shelf Position	Cooking Temp (°C)
Biscuits		180-190	3 - 4	180-190
Bread		210-220	3	210-220
Casseroles		130-140	3	150-180
Cakes: Small and queen	Shelf positions are not critical but ensure that oven shelves are evenly spaced when more than one is used.	160-170	3	170-180
Sponges		160-170	3	180-190
Madeira		140-150	3	160-170
Rich Fruit		130-140	3	150-160
Christmas		130-140	1 - 3	130-140
Meringues		90-100	3	100-110
Fish		170-190	3	170-190
Fruit Pies and Crumbles		190-200	3	190-200
Milk Puddings		130-140	3	130-140
Pastry: Choux	}	190-200	3 - 4	160-170
Shortcrust				
Flaky				
Puff				
Plate Tarts		180	1 - 3	190-200
Quiches/Flans		170-180	1 - 3	190-200
Scones		210-220	3	230
Roasting: Meat & Poultry		160-180	3	180-200

Defrosting

The oven fan operates without heat and circulates the air, at room temperature, inside the oven. This increases the speed of defrosting. However, please note that the temperature of the kitchen will influence the speed of defrosting.

This function is particularly suitable for defrosting delicate food which could be damaged by heat, e.g. cream filled gateaux, iced cakes, pastries, bread and other yeast products.

How to Use Defrosting

- 1) Switch the oven on by pressing button 1.
- 2) Press button 3 twice.

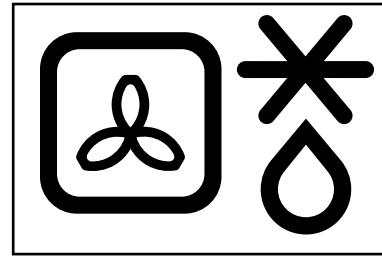

**DEFROSTING FUNCTION SYMBOL
PRE-SET TEMPERATURE: 32°C
TEMPERATURE SETTING CANNOT BE
CHANGED**

Hints and Tips

- Cover food with a lid, aluminium foil or plastic film to prevent drying out during defrosting.
- ALWAYS COOK THOROUGHLY IMMEDIATELY AFTER THAWING.
- Frozen food should be placed in a single layer when ever possible and turned over half way through the defrosting process.
- Only joints of meat and poultry up to 2 kg. (4 lb.) are suitable for defrosting in this way.

Refer to the following table for approximate defrosting times.

Food	Defrosting time (Mins)	Standing time (Mins)	Notes
Chicken 1000 g.	100-140	20-30	Place the chicken on an inverted saucer on a large plate. Defrost open and turn at half time or defrost covered with foil. Remove giblets as soon as possible.
Meat 1000 g.	100-140	20-30	Defrost open and turn at half time or cover with foil
Meat 500 g.	90-120	20-30	As above
Trout 150 g.	23-35	10-15	Defrost open
Strawberries 300 g.	30-40	10-20	Defrost open
Butter 250 g.	30-40	10-15	Defrost open
Cream 2 x 200 g.	80-100	10-15	Defrost open (cream is easy to whip even if parts of it are still slightly frozen)
Cake 1400 g.	60	60	Defrost open

The times quoted in the chart should be used as a guide only, as the speed of defrosting will depend on the kitchen temperature. For example, the colder the room temperature, the longer the defrosting time.

Grilling



Grilling must be carried out with the oven door closed. The grill pan handles must be removed from the pan.



How to Use the Grill

1. Switch the oven ON.
2. Press the Cooking Function Control Button until the pilot light to the left of  comes on.
3. If necessary, press the "Increase" or the "Decrease" buttons to adjust the temperature setting.
4. Adjust the grid and grill pan runner position to allow for different thicknesses of food. Position the food close to the element for faster cooking and further away for more gentle cooking.

Preheat the grill on a full setting for a few minutes before sealing steaks or toasting. Adjust the heat setting and the shelf as necessary, during cooking

During cooking, the cooling fan and the thermostat control light will operate in the same way as described for the fan oven function.



Hints and Tips

- Most foods should be placed on the grid in the grill pan to allow maximum circulation of air to lift the food out of the fats and juices. Food such as fish, liver and kidneys may be placed directly on the grill pan, if preferred.
- Food should be thoroughly dried before grilling to minimise splashing. Brush lean meats and fish lightly with a little oil or melted butter to keep them moist during cooking.
- Accompaniments such as tomatoes and mushrooms may be placed underneath the grid when grilling meats.
- When toasting bread, we suggest that the top runner position is used.
- The food should be turned over during cooking, as required.

The grill element is controlled by the thermostat. During cooking, the grill cycles on and off to prevent overheating.

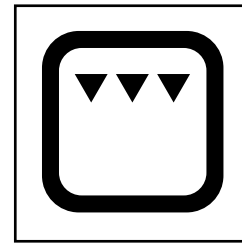

**GRILLING FUNCTION SYMBOL
PRE-SET TEMPERATURE: 250°C
TEMPERATURE SELECTION 50°C - 250°C**

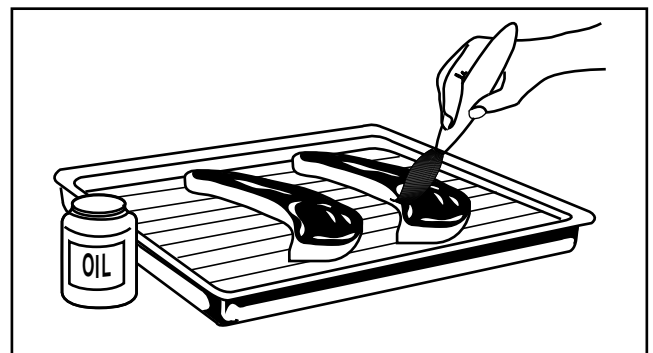

How to Use the Inner Grill Element

The inner grill provides quick direct heat to the central area of the grill pan. Use the inner grill element for cooking small quantities, it can help to save energy.

1. Switch the oven ON.
2. Press the Cooking Function Control Button until the pilot light to the left of  comes on
3. If necessary, press the "Increase" or the "Decrease" buttons to adjust the temperature setting.
4. Adjust the grid and grill pan runner position to allow for different thicknesses of food and follow the instructions for grilling.

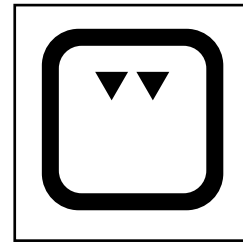

INNER GRILL ELEMENT SYMBOL
PRE-SET TEMPERATURE: 250°C
TEMPERATURE SELECTION 50°C - 250°C

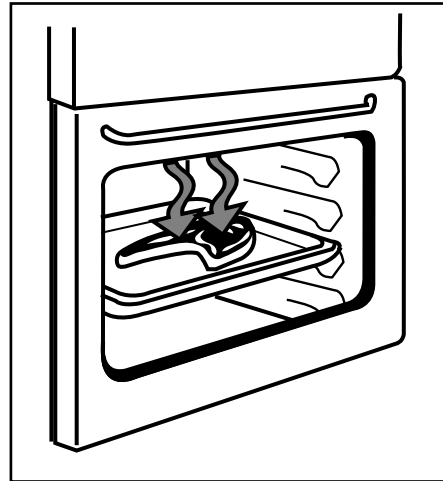

How to Use the Thermal Grill

Thermal grilling offers an alternative method of cooking food items normally associated with conventional grilling. The grill element and the oven fan operate alternately, circulating hot air around the food. The need to check and turn the food is reduced. Thermal grilling helps to minimize cooking smells in the kitchen.

With the exception of toast and rare steaks, you can thermally grill all the foods you would normally cook under a conventional grill. Cooking is more gentle, therefore food generally takes a little longer to cook with thermal grilling compared with conventional grilling. One of the advantages is that larger quantities can be cooked at the same time.

1. Switch the oven ON.
2. Press the Cooking Function Control Button until the pilot light to the left of  comes on.
3. If necessary, press the "Increase" or the "Decrease" buttons to adjust the temperature setting.
4. Adjust the grid and grill pan runner position to allow for different thicknesses of food and follow the instructions for grilling.

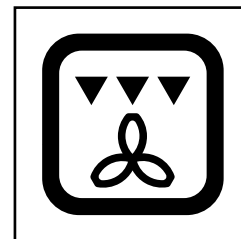

THERMAL GRILLING
PRE-SET TEMPERATURE: 180°C
TEMPERATURE SELECTION 50°C - 250°C
DO NOT EXCEED 200°C

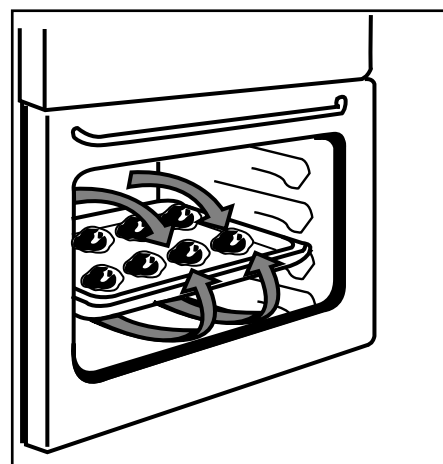



Hints and Tips

Prepare foods in the same way as for conventional grilling. Brush lean meats and fish lightly with little oil or butter to keep them moist during cooking.

If thermally grilling on more than one level, it may be necessary to interchange the food on the shelves during cooking.

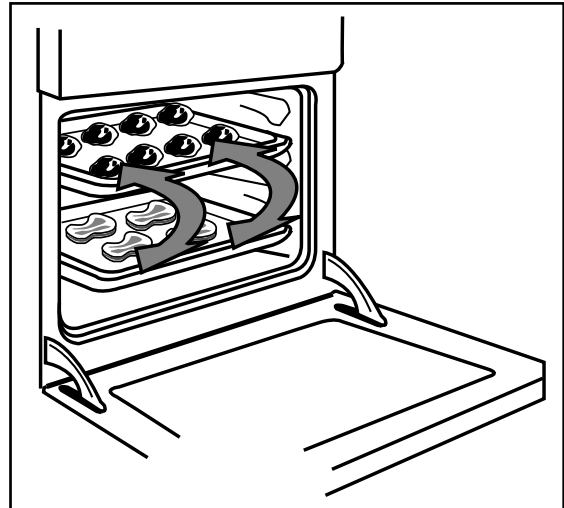
A general guide to cooking times is given below but these times may vary slightly depending on the thickness and quantity of food being cooked.



Quantity Gr.	Pieces	TYPE OF FOOD	  GRILL - INNER GRILL				
			pre-heat minutes	shelf level	Temp. °C	cooking time (in mins) *	
						1st side	2nd side
800	4	Beef fillets	-	5	250	8-10	4-6
600	4	Pork chops	-	5	250	8-10	5-8
800	8	Spare ribs	-	5	250	6-8	4-6
500	8	Sausages	-	5	250	8-10	4-6
700	4	Kebabs	-	5	250	10-12	5-7
500	4	Chicken breasts	-	5	250	10-12	5-7
500	6	Sole	-	5	250	6-8	4-6
	6	Toast bread	-	5	250	3-4	1-2

Quantity Gr.	Pieces	TYPE OF FOOD	 THERMAL GRILLING Select a maximum temperature of 200°C				
			pre-heat minutes	shelf level	Temp. °C	cooking time in (mins) *	
						1st side	2nd side
1000	2	Rolled joints { Beef Lamb Pork	-	4	180	30-40	20-30
800	4	Quartered chicken	-	4	200	25-30	15-20
1000	2	Chickens	-	4	190	30-35	25-30
800	1	Guinea fowl	-	3	180	35-40	30-35
500	2	Pigeons	-	4	180	35-40	30-35
500	4	Quail	-	4	200	25-30	20-25
		Vegetable gratin	-	4	200	15-25	-
	4	Toasted sandwiches	-	4	200	3-5	1-2
	9	St. Jacques shells	-	4	200	15-20	-
600	2	Mackerel	-	4	200	10-20	6-8
800	4	Fish slices	-	4	200	10-15	8-10

(*) Food should be turned during cooking using these times as a guide
The times quoted above are given as a guide and should be adjusted to suit personal taste.



Pizza Oven

The bottom element provides direct heat to the base of pizzas, quiches or pies, while the fan ensures air is circulated to cook the pizza toppings or pie fillings. To obtain the best results use the lower shelf levels.

1. Switch the oven ON.
2. Press the Cooking Function Control Button until the pilot light to the left of  comes on.
3. If necessary, press the "Increase" or the "Decrease" buttons to adjust the temperature setting.



PIZZA OVEN FUNCTION SYMBOL
PRE-SET TEMPERATURE: 175°C
TEMPERATURE SELECTION: 50°C - 250°C

TYPE OF FOOD	 PIZZA OVEN		Cooking time  minutes
	Shelf	Temp °C	
Pizza, large	1	210-230	15-20
Pizza, small	1	200-220	10-20
Quiche	1	160-180	30-40
Sweet Tart (treacle)	1	170-180	20-30
Fruit Tart	1	170-180	25-30
Blind Baked Flan Cases	1	170-180	15-20
Egg Custard Tart	1	160-170	40-50



Baking Function

When using this function, the top and bottom elements will heat the oven cavity and the fan will circulate hot air around your dishes. This offers an alternative cooking method particularly suitable for baking.

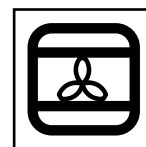
1. Switch the oven ON.
2. Press the Cooking Function Control Button until the pilot lamp to the left of symbol  comes on.



BAKING FUNCTION SYMBOL
PRE-SET TEMPERATURE: 175°C
TEMPERATURE SELECTION: 50°C - 250°C

TYPE OF FOOD	 BAKING FUNCTION		Cooking time  minutes
	Shelf	Temp °C	
Cookies		160-170	10-15
Boiled Fruit Cake		140-150	25-30
Queen Cake		150-160	20-25
Viennese Tarts		150-160	15-20
Wholemeal Bread		180-200	25-35
Bread Rolls		190-210	15-20
Teacakes		180-190	15-20
	Shelf positions are not critical but ensure that oven shelves are evenly spaced when more than one is used.		

Cleaning the Oven



Before cleaning always allow the cooling fan to cool the oven down before switching off at the electricity supply.

The oven should be kept clean at all times. A build-up of fats or other foodstuffs could result in a fire, especially in the grill pan.

Cleaning materials

Before using any cleaning materials on your oven, check that they are suitable and that their use is recommended by the manufacturer.

Cleaners that contain bleach should NOT be used as they may dull the surface finishes. Harsh abrasives should also be avoided.

External cleaning

Regularly wipe over the control panel, oven door and door seal using a soft cloth well wrung out in warm water to which a little liquid detergent has been added.



To prevent damaging or weakening the door glass panels avoid the use of the following:

- Household detergent and bleaches
- Impregnated pads unsuitable for non-stick saucepans
- Brillo/Ajax pads or steel wool pads
- Chemical oven pads or aerosols
- Rust removers
- Bath/Sink stain removers

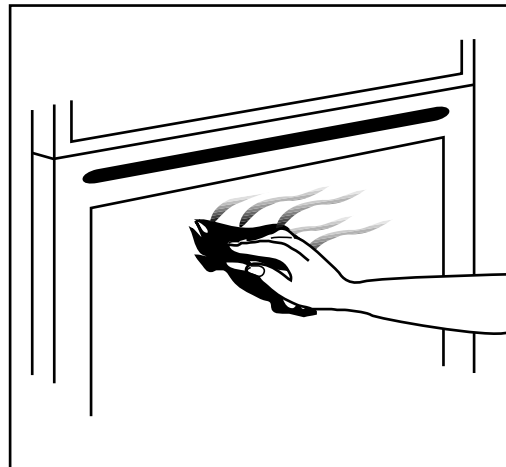

Clean the outer and inner door glass using warm soapy water. Should the inner door glass become heavily soiled it is recommended that a cleaning product such as Hob Brite is used. Do not use paint scrapers to remove soilage.



DO NOT clean the oven door while the glass panels are warm. If this precaution is not observed the glass panel may shatter.

If the door glass panel becomes chipped or has deep scratches, the glass will be weakened and must be replaced to prevent the possibility of the panel shattering. Contact your local Service Force Centre who will be pleased to advise further.

Oven Cavity

The enamelled oven cavity is best cleaned whilst the oven is still warm.

Wipe the oven over with a soft cloth soaked in warm soapy water after each use. From time to time it will be necessary to do a more thorough cleaning, using a proprietary oven cleaner.

If the soilage has become set, after the oven has cooled down, the following process will help to soften the splatters to help make cleaning easier.

1. Place the grill/ meat pan on the oven shelf positioned in the lowest runner.
2. Add a few drops of washing-up liquid to the pan and fill to about 12 mm. with boiling water from the kettle.
3. Close the oven door, select the Fan Oven function  and set the temperature on 50°C.
4. After 15 minutes, set the temperature on zero and allow the fan oven to continue without heat for a further 5 minutes, when the temperature of the water will have cooled down.
5. Carefully remove the pan of water from the oven and use normal oven cleaners to clean away soil residues.
6. Leave a little of the soapy water to soak into any burned on spillage on the floor of the oven for a longer time if necessary.

Oven Shelves and Shelf Supports

To clean the oven shelves and the shelf supports, soak in warm soapy water and remove stubborn marks with a well wetted soap impregnated pad. Rinse well and dry with a soft cloth.

The shelf supports can be removed for easy cleaning (see diagram). Please, ensure the retaining nuts are secure when refitting the shelf support.

Grease Filter

To prevent a build-up of fats on the fan impellor, the grease filter must be fitted by clipping it over the vents in the back panel.

To clean the grease filter

When the oven has cooled down, remove the filter by pushing the protruding tongue on the filter upward, and wash carefully.

The grease filter should be cleaned after every use. The filter may be washed in a dishwasher on a 65°C wash. If the filter is heavily soiled, place the filter in a saucepan of water with approximately 1 teaspoon of automatic washing powder or dishwasher powder. Bring to the boil and leave to soak for approximately 30 minutes or longer depending on the degree of soiling. Ensure the solution does not boil over as it could mark your hob.

Rinse filter in clear water and dry.

Remember to refit the filter before using the oven again.

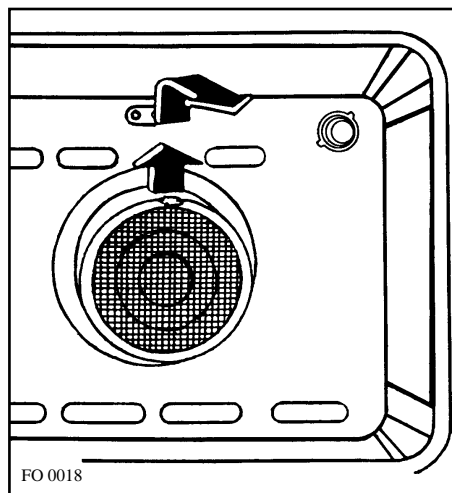
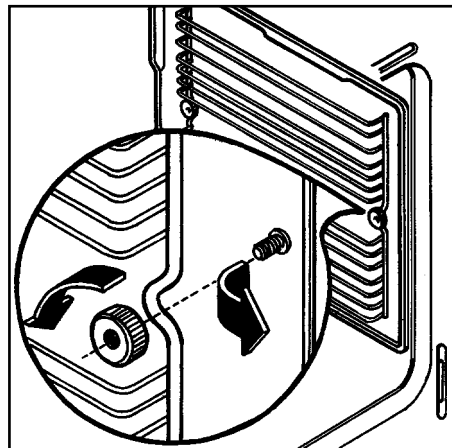

Replacing the Oven Light

If the oven bulb needs replacing, it must comply with the following specifications:

- Electric power: 15W,
- Electric rate: 230-240 V (50 Hz),
- Resistant to temperatures of 300°C,
- Connection type: E14.

These bulbs are available from your local Zanussi Force Service Centre.



To replace the faulty bulb:

1. Ensure the oven is isolated from the electrical supply.
2. Turn the glass cover anticlockwise.
3. Remove the faulty bulb and replace with the new one.
4. Refit the glass cover.
5. Restore the electrical supply.

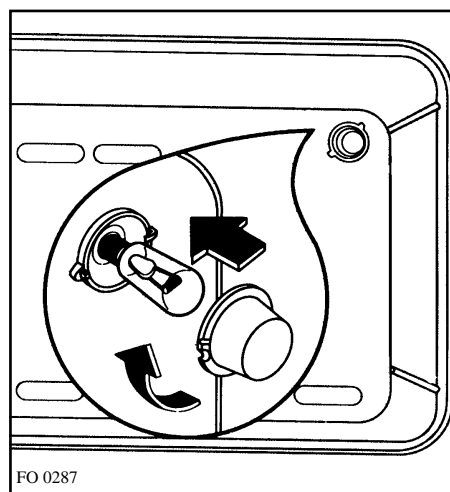

Cleaning the hinged grill

This model has been fitted with a hinged grill element to enable you to clean the roof of the oven easily.



Before proceeding ensure the oven is cool and is isolated from the electricity supply.



- 1) Undo the screw which holds the grill in place (see diagram).

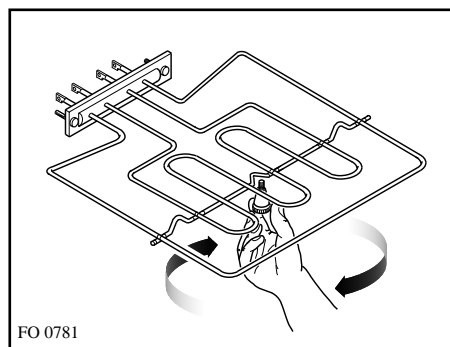

- 2) Then gently pull the grill downward to allow access to the oven roof (see diagram).

- 3) Clean the oven roof with a suitable cleaner and wipe dry before replacing the hinged grill element.

- 4) Gently push up the grill element into place and firmly screw into place the holding nut.

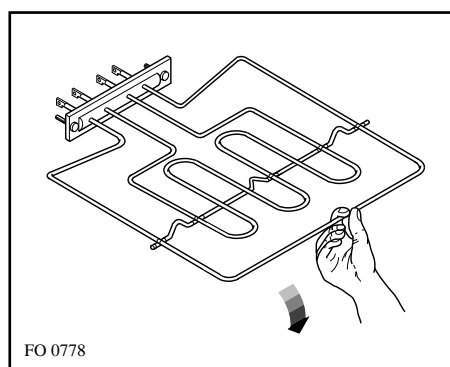

Ensure the grill holding nut is firmly in place to avoid the grill falling down when in use

If something goes wrong

If the oven is not working correctly, please carry out the following checks, before contacting your local Zanussi Service Force Centre.

IMPORTANT: If you call out an engineer to a fault listed below, or to repair a fault caused by incorrect use or installation, a charge will be made even if the appliance is under guarantee.

SYMPTOM	SOLUTION
■ The oven does not come on	<ul style="list-style-type: none">◆ Press the OVEN ON button, then select a cooking function.◆ Check the fuse and ensure the socket switch or the switch from the mains supply to the oven are ON.
■ The oven light does not come on	<ul style="list-style-type: none">◆ Switch on the oven using push button 1.◆ Check the light bulb, and replace it if necessary (see "Replacing the Oven Light")
■ It takes too long to finish the dishes, or they are cooked too fast.	<ul style="list-style-type: none">◆ The temperature may need adjusting◆ Refer to the cooking function sections and to any cooking chart provided
■ Steam and condensation settle on the food and the oven cavity.	<ul style="list-style-type: none">◆ Leave dishes inside the oven no longer than 15-20 minutes after the cooking is completed.
■ The timer does not work	<ul style="list-style-type: none">◆ Check the instructions for the timer.
■ The oven fan is noisy	<ul style="list-style-type: none">◆ Check the grease filter is correctly fitted.◆ Check that shelves and bakeware are not vibrating in contact with the oven back panel.

If after all these checks, the oven still does not work, contact your local Zanussi Service Force Centre.

When you contact them, they will need the following information:

1. Your name, address and post code.
2. Your telephone number
3. Clear and concise details of the fault
4. The model and the serial number (which can be found on the rating plate)
5. Date of purchase

Please note that it will be necessary to provide proof of purchase for any in-guarantee service calls.

In-guarantee customers should ensure that the above checks have been made as the engineer will make a charge if the fault is not a mechanical or electrical breakdown.

Service and Spare Parts



If you require spare parts or an engineer contact your local Service Force Centre by telephoning:

0870 5 929929

Your call will be routed to your local Service Force Centre. For further details, please see the accompanying Customer Care Booklet.

CUSTOMER CARE

For general enquiries concerning your Zanussi appliance, contact our Customer Care Department by letter or telephone as follows:

Customer Care Department ZANUSSI

Zanussi House
Hambridge Road
Newbury, Berks, RG14 5EP
Tel: 01635 - 521313

Peace of Mind for 24 Months

ZANUSSI GUARANTEE CONDITIONS

We, Zanussi, undertake that if, within 24 months of the date of the purchase, this Zanussi appliance or any part thereof is proved to be defective by any reason only of faulty workmanship or materials, we will, at our option, repair or replace the same **FREE OF ANY CHARGE** for labour, materials or carriage on condition that:

- * The appliance has been correctly installed and used only on the gas and electricity supply stated on the rating plate.
- * The appliance has been used for normal domestic purpose only, and in accordance with the manufacturer's instructions.
- * The appliance has not been serviced, maintained, repaired, taken apart or tampered with by any person not authorised by us.
- * All service work under this guarantee must be undertaken by a Zanussi Service Centre.
- * Any appliance or defective part replaced shall become the Company's property.
- * This guarantee is in addition to your statutory and other legal rights.

Home visits are made between **8.30am and 5.30pm** Monday to Friday. Visits may be available outside these hours, in which case a **premium** will be charged.

Exclusions

This guarantee does not cover:

- * Damage or calls resulting from transportation, improper use or neglect, the replacement of any light bulbs or removable parts of glass or plastic.
- * Costs incurred for calls to put right an appliance which is improperly installed or calls to appliance outside the United Kingdom.
- * Appliances found to be in use within a commercial or similar environment, plus those which are the subject to rental agreements.

- * Products of Zanussi manufacture which are not marketed by Zanussi.

European Guarantee

If you should move to another country within Europe then your guarantee moves with you to your new home subject to the following qualifications:

- * The guarantee starts from the date you first purchased your product.
- * The guarantee is for the same period and to the same extent for labour and parts as exist in the new country of use for this brand or range of products.
- * This guarantee relates to you and cannot be transferred to another user.
- * Your new home is within the European Community (EC) or European Free Trade Area.
- * The product is installed and used in accordance with our instructions and is only used domestically, i.e. a normal household
- * The product is installed taking into account regulations in your new country.

Before you move, please contact your nearest Customer Care centre, listed below, to give them details of your new home. They will then ensure that the local Service Organisation is aware of your move and able to look after you and your appliances.

France	Senlis	+33 (0)3 44 62 29 99
Germany	Nürnberg	+49 (0)911 323 2600
Italy	Pordenone	+39 (0)1678 47053
Sweden	Stockholm	+46 (0)8 738 79 50
UK	Newbury	+44 (0)1635 521 313

Installation



The oven must be installed according to the instructions supplied.



This oven must be installed by **qualified personnel** to the relevant British Standards.

Technical Data

DIMENSIONS OF RECESS		
Height		580 mm.
Width		560-570 mm.
Depth		550 mm.

DIMENSIONS OF THE OVEN CAVITY		
Height		320 mm.
Width		420 mm.
Depth		390 mm.
Oven capacity		53.2 litres

Heating elements rating

Oven element	1.89 kW
Top element	0.834 kW
Bottom element	1.055 kW
Convection element	2.08 kW
Grill element	1.82 kW
Double Grill element	2.655 kW
Pizza Oven Function	3.135 kW
Convection Fan	30 W
Oven Light	15 W
Cooling Fan	25 W
Total Rating	3.200 kW

Electrical Connection

The oven is designed to be connected to 230-240V (50Hz) electricity supply.

The oven has an easily accessible terminal block which is marked as follows:

- Letter L - Live terminal
- Letter N - Neutral terminal
-  - Earth terminal

THIS OVEN MUST BE EARTHED

This oven is provided with a type H05RR-F connection cable with section 3x1,5 mm².

It is necessary that you install a double pole switch between the oven and the electricity supply (mains), with a minimum gap of 3mm between the switch contacts and of a type suitable for the required load in compliance with the current rules.

The switch must not break the yellow and green earth cable at any point.

Important

After installation and connecting, the cable must be placed so that it cannot at any point reach a temperature of more than 60°C above the ambient temperature.

Before the oven is connected, check that the main fuse and the domestic installation can support the load; and that the power supply is properly earthed.

The manufacturer disclaims any responsibility should these safety measures not be carried out.

Building In

Please ensure that when the oven is installed it is easily accessible for the engineer in the event of a breakdown.

The surround or cabinet into which the oven will be built must comply with these specifications:

- the dimensions must be as shown in the relevant diagrams;
- the materials must withstand a temperature increase of at least 60°C above ambient;
- proper arrangements must be made of a continuous supply of air to the oven to prevent the oven overheating.

Dimensions of the oven and recess required are given in the relevant diagrams.

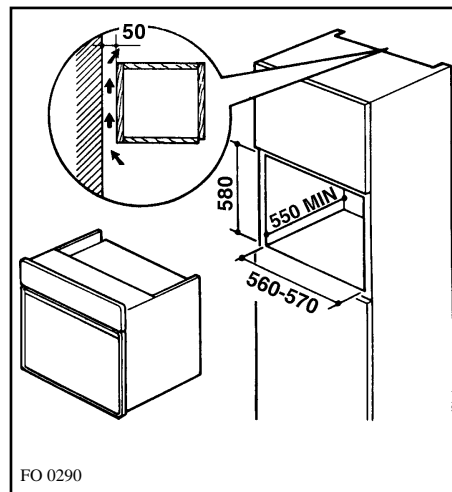
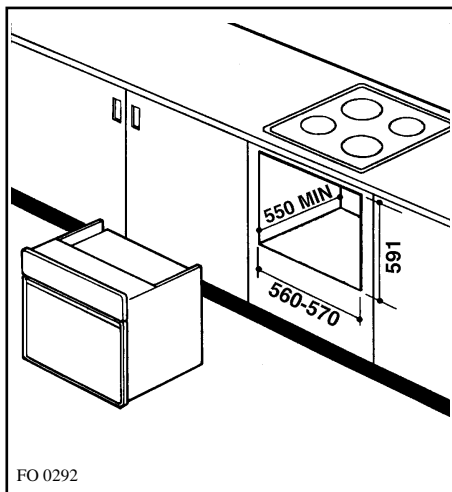
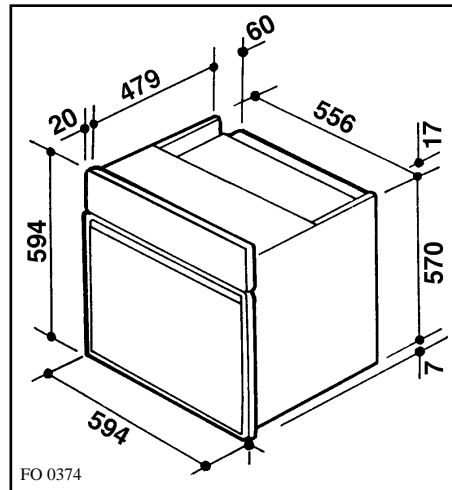

Securing The Oven To The Cabinet

1. Fit the oven into the cabinet recess,
2. Open the oven door
3. Secure the oven to the kitchen cabinet with four wood screws, which fit the holes provided in the oven frame.

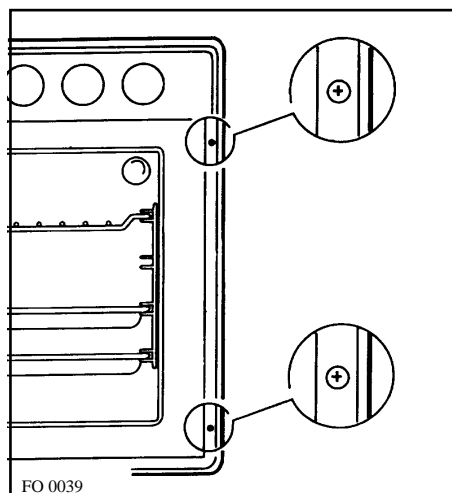

Free Manuals Download Website

<http://myh66.com>

<http://usermanuals.us>

<http://www.somanuals.com>

<http://www.4manuals.cc>

<http://www.manual-lib.com>

<http://www.404manual.com>

<http://www.luxmanual.com>

<http://aubethermostatmanual.com>

Golf course search by state

<http://golfingnear.com>

Email search by domain

<http://emailbydomain.com>

Auto manuals search

<http://auto.somanuals.com>

TV manuals search

<http://tv.somanuals.com>