

EN

User manual

Oven

# USER MANUAL

ZOD35561

**ZANUSSI**

# Contents

---

Safety information _____	2	Care and cleaning _____	14
Safety instructions _____	3	What to do if... _____	16
Product description _____	5	Installation _____	17
Before first use _____	5	Environment concerns _____	19
Daily use _____	6	GREAT BRITAIN & IRELAND - Guarantee/	
Clock functions _____	7	Customer Service _____	19
Using the accessories _____	8	European Guarantee _____	20
Helpful hints and tips _____	9		

Subject to change without notice.

## Safety information

---

Before the installation and use of the appliance, carefully read the supplied instructions. The manufacturer is not responsible if an incorrect installation and use causes injuries and damages. Always keep the instructions with the appliance for future reference.

### Children and vulnerable people safety

**⚠ Warning!** Risk of suffocation, injury or permanent disability.

- This appliance can be used by children aged from 8 years and above and persons with reduced physical, sensory or mental capabilities or lack of experience and knowledge if they are supervised by an adult or a person who is responsible for their safety.
- Do not let children play with the appliance.
- Keep all packaging away from children.
- Keep children and pets away from the appliance when it operates or when it cools down. Accessible parts are hot.
- If the appliance has a child safety device, we recommend that you activate it.
- Cleaning and user maintenance shall not be made by children without supervision.

### General Safety

- Internally the appliance becomes hot when in operation. Do not touch the heating elements that are in the appliance. Always use oven gloves to remove or put in accessories or ovenware.

- Do not use a steam cleaner to clean the appliance.
- Before maintenance cut the power supply.
- Do not use harsh abrasive cleaners or sharp metal scrapers to clean the glass door since they can scratch the surface, which may result in shattering of the glass.
- To remove the shelf supports first pull the front of the shelf support and then the rear end away from the side walls. Install the shelf supports in the opposite sequence.

## Safety instructions

### Installation

 **Warning!** Only a qualified person must install this appliance.

- Remove all the packaging.
- Do not install or use a damaged appliance.
- Obey the installation instruction supplied with the appliance.
- Always be careful when you move the appliance because it is heavy. Always wear safety gloves.
- Do not pull the appliance by the handle.
- Keep the minimum distance from the other appliances and units.
- Make sure that the appliance is installed below and adjacent safe structures.
- The sides of the appliance must stay adjacent to appliances or to units with the same height.

### Electrical connection

 **Warning!** Risk of fire and electrical shock.

- All electrical connections should be made by a qualified electrician.
- The appliance must be earthed.
- Make sure that the electrical information on the rating plate agrees with the power supply. If not, contact an electrician.
- Always use a correctly installed shockproof socket.

- Do not use multi-plug adapters and extension cables.
- Make sure not to cause damage to the mains plug and to the mains cable. Contact the Service or an electrician to change a damaged mains cable.
- Do not let mains cables to come in touch with the appliance door, specially when the door is hot.
- The shock protection of live and insulated parts must be fastened in such a way that it cannot be removed without tools.
- Connect the mains plug to the mains socket only at the end of the installation. Make sure that there is access to the mains plug after the installation.
- If the mains socket is loose, do not connect the mains plug.
- Do not pull the mains cable to disconnect the appliance. Always pull the mains plug.
- Use only correct isolation devices: line protecting cut-outs, fuses (screw type fuses removed from the holder), earth leakage trips and contactors.
- The electrical installation must have an isolation device which lets you disconnect the appliance from the mains at all poles. The isolation device must have a contact opening width of minimum 3 mm.

### Use

 **Warning!** Risk of injury, burns or electric shock or explosion.

- Use this appliance in a household environment.
- Do not change the specification of this appliance.
- Make sure that the ventilation openings are not blocked.
- Do not let the appliance stay unattended during operation.
- Deactivate the appliance after each use.
- Be careful, when you open the appliance door while the appliance is in operation. Hot air can release.
- Do not operate the appliance with wet hands or when it has contact with water.
- Do not apply pressure on the open door.
- Do not use the appliance as a work surface or as a storage surface.
- Always keep the appliance door closed when the appliance is in operation.
- Open the appliance door carefully. The use of ingredients with alcohol can cause a mixture of alcohol and air.
- Do not let sparks or open flames to come in contact with the appliance when you open the door.
- Do not put flammable products or items that are wet with flammable products in, near or on the appliance.

 **Warning!** Risk of damage to the appliance.

- To prevent damage or discoloration to the enamel:
  - Do not put ovenware or other objects in the appliance directly on the bottom.
  - Do not put aluminium foil directly on the bottom of the appliance.
  - do not put water directly into the hot appliance.
  - do not keep moist dishes and food in the appliance after you finish the cooking.
  - be careful when you remove or install the accessories.

- Discoloration of the enamel has no effect on the performance of the appliance. It is not a defect in the sense of the warranty law.
- Use a deep pan for moist cakes. Fruit juices cause stains that can be permanent.

## Care and Cleaning

 **Warning!** Risk of injury, fire or damage to the appliance.

- Before maintenance, deactivate the appliance and disconnect the mains plug from the mains socket.
- Make sure the appliance is cold. There is the risk that the glass panels can break.
- Replace immediately the door glass panels when they are damaged. Contact the Service.
- Be careful when you remove the door from the appliance. The door is heavy!
- Clean regularly the appliance to prevent the deterioration of the surface material.
- Remaining fat or food in the appliance can cause fire.
- Clean the appliance with a moist soft cloth. Only use neutral detergents. Do not use abrasive products, abrasive cleaning pads, solvents or metal objects.
- If you use an oven spray, obey the safety instructions on the packaging.
- Do not clean the catalytic enamel (if applicable) with any kind of detergent.

## Internal light

- The type of light bulb or halogen lamp used for this appliance, is only for household appliances. Do not use it for house lighting.

 **Warning!** Risk of electrical shock.

- Before replacing the lamp, disconnect the appliance from the power supply.
- Only use lamps with the same specifications.

## Service

- Contact the Service to repair the appliance. We recommend only the use of original spare parts.

## Disposal

**Warning!** Risk of injury or suffocation.

- Disconnect the appliance from the mains supply.

- Cut off the mains cable and discard it.
- Remove the door catch to prevent children and pets to get closed in the appliance.

## Product description

### General overview

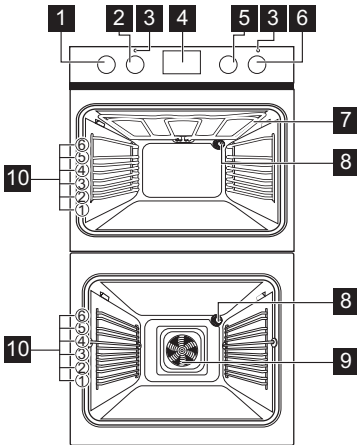

- 1 Knob for the top oven functions
- 2 Knob for the top oven temperature
- 3 Temperature indicator
- 4 Electronic programmer
- 5 Knob for the main oven functions
- 6 Knob for the main oven temperature
- 7 Heating element
- 8 Oven lamp
- 9 Fan and heating element
- 10 Shelf positions

### Accessories

- **Oven shelf**  
For cookware, cake tins, roasts.
- **Roasting pan grid**

To put in the deep roasting pan.

- **Deep roasting pan**  
To bake and roast or as a pan to collect fat.

## Before first use

**Warning!** Refer to the Safety chapters.

### Initial Cleaning

- Remove all accessories and removable shelf supports (if applicable).
- Clean the appliance before first use.

**Important!** Refer to the chapter "Care and cleaning".



### Setting the time

- i** You must set the time before you operate the oven.

When you connect the appliance to the electrical supply or after a power cut, the indicator for the Time of Day function flashes. Press the **+** or **-** button to set the correct time.



After approximately five seconds, the flashing stops and the display shows the time of day you set.

 To change the time, press  again and again until the indicator for the Time of Day function flashes. You must not set the Duration  $\rightarrow$  or End  $\rightarrow$  function at the same time.

### Preheating

Preheat the empty appliance to burn off the remaining grease.

Preheat the two ovens. Heat up one oven at a time.

Set the functions listed below, if applicable.

## Daily use



 **Warning!** Refer to the Safety chapters.

### Cooling fan

When the appliance operates, the cooling fan switches on automatically. If you switch off the appliance, the cooling fan continues to operate until the appliance cools down.

### Activating and deactivating the top oven

1. Turn the knob for the top oven functions to an oven function.
2. Turn the knob for the top oven temperature to a temperature.  
The temperature indicator comes on while the temperature in the appliance increases.
3. To deactivate the appliance, turn the knob for the top oven functions and the knob for





1. Set the function  and the maximum temperature.
2. Let the appliance operate for one hour.
3. Set the function  and the maximum temperature.
4. Let the appliance operate for ten minutes.
5. Set the function  and the maximum temperature.
6. Let the appliance operate for ten minutes.  
Accessories can become hotter than usually. The appliance can emit an odour and smoke. This is normal. Make sure that the airflow is sufficient.



the top oven temperature to the Off position.

### Activating and deactivating the main oven





1. Turn the knob for the main oven functions to an oven function.
2. Turn the knob for the main oven temperature to a temperature.  
The temperature indicator comes on while the temperature in the appliance increases.
3. To deactivate the appliance, turn the knob for the main oven functions and the knob for the main oven temperature to the Off position.

### Top oven functions

Oven function		Application
	OFF position	The appliance is OFF.
	Bottom Heat	To bake cakes with crispy or crusty bases and to preserve food.
	Single Circuit Grill	To grill flat food items in small quantities in the middle of the grill. To make toast.
	Light	To light up the oven interior.

Oven function	Application
 Top Heat	To brown bread, cakes and pastries and for bakes.
 Conventional Cooking	To bake and roast on one level
 Dual Circuit Grill	To grill flat food items in large quantities. To make toast.



## Main oven functions

Oven function	Application
 OFF position	The appliance is OFF.
 Light	To light up the oven interior.
 Thermaflow®	Roast or roast and bake food at the same cooking temperature on different levels at the same time.
 Defrost	To defrost frozen food.

## Clock functions

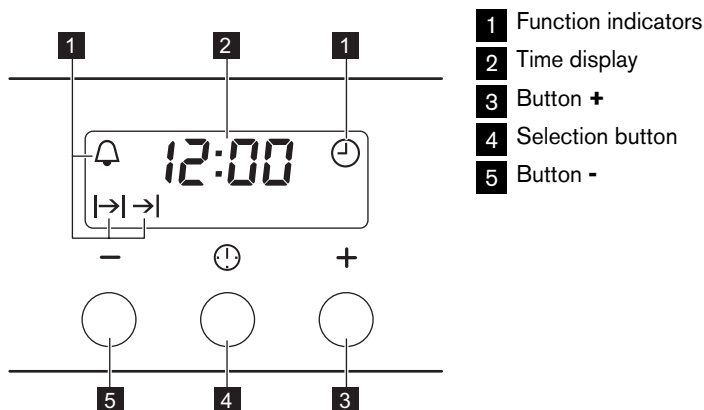
### Electronic programmer



Clock function	Application
 Time of day	To set, change or check the time of day.
 Minute Minder	To set a countdown time. This function has no effect on the operation of the oven.

Clock function		Application
→	Duration	To set how long the appliance must operate.
→	End	To set when the appliance must be deactivated.

**i** You can use Duration |→| and End →| at the same time to set the time when the appliance must be activated and then deactivated. First set Duration, then End.

### Setting the clock functions

1. For Duration |→| and End →|, set an oven function and temperature. This is not necessary for the Minute Minder .
2. Press the Selection button again and again until the indicator for the necessary clock function flashes.



3. Press **+** or **-** to set the necessary clock function. The display shows the indicator for the clock function you set. When the set time ends, the indicator flashes and an acoustic signal sounds for two minutes.

**i** With the Duration |→| and End →| functions, the appliance deactivates automatically.

4. Press a button to stop the signal.
5. Turn the knob for the oven functions and the knob for the temperature to the off position.

### Cancelling the clock functions

1. Press the Selection button again and again until the necessary function indicator flashes.
2. Press and hold the button **-**. The clock function goes out after some seconds.

## Using the accessories

**!** **Warning!** Refer to the Safety chapters.

### Inserting the oven accessories

Put in the slide-in accessories so that the double side edges are at the back of the oven and point down to the bottom. Push the slide-in accessories between the guide-bars of one of the oven levels.

**i** The deep roasting pan and the oven shelf have double side edges. These edges and the shape of the guide-bars causes the anti-tilt safety for the oven accessories.

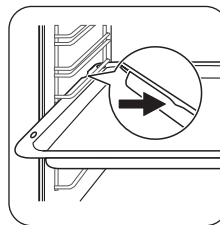



## Inserting the oven shelf and deep roasting pan together

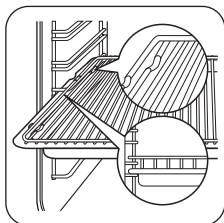

Put the oven shelf on the deep roasting pan. Push the deep roasting pan between the guide-bars of one of the oven levels.

### Grilling set

The grilling set includes the roasting pan grid and the deep roasting pan. You can use the roasting pan grid on the two sides.

**Warning!** Risk of burns when removing the accessories from a hot oven.

You can use the grilling set to roast larger pieces of meat or poultry on one level:

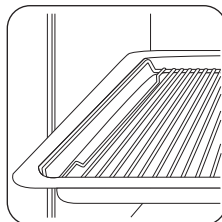

Put the roasting pan grid inside the deep roasting pan so that the supports of the oven shelf point upwards.

You can use the grilling set to grill flat dishes in large quantities and to toast:

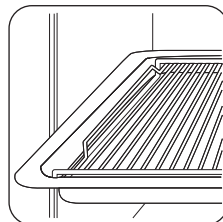

Put the roasting pan grid inside the deep roasting pan so that the supports of the oven shelf point downwards.

Put the deep roasting pan in the oven at the necessary level.

## Helpful hints and tips

**Warning!** Refer to the Safety chapters.

**i** The temperature and baking times in the tables are guidelines only. They depend on the recipes, quality and quantity of the ingredients used.

**Caution!** Use a deep baking tray for very moist cakes. Fruit juices can cause permanent stains on the enamel.

### Top oven

The top oven is the smaller of the two ovens. It has 6 shelf levels. Use is to cook smaller quantities of food. It gives especially good results when used to cook fruitcakes, sweets and savoury flants or quiche.

### Main oven

The main oven is particularly suitable for cooking larger quantities of food.

## Baking

### General instructions

- Your new oven may bake or roast differently to the appliance you had before. Adapt your usual settings (temperature, cooking times) and shelf levels to the values in the tables.
- With longer baking times, the oven can be switched off about 10 minutes before the end of baking time, to use the residual heat.

**When you use frozen food, the trays in the oven can twist during baking. When the trays get cold again, the distortion will be gone.**

### How to use the Baking Tables

- We recommend to use the lower temperature the first time.
- If you cannot find the settings for a special recipe, look for the one that is almost the same.
- Baking time can be extended by 10-15 minutes, if you bake cakes on more than one level.

- Cakes and pastries at different heights do not always brown equally at first. If this occurs, do not change the temperature setting.

The differences equalize during the baking procedure.

## Tips on baking

Baking results	Possible cause	Remedy
The cake is not browned sufficiently below	Incorrect oven level	Put the cake on a lower oven level
The cake sinks (becomes soggy, lumpy, streaky)	Oven temperature too high	Use a lower setting
The cake sinks (becomes soggy, lumpy, streaky)	Baking time is too short	Set a longer baking time <b>Do not set higher temperatures to decrease baking times</b>
The cake sinks (becomes soggy, lumpy, streaky)	Too much liquid in the mixture	Use less liquid. Look at the mixing times, especially when you use mixing machines
Cake is too dry	Oven temperature too low	Set a higher oven temperature
Cake is too dry	Baking time too long	Set a shorter baking time
Cake does not brown equally	Oven temperature too high and baking time too short	Set a lower oven temperature and a longer baking time
Cake does not brown equally	No equal mixture	Put the mixture equally on the baking tray
Cake does not cook in the baking time set	Temperature too low	Use a slightly higher oven temperature setting

## Top oven

### Baking

-  Shelf Positions are not critical but ensure that oven shelves are evenly spaced when

more than one is used (e.g. shelf positions 1 and 3)

Food	Temperature [°C]	Approx Cook Time (mins)	Shelf Position
Biscuits	170 - 190	10 - 20	1
Bread	200 - 220	30 - 35	1
Bread rolls/buns	200 - 220	10 - 15	1
Cakes:			
- Small & Queen	170 - 180	18 - 25	1
- Sponges	160 - 175	20 - 30	1
- Victoria Sandwich	160 - 170	18 - 25	1
- Madeira	140 - 150	75 - 90	1
- Rich Fruit	140 - 150	120 - 150	1
- Gingerbread	140 - 150	75 - 90	1
- Meringues	90 - 100	150 - 180	1

Food	Temperature [°C]	Approx Cook Time (mins)	Shelf Position
- Flapjack	160 - 170	25 - 30	1
- Shortbread	130 - 150	45 - 65	1
Casseroles:			
- Beef/Lamb	150 - 170	150 - 180	1
- Chicken	160 - 180	75 - 90	1
Convenience Foods	Follow manufacturer's instructions.		
Fish	170 - 190	20 - 30	1
Fish Pie (Potato Topped)	190 - 200	20 - 30	1
Fruit Pies, Crumbles	190 - 200	30 - 50	1
Milk Puddings	150 - 170	90 - 120	1
Pasta Lasagne etc.	170 - 180	40 - 50	1
Pastry:			
- Choux	180 - 190	30 - 40	1
- Eclairs, Profiteroles	180 - 190	30 - 40	1
- Flaky/Puff Pies	210 - 220	30 - 40	1
Shortcrust:			
- Mince Pies	190 - 200	15 - 20	1
- Meat Pies	190 - 210	25 - 35	1
- Quiche, Tarts, Flans	180 - 200	25 - 50	1
Scones	220 - 230	8 - 12	1
Shepard's Pie	190 - 200	30 - 40	1
Soufflés	180 - 190	20 - 30	1
Vegetables:			
- Baked Jacket Potatoes	180 - 190	60 - 90	1
- Roast Potatoes	180 - 190	60 - 90	1
Yorkshire Pudding:			
- Large	200 - 210	25 - 40	1
- Individual	210 - 220	15 - 25	1
Roasting Meat, Poultry	See roasting chart.		

## Main oven

### Baking

 Shelf Positions are not critical but ensure that oven shelves are evenly spaced when

more than one is used (e.g. shelf positions 1 and 3)

Food	Temperature [°C]	Approx Cook Time (mins)
Biscuits	180 - 190	10 - 20
Bread	190 - 210	30 - 35
Cakes:		
- Small & Queen	160 - 170	18 - 25
- Sponges	160 - 170	20 - 25
- Madeira	140 - 160	60 - 75
- Rich Fruit	130 - 140	120 - 150
- Christmas	130 - 140	180 - 270
Fish	160 - 180	20 - 30
Fruit Pies, Crumbles	170 - 180	30 - 50
Milk Puddings	140 - 160	60 - 90
Pastry:		
- Choux	180 - 190	30 - 40
- Shortcrust	180 - 190	25 - 35
- Flaky	180 - 190	30 - 40
- Puff	Follow manufacturer's instructions; Reduce the temperature for Fan oven by 20°C	
Plate Tarts	180 - 190	25 - 45
Quiches/Flans	170 - 180	25 - 45
Scones	210 - 230	8 - 12
Roasting: Meat and Poultry	160 - 180	see Roasting Chart

## Roasting

### Roasting dishes

- Use heat-resistant ovenware to roast (please read the instructions of the manufacturer).
- Large roasting joints can be roasted directly in the deep roasting pan or on the oven shelf above the deep roasting pan. (If present)

- Roast lean meats in a roasting tin with a lid. This will keep the meat more succulent.
- All types of meat, that can be browned or have crackling, can be roasted in the roasting tin without the lid.

### Main oven

## Roasting

Meat	Temperature [°C]	Cooking Time
Beef/ Beef boned	160 - 180	20-35 minutes per ½ kg (1lb) and 20-35 minutes over
Mutton/ Lamb	160 - 180	20-35 minutes per ½ kg (1lb) and 20-35 minutes over
Pork/ Veal/ Ham	160 - 180	30-40 minutes per ½ kg (1lb) and 30-40 minutes over

Meat	Temperature [°C]	Cooking Time
Chicken	160 - 180	15-20 minutes per ½ kg (1lb) and 20 minutes over
Turkey/ Goose	160 - 180	15-20 minutes per ½ kg (1lb) and 20 minutes over
Duck	160 - 180	25-35 minutes per ½ kg (1lb) and 25-30 minutes over
Pheasant	160 - 180	35-40 minutes per ½ kg (1lb) and 35-40 minutes over
Rabbit	160 - 180	20 minutes per ½ kg (1lb) and 20 minutes over

## Grilling

**Always use the grilling function with maximum temperature setting**

**Important!** Always grill with the oven door closed

 Always pre-heat the empty oven with the grill functions for 5 minutes.

- Set the shelf in the shelf level as recommended in the grilling table.

- Always set the pan to collect the fat into the first shelf level.
- Grill only flat pieces of meat or fish.

## Top oven

### Grilling

 Adjust shelf position and grill pan grid to suit different thicknesses of food

Food	Grill Time (mins in total)
Bacon Rashers	5- 6
Beefburgers	10 - 20
Chicken Joints	20 - 40
Chops	
- Lamb	15 - 25
- Pork	20 - 25
Fish - Whole Trout/ Makarel	10 -12
Fillets - Plaice/Cod	4 - 6
Kebabs	12 - 18
Kidneys - Lamb/Pig	6 - 10
Sausages	20 - 30
Steaks	
- Rare	4 - 6
- Medium	6 - 8
- Well Done	12 - 15
Toasted Sandwiches	3 - 4

## Defrosting ❄️

- Put the food out of the packaging and set it on a plate on the oven shelf.
- Do not cover with a plate or bowl. This can extend the time to defrost very much.

## Care and cleaning

**⚠ Warning!** Refer to the Safety chapters.

- Clean the front of the appliance with a soft cloth with warm water and cleaning agent.
- To clean metal surfaces use a usual cleaning agent
- Clean the oven interior after each use. Thus you can remove dirt more easily and it does not burn on.
- Clean stubborn dirt with a special oven cleaner.
- Clean all oven accessories (with a soft cloth with warm water and cleaning agent) after each use and let them dry.
- If you have nonstick accessories, do not clean them using an aggressive agents, sharp edged objects or dishwasher. It can destroy nonstick coating!

### **i** **Stainless steel or aluminium appliances:**

Clean the oven door with a wet sponge only. Dry it with a soft cloth.  
Do not use steel wool, acids or abrasive materials as they can damage the oven surface. Clean the oven control panel with the same precautions

### **Shelf Support Rails**

You can remove the shelf support rails to clean the side walls.

- Put the oven shelf in the first shelf level from the bottom.

### **Removing the shelf support rails**

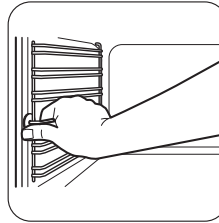

**1** Pull the front of the shelf support rail away from the side wall.

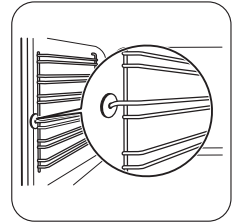

**2** Pull the rear shelf support rail away from the side wall and remove it.

### **Installing the shelf support rails**

Install the shelf support rails in opposite sequence.

**i** The rounded ends of the shelf support rails must point to the front.

### **Oven Ceiling**

You can fold down the heating element on the oven ceiling to clean the oven ceiling easily.

### **Folding down the heating element**

1. Remove the shelf support rails.

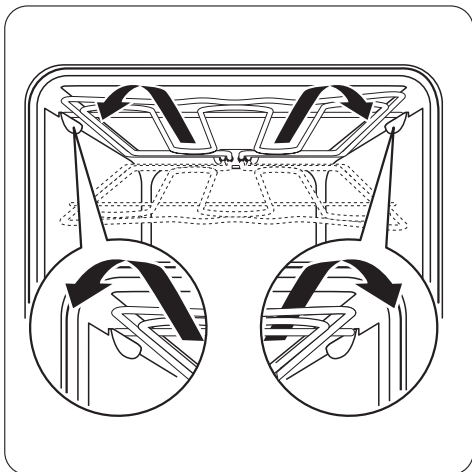

2. Hold the heating element with the two hands at the front
3. Pull it forwards against the spring pressure and out along the support on both sides.
4. The heating element folds down. The oven ceiling is ready to clean.

### Installing the heating element

1. Install the heating element in opposite sequence.

**Important!** Install the heating element correctly on the two sides above the support on the inner wall of the oven.

2. Insert shelf support rails.

### Oven door and glass panels

To clean the oven door remove it.

**Caution!** Be careful when you remove the door from the appliance. The door is heavy!

### Removing the oven door

1. Open the oven door as far as it goes.
2. Lift up clamping levers (A) on the two door hinges fully.

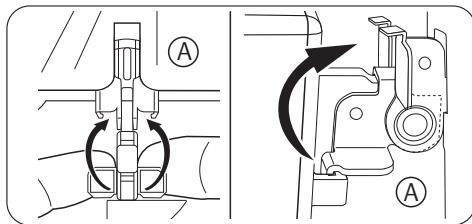

3. Close the oven door until the first position (angle approx. 45°).

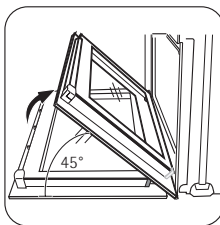

4. Hold of the oven door with one hand on each side and pull it away from the oven at an upwards angle.

**i** Put the oven door with the outer side down on a soft and level surface to prevent scratches.

5. Now you can remove the inner glass panels and clean them. To install the door follow the procedure in reverse.

**i** The oven door has 2, 3 or 4 panels of glass (depends on the model)

### Removing and cleaning the door glasses

1. Hold the door trim (B) on the top edge of the door at the two sides and push inwards to release the clip seal.

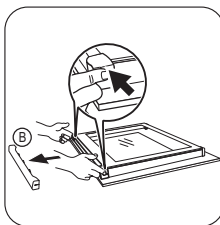

2. Pull the door trim to the front to remove it.

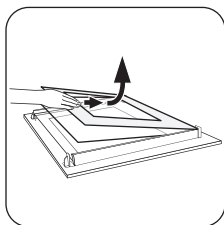

3. Hold the door glass panels on their top edge one by one and pull them upwards out of the guide
4. Clean the door glass panels. To install panels follow the procedure in reverse. Insert the smaller panel first, then the larger.

### Oven lamp

**Warning!** There is a danger of electrical shock!

## What to do if...

**Warning!** Refer to the Safety chapters.

Problem	Possible cause	Remedy
The oven does not heat up.	The appliance is deactivated.	Activate the appliance.
The oven does not heat up.	The clock is not set.	Set the clock.
The oven does not heat up.	The necessary settings are not set.	Make sure that the settings are correct.
The oven does not heat up.	The fuse in the fuse box is released.	Do a check of the fuse. If the fuse is released more than one time, contact a qualified electrician.
The oven lamp does not operate.	The oven lamp is defective.	Replace the oven lamp.
The display shows <b>12.00</b>	There was a power cut.	Set the clock.
Steam and condensation settle on the food and in the oven.	You left the dish in the oven for too long.	Do not keep the dishes in the oven for longer than 15-20 minutes after the cooking ends.

If you cannot find a solution to the problem yourself, contact your dealer or the service centre.

### Before you change the oven lamp:

- Switch off the oven.
- Remove the fuses in the fuse box or switch off the circuit breaker.

**i** Put a cloth on the bottom of the oven for protection of the oven light and glass cover.

### Replacing the oven lamp

1. You can find the lamp glass cover at the back of the cavity. Turn the lamp glass cover counterclockwise to remove it.
2. Clean the glass cover.
3. Replace the oven lamp with applicable 300°C heat-resistant oven lamp.

**Important!** Use the same oven lamp type.

4. Install the glass cover.

The necessary data for the service centre is on the rating plate. The rating plate is on the front frame of the appliance cavity.

We recommend that you write the data here:

Model (MOD.)

.....



Product number (PNC) .....

Serial number (S.N.) .....

## Installation

**Warning!** Refer to the Safety chapters.

**Important!** The built-in unit must meet the stability requirements of DIN 68930.

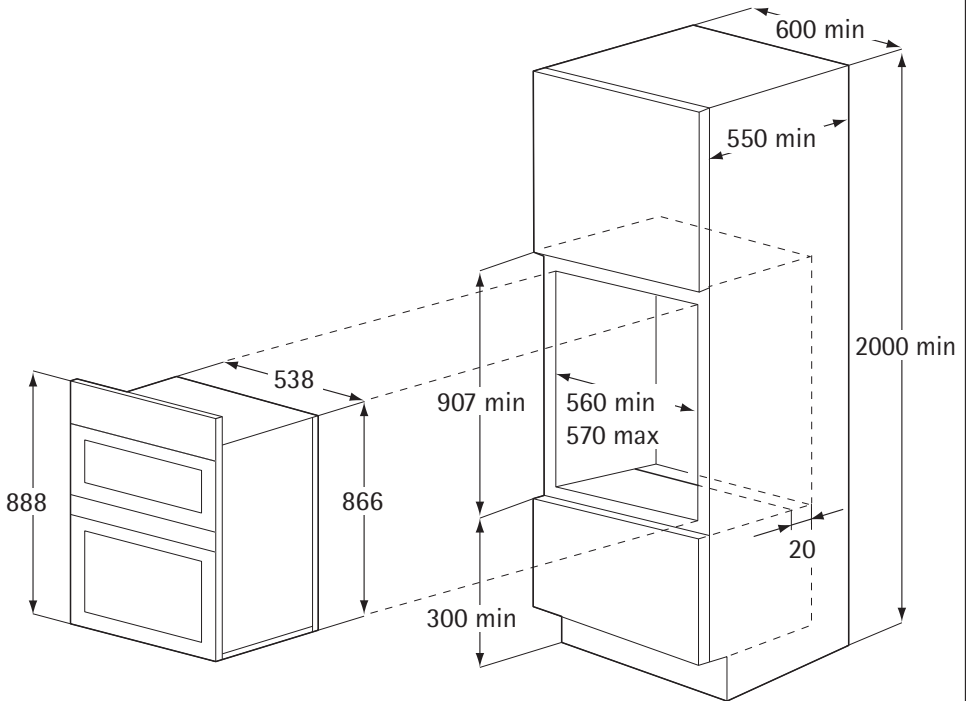

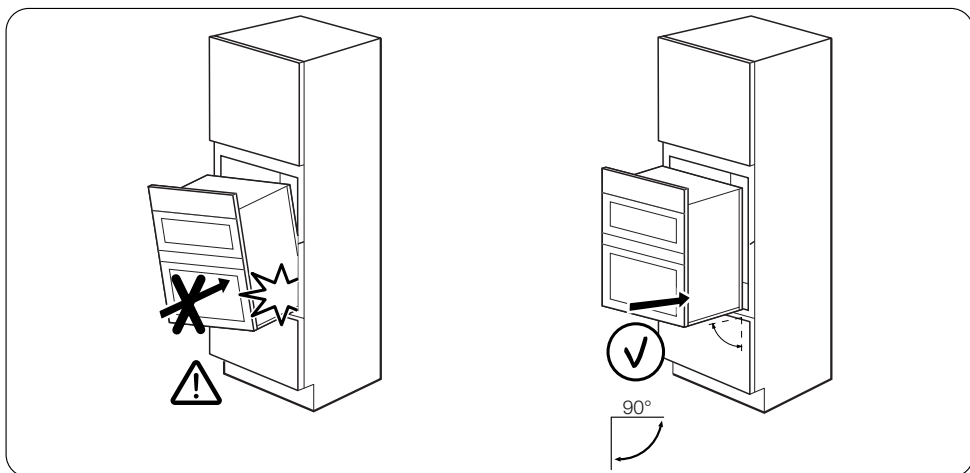
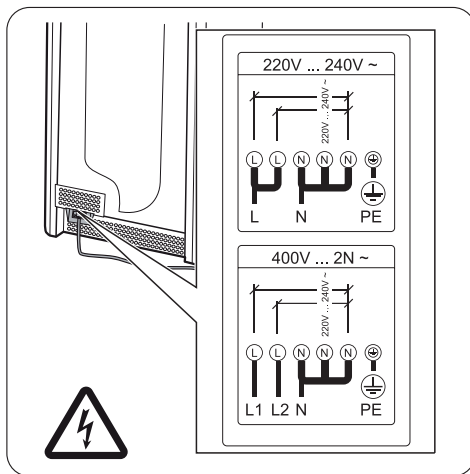
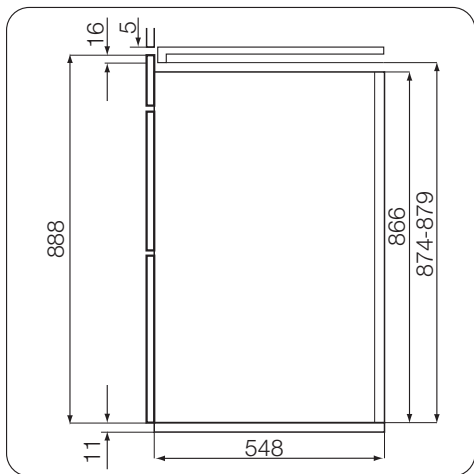

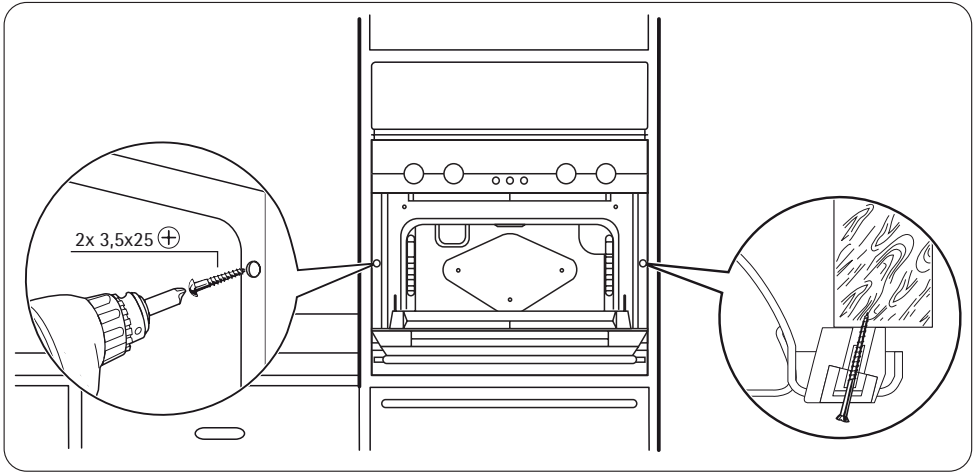

## Environment concerns

The symbol  on the product or on its packaging indicates that this product may not be treated as household waste. Instead it should be taken to the appropriate collection point for the recycling of electrical and electronic equipment. By ensuring this product is disposed of correctly, you will help prevent potential negative consequences for the environment and human health, which could otherwise be caused by inappropriate waste handling of this product. For more detailed

information about recycling of this product, please contact your local council, your household waste disposal service or the shop where you purchased the product.

-  **Packaging material**  
The packaging material is environmentally friendly and recyclable. Plastic parts are marked with international abbreviations such as PE, PS, etc. Dispose of the packaging material in the containers provided for this purpose at your local waste management facility.

## **GREAT BRITAIN & IRELAND - Guarantee/Customer Service**

### Standard guarantee conditions:

We, Electrolux, undertake that if within 12 months of the date of the purchase this Electrolux appliance or any part thereof is proved to be defective by reason only of faulty workmanship or materials, we will, at our option repair or replace the same **FREE OF CHARGE** for labour, materials or carriage on condition that:

- Appliance has been correctly installed and used only on the electricity supply stated on the rating plate.

- Appliance has been used for normal domestic purposes only, in accordance with manufacturer's instructions.
- Appliance hasn't been serviced, maintained, repaired, taken apart or tampered with by person not authorised by us.
- Electrolux Service Force Centre must undertake all service work under this guarantee
- Any appliance or defective part replaced shall become the Company's property.
- This guarantee is in addition to your statutory and other legal rights.

## Exclusions

- Damage, calls resulting from transport, improper use, neglect, light bulbs, removable parts of glass, plastic.
- Costs for calls to put right appliance which is improperly installed, calls to appliances outside United Kingdom.
- Appliances found to be in use within a commercial environment, plus those which are subject to rental agreements.
- Products of Electrolux manufacturer that are not marketed by Electrolux

**Service and Spare Parts.**Please contact your local Service Force Centre: **08445 616**

**616**(Call will be routed to Service Force Centre covering your postcode area). For address of local Service Force Centre and further information, please visit: **www.serviceforce.co.uk**

Before calling out an engineer, please ensure you have read the details under the heading "What to do if... / Troubleshooting". When you contact the Service Force Centre you will need to give the following details: Your name, address and postcode, your telephone number, clear concise details of the fault, model and se-

## European Guarantee

**GB** This appliance is guaranteed by Electrolux in each of the countries listed at the back of this user manual, for the period specified in the appliance guarantee or otherwise by law. If you move from one of these countries to another of the countries listed, the appliance guarantee will move with you subject to the following qualifications:-

- The appliance guarantee starts from the date you first purchased the appliance which will be evidenced by production of a valid purchase document issued by the seller of the appliance.
- The appliance guarantee is for the same period and to the same extent for labour and parts as exists in your new country of resi-

dence for this particular model or range of appliances.

- The appliance guarantee is personal to the original purchaser of the appliance and cannot be transferred to another user.
- The appliance is installed and used in accordance with instructions issued by Electrolux and is only used within the home, i.e. is not used for commercial purposes.
- The appliance is installed in accordance with all relevant regulations in force within your new country of residence.



**Customer Care.**Please contact our Customer Care Department: Electrolux Major Appliances, Addington Way, Luton, Bedfordshire, LU4 9QQ or visit our website at [www.electrolux.co.uk](http://www.electrolux.co.uk)

Customer Care Department,	Tel: (Calls may be recorded for training purposes)
Electrolux	08445 613 613
AEG-Electrolux	08445 611 611
Zanussi-Electrolux	08445 612 612

**For Customer Service in The Republic of Ireland please contact us at the address below:**

Electrolux Group (Irl) Ltd, Long Mile Road, Dublin 12, Republic of Ireland  
Tel: +353 (0)1 4090751, Email: [service.eid@electrolux.ie](mailto:service.eid@electrolux.ie)

		
Albania	+355 4 261 450	Rruga "Kavajës", ish-parku autobuzëve, Tiranë
Belgique/België/Belgien	+32 2 7162444	Raketstraat 40, 1130 Brussel/Bruxelles
Česká Republika	+420 261 302 261	Budějovická 3, Praha 4, 140 21
Danmark	+45 70 11 74 00	Strevelinsvej 38-40, 7000 Fredericia
Deutschland	+49 180 32 26 622	Fürther Str. 246, 90429 Nürnberg
Eesti	+37 2 66 50 030	Pärnu mnt. 153, 11624 Tallinn
España	+34 902 11 63 88	Carretera M-300, Km. 29,900 Alcalá de Henares Madrid
France	08 92 68 24 33 (0.34€/min)	www.electrolux.fr
Great Britain	+44 8445 616 616	Addington Way, Luton, Bedfordshire LU4 9QQ
Hellas	+30 23 10 56 19 70	4, Limnou Str., 54627 Thessaloniki
Hrvatska	+385 1 63 23 338	Slavonska avenija 3, 10000 Zagreb
Ireland	+353 1 40 90 753	Long Mile Road Dublin 12
Italia	+39 (0) 434 558500	Corso Lino Zanussi, 30 - 33080 Porcia (PN)
Latvija	+371 67313626	Kr. Barona iela 130/2, LV-1012, Riga
Lietuva	+370 5 278 06 03	Ozo 10a, LT-08200 Vilnius
Luxembourg	+352 42 431 301	Rue de Bitbourg, 7, L-1273 Hamm
Magyarország	(06-1)467-3205 +361 252 1773	H-1142 Budapest XIV, Erzsébet Királyné útja 87
Nederland	+31 17 24 68 300	Vennootsweg 1, 2404 CG - Alphen aan den Rijn
Norge	+47 81 5 30 222	Risløkkvn. 2 , 0508 Oslo
Österreich	0810 955030	Herziggasse 9, 1230 Wien
Polska	+48 22 43 47 300	ul. Kolejowa 5/7, 01-217 Warszawa
Portugal	+35 12 14 40 39 39	Quinta da Fonte - Edificio Gonçalves Zarco - Q 35 -2774-518 Paço de Arcos
Romania	+40 21 451 20 30	Str. Garii Progresului 2, S4, 040671 RO
Schweiz - Suisse - Svizzera	0848 848 111	Industriestrasse 10, CH-5506 Mägenwil
Slovenija	+38 61 24 25 731	Gerbičeva ulica 110, 1000 Ljubljana
Slovensko	+421 2 32 14 13 34-5	Electrolux Slovakia s.r.o., Electrolux Domáce spotrebiče SK, Galvaniho 17/B, 821 04 Bratislava
Suomi	030 600 5200 Lankapuhelinverkosta 0,0828€/puhelu+0,032€/min Matkapuhelinverkosta 0,192€/min	
Sverige	+46 (0)771 76 76 76	Electrolux Service, S:t Göransgatan 143, S-105 45 Stockholm

		
Türkiye	+90 21 22 93 10 25	Tarlabaşı caddesi no : 35 Taksim İstanbul
Россия	8-800-200-3589	129090 Москва, Олимпийский проспект, 16, БЦ "Олимпик"
Україна	+380 44 586 20 60	04074 Київ, вул.Автозаводська, 2а, БЦ "Алкон"





[www.zanussi.com/shop](http://www.zanussi.com/shop)



8929571 16-A-472012





## Free Manuals Download Website

<http://myh66.com>

<http://usermanuals.us>

<http://www.somanuals.com>

<http://www.4manuals.cc>

<http://www.manual-lib.com>

<http://www.404manual.com>

<http://www.luxmanual.com>

<http://aubethermostatmanual.com>

Golf course search by state

<http://golfingnear.com>

Email search by domain

<http://emailbydomain.com>

Auto manuals search

<http://auto.somanuals.com>

TV manuals search

<http://tv.somanuals.com>