

ZANUSSI

BUILT-IN GAS
DOUBLE OVEN
AND GRILL
ZUG 78

INSTRUCTION BOOKLET

IMPORTANT SAFETY INFORMATION

These warnings are provided in the interests of your safety. Ensure that you understand them all before installing or using the cooker. Your safety is of paramount importance. If you are unsure about any of the meanings of these warnings contact the Customer Care Department. The address is on the back page of this book.

INSTALLATION

- The cooker must be installed according to the instructions supplied. The installation work must be undertaken by a competent person as stated in the Gas Safety (Installation & Use) regulations current edition.
- The installer should check that the cooker is suitable for the gas supply by checking the data badge.
- The cooker must be installed in an adequately ventilated room.
- This cooker is heavy and care must be taken when moving it. Do not try to move the cooker by pulling the door handles.
- All packaging, both inside and outside the cooker must be removed before the cooker is used.
- It is dangerous to alter the specifications or modify the cooker in any way. After installation please dispose of the packaging with due regard for safety and the environment.

CHILD SAFETY

- This cooker is designed to be operated by adults. Young children must not be allowed to tamper with the controls or play near or with the cooker.
- The cooker and accessible parts especially around the grill area become hot when the cooker is in use. Keep children away until it has cooled.

DURING USE

- This cooker has been designed for domestic use to cook edible foodstuffs only, and must not be used for any other purpose.
- Take great care when heating fats and oils as they will ignite if they become too hot.
- Never place plastic or any other material which may melt in or on the oven.
- Do not stand too close to the oven or grill while in use as warm air will exhaust from the grill cavity and the vents on the front frame of the cooker.
- When lighting any burner check that it is lit before leaving the cooker.
When turning off any burner do not leave the cooker until the flame has gone out.
- Do not leave the grill pan handle in position when grilling and ensure oven gloves are used to remove and replace the handle, as it will become hot.
- Always use oven gloves to remove and place food in the oven.

- Ensure that all vents are left unobstructed to ensure ventilation of the oven cavity.
- Never line any part of the cooker with aluminium foil.
- Stand clear when opening the drop down oven doors. Support the doors using the handles until fully open.
- Do not place sealed cans or aerosols inside the oven. They may explode if they are heated.
- Ensure that all control knobs are in the OFF position when not in use.
- Do not stand on the cooker or on the open oven doors.
- Do not hang towels, dishcloths or clothes from the cooker or its handles. They are a safety hazard.

CLEANING AND MAINTENANCE

- The cooker is heavy and care must be taken when moving it.
- This cooker should be kept clean at all times. A build-up of fats or other foodstuffs could result in a fire, especially in the grill pan.
- Do not leave cookware containing foodstuffs, e.g. fat or oil in the cooker in case it is inadvertently switched on.
- Always allow the cooling fan to cool the cooker down before switching off at the wall prior to carrying out any cleaning / maintenance work.
- Only clean this cooker in accordance with the instructions given in this book.

SERVICE

- Repairs should not be carried out by inexperienced persons as this may cause injury or serious malfunction. This cooker should be serviced by an authorised Service Engineer and only genuine approved spare parts should be used. Details of servicing and repair arrangements are supplied on page 39 of this book.

AT THE END OF THE COOKERS LIFE

- When the time comes to dispose of your cooker please contact your local Council Authority. They can arrange to dispose of the cooker in a safe and controlled manner. The number will be in the telephone book.



Please read this instruction book carefully before use and retain for future reference.

CONTENTS

FOR THE USER

Important Safety Information	2	Care and Cleaning	29
Description of the cooker	5	Cleaning Materials	29
Getting to Know Your Oven	6	Cleaning the Outside of the Cooker	29
The Cooling Fan for the Controls	7	Cleaning the Outer and Inner Door	
Location	7	Glass Panels	30
Before Using The Cooker	8	Cleaning the Main Oven	31
Rating Plate	8	Cleaning the Grill / Top Oven Compartment	32
Connecting to the Electricity Supply	8	To Remove the Wirework Runners	32
When First Switching On	8	Cleaning the Shelves, Wirework Runners and Oven Furniture	32
Condensation and Steam	9		
Cookware	9		
The Trivet	9	Care of Stayclean Surfaces	33
Grill and Oven Furniture	10	The Oven Cleaning Cycle	33
		Things to Note	33
The Electronic Timer	11	Hints and Tips	33
The Grill	15	Replacing an Oven Light Bulb	35
Uses of the Grill	15		
How To Light the Grill	15	If Something Doesn't Work	36
Things To Note	15	Guarantee Conditions	38
The Grill Shelf	16	Service and Spare Parts	39
The Grill Pan and Handle	16		
Hints and Tips	17		
Grilling Chart	18		
The Top Oven	19		
Uses of the Top Oven	19		
Preheating	19		
How To Light the Top Oven	19		
Things To Note	19		
To Fit the Top Oven Shelf	20		
Hints and Tips	20		
Top Oven Cooking Chart	21		
The Main Oven	22		
Uses of the Main Oven	22		
Preheating	22		
How To Light the Main Oven	22		
Things to Note	22		
To Fit the Main Oven Shelves	23		
Hints and Tips	23		
Main Oven Cooking Chart	25		
Slowcook Feature	26		
Uses of Slowcook	26		
How To Use Slowcook	26		
Things to Note	26		
Hints and Tips	26		

Please read the whole instruction book before using the cooker. To help you the following symbols will be found in the text.



Safety Instructions



Step by Step Instructions



Hints and Tips

FOR THE INSTALLER

Technical Details	40
Things You Need to Know	41
Warnings	41
Things to Note	41
Getting Things Ready	42
Preparing Cabinet for Fitting Oven	42
Flexible Pipe Installation	43
Making the Electrical Connections	44
Connecting To Electricity Supply	44
Checking Electrical Connections	45
Pressure Testing	46

DESCRIPTION OF THE COOKER

Built in gas double oven



WARNING: THIS COOKER MUST BE EARTHED AND PROTECTED BY A 3 AMP FUSE

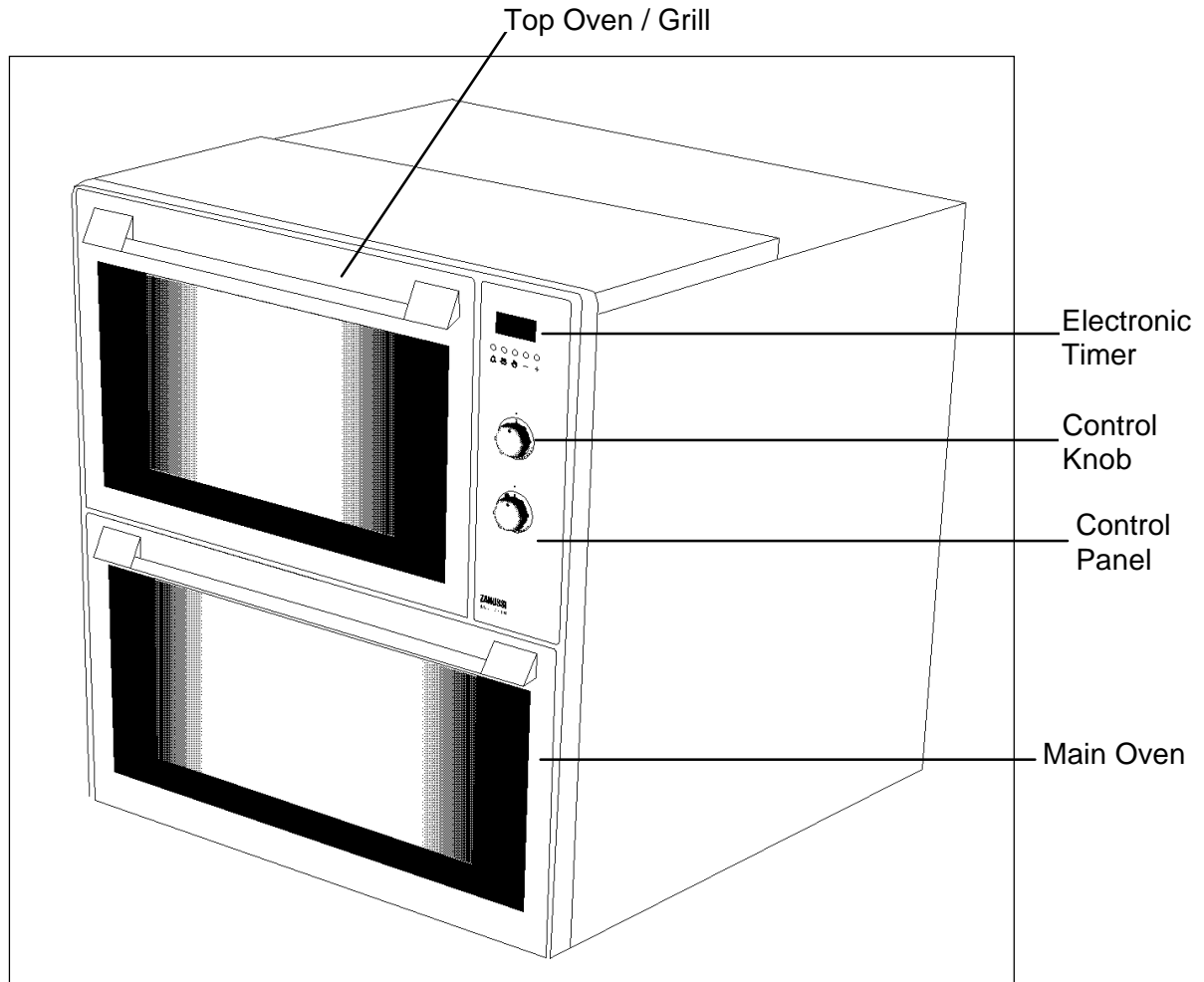

Your built in cooker comprises of a gas oven and grill in the top compartment. The top oven is convenient and economical for mid-week use because of its size.

The main oven is the larger of the two ovens. It is particularly suitable for cooking larger quantities of food. In addition, the Slowcook feature allows you to cook a range of foods over a long period of time at a low temperature.

The Main oven can be automatically controlled by the electronic timer.

GETTING TO KNOW YOUR OVEN

The Control Panel

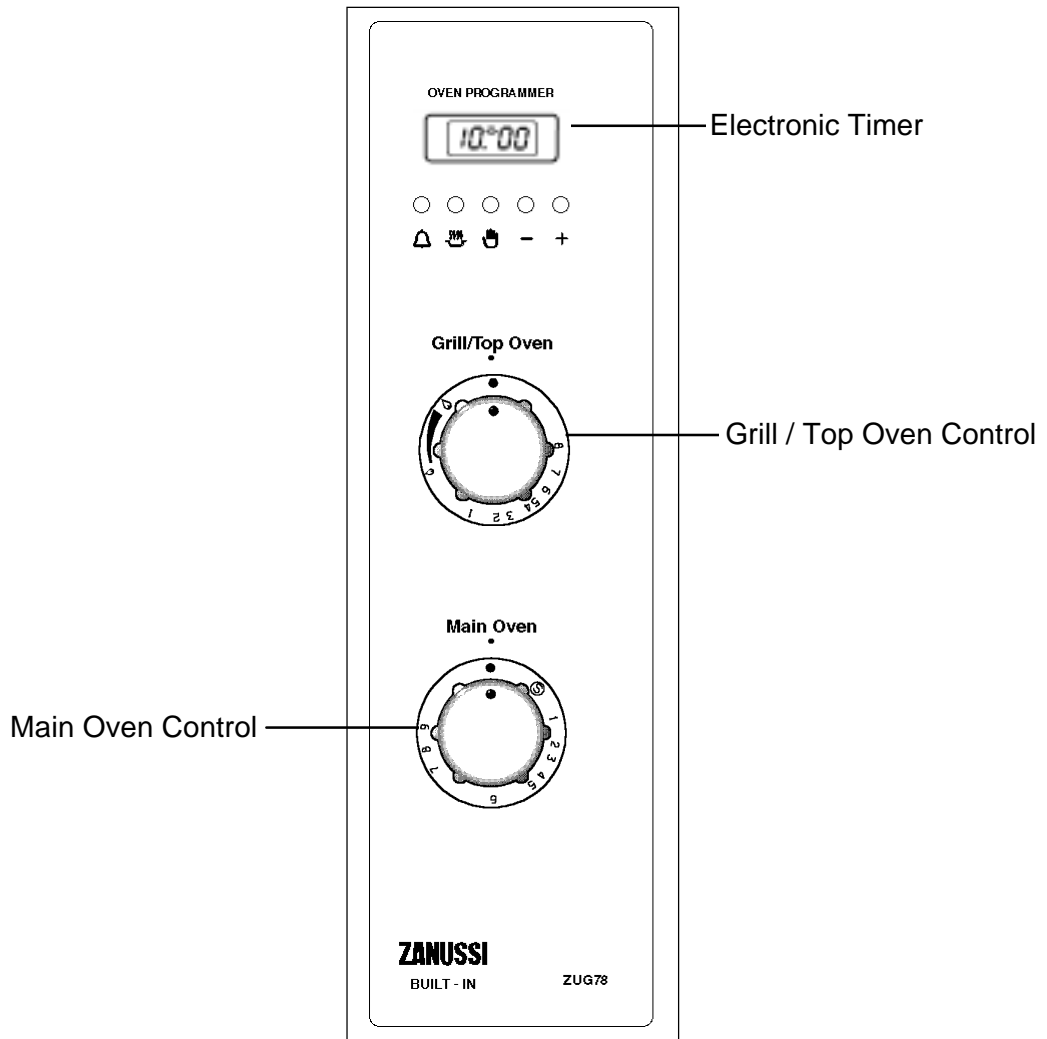

THE COOLING FAN FOR THE CONTROLS

Your cooker has a cooling fan fitted behind the controls to prevent them from overheating. The cooling fan will come on immediately when the top oven or grill is switched on and after a short time when the main oven is in use. The cooling fan may run on after the ovens or grill are turned off for a period of time to cool the cooker down. It may continue to switch on and off until the cooker is cool.



Always allow the cooling fan to cool the cooker down before switching off at the wall prior to carrying out any cleaning or maintenance work.

NOTE

The action of the cooling fan will depend on how long the ovens or grill have been used and at what temperature. It may not run on where the grill or oven has only been used for a short time.



Do not stand too close to the grill or oven when in use as warm air will exhaust from the grill cavity and oven vents.

LOCATION



All gas ovens require adequate ventilation. The room the oven is fitted in must have a good air supply that meets the standard BS 5440 Part 2 (current edition). Your installer will tell you if you are not sure.

The oven may be placed in a kitchen, kitchen/diner or bedsit but not in a bathroom or shower room. It should not be installed in a bedsit smaller than 20m³. L.P.G. cookers **MUST NOT** be installed below ground level, i.e. in a basement.

The use of a gas cooking appliance results in the production of heat and moisture in the room in which it is installed. Ensure that the kitchen is well ventilated: keep natural ventilation holes open or install a mechanical ventilation device (mechanical extractor hood).

Prolonged intensive use of the appliance may call for additional ventilation, for example opening of a window, or more effective ventilation, for example increasing the level of mechanical ventilation where present.

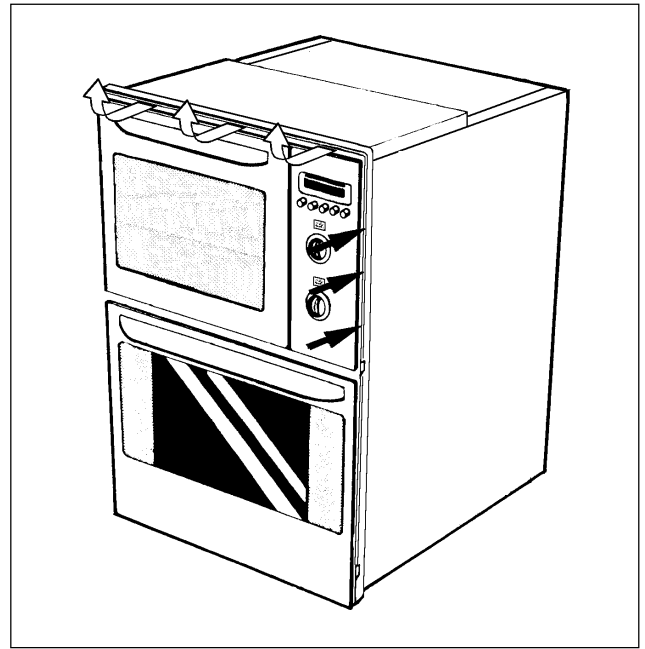

BEFORE USING THE COOKER

RATING PLATE

Record the model, serial and product numbers of your cooker on the back page of this instruction book for future reference. You can find these numbers on the rating plate on the front frame of the cooker upon opening the top oven door.

The cooker must be protected by a suitably rated fuse or circuit breaker. The rating of the cooker is given on the rating plate.

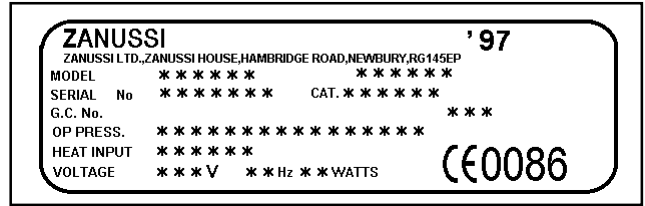

CONNECTING TO THE ELECTRICITY SUPPLY

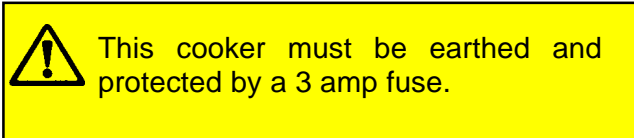

The plug supplied with the oven can be fitted directly to a suitable three pin earthed socket.

If you have to change the fuse replace it with a 3 amp fuse which has been ASTA approved to BS 1362.

Do not use the plug until you have put the fuse cover back on. If you cut the plug off dispose of it safely as it will be a shock hazard if it is inserted into a 13 amp socket elsewhere in the house.

If the ignition system doesn't work there may be a fault with the electrical supply. First, check the socket by trying out another piece of electrical equipment in it, if that works correctly renew the fuse in the plug.

If the fuse keeps failing there is a fault in the oven which must be put right. Do not use a fuse with a rating higher than 3 amps. Do not carry out other electrical work. Unplug the oven and tell your installer.

WHEN FIRST SWITCHING ON

The timer must be set to manual operation before the main oven can be operated. This must be done whenever the cooker is switched off at the wall or when there has been a power failure. For instructions on how to set the timer see page 11.

The Top Oven and the Grill are not controlled by the electronic timer.

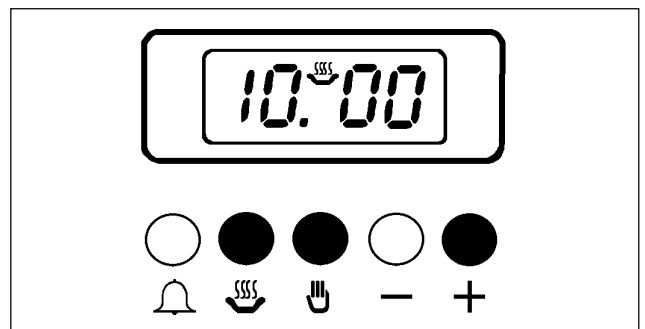

PREPARING TO USE YOUR COOKER

Wipe over the grill compartment and oven base with a soft cloth and hot soapy water and wash the grill and oven furniture before use.

The grill and ovens should be heated without food to burn off any residue from the grill and oven surfaces. To do this run the ovens at Gas Mark 7 for approximately 30 minutes.

The procedure should be repeated with the grill for approximately 5 - 10 minutes.

During this period an unpleasant odour may be emitted, it is therefore advisable to open a window for ventilation.

CONDENSATION AND STEAM

When food is heated it produces steam in the same way as a boiling kettle does. The ovens are vented to allow some of this steam to escape. However, always stand back from the cooker when opening the oven doors to allow any build up of steam or heat to release. If the steam comes into contact with a cool surface on the outside of the cooker, e.g. a trim, it will condense and produce water droplets. This is quite normal and is not caused by a fault on the cooker.

To prevent discolouration occurring, regularly wipe away condensation and any soilage from the cooker surfaces.

COOKWARE

Baking trays, dishes etc., should not be placed over the oven burner. This will damage the oven as well as the ovenware.

Do not use baking trays larger than 30cm x 30cm (12" x 12") as they will restrict the circulation of heat and may affect performance. Advice on the effect of different materials and finishes of bakeware is given in 'Hints and Tips' in the appropriate oven section.

If using a baking tray larger than 30cm x 25cm (12" x 9") in the top oven you may need to turn it round during cooking.

THE TRIVET

When roasting we recommend that you use the trivet in the meat tin. Fat and meat juices will drain into the meat tin below and can be used to make gravy. The trivet also prevents splashes of fat from soiling the oven interior.

Note. The meat tin should not be placed on a heated hotplate as this may cause the enamel to crack.

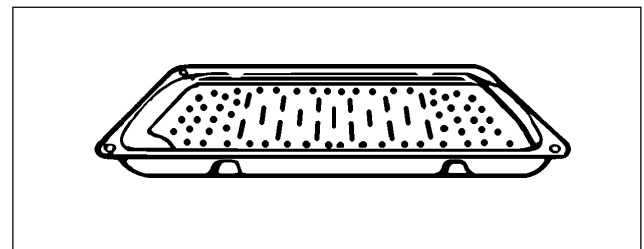
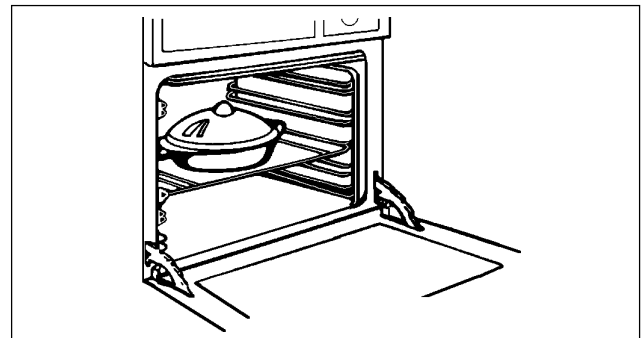
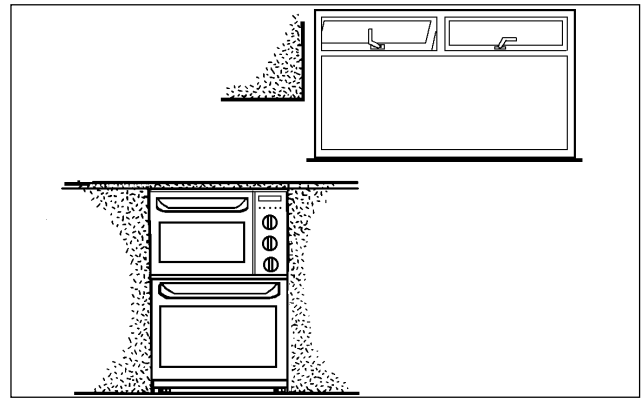

GRILL AND OVEN FURNITURE

The following items of oven furniture have been supplied with the cooker.

1 grill pan



1 grill pan handle

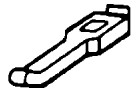

1 grill pan grid

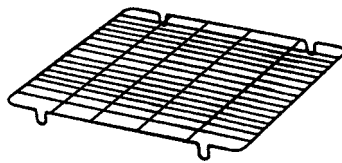

1 trivet

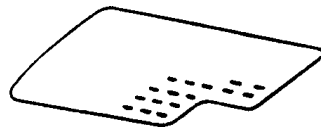

1 meat tin

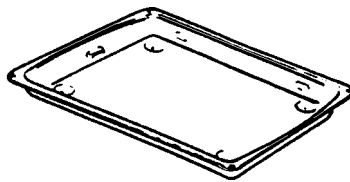

2 shelves for main oven cooking

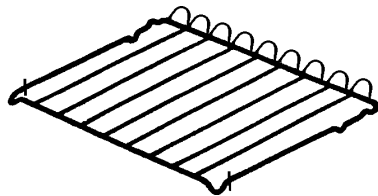

1 shelf for grilling and top oven cooking

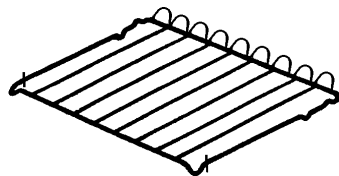



Scuffing of the Stayclean sides and back panel by the oven furniture pack may occur during transit.

These marks will disappear after the oven has been used for the first time.

THE ELECTRONIC TIMER



The electronic timer can indicate the time of day, operate as a minute minder and automatically time the main oven.

- A Auto Symbol (automatic cooking)
-  Bell Symbol (minute minder)
-  Cookpot Symbol (manual cooking)

Please note that this is a 24 hour clock, for example 2pm is shown as 14.00.

If the oven is switched off on the wall or there is loss of power the clock will stop and you will not be able to use the cooker. When you first switch the electricity supply on, the timer display will flash.

TO SET THE TIME OF DAY

1. Press buttons  and  together. Release the buttons.
2. Within 5 seconds press the + button until the time of day shows in the display.

The cookpot symbol () will be showing.

THE MINUTE MINDER

1. Press and release the  button.
2. Within 5 seconds press the + button until the display shows the time you want.

Our diagram shows the timer set to 5 minutes. After a few seconds the time of day will show in the display.

When you are using the minute minder you can check the number of minutes remaining by pressing the  button.

At the end of the timed period an alarm will sound. Switch off the alarm by pressing the  button.

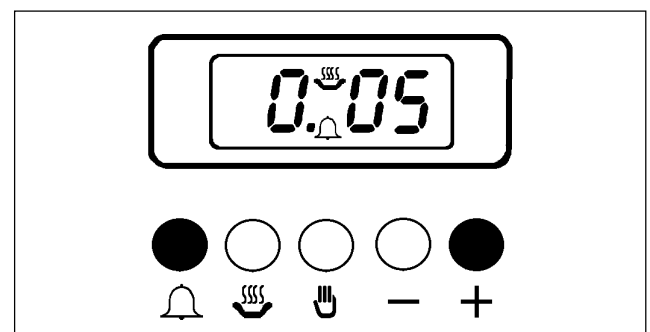
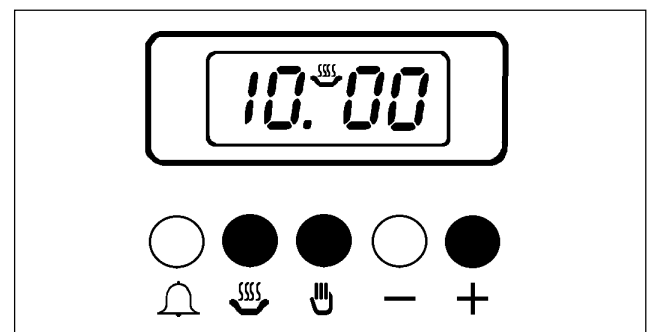
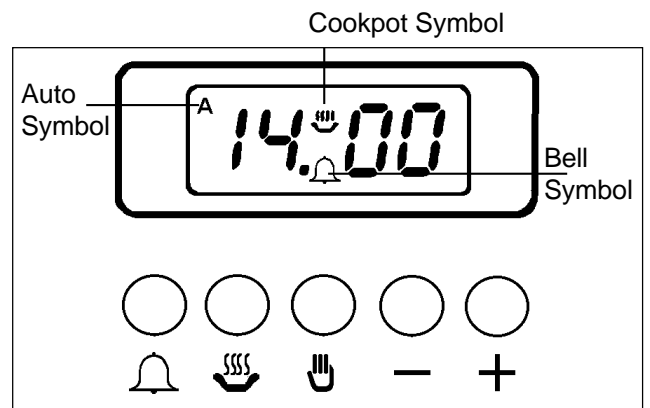

After a few seconds the time of day shows in the display.



AUTOMATIC TIMER CONTROL

The automatic timer can be used with the main oven only.

TO SWITCH THE MAIN OVEN ON AND OFF AUTOMATICALLY

1. Ensure the clock is showing the correct time of day.
2. Place food in the main oven.
3. Set the length of time you want the food to cook for by pressing and releasing the  button and then pressing the + button until the correct cooking time is displayed. This must be completed within 5 seconds of pressing the  button.

The maximum cooking time is 23 hours 59 minutes.

The Cookpot and Auto symbols will show in the display. Our diagram shows the cooking time set for 2 hours 30 minutes.

After a few seconds the time of day shows in the display.

4. To set the time you want the food to be cooked by, press and release the  button. This will show you the earliest possible stop time.

If this is different to the time you want the food to be cooked by, press the + button within 5 seconds until the correct stop time shows in the display. Our diagram shows the food is to be cooked by 18.00 hours (6.00pm). After a few seconds the time of day shows in the display and the Cookpot symbol goes out.

The 'Stop' time must not be more than 23 hours 59 minutes from the time of day. For example, if the time of day is 09.00 hours (9.00am) the latest 'Stop' time will be 08.59 (8.59am) the next day.

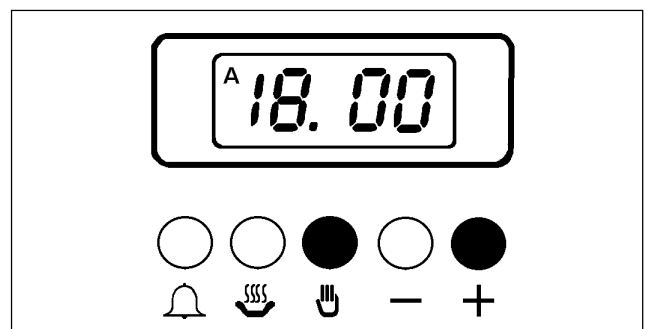
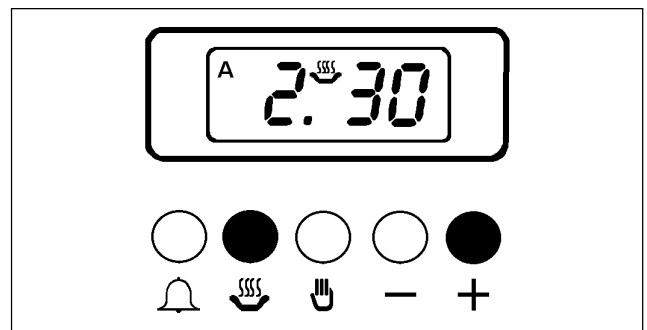



5. Turn the oven control to mark 9 then to the required setting.

The clock will work out what time the oven will switch itself on and will switch the oven off at the end. An audible signal will sound when cooking is complete. To cancel the alarm, see below.

RETURNING THE COOKER TO MANUAL OR TO CANCEL AN AUTOMATIC PROGRAMME

Once automatic cooking is complete an alarm will sound and the Auto symbol will flash to remind you that the oven needs to be set for manual operation.

1. To do this press buttons  and  together. After a few seconds the timer will show the time of day. The cookpot will show in the display and the oven will switch on again.
2. Turn off the oven control.

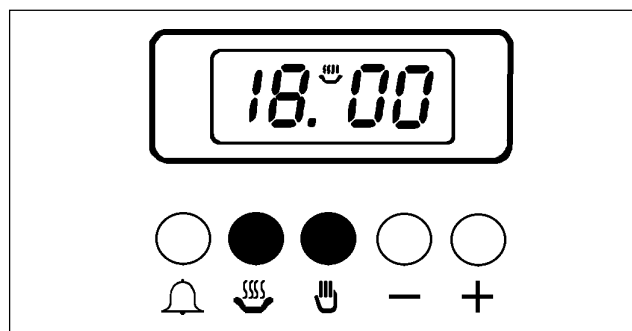

TO SET THE TIMER TO SWITCH OFF ONLY

This is useful if you want to begin cooking immediately but have the Main oven switch off whilst you are out.

1. Ensure the clock is showing the correct time of day.
2. Place food in the oven.
3. Set the length of time you want the food to cook for. Press and release the  button and then within 5 seconds press the + button until the correct cook time is showing.



Our diagram shows the timer set for 2 hours 30 minutes.

After a few seconds the time of day shows in the display.

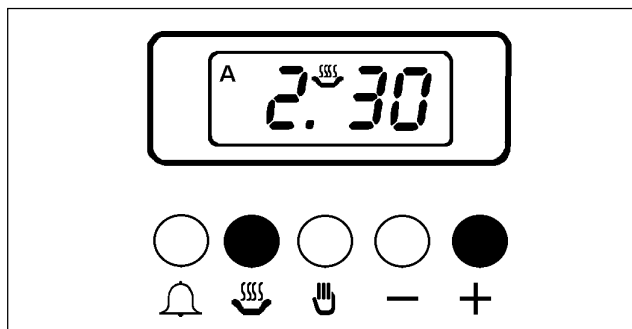
4. Turn the control to mark 9 then to the required setting. If you want to check the time the oven will switch off simply press the  button and the 'Stop' time will be displayed.



At the end of the cooktime the oven will switch off, the alarm will sound and the auto symbol will flash.

5. To cancel and return to manual operation press buttons  and  together.

6. Turn off the oven control.

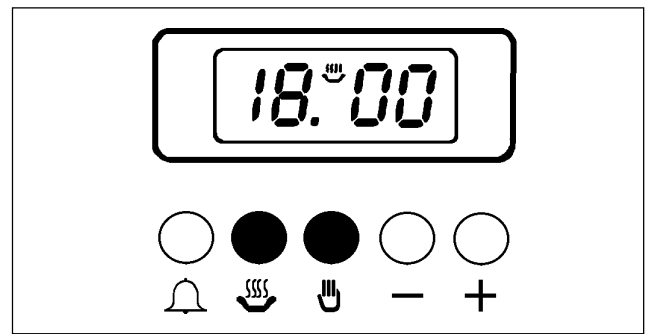

TO CHANGE THE TONE OF THE ALARM

The timer has three different tones to the alarm. You can change the sound of the alarm if you wish.

1. Ensure the clock shows the correct time of day.

2. Press the  button to change the sound of the alarm.

You will hear each of the three tones with each press of the button. Keep pressing the button until you hear the tone you prefer.

The next time the minute minder or timer is used the tone you selected will sound.

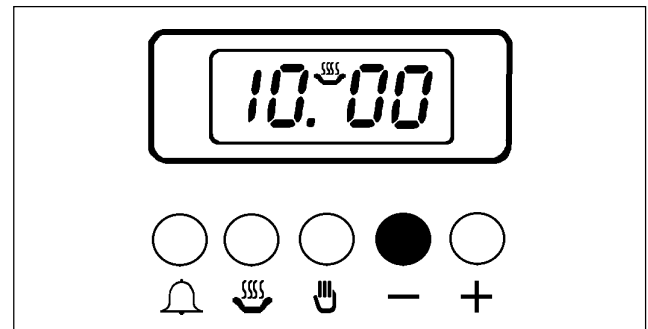

THE GRILL



WARNING - Accessible parts become hot when the grill is in use. Keep children away.

USES OF THE GRILL

The grill is situated in the Top oven compartment.

The grill gives variable heat settings. Use the high setting for foods that cook quickly such as toast and the lower setting to cook thicker foods such as chicken after it has been browned on the high setting.

HOW TO LIGHT THE GRILL

1. Open the Grill / Top Oven door.
2. Push in the grill / top oven control and turn it clockwise to the highest setting. This is shown by a large flame symbol.
3. Adjust the setting as required.
4. Place grill pan with food under the grill.



The grill door must be left open when grilling.

Check that the grill burner is lit before you leave the cooker.

TO TURN OFF THE GRILL BURNER

1. Push in the control knob and turn it to the Off position. This is shown by a large dot.

THINGS TO NOTE

- The cooling fan for the controls will operate as soon as the grill control is turned. For more information on the operation of the cooling fan turn to page 7.
- The oven light will illuminate.
- If the oven door is closed whilst the grill burner is lit, it will go out. The burner will automatically re-light when the door is opened.
- Always light the burner before placing food under the grill.

GRILL / TOP OVEN

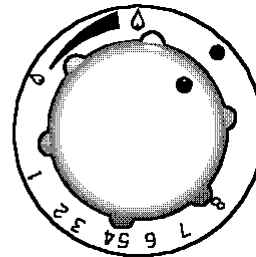

GRILL / TOP OVEN

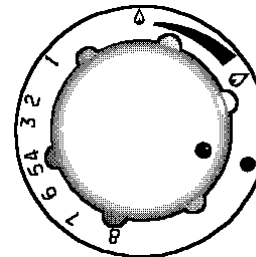

GRILL / TOP OVEN

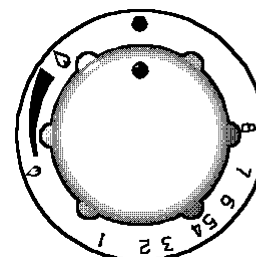

THE GRILL SHELF

The grill shelf can be used in one of three positions. Shelf positions are counted from the top downwards.

The shelf should be fitted with the straight rods uppermost on the frame and the forms towards the back of the oven. If not fitted correctly the anti-tilt and safety stop mechanism will be affected.

When using the grill pan in positions 2 and 3 the shelf must be withdrawn before the pan can be located or removed.



Ensure the grill pan is properly located.

THE GRILL PAN AND HANDLE

The grill pan has a removable handle.

To insert the handle, press the button on the handle with the thumb and pivot the handle slightly upwards inserting the lip into widest part of the bracket. Move the handle towards the left, lower into position and release the button.



Ensure the handle is positively located.

To remove the handle, press the button on the handle with the thumb and pivot the handle slightly upwards and towards the right to remove from the bracket.



Protect your hands when removing the grill pan handle.

Always remove the grill pan handle during grilling.

To correctly locate the grill pan on the shelf, ensure that the cut out on the underside of the handle bracket locates over the front bar of the shelf.

To check the progress of the food being grilled, the grill pan should be withdrawn on the shelf to attend to food during cooking.



Ensure that you support the grill pan when it is withdrawn.

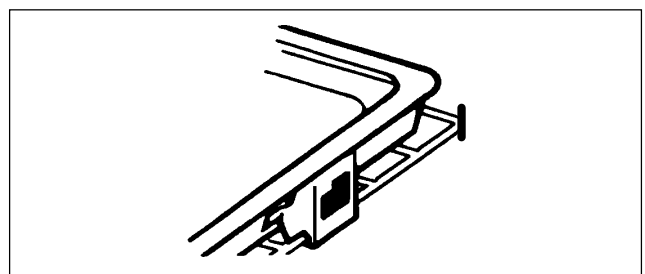
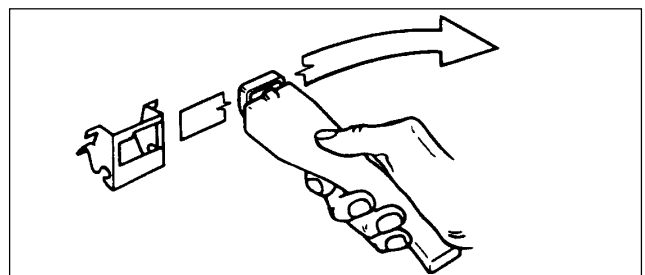
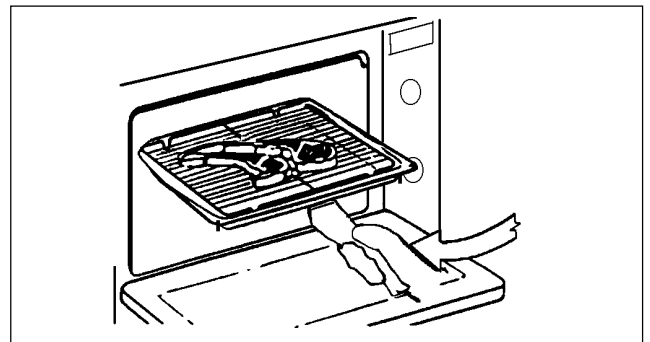
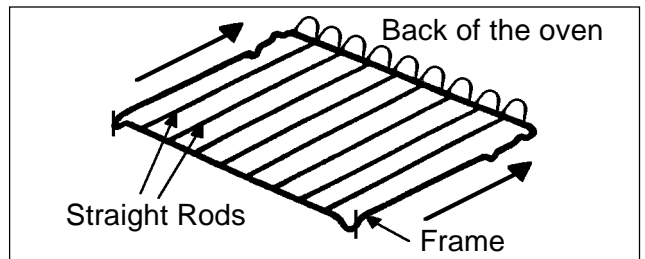
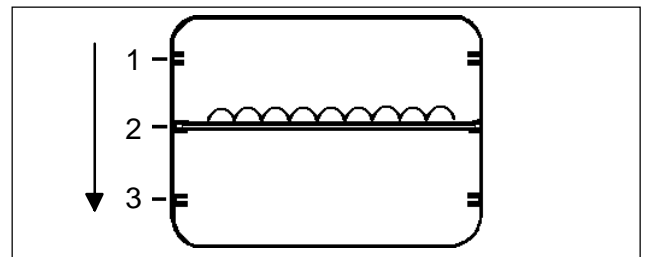

i HINTS AND TIPS

- Most foods should be placed on the grilling grid in the grill pan. This allows maximum circulation of air by raising the food out of fats and juices. Foods such as fish, liver and kidneys may be placed directly on the trivet in the grill pan if preferred.
- The grilling grid is reversible. Adjust the grid height and grill pan runner position to allow for different thicknesses of food. Position the food close to the burner for faster cooking and further away for more gentle cooking.
- Food should be thoroughly dried before grilling to minimise splashing. Brush lean meats and fish lightly with a little oil or melted butter to keep them moist during cooking.
- The food should be turned over during cooking as required. Do not use the grill to keep food warm as it will continue to cook the food.
- The grill door must be left open when grilling. For convenience the grill door can be left ajar.
- You may wish to preheat the grill on full setting for a few minutes before sealing steaks or browning food.
- The grill compartment can be used to warm plates when the main oven is on. Do not place plates to warm under the grill when it is lit as this may damage the plates.

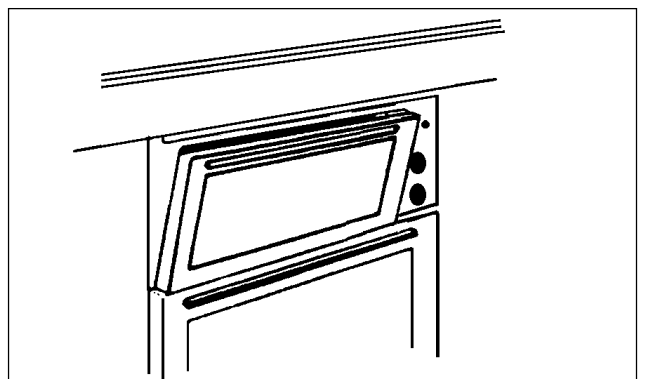
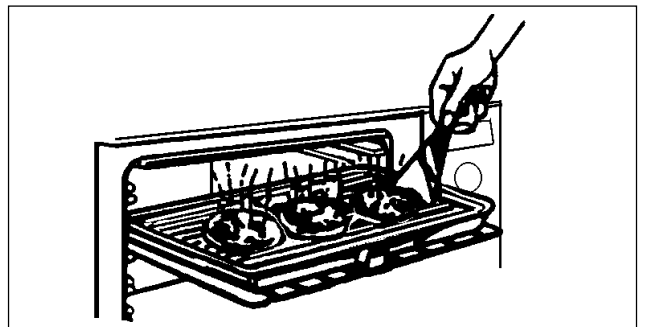
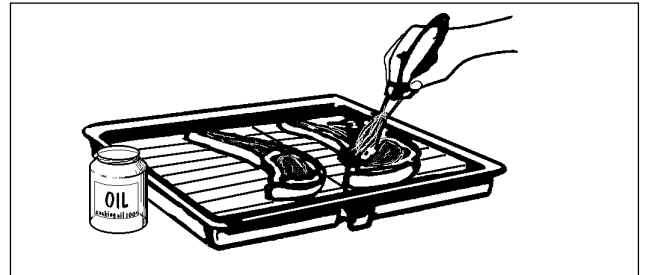
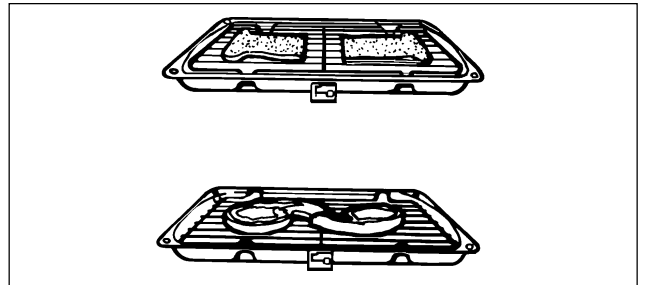
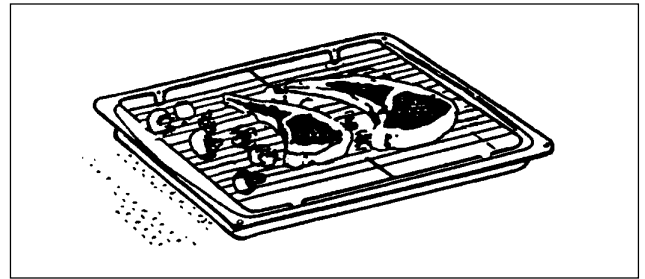

- Place food towards the centre of the grilling grid. If food is outside this area it may require rotating during cooking. Food such as tomatoes and mushrooms requiring gentle heat should be placed towards the edge of the grid.

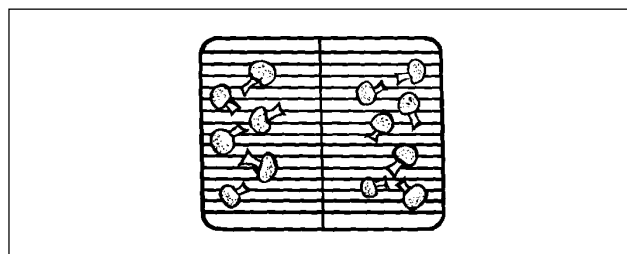

- Place foods such as Shepherds pie and cauliflower cheese on the grill shelf to brown.

GRILLING CHART

The chart below gives recommended cooking times and shelf positions. Remember that these are a guide and should be adjusted to suit personal taste.

Note

Shelf positions are counted from the top downwards.

FOOD	GRILL TIME (Min)	SHELF	GRID POSITION
Bacon Rashers	2 - 3 each side	1	High
Beefburgers	6 - 10 each side	1	Low
Chicken Joints	15 - 20 each side	2	High
Chops - Lamb	7 - 10 each side	1	Low
- Pork	10 - 15 each side	1	Low
Fish - Whole Trout / Mackerel	8 - 12 each side	1	Low
Fillets - Plaice / Cod	4 - 6 each side	1	Low
Kebabs	10 - 15 each side	1	Low
Kidneys - Lamb	4 - 6 each side	1	Low
Pig	8 - 10 each side	1	Low
Liver - Lamb / Pig	5 - 10 each side	1	Low
Sausages	10 - 15 turn as required	1	Low
Steaks - Rare	3 - 6 each side	1	High
Medium	6 - 8 each side	1	High
Well Done	7 - 10 each side	1	High
Browning e.g. au gratin, lasagne, shepherd's pie	3 - 5 mins	2	-

THE TOP OVEN

USES OF THE TOP OVEN

The top oven is the smaller of the two ovens. It is convenient for mid-week meals where smaller quantities or convenience foods are being cooked. It is important to refer to the top oven cooking chart as a guide to shelf positions and gas mark settings as these may differ from previous cookers you may have used.

PREHEATING

It is not necessary to preheat the oven for casseroles.

For recipes needing high temperatures such as bread, pastries, scones, soufflés etc. best results are achieved if the oven is preheated for 20 minutes.

When cooking or reheating frozen or chilled food read the instructions on the packaging.

HOW TO LIGHT THE TOP OVEN

1. Open the oven door.
2. Push in and turn the top oven / grill control to the left to Gas mark 8.
When the burner has lit there will only be small flames at first.
3. Adjust the control to the required Gas mark setting.
4. Wait until the burner has a large flame.
5. Close the oven door.

THINGS TO NOTE

- The cooling fan for the controls will operate as soon as the top oven / grill control is turned. See page 7 for more information on the operation of the cooling fan.
- The oven light will illuminate.
- The top oven cannot be controlled by the automatic timer.



Do not place cookware over the oven burner. This will damage the oven and ovenware.

TO TURN OFF THE TOP OVEN

1. Push in and turn the top oven / grill control to the Off position. This is shown by a large dot.

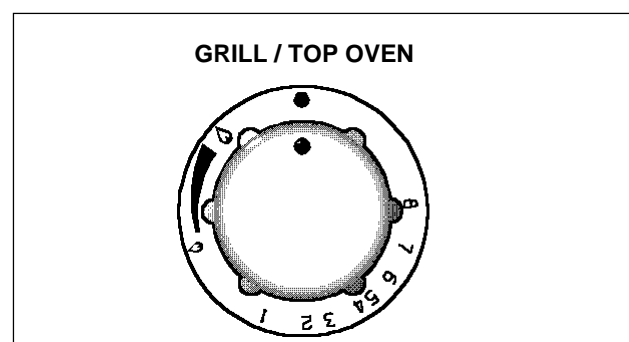
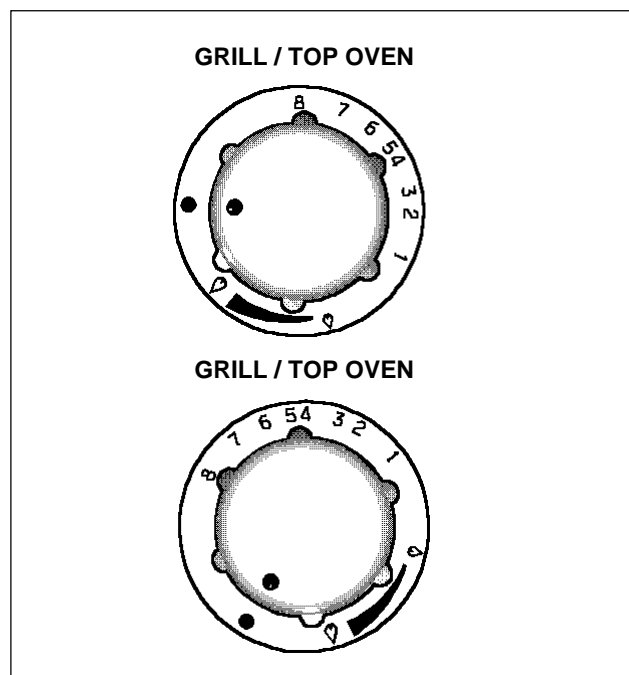

TO FIT THE TOP OVEN SHELF

There are 3 shelf positions in the top oven. Shelf positions are counted from the top downwards.

The shelf should be fitted with the straight rods uppermost on the frame and the forms towards the back of the oven.

If not fitted correctly the anti-tilt and safety stop mechanism will be affected.

HINTS AND TIPS

- There are zones of heat within the oven. The temperature in the middle is the gas mark you have chosen. The top of the oven is slightly hotter and the lower shelf slightly cooler.
- The base of the oven can be used to warm plates.
- You can only cook on one shelf when using the top oven.
- There should always be at least 2.5cm (1") between the top of the food and the grill burner. This gives best cooking results and allows room for rise in yeast mixtures, Yorkshire puddings etc. When cooking cakes, pastry, scones bread etc., place the tins or baking trays centrally on the shelf.
- Leave a gap of 13mm (½") between all dishes and the oven sides so the heat can circulate properly.
- Do not push dishes too far back as it will burn if it overhangs the burner flames.
- If you use a baking tray larger than the recommended size of 12" x 9", (30cm x 25cm) you may need to turn it around during cooking.
- Where a larger quantity of food is to be cooked we recommend you use the main oven.
- The material and finish of the baking tray and dishes will affect the degree of base browning of the food. Enamelware, dark, heavy or non-stick utensils increase base browning. Shiny aluminium or polished steel trays reflect the heat away and give less base browning.

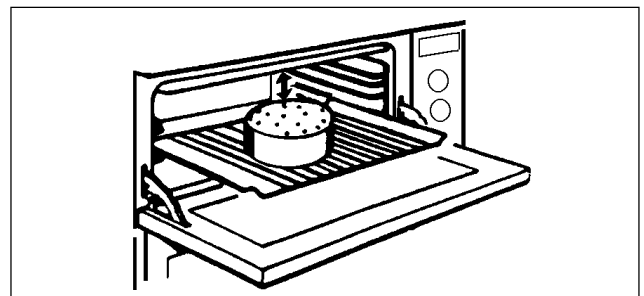
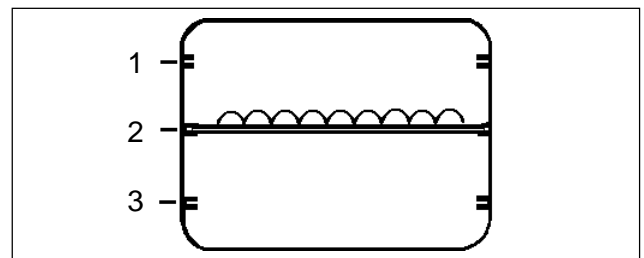
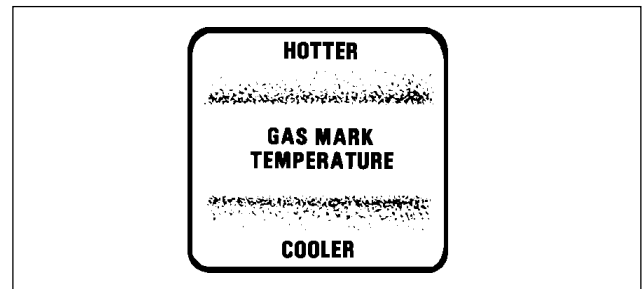
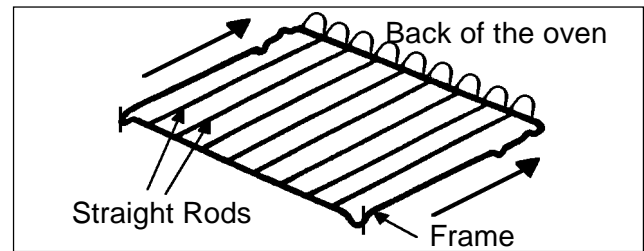
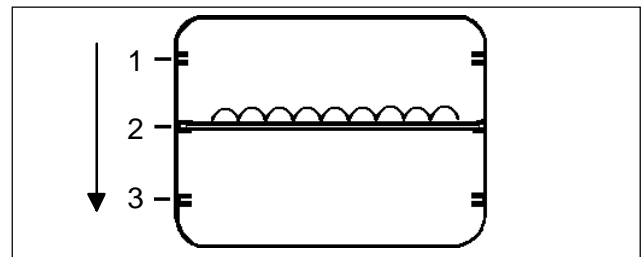

- For economy leave the door open for the shortest possible time, particularly when placing food into a pre-heated oven.

- When roasting we recommend that you use the trivet in the meat tin. Fat and meat juices will drain into the meat tin below and can be used to make gravy. The trivet also prevents splashes of fat from soiling the oven interior.

Note. The meat tin should not be placed on a heated hotplate as this may cause the enamel to crack.

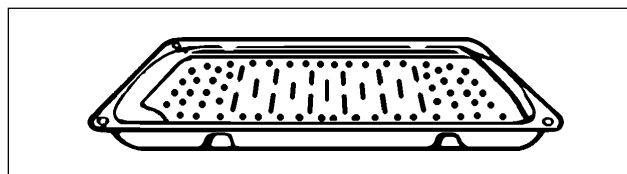
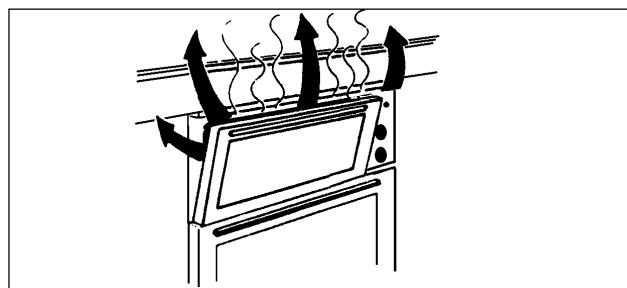

TOP OVEN COOKING CHART

The Gas mark settings are intended as a guide only. It may be necessary to increase or decrease the settings to suit individual preferences and requirements.

Note: Shelf positions are counted from the top downwards

FOOD	SHELF POSITION	GAS MARK SETTING
Viennese Biscuits	3	7
Bread	2	7
Bread Rolls / Buns	2	7
Cakes: Small & Queen	2	5
Sponges	2	4
Victoria Sandwich	2	4
Madeira	2	4
Rich Fruit	2	2
Christmas	3	2
Gingerbread	3	2
Meringues	3	1
Flapjack	2	5
Shortbread	2	2
Baked Custard	2	3
Casseroles : Beef / Lamb	3	3
Chicken	3	4
Convenience Foods	2	According to Manufacturers Instructions
Fish	2	5
Fish Pie - potato topped	2	7
Fruit Pies, Crumbles	2	6
Milk Puddings	2	2
Pasta / Lasagne etc.	2	6
Pastry : Choux - Eclairs/profiteroles	2	4
Flaky / Puff pies	2	7
Shortcrust -		
Mince pies	2	5
Meat pies	2	6
Quiche, Tarts, Flans	2	6
Roast Meat / Poultry	3	5
Scones	2	7
Shepherds Pie	2	7
Soufflés	2	5
Vegetables : Baked Jacket Potatoes	2	5
Roast Potatoes	2	6
Yorkshire Puddings - large	2	7
- individual	2	7

THE MAIN OVEN

USES OF THE MAIN OVEN

The main oven is particularly suitable for cooking larger quantities of food. The main oven also includes a Slowcook feature. It is important to refer to the main oven cooking chart as a guide to shelf positions and gas mark settings as these may differ from previous cookers you may have used.

PREHEATING

It is not necessary to preheat the oven for casseroles.

For recipes needing high temperatures such as bread, pastries, scones, soufflés etc. best results are achieved if the oven is preheated for 20 minutes.

When cooking or reheating frozen or chilled food read the instructions on the packaging.

HOW TO LIGHT THE MAIN OVEN

1. Open the oven door.
2. Push in the main oven control and turn it to gas mark 9.
3. Adjust the control to the required gas mark setting.
4. Wait until the burner has a large flame.
5. Close the oven door.

THINGS TO NOTE

- The oven light will come on when the oven control is turned.
- The cooling fan for the controls may operate after a time. See page 7 for further details on the operation of the cooling fan.
- If an automatic programme has been set, the oven light does not come on until the cook time begins.



Do not place cookware over the oven burner. This will damage the oven and ovenware.

HOW TO TURN OFF THE MAIN OVEN

1. Push in the control knob and turn it to the Off position. This is shown by a large dot.

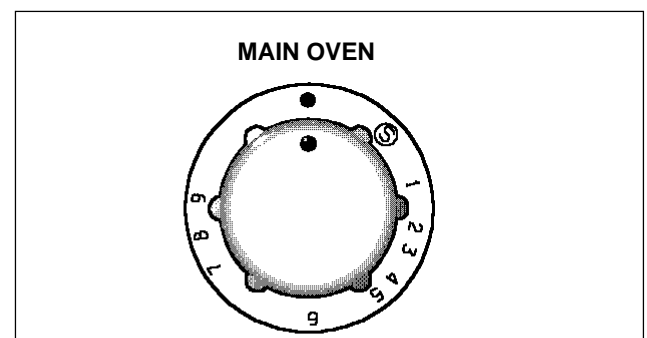
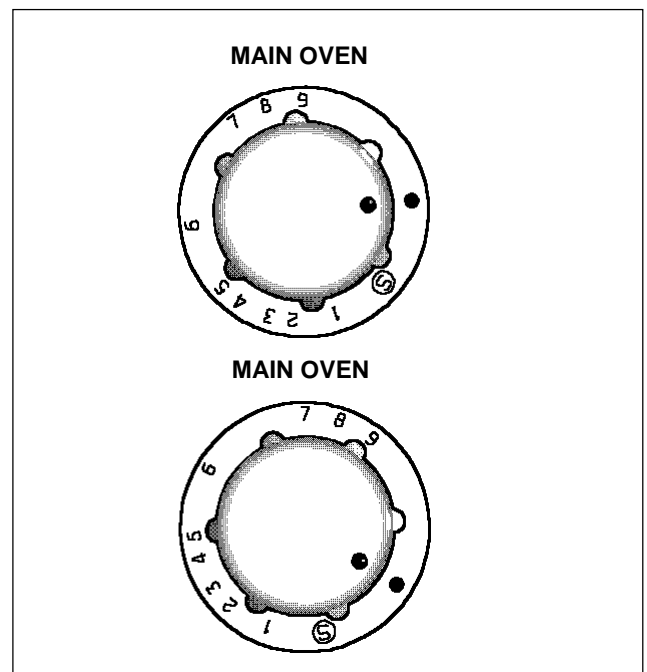

TO FIT THE MAIN OVEN SHELVES

There are 14 shelf positions in the main oven. Shelf positions are counted from the top downwards.

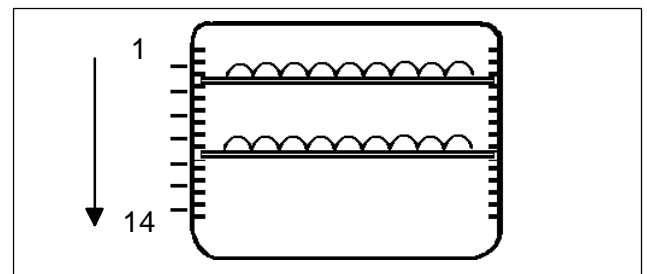

The shelves should be fitted with the straight rods uppermost on the frame and the forms towards the back of the oven. If not fitted correctly the anti-tilt and safety stop mechanism will be affected.

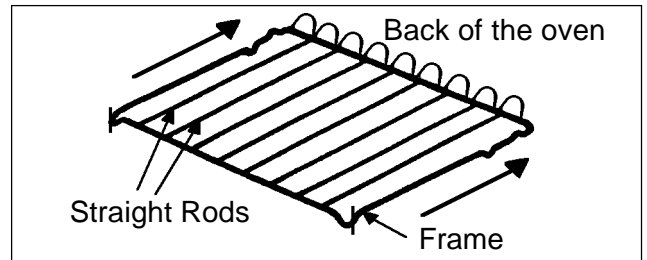

i HINTS AND TIPS

- There are zones of heat within the oven. The temperature in the middle is the gas mark you have chosen. The top of the oven is slightly hotter and the lower shelf slightly cooler.
- The base of the oven can be used to warm plates.

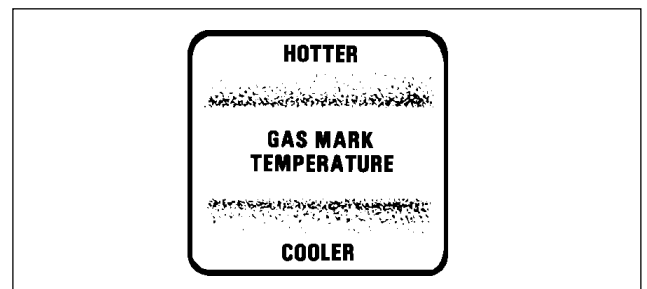

- Use the heat zones when cooking foods requiring different temperatures all at the same time.

- When cooking more than one tray of similar items, for example cakes or biscuits, swap the trays round during cooking. Alternatively remove the top tray when the food is cooked and move the lower tray to the higher shelf to finish cooking.

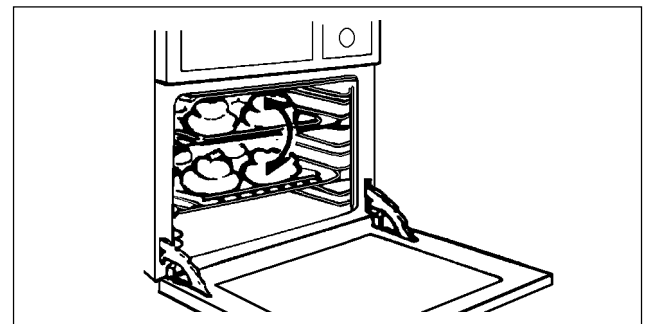

- It is recommended that when baking larger quantities, the shelf positions should be evenly spaced to suit the load being cooked. A slight increase in cooking time may be necessary.

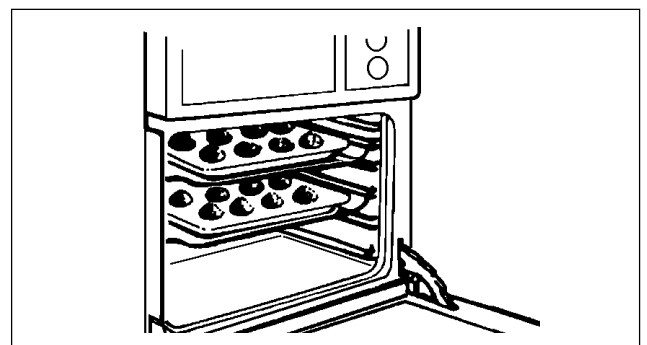

- The material and finish of the baking tray and dishes will affect the degree of base browning of the food. Enamelware, dark, heavy or non-stick utensils increase base browning. Shiny aluminium or polished steel trays reflect the heat away and give less base browning.

- For economy leave the door open for the shortest possible time, particularly when placing food into a pre-heated oven.

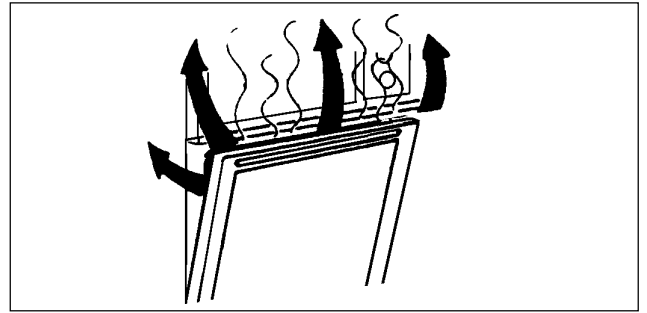

- When roasting we recommend that you use the trivet in the meat tin. Fat and meat juices will drain into the meat tin below and can be used to make gravy. The trivet also prevents splashes of fat from soiling the oven interior.

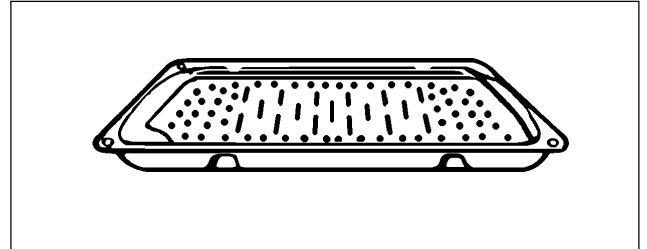

Note. The meat tin should not be placed on a heated hotplate as this may cause the enamel to crack.

MAIN OVEN COOKING CHART

The Gas mark settings are intended as a guide only. It may be necessary to increase or decrease the settings to suit individual preferences and requirements.

Note: Shelf positions are counted from the top of the oven downwards.

FOOD	SHELF POSITION	GAS MARK SETTING
Viennese Biscuits	7	7
Bread	10	7
Bread Rolls / Buns	10	7
Cakes: Small & Queen	5 & 11	5
Sponges	5 & 11	5
Victoria Sandwich	5 & 11	4
Madeira	7	4
Rich Fruit	9	2
Christmas	10	2
Gingerbread	8	2
Meringues	14	1 - 2
Flapjack	7	5
Shortbread	7	2
Baked Custard	10	3
Casseroles : Beef / Lamb	10	3
Chicken	10	4
Convenience Foods	7	According to Manufacturers Instructions
Fish	7	5
Fish Pie - potato topped	8	7
Fruit Pies	4 & 10	6
Crumbles	6	5
Milk Puddings	10	2
Pasta / Lasagne etc.	7	5
Pastry : Choux - Eclairs/profiteroles	5	4
Flaky / Puff pies	7	7
Shortcrust -	7	6
Mince pies	4	5
Meat pies	5 & 11	6
Quiche, Tarts, Flans	7	5
Roast Meat / Poultry	9	5
Turkey	14	5
Scones	5 & 11	7
Shepherds Pie	8	7
Soufflés	7	5
Vegetables : Baked Jacket Potatoes	7	5
Roast Potatoes	10	6
Yorkshire Puddings - large	5	7
- individual	5	7

SLOWCOOK FEATURE

USES OF SLOWCOOK

Slowcooking in the main oven allows most foods to be cooked at a low temperature over a number of hours. A variety of foods, particularly cheaper cuts of meat can be cooked in this way making them tender, tasty and succulent.

This feature is most convenient when used in conjunction with the automatic timer as there is no need to be present at the start of cooking.

HOW TO USE SLOWCOOK

1. Open the main oven door.
2. Push in the main oven control and turn it to gas mark 9. When the burner has lit there will only be small flames at first.
3. Turn the control to the Slowcook setting. 
4. Wait until the burner has a large flame.
5. Close the oven door.

THINGS TO NOTE

- The oven light will come on when the oven control is turned.
- The cooling fan for the controls may operate after a time. See page 7 for further details on the operation of the cooling fan.
- If an automatic programme has been set, the oven light does not come on until the cook time begins.



Do not place cookware over the oven burner. This will damage the oven and ovenware.



HINTS AND TIPS

- Always cover food with a close fitting lid or tin foil.
- Do not re-heat food using the slow cook function.
- Slow cooked food should be eaten as soon as possible after cooking. It is not advisable to allow food to cool down slowly.
- It is recommended that vegetable dishes, sponge and suet puddings are prepared just prior to cooking.
- A complete meal can be cooked using slow cook function.
- Most foods should be cooked on the middle shelf. Use shelf position 9 for large joints and stews. Ensure dishes are evenly spaced to allow for maximum circulation around food.
- Thicken casseroles by tossing meat in flour first or by blending flour with water and adding at the end.
- Pastries, breads and biscuits are not suitable for slow cooking.
- Adjust seasoning at the end of the cook time.
- Thaw frozen foods thoroughly before cooking.

MAIN OVEN

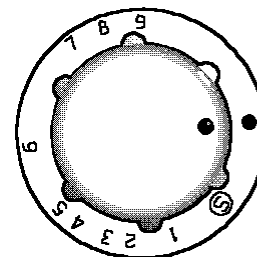

MAIN OVEN

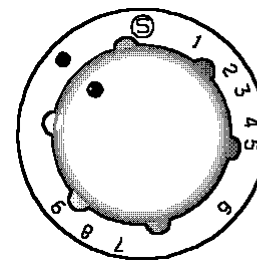

MEAT, FISH AND POULTRY

- Prime cuts of meat for roasting are better not slow cooked as flavours are retained to their fullest when roasting.
- Do not Slowcook joints of meat over 6lb (2.7kg) in weight.
- Only Slowcook joints of pork if you can make sure by using a meat thermometer that the temperature inside the joint is at least 88°C.
- Do not Slowcook poultry over 4lb 8oz (2kg) in weight.
- Cook stuffing separately.
- Do not Slowcook more than one 2lb (1kg) meat stew in the oven at the same time when slow cooking. Thicken after cooking with a little cornflour and water if desired.
- All frozen meat/poultry should be thoroughly thawed before preparing for slow cooking.

- **Cooking times**

Small items e.g. chops 3 - 4 hours

Small joints, stews 6 - 8 hours

Large joints 7 - 9 hours

Fish 2 - 3 hours

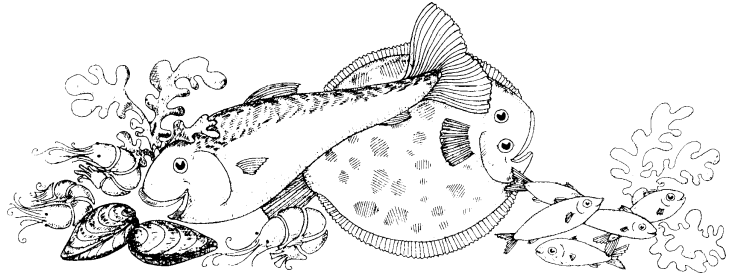

VEGETABLES

- Cut vegetables into thin slices or small cubes as they can take a long time to cook.
- To prevent potatoes discolouring, cook immediately after preparation and add a few drops of lemon juice.
- When cooking vegetables in a casserole, place them under the meat to keep them immersed in the gravy/sauce.
- Cook for up to 6 hours.



MILK AND MILK PRODUCTS

- Cream may curdle and separate during a long cook time. Add cream at the end e.g. to a soup, just before serving.
- Place a baked custard in a bain-marie or water bath and cover the tin with foil.
- Cook for 2 - 4 hours

PASTA AND RICE

- Cook pasta on the hob and add to the dish at the end of the cook time.
- Rice should be the 'easy cook' type. Use 250ml (½ pint) stock to 100g (4oz) rice.
- Cooking time up to 6 hours.

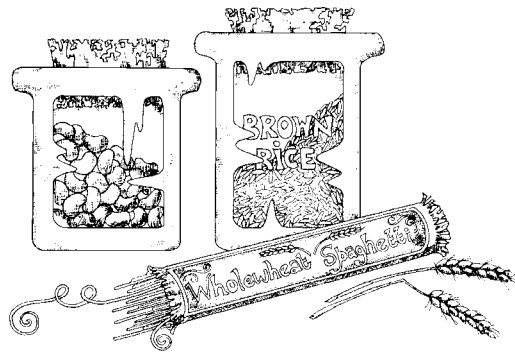

DRIED BEANS AND FRUIT

- Soak overnight prior to cooking.
- **DRIED RED KIDNEY BEANS AND ALL OTHER VARIETIES OF BEANS SHOULD BE RINSED, COVERED WITH FRESH WATER IN A SAUCEPAN ON THE HOB AND BROUGHT TO THE BOIL FOR AT LEAST 10 MINUTES BEFORE DRAINING AND ADDING TO THE DISH.**
- Canned beans may be placed in the dish with other raw ingredients as they have already been cooked.

PRESERVES

- Only the softening of fruit can be carried out using slow cook. The jam or marmalade must be boiled up on the hob.
- Chutney may thicken sufficiently after slow cooking if left to stand or may require boiling on the hob.

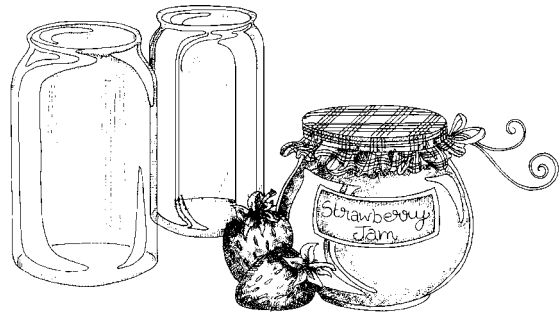

CARE AND CLEANING



For hygiene and safety reasons this gas cooker must be kept clean.

A build up of fat or other foodstuffs could cause a fire.

Before cleaning the cooker always allow the cooling fan for the controls to cool the cooker down before switching off the electricity supply.

CLEANING MATERIALS

Before using any cleaning materials on your cooker, check that they are suitable and that their use is recommended by the manufacturer.

Cleaners that contain bleach should NOT be used as they may dull the surface finishes. Harsh abrasives should also be avoided.

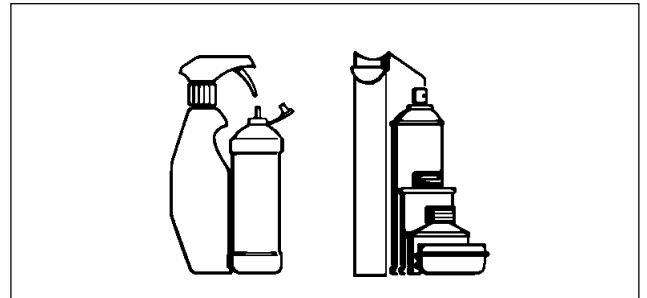

CLEANING THE OUTSIDE OF THE COOKER

DO NOT use abrasive cleaning materials or scourers on the outside of the cooker as some of the finishes are painted and damage may occur. Regularly wipe over the control panel and oven doors using a soft cloth well wrung out in warm water to which a little washing up liquid has been added.

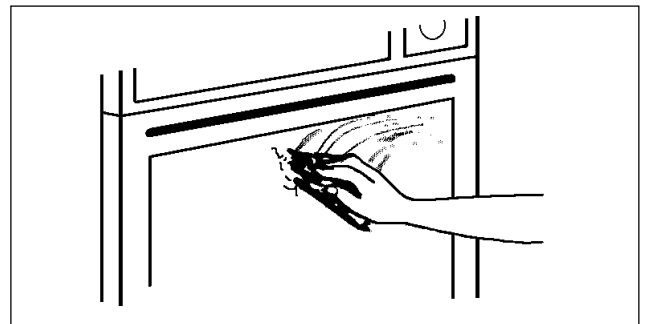

Do not attempt to remove any of the control knobs from the panel as this may cause damage.

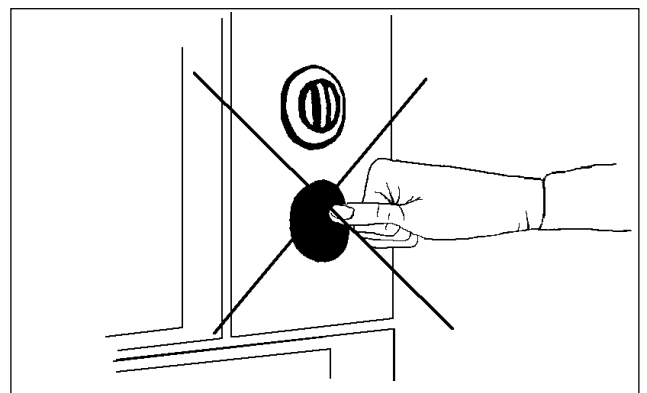

CLEANING THE OUTER AND INNER DOOR GLASS PANELS



To prevent damaging or weakening the door glass panels avoid the use of the following:

- Household detergents and bleaches
- Impregnated pads unsuitable for non-stick saucepans
- Brillo/Ajax pads or steel wool pads
- Chemical oven pads or aerosols
- Rust removers
- Bath/Sink stain removers

The outer oven door glass panels are removable for cleaning.

TO REMOVE THE OUTER GLASS

1. Open the oven door slightly to gain access to the two cross head screws on the top of the oven door.
2. Loosen the two screws using a Pozidrive screwdriver.
3. Holding the door glass securely in place with one hand remove the screws and washers with the other hand.

The screws and washers retain the trim on the top of the grill door. Note the position of the trim on the door.

4. Holding the door and glass with one hand, gently pull towards you and slightly lift the door glass with the other hand to disengage the panel from the location point at the bottom of the door. Gently release the door to close it.

5. Clean the outer and inner glass using hot soapy water or Hobbrite. Should the inner face of the outer door glass be heavily soiled it is recommended that soapy water with a high concentration of soap is used. To prevent streaking a glass cleaning spray may be applied and the glass polished with a soft cloth. Ensure that all parts are well rinsed and thoroughly dry before attempting to replace the outer door glass.



If the door glass panel becomes chipped or has deep scratches the glass will be weakened and must be replaced to prevent the possibility of the panel shattering. Please contact your local Service Centre who will be pleased to advise further.

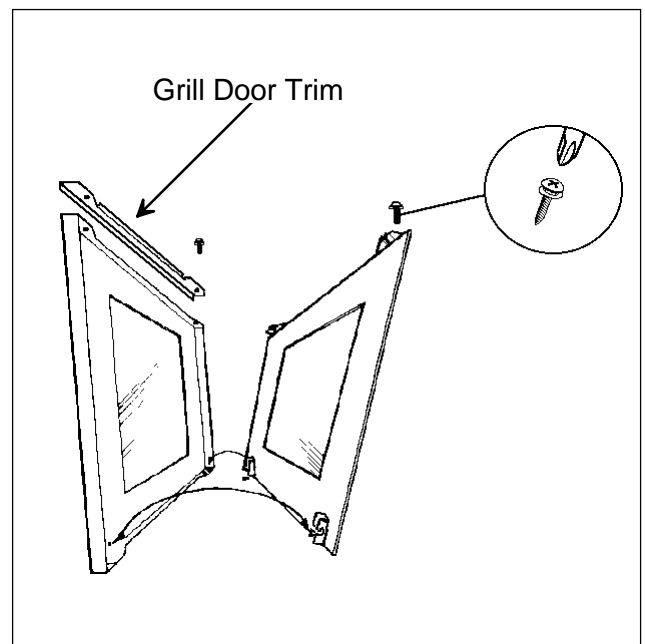

TO REPLACE THE OUTER DOOR GLASS

1. Holding the door glass panel with both hands, gently place the locators into the holes of the brackets at the bottom of the oven door.
2. Holding the door glass with your left hand, use your right hand to open the oven door. Bring the door gently towards the glass panel ensuring the screw location holes line up.
3. Place the trim in the correct position on the top of the grill door.
4. Hold the glass in place with one hand and insert the cross head screws with washers into the location holes with the other hand. Give the screws one turn to ensure the glass is secure.
5. Tighten the screws positively with a Pozidrive screwdriver before closing the oven door.



DO NOT attempt to use the oven without the glass being in place.

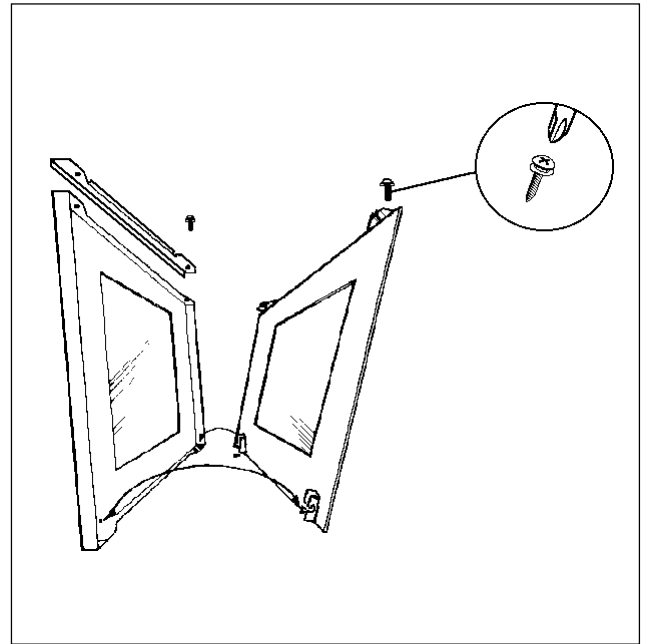

TO CLEAN THE INNER GLASS DOOR

The inner glass door is not removable. Clean using hot soapy water or Hobbrite and a soft cloth. **DO NOT** use abrasives as they may damage the glass or seal.

CLEANING THE MAIN OVEN

The main oven top and sides are coated with a Stayclean finish. The back panel is vitreous enamelled.

The Stayclean areas in the main oven should not be cleaned manually. See Care of Stayclean Surfaces on page 33.

The main oven base and back panel can be cleaned using normal oven cleaners or aerosol oven cleaners with care. Ensure that the manufacturers instructions are followed and protect the oven burner with aluminium foil to prevent it from becoming blocked. Do not spray aerosol cleaners through the aperture in the back panel as the cavity behind is coated with a Stayclean finish.

Take care when cleaning round the back panel aperture.

Do not use any cleaning agents or scrapers on the oven roof, back panel sides and door seal.

Damage will occur if soap impregnated steel wool pads, aerosol cleaners or any abrasive cleaners are used.

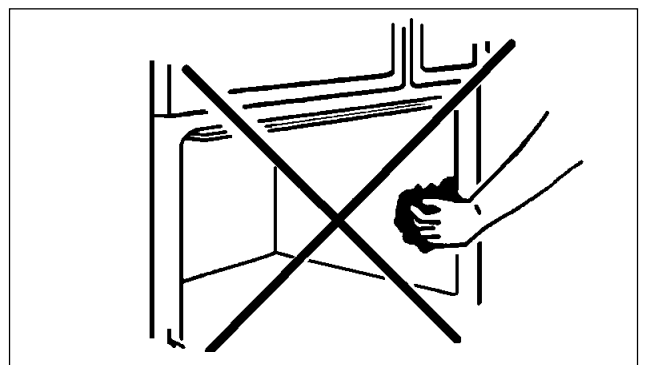

CLEANING THE GRILL / TOP OVEN COMPARTMENT

The grill / top oven compartment base, sides and back panel can be cleaned using oven cleaners or aerosol oven cleaners with care. Ensure that the manufacturers instructions are followed and that all parts are well rinsed afterwards. Aerosol cleaners must not come into contact with the grill or oven burners as this may cause damage.

Protect the burners with aluminium foil to prevent them becoming blocked. Do not spray aerosol cleaners through the aperture in the back panel. Take care when cleaning around the back panel aperture.

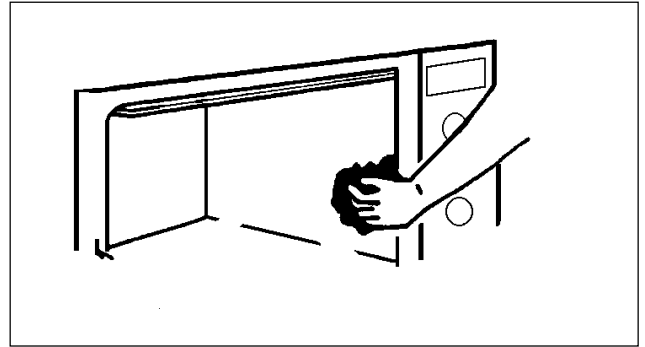

TO REMOVE THE WIREWORK RUNNERS

The wirework runners in both ovens can be removed for cleaning.

1. Remove all shelves and furniture from the oven.
2. Hold the wirework at the bottom and gently pull towards the centre of the oven.
3. Unhook the runner at the top and remove it from the cavity.
4. To replace, hook the wirework back into the oven sides.

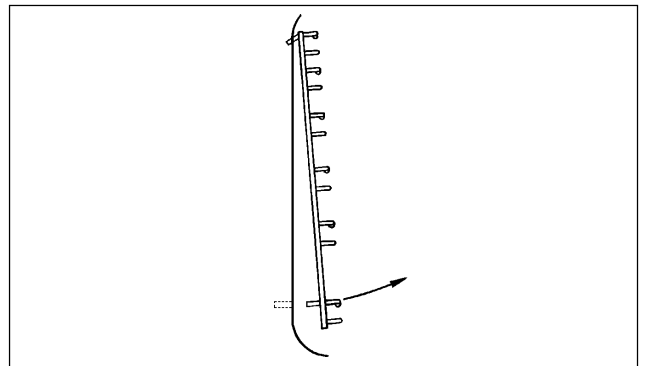

Ensure that the wirework runners are firmly in place before refitting the oven shelves.

CLEANING THE SHELVES, WIREWORK RUNNERS AND OVEN FURNITURE

Soak the oven shelves, wirework runners and grilling grid in hot soapy water if heavily soiled, they will then clean more easily. If the shelves are heavily soiled a soap impregnated steel wool pad can be used.

The grill pan, meat tin and trivet can be cleaned using a soap impregnated steel wool pad.

All items of grill and oven furniture are dishwasher safe with the exception of the grill pan handle.

CARE OF STAYCLEAN SURFACES

The main oven top and sides are coated with a Stayclean finish. They should not be cleaned manually.

During normal use the Stayclean coating will become splashed with fats and food residues. When the Oven Cleaning Cycle is selected, the Stayclean surfaces burn off any soilage. Regular use of the Oven Cleaning Cycle function will help to keep the panels in good condition.

THE OVEN CLEANING CYCLE- MAIN OVEN ONLY

1. Remove oven shelves, wirework runners and bakeware from oven.
2. Push in and turn the main oven control to mark 5 for 30 minutes.
3. Turn the temperature up to mark 7 for 2 hours or until the oven is presentably clean. Some staining will remain.

THINGS TO NOTE

- The cooling fan for the controls will operate after a short time when the oven cleaning cycle is selected. It may run on after the controls are switched off until the cooker has cooled. See page 7 for more details on the operation of the cooling fan.

HINTS AND TIPS

- Slight discolouration and polishing of the Stayclean surfaces may occur in time, but this will not affect their self cleaning properties.
- A good time to use the oven cleaning cycle is after the weekly roast.
If you do a lot of roasting and very little baking you should follow the cleaning cycle every week. If you roast very little you will only need to follow the cleaning cycle every 2 - 3 weeks.
- Follow the recommendations below to keep soilage to a minimum.

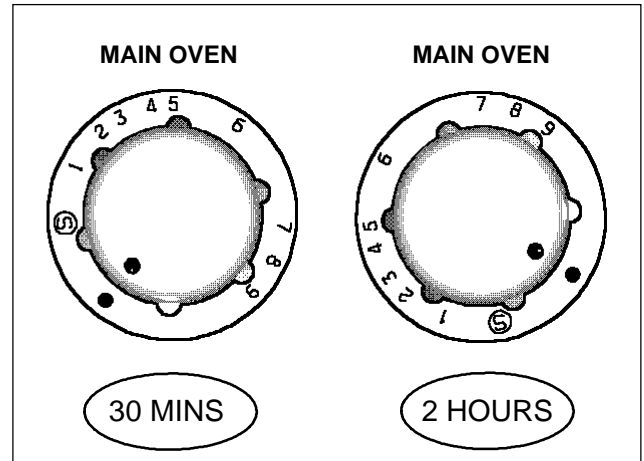
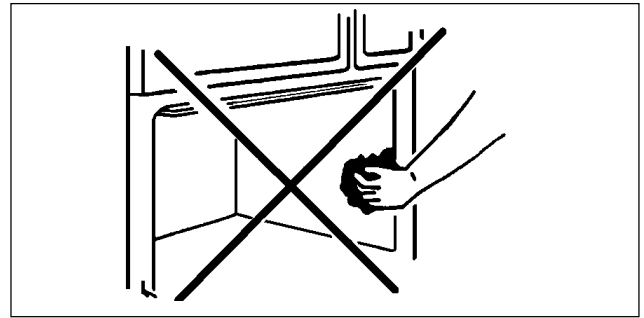

COOKING TO REDUCE SOILAGE

- Cook at the recommended temperatures. Higher temperatures during roasting will increase soilage. Try cooking at lower temperatures for an increased length of time, you will save energy and often the joint is more tender.
- Use minimal, if any, extra oil or fat when roasting meat, potatoes only require brushing with fat before cooking. Extra fat in the oven during roasting will increase splashing and soilage.
- It is not necessary to add water to the meat tin when roasting. The water and the fat juices from the joint create excessive splattering during cooking, even at normal temperatures, as well as causing condensation.
- Covering joints during cooking will also prevent splashing onto the interior surfaces. Removing the covering for the last 20-30 minutes will allow extra browning if required. Some large joints and turkeys especially benefit by this method of cooking, allowing the joint to cook through before the outside is overbrowned.
- **Do use** the trivet in the roasting tin. During roasting the fat from the joint will be contained beneath the trivet and therefore prevent it from splattering onto the Stayclean finish.

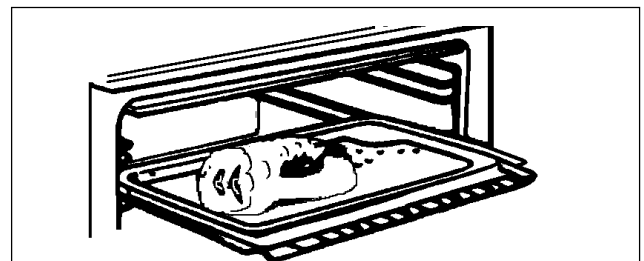
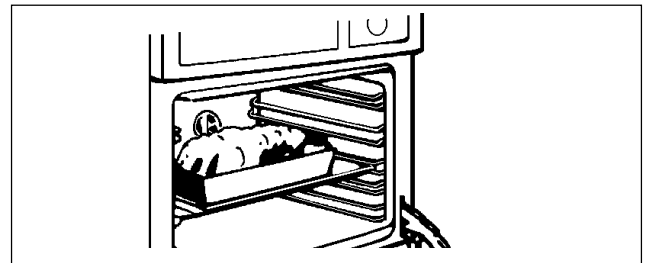
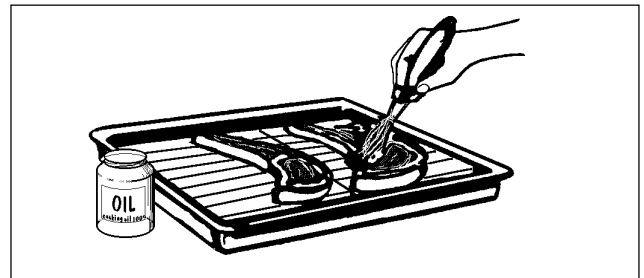

REPLACING AN OVEN LIGHT BULB



Isolate the cooker from the electricity supply before replacing the bulb.

The type of bulb required is a 300°C, 25 watt small Edison Screw.

1. Make sure the cooker is cool before you replace a bulb.
2. Open the oven door and remove the shelves and wirework runners.
Instructions on how to remove the wirework runners are given on page 32.
3. Pull the glass bulb cover towards you and then pull it off. If necessary use a screwdriver to carefully lever off the cover, taking care not to damage the oven cavity.
4. Unscrew the bulb by turning it to the left.
5. Fit a new bulb and then replace the glass bulb cover.
6. Refit the wirework runners and replace the oven shelves.
7. Restore the cooker to the electricity supply and reset the time of day.

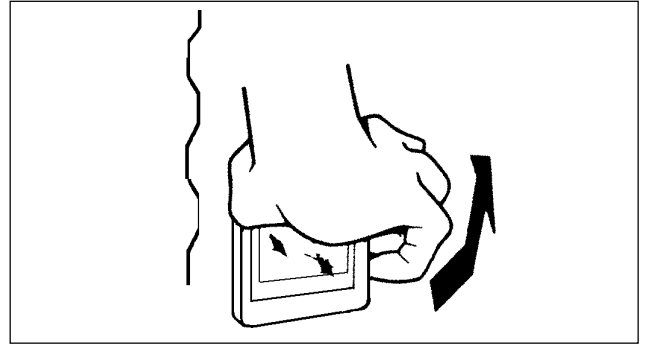

IF SOMETHING DOESN'T WORK

Please carry out the following checks on your cooker before calling a Service Engineer. It may be that the problem is a simple one which you can solve yourself without the expense of a service call.

If our Service Engineer finds that the problem is listed below you will be charged for the call whether or not the cooker is under guarantee.

PROBLEM	POSSIBLE SOLUTION
The grill, ovens and timer do not work	<p>Check that the cooker is switched on at the wall.</p> <p>Check that there has not been a power failure. If the electricity supply has been interrupted or you have switched the oven off at the wall, the grill may have cut out before the cooling fan has cooled the oven down. Switch the oven on at the wall until the cooling fan has cooled it down.</p> <p>Check that there is not a problem with your gas supply. You can do this by making sure that other gas appliances such as your central heating or gas fire are working.</p>
The Grill and Top Oven work but the Main Oven does not	<p>Check that the timer is set for manual operation. See page 11.</p>
The Grill sparks in use	<p>Ensure that the grill door is open when grilling. If the grill door is closed whilst the burner is lit it will automatically re-light when the door is opened.</p> <p>Always light the burner before placing the grill pan and food under the grill.</p>
The Grill does not work	<p>Ensure the cooling fan is running when the grill is on. If the cooling fan fails, the grill will not work.</p> <p>Contact your nearest Service Centre.</p>
The timer does not work	<p>Check that the instructions for the operation of the timer are being closely followed.</p>
The oven or grill burner flame is unstable / noisy	<p>Check that the burner flames stabilise after a few minutes. The cooker may need to adjust to room temperature.</p>

The oven is not cooking evenly

Check that the cooker is correctly installed and is level.

Check that the recommended Gas mark settings and shelf positions are being used.

If you use a tin or tray larger than the recommended size be prepared to turn it round during cooking. If cooking a large item be prepared to turn it round during cooking.

The oven light fails to illuminate

The oven light bulb may need replacing see page 35.

If the Main Oven is set for automatic cooking the light will illuminate when the cook time begins.

Food is cooking too quickly or too slowly

Check that the recommended Gas mark settings and shelf positions are being used. See page 25. Be prepared to adjust the gas mark up or down by one setting to achieve the results you want.

PEACE OF MIND FOR 24 MONTHS

Standard guarantee conditions

We, Zanussi Limited, undertake that if within 24 months of the date of the purchase this Zanussi appliance or any part thereof is proved to be defective by reason only of faulty workmanship or materials, we will, at our option repair or replace the same FREE OF CHARGE for labour, materials or carriage on condition that:

- The appliance has been correctly installed and used only on the electricity supply stated on the rating plate
- The appliance has been used for normal domestic purposes only, and in accordance with the manufacturer's instructions
- The appliance has not been serviced, maintained repaired, taken apart or tampered with by any person not authorised by us
- All service work under this guarantee must be undertaken by a Zanussi Service Force Centre.
- Any appliance or defective part replaced shall become the Company's property
- This guarantee is in addition to your statutory and other legal rights

Home visits are made between **8.30am** and **5.30pm** Monday to Friday. Visits may be available outside these hours in which case a **premium** will be charged.

Exclusions

This guarantee does not cover:

- Damage or calls resulting from transportation, improper use or neglect, the replacement of any light bulbs or removable parts of glass or plastic
- Costs incurred for calls to put right an appliance which is improperly installed or calls to appliances outside the United Kingdom
- Appliances found to be in use within a commercial environment, plus those which are subject to rental agreements
- Products of Zanussi manufacture which are not marketed by Zanussi Limited

European Guarantee

If you should move to another country within Europe then your guarantee moves with you to your new home subject to the following qualifications:

- The guarantee starts from the date you first purchased your product
- The guarantee is for the same period and to the same extent for labour and parts as exists in the new country of use for this brand or range of products
- This guarantee relates to you and cannot be transferred to another user
- Your new home is within the European Community (EC) or European Free Trade Area
- The product is installed and used in accordance with our instructions and is only used domestically, i.e. a normal household
- The product is installed taking into account regulations in your new country

Before you move please contact your nearest Customer Care centre, listed below, to give them details of your new home. They will then ensure that the local Service Organisation is aware of your move and able to look after you and your appliances.

France	Senlis	+33 (0)3 44 62 29 99
Germany	Nürnberg	+49 (0)911 323 2600
Italy	Pordenone	+39 (0)1678 47053
Sweden	Stockholm	+46 (0)8 738 79 50
UK	Newbury	+44 (0)1635 521

SERVICE AND SPARE PARTS

HELP US TO HELP YOU

Please determine your type of enquiry before writing or telephoning.

SERVICE

Before calling out an Engineer, please ensure that you have read the details under the heading 'If Something Doesn't Work', on pages 36 and 37, and have the model number and purchase date to hand. You can contact your local Service Centre by telephoning:

0990 929929

More information regarding Service can be found in the Customer Care Booklet supplied with the Cooker.

Please note that all enquiries concerning service and the purchase of spare parts should be addressed to your local Zanussi Service Force Centre.

CUSTOMER CARE DEPARTMENT

For general enquiries concerning your Zanussi cooker or further information on Zanussi products, you are invited to contact our Customer Care Department by letter or telephone as follows:

Customer Care Department
Zanussi Limited
Zanussi House
Hambridge Road
Newbury
Berkshire
RG14 5EP

Tel: (01635) 521313

THE GAS CONSUMERS' COUNCIL

The Gas Consumers' Council (GCC) is an independent organisation which protects the interests of Gas users. If you need advice, you will find the telephone number in your local telephone directory under Gas.

TECHNICAL DETAILS

Loading Info:

Grill Burner	Natural Gas	L.P. Gas
Heat Input	2.8kW (9554 Btu/h)	2.8kW 201 g/h
Injector Marking	123	089
Top Oven*		
Heat Input	1.7kW (5800 Btu/h)	1.7kW 122 g/h
Injector Marking	095	
Flame Supervision Device	Diamond 'H' GSD 100/48	Diamond 'H' GSD 100/49
Thermostat	Sourdillon 63105/982	Sourdillon
Thermostat By-Pass Marking	Fixed Internal	Fixed Internal
Main Oven		
Heat Input	1.7kW (5800 Btu/h)	1.7kW 122 g/h
Injector Marking	095	
Flame Supervision Device	Diamond 'H' GSD 100/28	Diamond 'H' GSD 100/30
Thermostat	Diamond 'H' 1100 -122/B2	Diamond 'H' 1100 -123/B2
Thermostat By-Pass Marking	74	79
Oven Light:	0.05kW	
Control Cooling Fan	0.020kW	
Timer:	0.005kW	
Height:	Appliance 760 mm	Installed 720 mm
Width:	593 mm	
Depth:	535 mm	
(excluding handles and knobs)		
Weight:	49kg	
Connection:	Rear top right hand side of	
Gas	appliance Rc $\frac{1}{2}$ ($\frac{1}{2}$ " B.S.P. Female)	
Electric	230/240 Volt A.C. 50Hz Mains 3 core cable and moulded plug fused to 3 amps.	

* Cannot be used at the same time as the grill burner

IMPORTANT - SAFETY REQUIREMENTS

This appliance must be installed in accordance with the Gas Safety (Installation and Use) Regulations Current Editions. Detailed recommendations are contained in the following British Standard Codes of Practice - BS.6172, BS.5440: Part 2 and BS.6891. All British Standards must be 'Current Editions'.

PROVISION FOR VENTILATION

This appliance is not connected to a combustion products evacuation device. It shall be installed and connected in accordance with the current installation regulations. Particular attention shall be given to the relevant requirements regarding ventilation.

The room containing the appliance should have an air supply in accordance with BS. 5440: Part 2 Current Edition. All rooms require an openable window or equivalent and some rooms will require a permanent vent as well. For room volumes up to 5m³ an air vent of 100cm² is required: for room volumes between 5m³ and 10m³ an air vent of 50cm² is required. If the room has a door that opens directly to the outside, no air vent is required. For room volumes that exceed 11m³ no air vent is required. If there are other fuel burning appliances in the same room, BS.5440: Part 2 Current Edition should be consulted to determine the requisite air vent requirements.

Prolonged intensive use of the appliance may call for additional ventilation, for example opening a window, or more effective ventilation, for example increasing the level of mechanical ventilation where present.

INSTALLATION INSTRUCTIONS

THINGS YOU NEED TO KNOW



WARNINGS:

- In the interest of safety this appliance must be installed and / or serviced by a competent person (Corgi registered). Safety may be impaired if installation is not carried out in accordance with these instructions.
- This cooker must be earthed.
- Do not remove the screws from the earth tab extending from the oven mains terminal block (Fig. 1).
- Before connecting the cooker make sure that the gas type and the voltage of your electricity supply is the same as that indicated on the rating plate. The rating plate can be seen by opening the grill /top oven door and looking below the oven door seal.
- Do not alter the electrical circuitry of this cooker.

NOTE: HOUSE CIRCUIT

Earth leakage / continuity tests must be carried out before the cooker is connected to the mains supply and re-checked after fitting.

NOTE: It is good practice to:

- Fit an Earth Leakage Circuit Breaker to your house wiring.
- Wire your appliance to the latest IEE regulations.

THINGS TO NOTE

LOCATION OF APPLIANCE

The appliance may be located in a kitchen, a kitchen/diner or bedsitting room, but not located in a bathroom or shower room.

L.P.G. cookers **MUST NOT** be installed below ground level i.e. in a basement.

It is essential that there is a minimum clearance of 2mm between the top surface of the appliance and the inside top of the cabinet.

- This cooker is designed to be fitted between cabinets with the recommended dimensions as shown in Figs. 2 and 3.

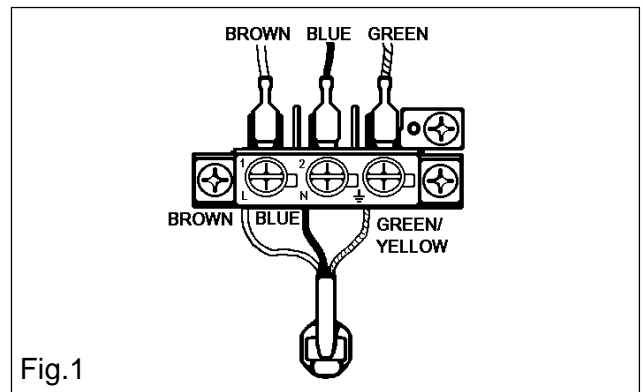

Fig.1

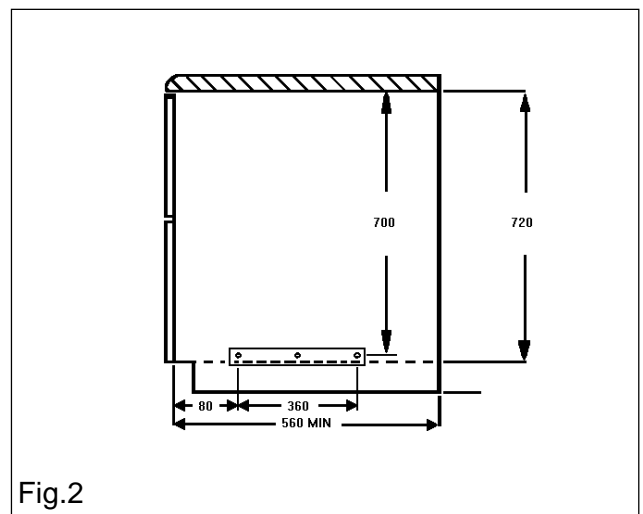

Fig.2

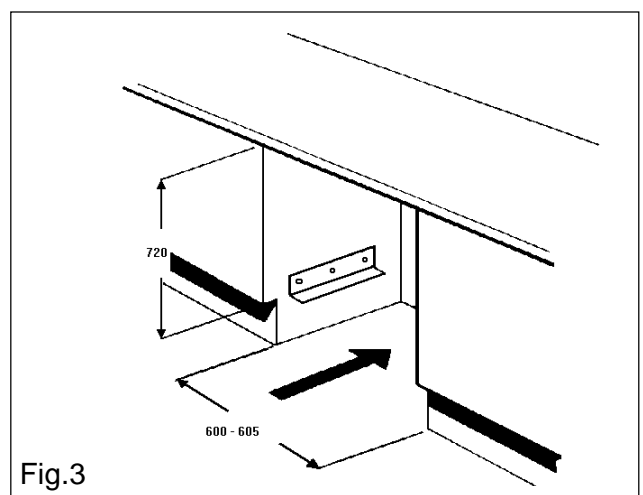

Fig.3

INSTALLATION INSTRUCTIONS

- This appliance must not be installed on a wooden base.
- The dimensions given provide adequate air circulation around the unit within the cabinet, ensuring compliance with BS EN60-335.
- Enquiries regarding the installation of the cooker point if required should be made to your Regional Electricity Company to ensure compliance with their regulations.

GETTING THINGS READY

PREPARING CABINET FOR FITTING OVEN

- Make sure the cabinet is the correct size for the appliance to be fitted (Ref. Fig. 4).
- If the size is between 605-610*mm, then the cabinet should be modified so that at the screw fixing points the recommended dimension of at least 600-605mm is maintained. The modification should ideally be localised to ensure that after screw fitment the oven is **securely** fixed into position.
- The adjacent cabinets must be stable and firmly secured to the wall or floor. If necessary, make arrangements to ensure the work surface below which the oven will rest is level.
- Mark the centre of the aperture into which the appliance is to be fitted onto the plinth board.
- Remove the plinth board from in front of the cabinets.
- Cut the required ventilation slot in the plinth as detailed in Fig.5.
- Drill two pilot screw holes into the sides of the adjacent cabinets, in the positions indicated by Fig. 4.
- Fit the appliance mounting brackets using the two holes indicated in Fig. 6 to the adjacent cabinets (Ref. Fig.4 & 7)
- Check that the mounting brackets are level. They can be adjusted if necessary by using the extra holes at the ends of the brackets. Once the brackets are level, drill a pilot hole through the central hole in the bracket and fit the remaining screw.

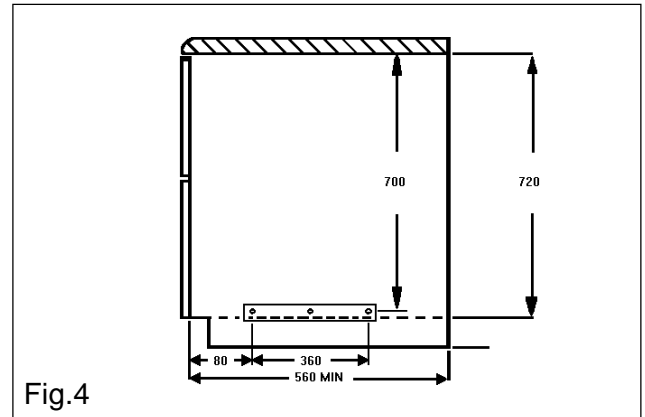

Fig.4

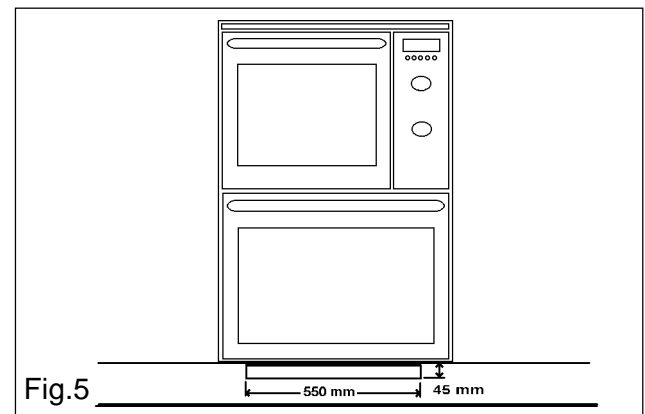

Fig.5

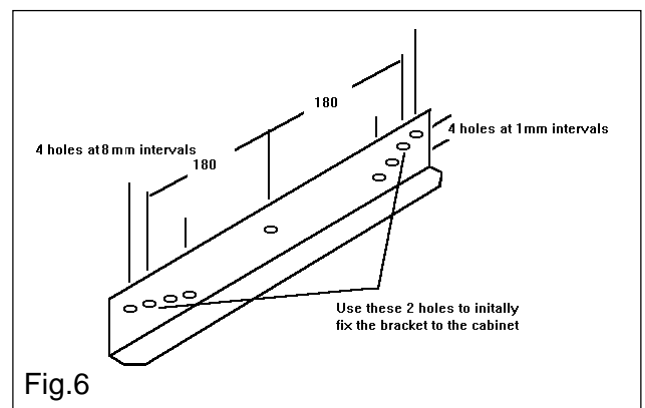

Fig.6

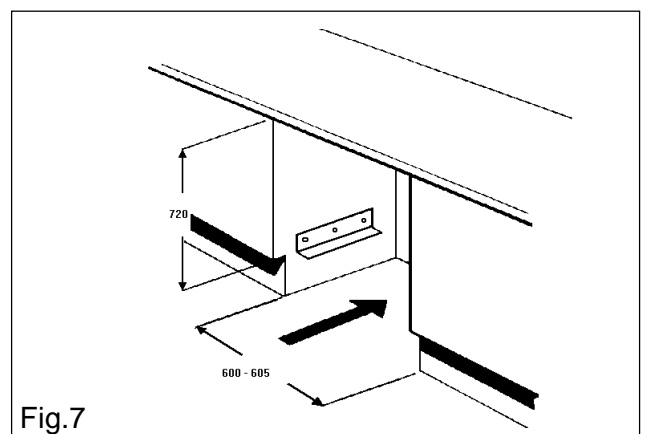

Fig.7

INSTALLATION INSTRUCTIONS

FLEXIBLE PIPE INSTALLATION

FITTING THE APPLIANCE AND CABINET

It is recommended that a $\frac{3}{8}$ " 1100mm long angled flexible hose (BFS), and a $\frac{1}{2}$ " straight socket (BFS) be used for the installation. However, any approved hose of the right length can be used.

IMPORTANT: Flexible tubing used must comply with BS 669 current editions. L.P.G. flexible connections must be of a type suitable for L.P.G. and capable of operation up to 50mbar and carry a red stripe, band or label.

NOTE: Only liquid sealants can be used in threaded gas connections. Do not use P.T.F.E. tape.

- 1 Make suitable arrangements for gas and electric supplies into the installation site.
- 2 When unpacking the appliance keep it on its polystyrene base until it is put into the cabinet to avoid damage.
- 3 If the gas supply bayonet and wall fixing bracket are to be located behind the appliance it must be located in the shaded area as indicated in Fig.8.
- 4 Connect flexible hose to the gas inlet supply block see Fig.8. The hose should be long enough to allow the appliance to be withdrawn from the cabinet.
- 5 Position the appliance in front of the cabinet and run the supply cable (See Connection to Electricity Supply) through the cabinet and connect to the junction box or socket. Ensure that the supply is isolated at this stage. Connect flexible hose to the bayonet connector.

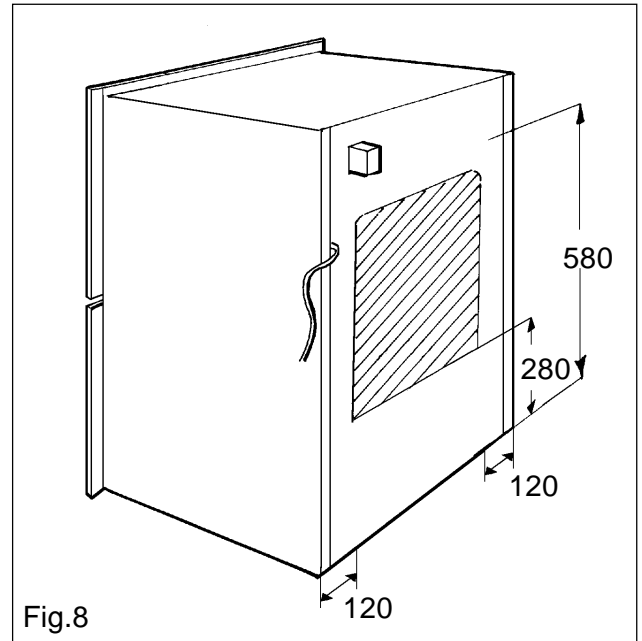

INSTALLATION INSTRUCTIONS

CONNECTION TO ELECTRICITY SUPPLY



WARNING: This appliance must be earthed, do not earth this appliance to the gas supply piping.

This appliance must be connected to a isolated 220V-240V a.c. 50Hz supply which incorporates a 3 ampere fuse. If any other type of plug is used it should incorporate a 5 ampere fuse in either the plug or adapter or at the distribution board. The appliance is supplied with 2 metres (6.5 ft) of 5 ampere 3 core cable fitted with a moulded plug. If this proves insufficient to allow the appliance to be plugged into the nearest supply socket, the supply cable can be either extended by using a B.E.A.B. approved 3-way sealed flex connector with integral flex clamps.

DO NOT EXTEND THE CABLE USING PLASTIC OR CERAMIC CONNECTION TERMINAL BLOCKS AND/OR INSULATION TAPE.

Should the supplied cable be required to be threaded through small apertures in the cabinets it can be removed from the mains plug.

If the supplied moulded plug is cut off dispose of it safely as it will be a shock hazard if inserted into a 13 amp socket elsewhere in the house.

To fit a 3 pin 13 amp plug to the end of the appliance cable (Fig.9). Connect the wires as follows:

BROWN to the live terminal.
BLUE to the neutral terminal.
GREEN / YELLOW to the earth terminal.

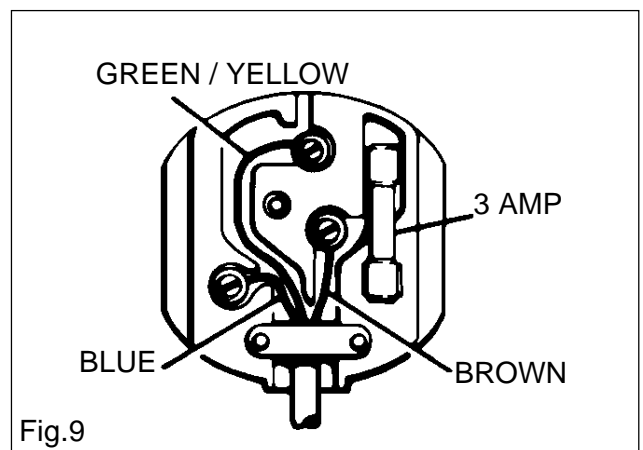

Fig.9

INSTALLATION INSTRUCTIONS

As the colours of the wires in the mains lead of this appliance may not correspond with the coloured markings identifying the terminals in your plug, proceed as follows:

The wire which is GREEN and YELLOW must be connected to the terminal in the plug which is marked with the letter 'E' or by the earth symbol \perp or coloured GREEN or GREEN and YELLOW.

The wire which is coloured BLUE must be connected to the terminal which is marked with the letter 'N' or coloured black.

The wire which is coloured BROWN must be connected to the terminal which is marked with the letter 'L' or coloured RED.

FIT A 3 AMP FUSE TO THE PLUG FUSE HOLDER

- Turn on Gas and Electric supplies
- Carry out a soundness test.
- Switch off electric supply.

INSTALLATION BETWEEN CABINETS

- Lift the appliance into the cabinet making sure the hose and cable are not trapped. Push the appliance as far back as it will go.
- Centralise and fix the appliance to the underside of the worktop using the two stability screws provided, in the position indicated in Fig.10.
- Refit the plinth board.

Place the top trim with the cork washers uppermost flush with the edge of the worksurface (see Fig.11) and screw into position using the screws supplied with the cooker.

Switch on the cooker then refer to the operating instructions in the following pages.

- Carry out gas soundness check.
- Ensure the owner is given these operating instructions.

CHECKING ELECTRICAL CONNECTIONS

- Confirm the cooker is correctly connected by switching on and observing the various oven functions .
- The electronic timer will flash on and off.

NOTE: HOUSE CIRCUIT

Earth leakage / continuity tests must be carried out before the cooker is connected to the mains supply and re-checked after fitting.

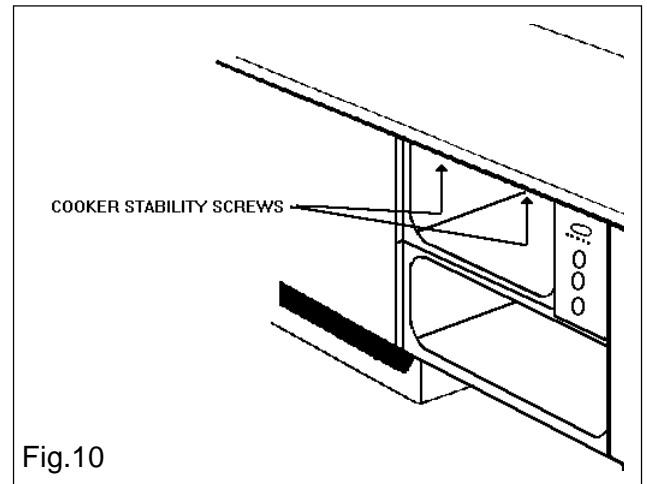

Fig.10

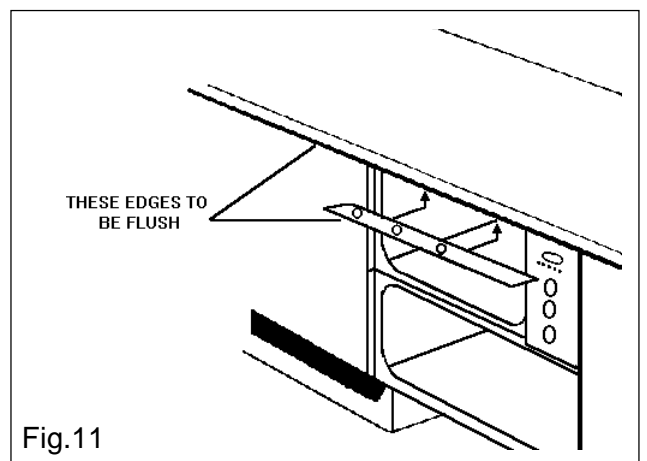

Fig.11

INSTALLATION INSTRUCTIONS

PRESSURE TESTING

To pressure test connect the pressure gauge to the main oven injector

- 1 Check the supply pressure by turning the grill on and oven thermostat to Mark 9. Then turn on the electricity supply. Allow the grill burner to light.

The pressure should be:

Natural Gas 20mbar

L.P.G. Gas The pressure must be set to 28mbar for use on butane or 37mbar for use on propane.

- 2 Turn off the electricity supply and the thermostat; disconnect the pressure gauge.

RATING PLATE REFERENCE

MAKE AND MODEL NO.	SERIAL NO.	DATE OF PURCHASE	PRODUCT NO.

IMPORTANT NOTICE

In line with our continuing policy of research and development, we reserve the right to alter models and specifications without prior notice.

This handbook is accurate at the date of printing, but will be superseded and should be disregarded if specifications or appearance are changed.

Zanussi Limited, Zanussi House, Hambridge Road, Newbury, Berkshire, RG14 5EP.
Telephone (01635) 521313



PART NO: 311359904
1998

Free Manuals Download Website

<http://myh66.com>

<http://usermanuals.us>

<http://www.somanuals.com>

<http://www.4manuals.cc>

<http://www.manual-lib.com>

<http://www.404manual.com>

<http://www.luxmanual.com>

<http://aubethermostatmanual.com>

Golf course search by state

<http://golfingnear.com>

Email search by domain

<http://emailbydomain.com>

Auto manuals search

<http://auto.somanuals.com>

TV manuals search

<http://tv.somanuals.com>