

INSTRUCTIONS FOR THE USE AND CARE OF ZANUSSI MIXED FUEL COOKERS

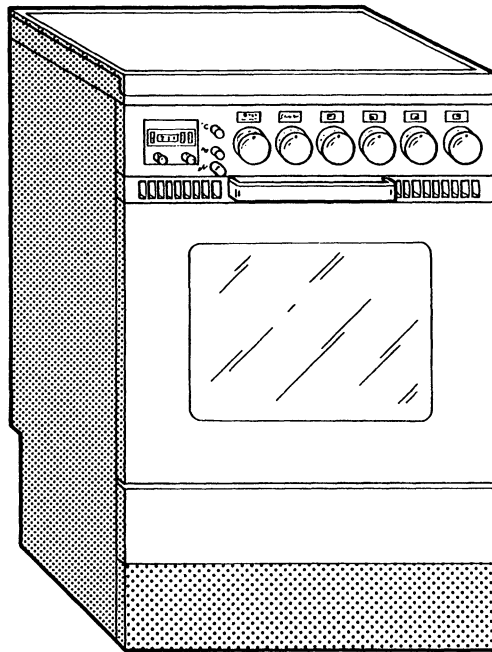

Model No: MC 9634
MC 5634

ZANUSSI
The appliance of science

It is most important that this instruction book should be retained with the appliance for future reference. Should the appliance be sold or transferred to another owner, or should you move house and leave the appliance, always ensure that the book is supplied with the appliance in order that the new owner can be acquainted with the functioning of the appliance and the relevant warnings.

Warnings - Mixed fuel cookers

THESE WARNINGS ARE PROVIDED IN THE INTEREST OF SAFETY. YOU MUST READ THEM CAREFULLY BEFORE INSTALLING OR USING THE APPLIANCE.

This appliance is designed to be operated by adults. Children should not be allowed to tamper with the controls or play with the product.

Any installation work must be undertaken by a competent, authorised installer in accordance with the Gas Safety (Installation and Use) Regulations 1984 and the relevant codes of practice. In the U.K. C.O.R.G.I. registered installers (including regions of British Gas) undertake the work to safe and satisfactory standards.

Any electrical work required to install the appliance should be carried out by a qualified or competent person.

It is dangerous to alter the specifications or modify the product in any way.

This appliance should be serviced by an authorised Zanussi Network Service Centre, and only genuine Zanussi spare parts should be used.

Cookers become very hot with use, and retain their heat for a long period after use. Children should be supervised at all times and should not be allowed to touch

the hot surfaces or be in the vicinity when in use or until the appliance has cooled after use.

Always ensure that the control knobs are in the «off» position when not in use.

The lid is designed as a dust cover when closed, and as a splash-back when open. Do not use for any other purpose.

After using the cooker, the glass lid fitted MUST NOT be closed until the hob and oven are completely cold. If you lower the glass lid when the hob or oven are still hot or warm, the glass may shatter and could cause injury.

Always remove any spillage from the surface of the cover before removal or opening (if applicable), and the appliance should be allowed to cool before replacing or closing the cover.

For hygiene and safety reasons, this appliance should be kept clean at all times. A build-up of fats or foodstuffs could result in a fire.

This appliance has been designed for cooking edible foodstuffs only, and must not be used for any other purposes.

Never line any part of the oven with aluminium foil.

Unstable or misshapen pans should not be used on the burner as unstable pans can cause an accident by tipping or spillage.

Easy clean liners should never be cleaned with any other than detergent water (see cleaning instructions).

Easy clean liners should never be cleaned with any other than soapy water (see cleaning instructions).

This appliance is designed to be used only with natural gas.

Before any maintenance or cleaning work is carried out on the appliance, always take out the plug from the wall socket.

Ensure that the anti-tip oven shelves are put in place in the correct way (see instructions).

All gas appliances require adequate ventilation. Failure to provide this could result in a lack of oxygen. Your installer will advise if in doubt.

Always ensure that the oven vent which is located at the centre back of the hob is left unobstructed to ensure ventilation of the oven cavity.

Only oven-proof dishes are to be stored in the drawer beneath the oven. Do not store combustible materials.

Under no circumstances should you attempt to repair the appliance yourself. Repairs carried out by inexperienced persons may cause injury or more serious malfunctioning. Refer to your local Zanussi Service Centre. Always insist on genuine Zanussi spare parts.

Contents

Installation	Page 5
Technical data	Page 5
Use and care	Page 6
Gas hob	Page 8
Using the oven	Page 10
Digital clock/analogue programmer	Page 12
Using the grill	Page 15
Upkeep and cleaning	Page 17
Removing the oven door	Page 19
Oven lamp replacement	Page 20
What happens if something goes wrong	Page 21
Zanussi guarantee conditions	Page 22

Warning

Please remember that an appliance used for cooking does get hot, so make sure that children are kept well away.

Important

Where the cooker is fitted with a lid, the lid must be completely raised before the cooker will function.



Installation

It is mandatory that all operations required for the installation be carried out by **QUALIFIED PERSONNEL** in accordance with existing rules and regulations.

The relevant instructions are to be found in the special book for the installer.

This appliance meets the requirements laid down in EEC Directive No. 87/308 dated 2/6/87 relating to the suppression of radio and TV interferences.

When the oven is first installed

Once the oven has been installed it is important to remove the protective materials which were put on in the factory.

Switch the oven control to MAX and leave it to run, empty, for 30 minutes to remove any unpleasant new smells.

Technical data

Model number: MC 9634 - MC 5634

Dimensions

Height	900 mm
Depth	595 mm
Width	597 mm
Oven capacity	1.9 cu. ft.

Hob

Rear left heat area	(N) 2000 W
Front left heat area	(R) 3200 W
Rear right heat area	(N) 2000 W
Front right heat area	(S) 1000 W
Maximum power absorbed	8.2 kW

N = Normal burner

R = Rapid burner

S = Simmer burner

Oven

Traditional oven element rating	2.0 kW
Grill element rating	2.0 kW
Double grill element rating	3.0 kW
Convection oven element rating	2.5 kW
Oven lamp	15 W
Convection fan rating	25 W
Maximum power absorbed	3.015 kW
Power supply (50 Hz)	240 V
Total power	11.215 kW

Use and care

- A - Glass lid
- B - Safety cut off
- C - Semi-rapid burner
- D - Rapid burner
- E - Control panel
- F - Shelf supports
- G - Shelves
- H - Oven door
- I - Removable drawer
- J - Front panel
- K - Base
- L - Auxiliary burner
- M - Semi-rapid burner
- N - Electrical cut off

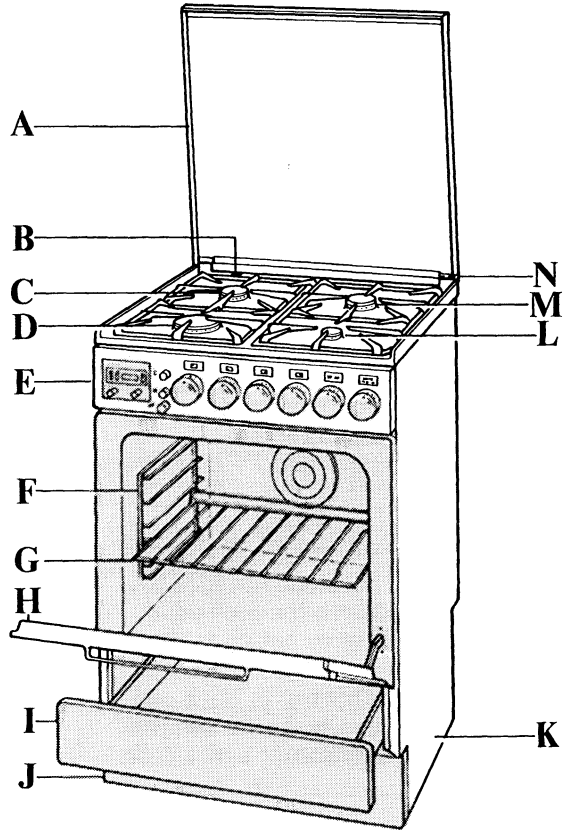

- O - Grill/roasting pan, large
- P - Reversible grill trivet
- Q - Removable handles (2 Off.)

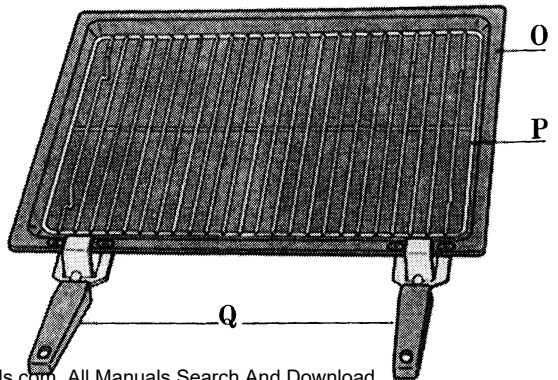

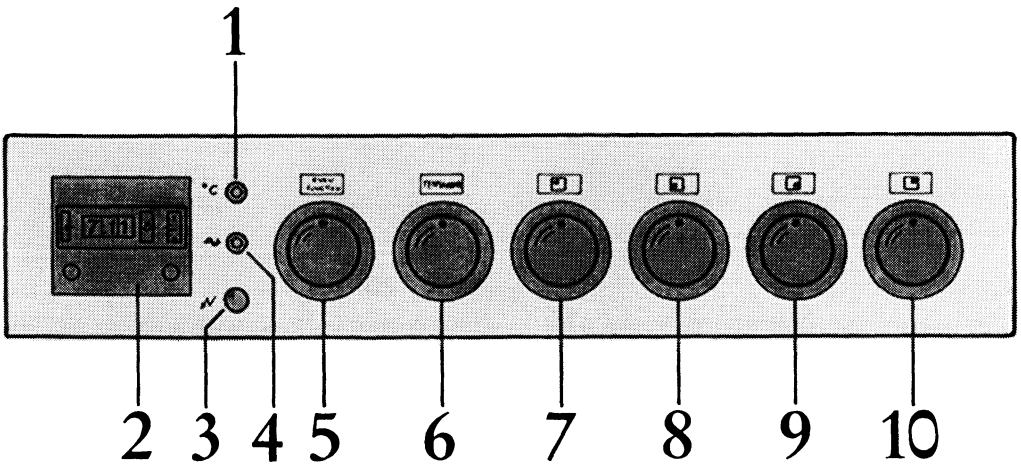

Control panel

- | | |
|------------------------------|-----------------------------|
| 1 - Thermostat control light | 6 - Oven thermostat knob |
| 2 - Electric programmer | 7 - Semi-rapid burner knob |
| 3 - Ignition button | 8 - Rapid burner knob |
| 4 - Mains-on light | 9 - Auxiliary burner knob |
| 5 - Oven selector knob | 10 - Semi-rapid burner knob |

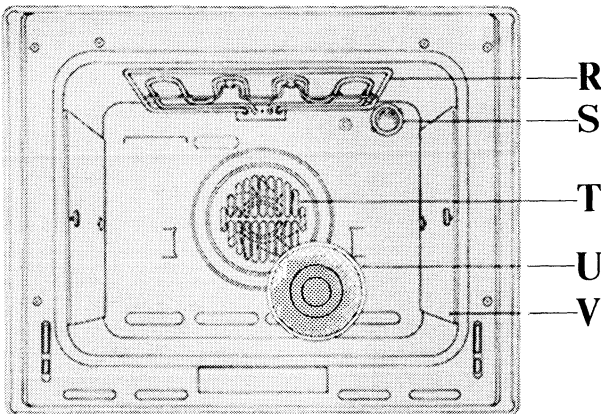

Oven

- R - Grill
- S - Oven light
- T - Fan
- U - Filter
- V - Oven liners

Gas hob

The control panel incorporates knobs to operate the four gas burners.

To light a worktop burner, turn the relevant knob (Fig. 1) to the large flame symbol which corresponds to the maximum setting.

Depress the ignition pushbutton (⚡) on the fascia panel. Once the burner is alight adjust the flame as required. The smaller flame symbol is a simmer setting.

It is important that pans with a base fitting the size of the burner be used so that the flame does not spread beyond the bottom of the pan.

Important

Be very careful when frying food in hot oil or fat as the overheated splashes could easily flare up.

Fig. 1

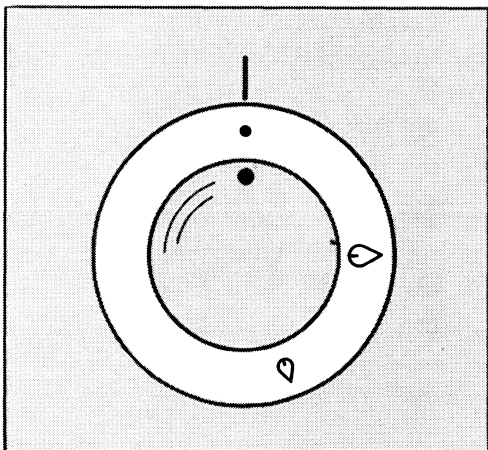

Safety cut off

Your cooker is fitted with a safety cut off device which is actuated when the lid is lowered. This cuts the electricity and gas supply to the whole appliance, and prevents the lid being lowered onto the burners when they are still on. When the lid is raised again, the electricity supply to the oven is automatically restored. The gas supply to the hob must be restored manually by depressing the pushbutton on the rear left hand corner of the hob surface.

There are two important points to remember; firstly the lid must be in the raised position for any part of the cooker to function. Secondly, you must remember to return all the controls to their off positions when you have finished using the cooker. If you have for instance left the oven on, when the lid is raised it will automatically come on again. Obviously if you manually restore the gas supply and any of the burner controls have not been returned to their off positions, the gas will escape.

Safety cut-off switch

Do not tamper with or attempt to adjust the safety cut-off switch. Any adjustment must be made by a qualified engineer. The switch is designed to prevent the hob or oven being turned on when the lid is closed.

Tampering with the switch may enable the heat to be turned on with the glass lid in the down position. The heat would cause the glass lid to shatter which could result in injury. Should you find the switch not functioning correctly, contact your local authorised Zanussi Service Centre.

Using the oven (Multifunction)

The multifunction oven makes it possible to carry out various types of cooking, depending on the nature of the food and its volume.







All cooking must be done with the oven door closed.

The oven light remains on with all cooking functions.

The oven control knob symbols are listed together with a brief description of the functions (a more detailed explanation of the functions and how to use them are given in the «Art of Cookery» book).

Oven control knob (Fig. 2)

By turning this control knob, you can select any of the following functions:

-  Oven light, this will come on whenever the oven is in use.
-  Traditional cooking, uses the top and bottom element for single shelf cooking; this function will enable you to use your favourite recipes without having to adapt the temperatures. It is necessary to pre-heat the oven in this instance.
-  Top oven element only, enables you to finish off dishes on the top only.
-  Bottom oven element only, enables you to finish off dishes on the bottom only.
-  Inner grill element only.
-  Inner and outer grill elements.
-  Ventilated grilling, gives a spit roast effect to all joints. Using this system eliminates the need to turn food during cooking, although large food items may require to be turned half way through the cooking time. Select a max-temperature of 225°C.

Note: The grill cannot be used at the same time as the oven.

Caution

The appliance must never be left unattended whilst grilling.

 Cuisinair cooking; this fan ducted system will allow you to roast or bake at the same time with very little flavour transference, and on any shelf. For this function the circular element and fan behind the back wall of the oven are used.

 Defrost setting (N.B: This is NOT a cooking position). This position is intended to assist thawing of frozen foods.

Caution

Do not place pans, dripping pans, biscuit pans or aluminium foil on the oven bottom. This could cause a heath build-up which would affect the baking results and damage oven enamel.

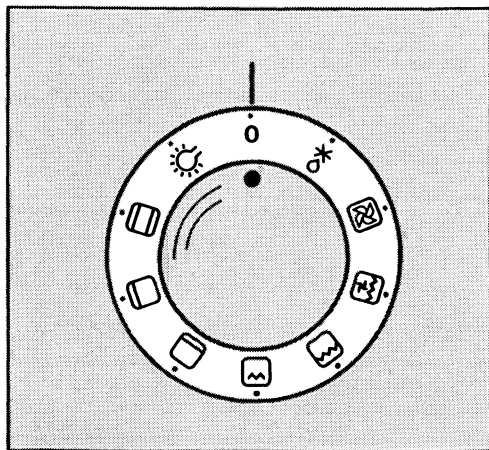

Fig. 2

Thermostat control knob (Fig. 3)

By turning the thermostat control knob clockwise you select the cooking temperature. Temperature selection starts at 50 °C and is marked in 10 °C increments up to maximum, where the temperature at the centre of the oven will reach approximately 280 °C. The thermostat controlling the temperature is totally variable so it is possible to select temperatures between those marked. The MAX setting is particularly suitable for grilling. Once the oven temperature has been selected, the temperature light will come on and remain on until the oven has reached the correct temperature; after that it will come on and off with the thermostat showing how the temperature is being maintained.

During cooking the oven door should be opened as little as possible to avoid heat loss and so excessive electricity consumption.

Safety thermostat

Should the main oven thermostat fail, the oven is protected by a safety thermostat which will operate if the temperature within the oven reaches too high a level. Once the temperature has returned to a safe level the safety thermostat will switch back on and the oven will re-start. In cases where this is a permanent failure it is necessary to contact the Zanussi Network Service Engineer.

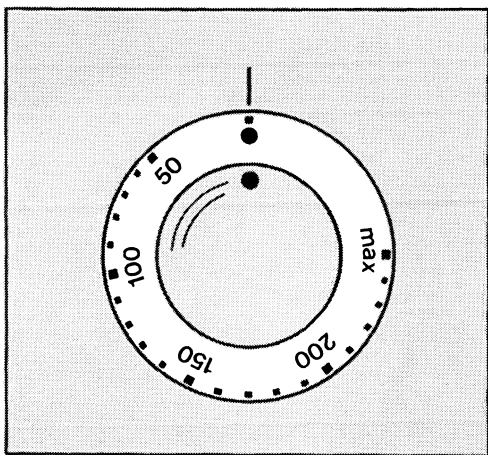

Fig. 3

Operation of the digital clock/ programmer

This programmer enables you to switch the oven on and off at pre-set times without the need for you to be in attendance.

The time of day is also shown. Most foods cook well automatically, but preference should be given to those which will not be affected by the waiting period before the oven comes on.

To set the minute minder

By turning knob A clockwise you can set the minute minder.

By pulling knob A outwards you can set the correct time of day. It will be necessary to do this on installation of the appliance, after a power failure or when the clock is fast or slow.

Knob B

By turning this knob clockwise you can enter on dial D the required duration of cooking, up to a maximum of 310 minutes.

To operate the oven manually, turn knob B, so that the hand symbol  is centred on dial D.

By pulling this knob outwards and turning it clockwise you can enter on dial E the cooking start time (up to 12 hours in advance).

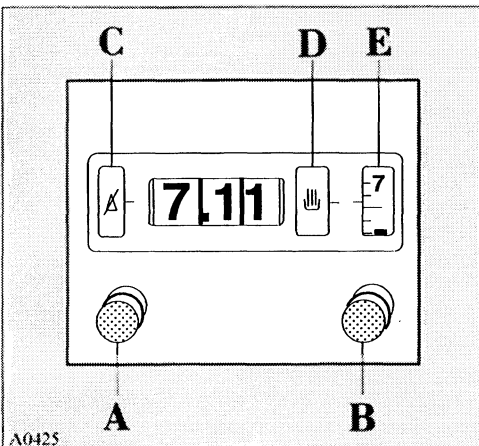

Fig. 4

Important

Before programming the cooking you must ensure that dial D shows symbol «0». If it is not, do so by turning knob B clockwise.

Manual operation of oven

To operate the oven manually, turn knob B so that the hand symbol is centred on dial D.

Place the foods to be cooked into the oven and select the required positions on the oven and thermostat control knobs.

Semi automatic operation of oven

Manual Cooking Start - Automatic Cooking Stop

You may wish to put something in the oven before going out and programme the oven to stop cooking before your return.

Place the food to be cooked into the oven.

Turn knob B clockwise and set the required duration of cooking time on dial D (maximum of 310 minutes).

Turn the oven and thermostat control knobs to the required settings.

Important: when setting a cooking programme, make sure that both the electric clock and dial E show the same time.

Totally Automatic Cooking

This enables you to turn the oven on and off at pre-set times. Place the food to be cooked into the oven.

Check that dial D shows symbol «0». If it is not, do so by turning knob B clockwise.

Pull knob B outwards and turn it clockwise to set on dial E the required cooking start time.

Press and turn knob B clockwise to set on dial D the required cooking duration.

Turn the oven and thermostat control knobs to the required settings.

On completion of the programmed cooking cycle the «0» symbol will be centred on dial D, in this position the electricity supply to the oven is switched off thereby turning off the oven.

Important

To stop an automatic programme turn the knob B clockwise to centre on dial D the symbol «0».

To finish the cooking manually, turn knob B clockwise to centre on dial D the hand symbol  .

Example of programmer setting with automatic operation of the oven

Cooking start time: 17.00 hours.

Cooking duration: 2 hours.

Place the food into the oven.

Check that symbol «0» is shown on dial D. Pull knob B outwards and turn it clockwise to set on dial E the cooking start time (5=17.00 hours).

Press and turn knob B clockwise and set cooking duration on dial D (2 hours).

Turn the oven and thermostat control knobs to the required settings.

After this the oven will automatically turn on at 17.00 hours and then turn off at 19.00 hours after completion of the cooking programme.

Minute Minder

The programmer will operate as a minute minder provided no automatic cooking has been programmed.

To operate the minute minder turn knob A clockwise, setting on dial C the required duration of cooking time (maximum of 60 minutes). The sound alarm will indicate when the pre-set time has elapsed. To turn off the alarm turn knob A clockwise to centre on dial C the crossed bell symbol ().

Using the grill

To switch on the grill turn the oven control knob to either ☐ or ☐ symbol, then turn the thermostat knob to the required temperature setting.

Turning the oven control knob to the ☐ symbol operates the inner element only, when the oven control knob is turned to the ☐ symbol both the inner and outer elements operate, the latter provides a larger grilling area.

This is known as a dual element.

Foods to be grilled should be placed on the wire trivet in the grill pan, the trivet can be positioned either way up to give the required distance from the element.

Caution

The appliance must never be left unattended whilst grilling.

Note:

We recommend that you wipe fat splashes off the grill element **when it is cold** in order to prevent smoking from the fat as it burns off when the grill is next used.

Important

Your oven door is fitted with hinges, giving two door positions, fully opened or fully closed.

When grilling, the oven door must be closed.

Grilling with the door open could cause areas of the oven to become excessively hot as well as reducing the performance, efficiency and economy of the grill.

Shelves and runners

This Zanussi cooker has four shelf positions. The anti-tip feature is achieved by the closeness of the shelf runners. The auto-stop feature is achieved by two metal stops fixed to the shelves, as the shelf is moved in and out the metal stops catch on the bottom of any pair of shelf runners, if the shelf is wrongly positioned these stops will not catch, therefore it is important to position the shelves as shown (Fig. 5).

Grease filter

When roasting meat, be sure to install the special grease filter to protect the fan in the rear wall of the oven from fat splashes.

After roasting is completed, remove the grease filter and clean thoroughly with warm detergent water. As it is stainless steel you can safely wash it in the dishwasher.

To remove the grease filter, pull up the protruding tongue and then pull the filter outwards removing it from the rear panel (Fig. 6).

To replace the filter, hold the protruding tongue and slide down onto the slots in the rear wall of the oven so that it clips on.

Storage drawer

The storage drawer is located underneath the oven cavity.

During cooking the storage drawer may become hot if the oven is on high for a long period of time, therefore flammable materials such as oven gloves, tea towels, plastic aprons etc. should not be stored in the drawer.

Obviously, oven accessories such as baking sheets, will also become hot; therefore care should be taken when removing these items from the drawer when the oven is in use or still hot.

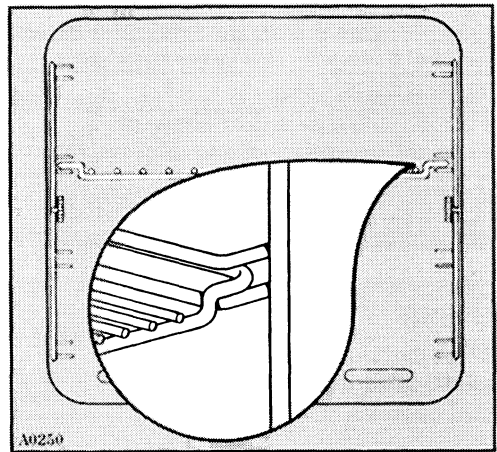

Fig. 5

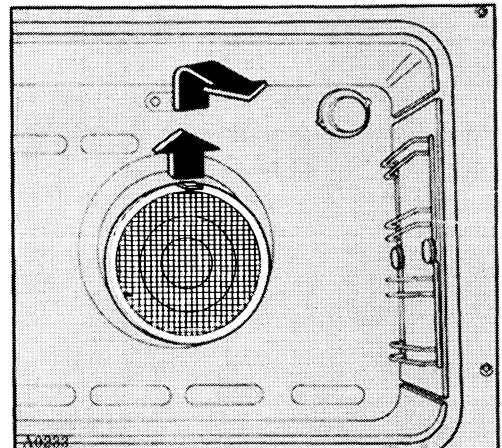

Fig. 6

Upkeep and cleaning

Cleaning your gas hob

The hob is best cleaned whilst still warm as any spills from cooking will be removed more easily than if left to cool. Wipe the hob and pan supports, with a soft cloth soaked in warm detergent water. Do not use abrasive scourers or steel wool. For more stubborn marks a mild scouring cream may be used, but care must be taken not to scratch the enamelled surface of the hob.

Cleaning the oven

Glass door

This should be cleaned with a soft cloth soaked in warm soapy water. Do not use abrasive scourers or steel wool.

Shelves and shelf supports

To clean the chrome parts of the oven, soak in warm detergent water and remove stubborn marks with a well wetted soap impregnated pad. Rinse well and dry with a soft cloth. Do not use abrasive scourers or steel wool.

Oven cavity

The enamelled oven cavity is best cleaned whilst the oven is still warm.

It is preferable/advisable to wipe the oven over with a soft cloth soaked in warm detergent water after each use. However, from time to time it will be necessary to do a more thorough cleaning using a proprietary oven cleaner, do not use aerosol oven cleaners, abrasive scourers or steel wool.

Special oven linings

This cooker is fitted with a set of coated liners. These are known as «stay clean» or «easy care». To obtain the maximum efficiency from your liners follow the guide lines carefully for their use and care.

The linings are coated with a special substance which helps to clean itself by a process of oxidization. Although the linings will not remain absolutely spotless they will reduce your oven cleaning chores considerably when used in the correct way.

The linings work most effectively if the splashes are kept to a minimum, and the soil is not allowed to build up, as this will retard the cleaning action. If the oven has been used at low temperatures it should be heated for one hour on 200 °C. Never use abrasive wools or pads or an aerosol oven cleaner on the coated linings.

Removal/replacement of the oven liner panels

It is not necessary to disconnect the appliance from the electricity supply when removing the side panels. However, you must disconnect the electricity supply before attempting to remove the back panel, by turning off at the wall socket or cooker box.

From time to time it will be necessary to remove the oven liner panels to facilitate cleaning. To do this proceed as follows:

1. Unscrew the ring nuts securing the side runners, and remove the runners (Fig. 7).
2. Slide the side panels towards you to release them from their retaining pins, then lift away from the oven wall (Fig. 8).
3. Make sure that the electricity supply to the appliance is disconnected. Then

using a suitable Phillips screwdriver unscrew the four fixing screws on the back panel, and lift the panel away (Fig. 9). This is a good opportunity to clean the rear side of the back panel. 4. To replace the panels, reverse the above procedure.

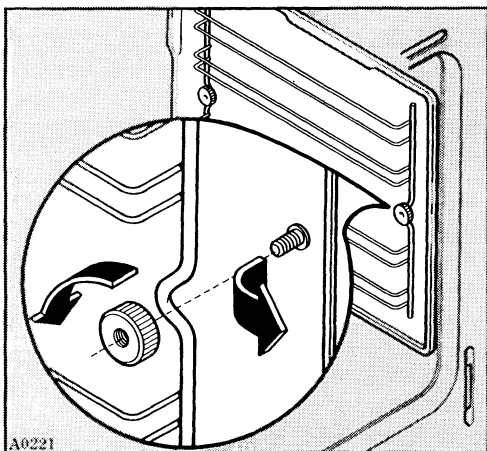

Fig. 7
18

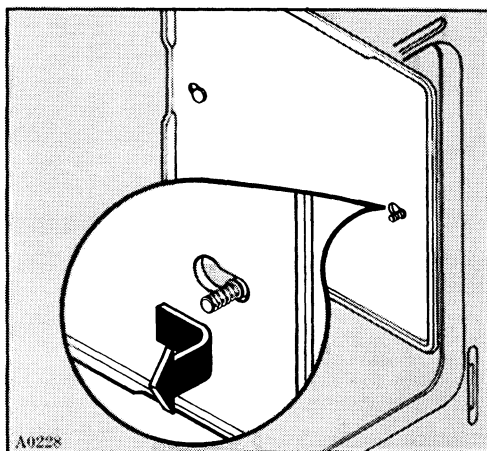

Fig. 8

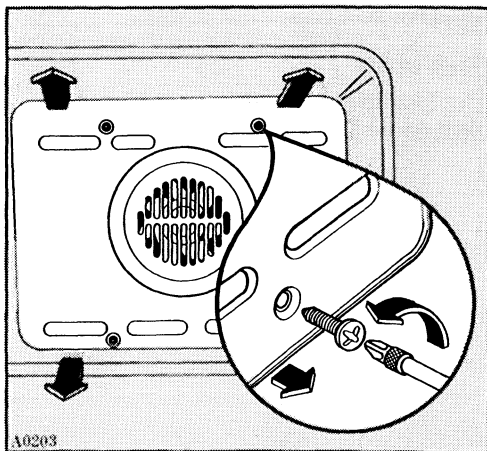

Fig. 9

Removing the oven door

(Fig. 10 A, B, C.)

Warning

It is important that the retaining discs are fully turned and located as the hinges are under high sprung tension.

1. Open the oven door so that it is in the horizontal position.
2. With the aid of a coin move the two retaining discs a quarter turn clockwise, so that the two raised bars are to the left hand side of the hinges.
3. Raise the door halfway.
4. At this stage the two hinges on either side of the door must be clasped together simultaneously. The door can then be removed by pulling out and downwards, maintaining the angle.

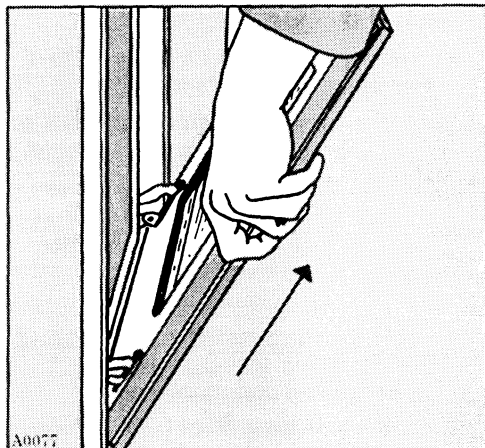

Fig. 10/B

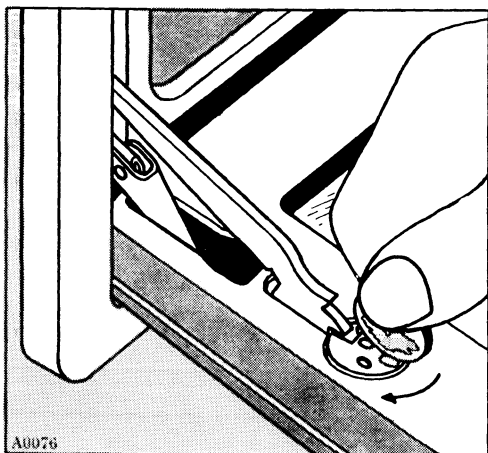

Fig. 10/A

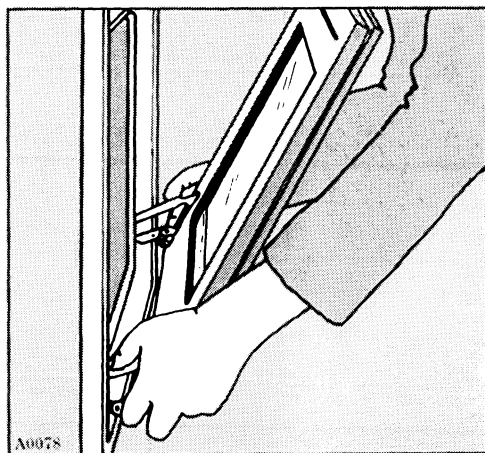

Fig. 10/C

To replace the door

1. Clasp the two hinges on either side of the door together simultaneously.
2. Hook the top hinge into the top slot so that the hook is engaged with the roller.
3. Drop the lower hinge into the lower slot, so that the notch is engaged. Drop the door down so it is in the horizontal position.

Note. It is very important when carrying out this operation that both hinges should be located simultaneously.

4. Turn the retaining discs back a quarter turn so that the two raised bars are opposite the hinges.

The door can then be closed.

Replacing appliance components

Prior to undertaking any maintenance work or replacing the oven lamp or grill heating element, be sure to disconnect the appliance from the electricity supply.

Oven lamp replacement

Push in and unscrew anticlockwise the glass cap (Fig. 11). Remove the faulty bulb and replace with one that withstands temperatures (300 °C). Electric bulb: 15W, 240V, 50 Hz, 300 °C, E14. Bulbs are available from your Zanussi Service Network.

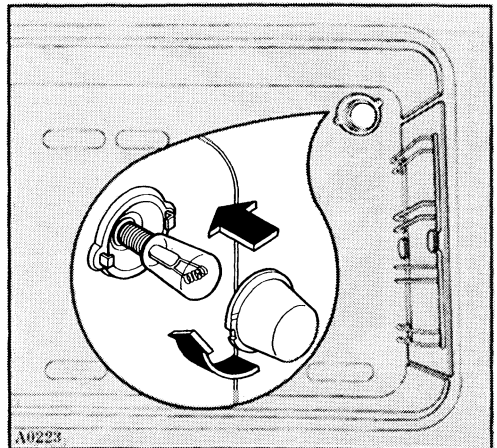

Fig. 11

What happens if something goes wrong

If the appliance fails to operate:

1. If the oven does not come on check that the programmer is properly set for manual operation, or that you have programmed any automatic cooking correctly.
2. Check that the hob cover, where present, is in the raised position.
3. Check that it is properly plugged in.
4. Check that the socket switch is turned on.
5. Check that the socket is supplying power - do this by plugging in another appliance that is known to be working properly.
6. Check that the fuse in the plug is intact.
7. If the hob area does not work, check that you are turning the correct control knob.
8. Check that you have manually re-set the gas supply.

IF YOU SUSPECT A GAS LEAK, TURN ALL CONTROLS TO THEIR OFF POSITIONS, AND TURN THE MAINS GAS SUPPLY OFF IMMEDIATELY. THEN CONTACT YOUR GAS BOARD.

If after all these checks, the oven still does not work, telephone for your local Zanussi Service Centre, listed in the telephone directory. It helps to jot down the name and address and telephone number in the space below.

IN-GUARANTEE CUSTOMERS SHOULD ENSURE THAT THE ABOVE CHECKS HAVE BEEN MADE AS THE ENGINEER WILL MAKE A CHARGE IF THE FAULT IS NOT A MECHANICAL OR ELECTRICAL BREAKDOWN.

*** Please note that proof of purchase is required for any in-guarantee service calls.**

Name _____

Address _____

Telephone Number _____

Peace of mind for twelve months

ZANUSSI STANDARD GUARANTEE CONDITIONS

This guarantee is in addition to your statutory and other legal rights which will not be excluded or in any way diminished by the return of this guarantee card.

We, Zanussi Ltd, undertake that if, within twelve months of the date of the purchase, this ZANUSSI appliance or any part thereof is proved to be defective by reason only of faulty workmanship or materials, we will, at our option, repair or replace the same **FREE OF ANY CHARGE** for labour, materials or carriage on condition that:

The appliance has been correctly installed and used only on the electricity supply stated on the rating plate.

The appliance has been used for normal domestic purposes only, and in accordance with the manufacturer's operating and maintenance instructions.

The appliance has not been serviced, maintained, repaired, taken apart or tampered with by any person not authorised by us.

The appliance is still in the possession of the original purchaser.

All service work under this guarantee must be undertaken by a Zanussi Network Service Centre.

Any appliance or defective part replaced shall become our property.

Exclusions

Damage or calls resulting from transportation, improper use or neglect, the replacement of any light bulbs or removable parts of glass or plastic.

Costs incurred for calls to put right machines improperly installed or calls to machines outside the UK and the Republic of Ireland.

Appliances found to be in use within a commercial environment, plus those which are the subject of rental agreements.

Television receivers-routine adjustment, or poor reception resulting from a source outside of the receiver.

**How to find the telephone number of
your
Zanussi Service Force
listed in this leaflet**

Zanussi Service areas are allocated by postcodes which are listed in alphabetical order for easy reference.

1. Look for the two letters of your address postcode in the far left 'Postcode' column.
2. Match up the number of your postcode against the number listed in the 'Postcode Numbers' column.
3. Look across the column to the Service Force Key Number for your area. Turn to the last page of this directory for the address and telephone number to contact for service which is listed against your key number.

If you are unsure of your postcode, the main towns and cities are listed in alphabetical order for easy reference.

Additionally, your local Zanussi Service Force Centre telephone number is listed under 'Z' in your telephone directory.

The Customer Care Department at Zanussi House, Hambridge Road, Newbury, RG14 5EP, Tel: 0635 521313, will be happy to help you with any queries or difficulties.

For Service In The Republic Of Ireland

The telephone number of your service centre can be found in your Local Telephone Directory under 'Elektro Service' or 'Zanussi'. The information can also be found in the Golden Pages under 'Electrical Appliances - Repairing'.



Post-code Letter	Town	Post-code Number	Service Force Key Number	Post-code Letter	Town	Post-code Number	Service Force Key Number
AB	Aberdeen	1-5, 22-23, 30-38	1	DG	Dumfries	13	35
AB		41-45, 51-56	1	DH	Durham	1-9	37
AL	St Albans	1-10	2	DL	Darlington	1-17	37
A	Brecon	45	3	DN	Doncaster	1-7, 10-12, 22	33
BA	Bath	1-5, 11-15	4	DN		14	38
BA		7-10, 20-22	5	DN	Doncaster	8-9, 15-21, 31-40	39
BA		6, 16	6	SUB POSTCODE DIVISION			
BB	Blackburn	1-12	7	DN	Gainsborough		
BD	Bradford	1-23	8		South	21-1, 21-2, 21-5	40
BD		24	7	DN	Gainsborough		
BH	Bournemouth	1-25	9		North	21-3, 21-4	39
BL	Bury	0-9	11	DT	Dorchester	1-5, 10-11	9
BN	Brighton	1-15	12	DT		6-9	5
BN		20-27	12	SUB POSTCODE DIVISION			
BN		16-18	13	DT	Bridport East	6-3, 6-4	5
BR	Bromley	1-8	14	DT	Bridport West	6-5, 6-6	5
BS	Bristol	1-28, 88-89	15	DY	Dudley	1-6, 8-9	17
BT	Belfast	1-82	16	DY		7, 10-14	41
B	Birmingham	1-21, 25-33, 38, 40	17	EC	London	All EC Codes	28
B		45, 47-48, 60-71	17	EH	Edinburgh	1-42, 46, 52-54	42
B		80, 90-94, 97-98	17	EH		43-45	35
B	Birmingham	23-24, 34-37,	18	EH	Edinburgh	47-49, 51, 55	43
B		42-44, 46, 72-79	18	EN	Enfield	1-11	28
B	Birmingham	49-50,	20	EX	Exeter	1-17, 20	45
B		96	19	EX		18-23, 31-39	46
B	Birmingham	95	20	E	London	All East Codes	28
CA	Carlisle	1-28	21	FK	Falkirk	1-4	43
CB	Cambridge	1-8	22	FK		10-14, 18-19	32
CB		9-11	23	FK	Falkirk	5-9, 15-17	47
CF	Cardiff	1-8, 31-48	3	FK		20-21	31
CH	Chester	1-4	24	FY	The Fylde	0-8	7
CH		5-7	25	GCI	Guernsey		48
CH		8	26	GL	Gloucester	1-19	49
CM	Chelmsford	0-6, 8-9, 11-15	27	GL		50-56	49
CM		7	23	GL		20	19
CM	Chelmsford	16-24	28	GU	Guildford	1-24, 26, 34-35	50
CO	Colchester	1-16	23	GU		25	51
CR	Croyden	0-9	29	GU	Guildford	27-33	13
CT	Canterbury	1-21	36	G	Glasgow	1-5, 11-15, 20-23,	47
CV	Coventry	1-8, 10-12, 21-23	20	G		31-34, 40-46, 51-	47
CV		9, 13	18	G	Glasgow	53, 58, 60-69, 73,	47
CV	Coventry	31-37	20	G		76-78, 81-84	47
CW	Crewe	1-12	30	G	Glasgow	71-72, 74-75	43
DA	Dartford	1-18	29	HA	Harrow	0-9	2
DD	Dundee	1-5, 7-11	31	HD	Huddersfield	1-8	8
DD		6	32	HG	Harrogate	1-5	8
DE	Derby	1-3, 6-7, 13-15	10	HP	Hemel	1-3	2
DE		11-12	18	HP	Hempstead	4-23	53
DE	Derby	4-5, 55	33	HR	Hereford	1-2, 4, 6-9	49
DG	Dumfries	1-7, 10-12, 14	34	HR		3, 5	54
DG		8-9	34				

Post-code Letter	Town	Post-code Number	Service Force Key Number	Post-code Letter	Town	Post-code Number	Service Force Key Number
HU	Hull	1-20, 55	38	NE		98-99	66
HX	Halifax	1-7	8	NE		71	35
IG	Ilford	1-11	28	NG	Nottingham	1-14	10
IOM	Isle of Man		55	NG		15-22, 25	33
IP	Ipswich	1-15, 30-31	56	NG	Nottingham	23-24	40
IP		16-27	57	NG		31-34	64
IP	Ipswich	28-29, 32-33	22	NN	Northampton	1-7, 11-12	67
IV	Inverness	1-24, 26, 30-36,	58	NN		8-10, 14-18	22
IV		40-49, 51-56	58	NN	Northampton	13	65
IV	Inverness	25, 27-28	59	NP	Newport	1-9, 44	3
JCI	Jersey		60	NR	Norwich	1-35	57
KA	Kilmarnock	1-26, 29-30	43	NW	London	All NW Codes	52
KA		27	61			Except 2, 4, 7, 9, 10	
KA		28	68	NW	London	2, 4, 7, 9, 10	2
KT	Kigston-on-Thames	1-23	51	N	London	All N Codes	28
KT		24	50	OL	Oldham	1-12, 15-16	11
KW	Wick	1-14	59	OL		13-14	7
KW		15-17	62	OX	Oxford	1-17	65
KY	Kirkcaldy	1-16	32	PA	Paisley	1-4	47
LA	Lancaster	1-23	7	PA		5-19	43
LD	Llandrindod	1-8	54	PA	Paisley	20-27	68
LD		3	3	PA		28-29, 41-49, 60-61	69
LE	Leicester	1-5, 7-8, 11-14,	63	PA	Paisley	30-40	70
LE		16-17	63	PA		62-78	48
LE	Leicester	6, 9-10	63	PA	Paisley	80-82, 88	71
LE		15	64	PA		83-87	72
LL	Llandudno	11-15	25	PE	Peterborough	1-15, 34, 38	64
LL		16-19	26	PE		16-19	22
LL	Llandudno	20-21, 23, 27, 31-	25	PE	Peterborough	20-25	40
LL		32, 34-40, 42-47	25	PE		30-33, 35-37	57
LL	Llandudno	22, 24-26, 28-30,	26	PH	Perth	1-2, 8-9, 10-18	31
LL		33-34, 41, 48-49,	26	PH		3-7	32
LL		51-78	26	PH	Perth	19-26, 30-44	58
LN	Lincoln	1-6, 8-10	40	PL	Plymouth	1-21	73
LN		7, 11-13	39	PL		22-35	74
SUB POSTCODE DIVISION				PO	Portsmouth	1-22	13
LN	Lincoln	3-4, 3-5	40	PO	I.O.W.	30-41	75
LN		3-6	39	PR	Preston	1-9	7
LS	Leeds	1-29	8	RG	Reading	1-17, 26	53
LU	Luton	1-6	2	RG		21-25, 27	50
LU		7	22	RG	Reading	28	4
L	Liverpool	1-49, 60-70	24	RH	Redhill	1-3, 6-7, 9-20	12
ME	Medway	3	29	RH		4-5	50
ME		1-2, 4-20, 99	36	RH	Redhill	8	29
MK	Milton Keynes	1-17, 19, 40-46	22	RM	Romford	1-5, 7, 10-18	27
MK		18	65	RM		6, 8-9	28
ML	Motherwell	1-12	43	SA	Swansea	1-18, 31-32	3
M	Manchester	1-35, 60	11	SA		33-39, 41-44, 61-73	76
NE	Newcastle-on-Tyne	1-49, 61-70, 88	66	SA	Swansea	19-20, 40, 45-48	77
				SE	London	All SE Codes	14
				SG	Stevenage	1-9, 11, 15	2
				SG		10, 12-14	28
				SG	Stevenage	16-19	22

Post-code Letter	Town	Post-code Number	Service Force Key Number	Post-code Letter	Town	Post-code Number	Service Force Key Number
SK	Stockport	1-3, 6-12	30	WD	Watford	3	53
SK		4-5, 13-16	11	WF	Wakefield	1-17	8
SK	Stockport	17	33	WN	Wigan	1-5, 7	11
SL	Slough	1-10	53	WN		6, 8	24
SM	Sutton	1-3, 7	51	WR	Worcester	1-14	19
SM		4-6	29	WR		15	41
SN	Swindon	1-8, 11-16	65	WS	Walsall	1-15	18
SN		9-10	4	WV	Wolverhampton	1-4, 10-14	18
SO	Southampton	1, 4, 41-43, 51	9	WV		5-9, 15-16	41
SO		1-3, 5, 21-24, 52	13	W	London	All West Codes	52
SO	Southampton	20	4			Except 1-14	
SP	Salisbury	1-5, 9-11	4	W	London	3, 4, 5, 7, 13	2
SP		6	9	W	London	1-2, 6, 8-12, 14	44
SP	Salisbury	7-8	9	YO	York	1-3, 5, 7-8	8
SR	Sunderland	1-7, 9	66	YO		4, 6, 11-18, 25	38
SR		8	37	YO	York	21-22	37
SS	Southend-on-Sea	0-9, 11-17, 99	27	ZE	Lerwick	1, 3	79
ST	Stoke-on-Trent	1-18, 20-21	30			2	80
ST		19	18				
SW	London	2, 4, 8-9, 12, 16-17	14				
SW	London	1, 3, 5-7, 10-11	44				
SW	London	13-15, 18	44				
SW	London	19-20	51				
SY	Shrewsbury	1-6, 9-17, 18-22	25				
SY		7, 17-19	54				
SY	Shrewsbury	8	41				
SY		23-25	77				
S	Sheffield	1-19, 30-31, 40-45	33				
S		60-66, 74, 80-81	33				
S	Sheffield	70-73, 75	8				
TA	Taunton	1-11, 21-24	6				
TA		12-20	5				
TD	Selkirk	1-15	35				
TF	Telford	1-8, 10-13	41				
TF		9	30				
TN	Tonbridge	1-2, 4, 8-11, 13-16	29				
TN		12, 17-18, 23-40	36				
TN	Tonbridge	3, 5-7, 19-22	12				
TQ	Torquay	1-6, 9, 12-13	78				
TQ		7-8	73				
TQ	Torquay	14	45				
TR	Truro	1-27	74				
TS	Stockton-on-Tees	1-29	37				
TW	Twickenham	1-20	51				
UB	Uxbridge	1-10	2				
WA	Warrington	1-5, 8, 9, 10-15	11				
WA		6-7	24				
WA	Warrington	16	30				
WC	London	All WC Codes	44				
WD	Watford	1-2, 4-7	2				

SCP/0011/LW/6.92

Post-code Letter	Town	Post-code Number	Service Force Key Number	Post-code Letter	Town	Post-code Number	Service Force Key Number
1	60 Commerce Street, Aberdeen, AB2 1BP		0224 583949	42	38 Buccleuch St, Dalkeith, Midlothian, EH22		031 663 7758
	or Tel.:		0224 582704	43	Block 2 Unit 5, Auchencraigh Ind. Est, Rosendale		
2**	Unit 4 Riverside Est, Coldharbour Ln, Harpenden		0582 461909		Way, Blantyre		0698 828145
3	3 Penlwyn Road, Blackwood, Gwent, Sth Wales		0495 223151	44	4 Royal Lane, Yiewsley, W.Drayton, UB7		0895 441917
4	31 St Andrews Road, Bemerton, Salisbury, SP2		0722 336072	45	91 Exeter Road, Exmouth, Devon, EX8 1QD		0395 263531
5	3 Bancombe Ct Trad. Est., Martock, Yeovil, TA12		0935 822836	46	Unit 4 Upcroft Ave, Pottington Ind Est, Barnstaple		0271 71774
6	6 Hamp Ind Est, Bridgwater, Somerset, TA6 3NT		0278 424550	47	Unit E6G Anniestand Ind. Est. Netherthorn Rd, Glasgow, Scotland		041 954 5304
7	333 Rangleit Road Walton Summit, Preston, PR5		0772 321200		or Tel.:		041 954 5349
8	57 Ingram Road, Holbeck, Leeds, Yorks		0532 460992	48	Blencathra, Saumarez Lane, Castel, Guernsey		0481 56854
9	63 Curzon Road, Bournemouth, BH1 4PW		0202 303363	49	134 Eastgate Street, Gloucester, GL1 1QT		0452 422488
10	Unit 2, Furnace Road, Ilkeston, Derbyshire		0602 442770	50	Unit 1 Redfields Ind. Pk, Church Crookham, Fleet		0252 851414
11	Unit 41/42 Clarendon Ct, Winwick Quay, Wlton		0925 50822	51	127 Walton Road, Molesey, Surrey, KT8 0DT		081 979 6366
12	Unit 3, 21/25 Bridge Road, Haywards Heath, RH1		0444 417656		or Tel.:		081 979 7962
13	266 Main Road, Southbourne, Emsworth, PO10		0243 374814	52**	Unit 4, Riverside Est, Colharbour Ln, Harpenden		0582 461909
	or Tel.:		0243 371170	53	Reform Road, Maidenhead, Berkshire		0628 783711
14	9 Bourne Road, Bromley, Kent, BR2 9PB		081 313 9533	54	Merior House, High Street, Llandrindod Wells		0597 824642
15	Unit 1, Albert Crescent, Bristol, BS2 0YH		0272 713217	55	Souh Quay Industrial Estate, Douglas, I.O.M.		0624 622114
16	Owenmore Hse, Kilwee Ind. Est., Upper Dunmurry Lane, Belfast		0232 301121	56**	Unit 2b, Eilton Park Business Centre, Hadleigh Road, Ipswich, IP2 0DQ		0473 211713
17	66 Birch Rd East, Wyreley Rd Ind. Est, B'ham		021 327 1671	57	75 Grove Road, Norwich, NR1 3RL		0603 629653
18	Unit 3 Sterling Park, Claymore, Tamworth		0827 289800	58	Unit 3B3, Smithton Ind. Est. Smithton, Inverness		0463 791822
	or Tel.:		0827 289822	59	Drummuie Road, Golspie, Sutherland, KW10 6SY		0408 633517
19	22 Newton Road, Malvern, Worcs, WR14 1NZ		0684 572915	60	P.O.Box45, Queens Road, St Helier, Jersey		0534 67001
20	Unit 23/24, Alliance Business Pk, Townsend Drv, Nuneaton, CV11		0203 350666	61	Bruach, Blackwaterfoot, Isle of Arran		077 086 246
21	High Eghenside, Egremont, Cumbria, CA22		0946 820509	62	Hatson Ind. Estate, Kirkwall, Orkney		0856 5457
22	1 Wharf Road, Higham Ferrers, Northants		0933 317727	63	75 St Marys Road, Market Harborough, Leics		0868 433229
23**	Unit 2b, Eilton Park Business Centre, Hadleigh Road, Ipswich, IP2 1DQ		0473 211713	64	Pinfold Rd, Manning Rd Ind. Est. Bourne, Lincs		0778 422147
24	Unit 14, Dock Road, Birkenhead, L41 1JJ		051 639 1287	65	Unit E19, Telford Rd, Launton Ind. Est. Bicester		0869 248598
25	Plas Fynnon W/house, Middleton Rd, Oswestry		0691 652917	66	Unit C1, Bergen Ct, Tyne Tunnel Trad. Estate, North Shields, Tyne & Wear		091 2960166
26	Easy Launderette, Panton Hall, Denbigh, Clwyd		0745 813272	67	53 Sandringham Road, Northampton, NN1		0604 37061
27	19 Sirdar Rd, Off Brook Rd, Rayleigh, Essex		0268 741171	68	96 Argyll Street, Dunoon, Argyll, PA23 7NE		0369 2147
28	284 Alma Road, Enfield, EN3		081 805 6825	69	Inverarsdale, Gallow Hill Rd, Cambeltown, Argyll		0586 553753
29	Unit B4, Imperial Bus. Estate, Gravesend, Kent		0474 353771	70	Moss Field Workshop, Moss Field Drive, Oban		0631 664530
30	Unit 8, Croft Road, Newcastle under Lyme, Staffs, ST5 0TW		0782 713003	71	2 Killweivagh, Gregory, Benbecula, Outer Hebrides		0870 2331
31	3-7 Blackness Street, Dundee, Scotland, DD1		0382 642828	72	Churchouse, 16 James St, Stornaway, Isle of Lewis		0851 705555
	or Tel.:		0382 455862	73	16 Faraday Mill, Cattedown, Plymouth, PL4		0752 257455
	or Tel.:		0382 826809	74**	80 Killigrew Street, Falmouth, Cornwall, TR11		0326 314600
32	33a Burnside, Auchtermuchty, Fife, Scotland		0337 28807	75	111 Hunnyhill, Newport, Isle of Wight		0983 523062
33	Unit 63, Storforth Ln Trad. Est. Chesterfield		0246 231790	76	Roch, Haverfordwest, Dyfed		0437 710366
34	93 Irish Street, Dumfries, Scotland		0387 96994	77	Unit 16, Llambod Ind. Est., Lampeter, SA48		0570 423424
35	2-8 Wood Market, Kelso, Borders, TD5 7AX		0573 24411	78	278 Torquay Road, Preston, Paignton		0803 529969
36	Unit 2, Bridge Rd Bus. Centre, Bridge Road, Ashford, Kent, TN23 1BB		0233 613463	79	3-4 Carlton Place, Lerwick, Shetland, ZE1		0595 2915
37	8 Cumbie Way, Aycliffe Ind. Est. Newton Aycliffe		0325 300606	80	Harfsdale, Symbister, Whalasaay, Shelland		08066 546
38	Unit 1, Boulevard Unit Fact. Est. Hull, HU3 4AY		0482 223335	81	London House, Victoria Street, Alderney		048182 3563
39	Unit 2, Cromwell Road, Grimsby, DN31 2BN		0472 358760				
40	Unit 14 Stonelfield Park, Clifton Street, Lincoln		0522 532330				
41	1 Underhill Street, Bridgnorth, Salop, WV16		0746 763322				

SCA/0012/LW/4.9:

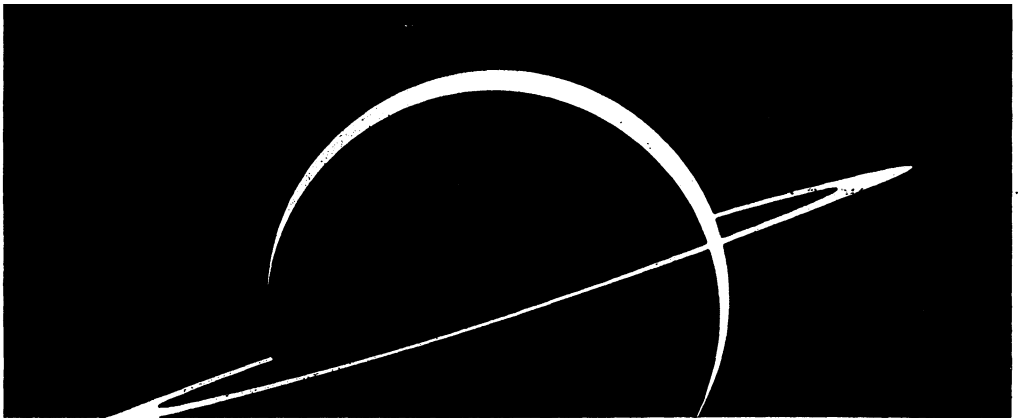

ZANUSSI

The appliance of science

Zanussi Ltd., Zanussi House, Newbury

The information in this manual is correct at time of going to press.
Zanussi reserve the right to alter specifications without notice.

Free Manuals Download Website

<http://myh66.com>

<http://usermanuals.us>

<http://www.somanuals.com>

<http://www.4manuals.cc>

<http://www.manual-lib.com>

<http://www.404manual.com>

<http://www.luxmanual.com>

<http://aubethermostatmanual.com>

Golf course search by state

<http://golfingnear.com>

Email search by domain

<http://emailbydomain.com>

Auto manuals search

<http://auto.somanuals.com>

TV manuals search

<http://tv.somanuals.com>