

ZANUSSI



 Electrolux

MIXED FUEL COOKER

ZCM 531

INSTRUCTION BOOK



WARNINGS



You MUST read these warnings carefully before installing or using the appliance. If you need assistance, contact our Customer Care Department on 08705 727727.

Installation

- This cooker must be installed by qualified personnel, according to the manufacturer's instructions and to the relevant British Standards.
- This cooker is heavy. Take care when moving it.
- Any gas installation must be carried out by a registered CORGI installer.
- Any electrical installation must be carried out by a qualified electrician/competent person.
- Remove all packaging before using the cooker.
- This cooker must not be connected to a combustion products evacuation device. It shall be installed and connected in accordance with current installation regulations. Particular attention shall be given to the relevant requirements regarding ventilation.
- This cooker is designed to be connected to a 230-240V, 50Hz electrical supply.
- Ensure that the gas and electrical supply complies with the type stated on the rating plate.
- Do not attempt to modify the cooker in any way.

Child Safety

- This cooker is designed to be operated by adults. Do not allow children to play near or with the cooker.
- The cooker gets hot when it is in use. Children should be kept away until it has cooled.
- Children can also injure themselves by pulling pans or pots off the cooker.

During Use

- This cooker is intended for domestic cooking only. It is not designed for commercial or industrial purposes.
- When in use a gas cooker will produce heat and moisture in the room in which it has been installed. Ensure there is a continuous air supply, by keeping air vents in good condition or installing a cooker hood with a venting hose.
- When using the cooker for a long period time, the ventilation should be improved, by opening a window or increasing the extractor speed.
- Do not use this cooker if it is in contact with water. Do not operate the cooker with wet hands.
- The grill pan will become hot during use, always use oven gloves when removing or replacing a hot grill pan.

- During use the appliance becomes hot. Care should be taken to avoid touching heating elements inside the oven.
- Ensure the control knobs are in the 'OFF' position when not in use.
- When using other electrical appliances, ensure the cable does not come into contact with the hot surfaces of the cooker.
- Unstable or misshapen pans should not be used on the hob burners as unstable pans can cause an accident by tipping or spillage.
- Never leave the cooker unattended when cooking with oil and fat.
- Never pull the appliance by the oven handle.
- This cooker should be kept clean at all times. A build-up of fat or foodstuff could result in a fire.
- The oven must be switched off before removing the guard and after cleaning the guard must be replaced in accordance with the manufacturer's instructions.
- Never use steam or high pressure appliances for cleaning the oven.
- Never use plastic dishes in the oven or on the hob burners. Never line any part of the oven with aluminium foil.
- Always ensure that the oven vent, which is located at the centre back of the hob, is left unobstructed to ensure ventilation of the oven cavity.
- Perishable food, plastic items and aerosols may be affected by heat and should not be stored above the cooker.

Service

This cooker should only be repaired or serviced by an authorised Service Engineer and only genuine approved spare parts should be used.

Environmental Information

- After installation, please dispose of the packaging with due regard to safety and the environment.
- When disposing of an old appliance, make it unusable, by cutting off the cable.

Keep this instruction book for future reference and ensure it is passed on to any new owner.

CONTENTS

Instructions for the Installer

Technical features	5
Installation	6
Location	6
Electrical connections	8
Gas connections	9
Conversion of gas	11

Instructions for the User

Use and care	13
Before the first use of the oven	14
Electric oven	15
- Oven function control knob	15
- Thermostat control knob	15
Using the fan oven	16
Grilling	17
Using the hob	18
Maintenance and cleaning	20
Oven bulb replacement	21
Something Not Working	22
Service and spare parts	23
Guarantee Conditions	24

How to read the instruction book

The symbols below will guide you when reading the instruction book



Safety instructions



Step by Step Operation



Advice and recommendations



Environmental Information

INSTRUCTIONS FOR THE INSTALLER

TECHNICAL FEATURES

Dimensions	Height	900 mm
	Width	500 mm
	Depth	600 mm
	Oven Capacity	45 l
Hob	Pan support	Enamelled
	Front right burner	Semi-Rapid 2000 W
	Back right burner	Semi-Rapid 2000 W
	Front left burner	Rapid 3000 W
	Back left burner	Auxiliary 1000 W
	Hob ignition	Integrated
Oven	Grill element	1825 - 1900 W
	Convection fan	35 W
	Circular heating element	1825 - 1900 W
	Oven lamp	Lamp 25W type E14
	Minute minder	
	Cleaning	manual
	Total oven rating	1885 - 1960 W
Supply	Rated voltage	230 - 240 V
	Rated frequency	50 Hz
Accessories	Oven grid	
	Roasting tray / grill pan	
	Trivet	
	2 handles	
	Total cooker rating	1885 - 1960 W

 This appliance complies with:
 European Council Directive **73/23/EEC**
 EMC Directive **89/336/EEC**
 CE Marking Directive **93/68/EEC**

INSTALLATION

! This cooker must be installed in accordance with the IEE Wiring Regulations (Current Edition). Detailed recommendations are contained in the following British Standards Codes Of Practice:
B.S. 6172/ B.S. 5440, Par.2 and B.S. 6891 Current Editions.

The appliance must be installed in accordance with " X " specification (EN60.335-2.6). The cooker must not be installed higher than the worktop.

Please ensure that when the appliance is installed it is easily accessible for the engineer in the event of a breakdown.

Before your appliance is connected to the mains electricity supply, check to ensure that the voltage and the frequency shown on the rating plate corresponds with your supply voltage.

This appliance must be earthed.

! The manufacturer declines any responsibility for possible damages resulting from an installation which doesn't comply with current legislation.

- Installation of flues and ventilation for gas appliances of rated input not exceeding 60 kW (1st, 2nd and 3rd family gases) – Part 2 Specification for installation of ventilation for gas appliances – BS 5440;
 - Gas burning appliances – Part 3 Domestic cooking appliances burning gas – BS 5386;
 - Specification for installation of low pressure gas pipe work of up to 20mm (R1) in domestic premises (2nd family gas) – BS 6891;
 - Pipe threads for tubes and fittings where pressure-tight joints are made on the threads (metric dimensions) – BS 21: 1985;
 - Flexible hoses, end fittings and sockets for gas burning appliances – BS 669;
- Installation of domestic gas cooking appliances (1st, 2nd and 3rd family gases) – BS 6172: 1990;

LOCATION

Remove all the packaging and install the cooker in a dry, ventilated room not near curtains, paper, alcohol, petrol etc (See figure).

! The appliance must be set on a heatproof floor. The adjustable feet must not be removed.

! L.P.G. cookers or ovens **MUST NOT** be installed below ground level, i.e. in a basement, or aboard any boat, yacht or other vessel.

This appliance is approved to class "1" regarding overheating of surrounding surfaces. It is mandatory to keep 20mm distance to the adjacent furniture.

! The cooking appliance must be fitted with a stability chain firmly secured to the wall (see fig).

Ventilation

The room containing the cooker should have an air supply in accordance with B.S. 5440: Part 2: Current Editions.

The following requirements for ventilation must be met.

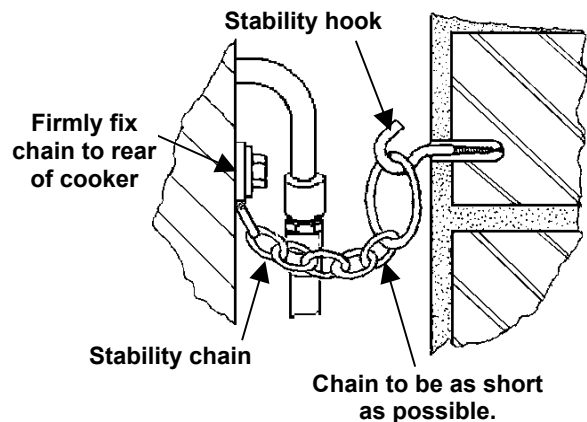
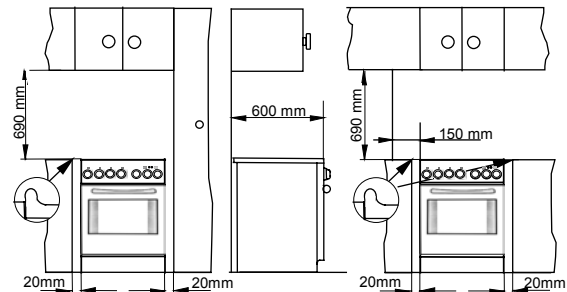

The cooker should not be installed in a bed sitting room with a volume of less than 20m³, if it is installed in a room of volume less 5m³ an air vent of effective area of 110cm² is required; if it is installed in a room of volume between 5m³ and 10m³, an air vent of effective area 50cm² is required, while if the volume exceeds 11m³ no air vent is required. However, if the room has a door, which opens directly to the outside, no air vent is required even when the volume is between 5m³ and 11m³.

If there are other fuel burning appliances in the same room, B.S. 5440: Part. 2: Current Editions should be consulted to determine the requisite air vent requirements.

Location

The cooker may be located in a kitchen, a kitchen/diner or bed sitting room but not in a bathroom, shower room or garage.

For information regarding the fitting of flexible supply pipes, the highest temperature at the rear of this cooker which may come into contact with the supply pipe is 70°C above ambient.

Levelling

The appliance is provided with adjustable small feet placed in the back and front corners of the base.

By adjusting the small feet it is possible to change the height of the appliance so as to ensure a better levelling with other surfaces and an even distribution of the liquids contained in pots and pans.

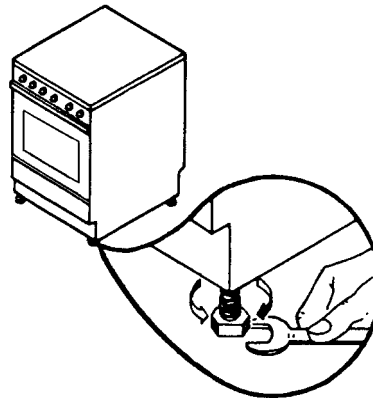

ELECTRICAL CONNECTIONS

! Any electrical work required to install this hob and the supply cable should be carried out by a qualified electrician or competent person, in accordance with the current regulations.

! THIS COOKER MUST BE EARTHED.

! The manufacturer declines any liability should these safety measures not be observed.

! Before any maintenance or cleaning can be carried out, you must **DISCONNECT** the cooker from the electricity supply.

This cooker is designed to be connected to a 230-240V AC, 50Hz electrical supply. Before switching on, make sure the electricity supply voltage is the same as that indicated on the cooker rating plate. The rating plate is located on the oven frame.

The cooker is supplied with a 3 core flexible supply cord incorporating a 13amp plug fitted. In the event of having to change the fuse, a 13amp ASTA approved (BS 1362) fuse must be used. Should the plug need to be replaced for any reason, the wires in the mains lead are coloured in accordance with the following code:

Green and Yellow	- Earth
Blue	- Neutral
Brown	- Live

- Connect the green and yellow (earth) wire to the terminal in the plug which is marked with the letter 'E' or the earth symbol or coloured green and yellow.
- Connect the blue (neutral) wire to the terminal in the plug which is marked with the letter 'N' or coloured black.
- Connect the brown (live) wire to the terminal in the plug which is marked with the letter 'L' or coloured red.

Upon completion there must be no cuts, or stray strands of wire present and the cable clamp must be secure over the outer sheath of the cable.

Fuse capacity: 13A

NOTE: The earth wire should be about 2 cm longer than the live and neutral wires.

Note:

Check on the rating plate the value for the total connection power for establishing the fuse power.

Before connecting check that:

- fuse and household electric installation can carry the load of the appliance (see rating plate);
- The plug used for connection is easily accessible when the appliance is installed.

Important

! If the supply cable is damaged it must be replaced by the manufacturer or its service agent or a similarly qualified person to ensure safety.

! A cut off plug inserted into a 13 amp socket is a serious safety (shock) hazard. Ensure that the cut off plug is disposed of safely.

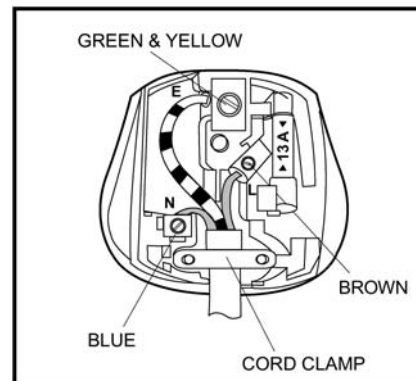

Permanent Connection

The electrical connection should be made using a double pole isolating switch (cooker control switch) with at least 3mm contact separation in all poles. The cable must have conductors of sufficiently high cross-sectional area to prevent overheating or deterioration.

The switch must not break the yellow and green earth cable at any point.

! After installation and connecting, the cable must be placed so that it cannot at any point reach a temperature of more than 50°C above the ambient temperature.

The manufacturer disclaims any responsibility should these safety instructions not be carried out.

GAS CONNECTIONS

Advice for safety

- Before installation ensure that the local distribution conditions (gas type and pressure) and the pre-setting of the appliance are consistent.
- This appliance must be installed only in a room with good ventilation.
- This appliance must not be connected to a chimney. It has to be installed and connected in accordance with the rules in force. Special attention should be paid to the applicable disposal concerning ventilation.
- The adjacent furniture panels have to be heat proof or protected by such material.
- The adjusting conditions of this appliance are mentioned on the rating plate.

Connection to gas supply.

Check that the gas flow and the diameter of the supply pipe is sufficient to supply all the appliances of the installation.

- Check that all connections are tight.
- Install an accessible and visible gas tap to isolate the appliance.

Gas connection

Gas connection must be carried out according to the rules in force.

Your cooker is delivered adjusted for the kind of gas stated on the rating plate.

 **The flexible rubber hose must not be run across the back of the appliance.**

If it is necessary to run the pipework behind the cooker to reach the gas tap, rigid pipework should be used which conforms to current gas regulations.

Rigid Connection

Recommendations when using an appliance flexible connector are as follows:

- For NATURAL the gas installation pipes to the termination point shall comply with:

Specification for installation of low-pressure gas pipe work of up to 20mm (R1) in domestic premises (2nd family gas) – BS 6891;

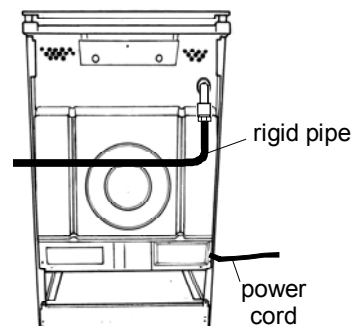
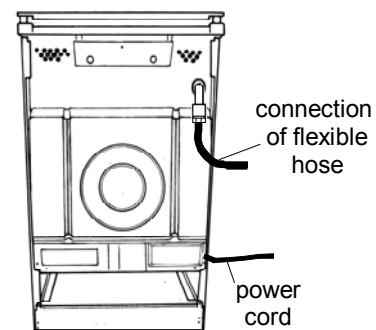

Connection shall be by means of an appliance flexible connector for use with a self-sealing plug-in device, complying with:

Flexible hoses, end fittings and sockets for gas burning appliances – BS 669;

- The appliance flexible connector should not be subjected to undue forces either in normal use or whilst connected or disconnected; The socket which the plug of the appliance flexible connector fits should be permanently attached to a firmly fixed gas installation pipe and positioned such that the appliance flexible connector hose hangs freely downwards (see fig.);
- The appliance flexible connector should be positioned such that it will not suffer mechanical damage, e.g. abrasion from the surrounding kitchen furniture, which may be moved in use such as a drawer or door, or by being trapped by any stability device.

The plug-in-connector bayonet should be accessible for disconnection after moving the appliance.

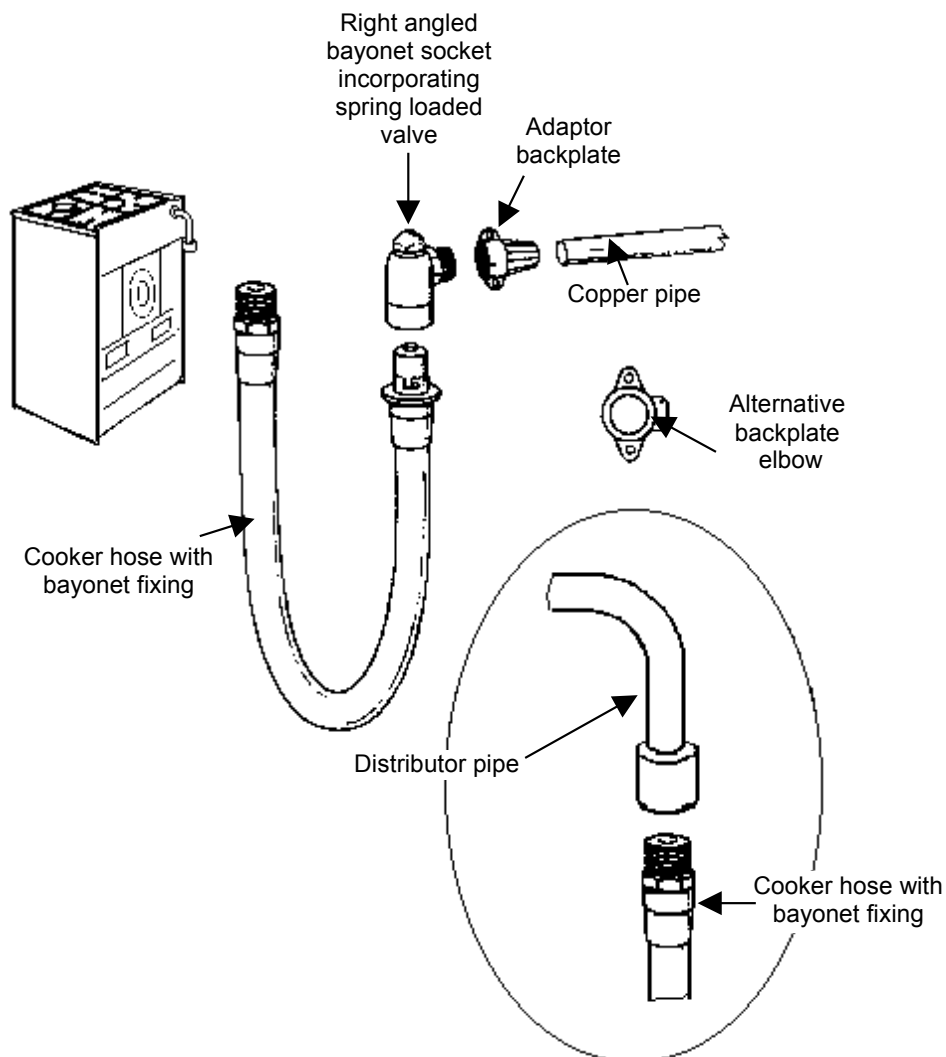

CONVERSION OF GAS

Your cooker is designed to work with natural gas, and is convertible for use with propane or butane.

The LPG conversion kit is available from your Service Force Centre and must be fitted by a Corgi Registered engineer.

For changing the gas type it is necessary to:

- replace the nozzles (hob);
- adjust the minimum level (hob);
- check the gas connection;



Fix the label supplied with the appliance (in the nozzles bag) corresponding to the gas type utilised.

SPECIFICATION NOZZLES

Table no.1
(Cat : II 2H3+)

Burner	Normal power (kW)	Simmer power (kW)	By-pass (mm)	Gas Type	Pressure (mbar)	Nozzle diameter (mm)	Cons	
							m ³ /h	g/h
RAPID	3,00	0,72	0,42	Natural Gas	20	1.19	0,267	-
				Butane	28-30	0,88	-	218,1
				Propane	37	0,88	-	214,2
SEMI-RAPID	2,00	0,43	0,32	Natural Gas	20	0.96	0,190	-
				Butane	28-30	0,71	-	145,4
				Propane	37	0,71	-	142,8
AUXILIARY	1,00	0,35	0,29	Natural Gas	20	0.70	0,095	-
				Butane	28-30	0,50	-	72,7
				Propane	37	0,50	-	71,4

Replace the nozzles of the hob burners

 Before any modifications or conversion to a kind of different gas, you must **DISCONNECT** the cooker from the electricity supply and ensure that all control knobs are in the **OFF** position, and the appliance has cooled completely.

Hob burners

- Remove the pan supports;
- Remove the caps and the burner crowns;
- Using a No 7 socket spanner unscrew the nozzles and replace them with those required for the type of gas in use (see table no. 1).

Reassemble the parts following the same procedure in reverse.

These burners do not need any primary air regulation.

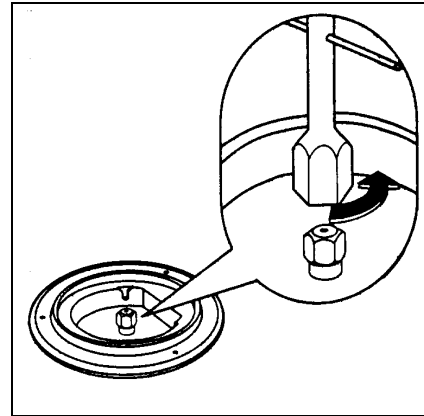

Adjustment of minimum level for the hob burners

The burner is correctly adjusted when the flame is stable silent and goes out without any noise.

When changing the type of gas check that the minimum level is correct. The air admission is correct when the flame is about 4 mm in length.

The top burners do not need adjustment of primary air.

Check that, turning the knob quickly from the maximum position to the minimum one, the flame does not go out.



no air



correct
adjustment



excess of
air

Hob burners

To adjust the minimum level:

- Light the burner
- Turn the knob to the position of the minimum flame;
- Remove the knob;
- Unscrew or screw the by-pass screw (on the right above of tap shaft) until a regular small flame is reached.
- For LPG screw completely the by-pass screw.

Reassemble the parts following the same procedure in reverse.

Check that, when turning the knob quickly from the maximum position to the minimum one, the flame does not go out.

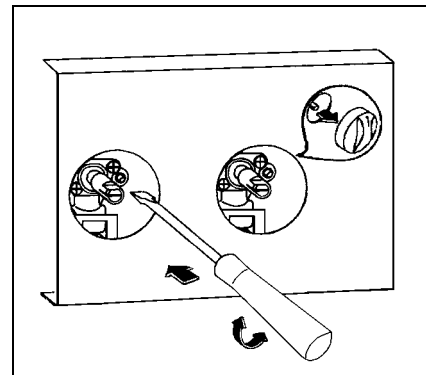

INSTRUCTIONS FOR THE USER

USE AND CARE

Control panel

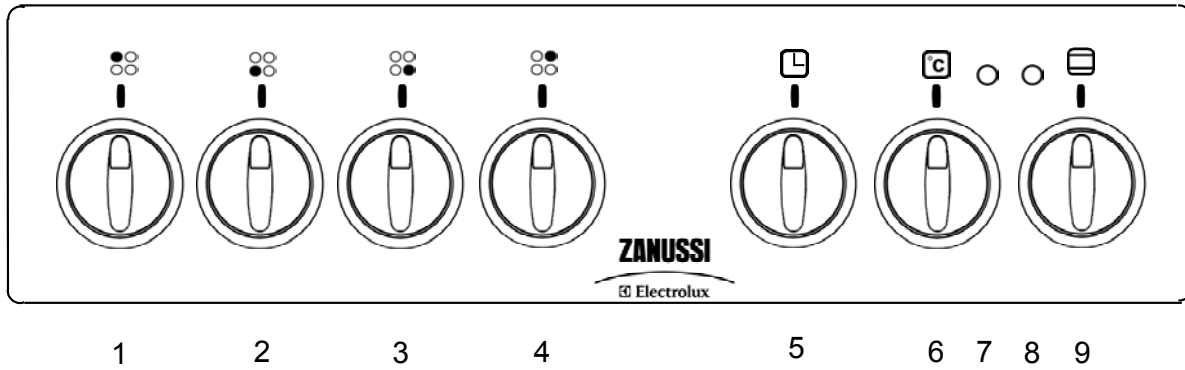

1. Back left burner control knob
2. Front left burner control knob
3. Front right burner control knob
4. Back right burner control knob
5. Minute minder
6. Oven thermostat
7. Oven thermostat pilot light
8. Main pilot light
9. Oven function control knob (selector)

Hob

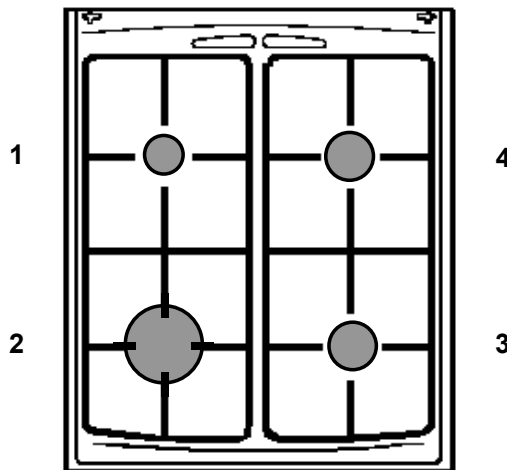

1. Back left burner (auxiliary)
2. Front left burner (rapid)
3. Front right burner (semi-rapid)
4. Back right burner (semi-rapid)

USE OF APPLIANCE

Before the First Use of the Oven



Before the first use ensure that the room is well ventilated: V.M.C. (Mechanic ventilation) or opened window.



Remove all packaging, both inside and outside the oven, before using the oven.

Before first use, the oven should be heated without food. During this time, an unpleasant odour may be emitted. This is quite normal.

1. Remove the oven accessories.
2. Remove any adhesive labels or protective films, if there are any.
3. Heat the oven at the maximum temperature for about 45 min.

This procedure should be repeated with the grill function for approximately 5-10 minutes.

Clean the accessories with a soft detergent. Rinse and dry carefully.

Rating Plate

The model number of your cooker can be found on the rating plate on the lower front frame of the cooker upon opening the door.

The cooker must be protected by a suitably rated fuse or circuit breaker. The rating of the cooker is given on the rating plate.

About condensation and steam

When food is heated it produces steam in the same way as a boiling kettle. The oven vents allow some of this steam to escape. However, **always stand back from the oven when opening the oven door** to allow any build up of steam or heat to release.

If the steam comes into contact with a cool surface on the outside of the oven, e.g. a trim, it will condense and produce water droplets. This is quite normal and is not a fault with the oven.

To prevent discolouration, regularly wipe away condensation and also soilage from surfaces.

Cookware

Use any ovenproof cookware, which will withstand temperatures of 250°C.

Oven dishes, etc. should not be placed directly on the oven base.



During cooking in the oven the oven door is hot. Take care that children do not play near it.

ELECTRIC OVEN

Oven Function Control Knob

0 Oven switched off

 Oven light

 Defrost – (NB: This is NOT a cooking position). This position is intended to assist in thawing of frozen foods.

 Fan cooking – Thermaflow cooking; this system will allow you to roast and bake at the same time with very little flavour transference, and on any shelf.

 Grill - The grill cannot be used at the same time as the oven. **The oven door must be closed when grilling.**

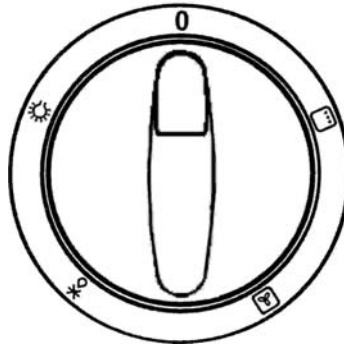

Caution

Do not place pans, dripping pans, baking trays or aluminium foil directly on the base of the oven. This could cause a heat build-up which could affect the performance of the oven and damage the oven enamel.

Thermostat Control Knob

By turning the oven control knob clockwise, you select the cooking temperature.

The temperatures shown here are on the actual control knob.

Temperature selection starts at 50°C and will reach approximately 250°C at the centre of the oven.

The thermostat controlling the temperature is variable so it is possible to select temperatures between those marked.

The maximum setting is particularly suitable for grilling.

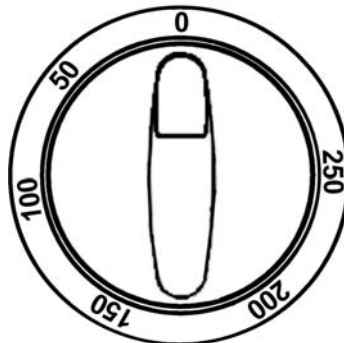

Things to note

- Once the oven temperature has been selected, the oven thermostat pilot light will come on and remain on until the oven has reached the correct setting; after that, it will go on and off with the thermostat, showing how the temperature is being maintained.

USING THE FAN OVEN

The Fan Oven

The air inside the oven is heated by the element around the fan situated behind the back panel. The fan circulates hot air to maintain an even temperature inside the oven.

The advantages of cooking with this function are:

Faster Preheating

Because the fan oven quickly reaches temperature, it is not usually necessary to preheat the oven although you may find that you need to allow an extra 5-7 minutes on cooking times. For recipes, which require higher temperatures, best results are achieved if the oven is preheated first, e.g. bread, pastries, scones, souffles, etc.

Lower Temperatures

Fan oven cooking generally requires lower temperatures than conventional cooking.

Remember to reduce temperatures by about 20- 25°C for your own recipes, which use conventional cooking.

Even Heating for Baking

The fan oven has uniform heating on all runner positions. This means that batches of the same food can be cooked in the oven at the same time. However, the top shelf may brown slightly quicker than the lower one.

This is quite usual. There is no mixing of flavours between dishes .

How to Use the Fan Oven

1. Turn the oven function control knob to 
2. Turn the thermostat control knob to the required temperature.

HINTS AND TIPS

Shelf positions are not critical, but make sure the shelves are evenly spread.

When cooking more than one dish in the fan oven, place dishes centrally on the shelves rather than several dishes on one shelf.

When the oven is full, you may need to allow slightly longer cooking times.

A shelf may be placed on the floor of the oven. Place dishes on a shelf in this position rather than on the oven base, to allow air circulation around the food.

When the oven is full of the same food, e.g. equal trays of small cakes or equal size victoria sandwich cakes, then they will be cooked in the same time and removed from the oven together. When different sizes of trays or types of food, e.g. biscuits and cakes are cooked, they will not necessarily be ready together.

The fan oven can be used to heat foods through without thawing first, e.g. fruit tarts, mince pies, sausage rolls, and other small pastry items. Use a temperature of 190-200°C and allow 20-40 minutes (depending on the quantity of food in the oven).

Only experience will enable you to determine the correct settings for your personal cooking needs. The temperatures are intended as a guide only. It may be necessary to increase or decrease the temperature to suit your individual requirements.

The effects of dishes on cooking results

Dishes and tins vary in their thickness, conductivity, colour, etc. which affects the way they transmit heat to the food inside them:

A Aluminium, earthenware, oven glassware and bright shiny utensils reduce cooking and base browning.

B Enamelled cast iron, anodized aluminium, aluminium with non-stick interior and coloured exterior and dark, heavy utensils increase cooking and base browning.

Defrosting

The defrosting function allows you to defrost frozen foods. The oven fan operates without heat and circulates the air, at room temperature, inside the oven. This increases the rate at which defrosting takes place.

This function is particularly suitable for delicate food which could be damaged by heat, e.g. cream filled gateaux, iced cakes, pastries, bread and other yeast products.

HINTS AND TIPS

- Cover food with a lid, aluminium foil or plastic film to prevent drying out during defrosting.
- Small or thin pieces of fish fillet or peeled prawns, mince, liver and thin chops will defrost in 1-2 hours. Ensure that they are cooked or refrigerated immediately after defrosting to maintain good food hygiene.
- Place the frozen food a single layer where possible, and turn it over half way through the defrosting process.
- DO NOT leave food at room temperature once it is defrosted. Cook raw food immediately or store cooked food in the fridge.
- Take care to follow the basic rules for hygiene when handling fresh, frozen, raw and cooked foods.

Main pilot light

This light will come on when the oven function control knob is set.

Grilling

 **When grilling, the accessible parts of the appliance are hot and the appliance should not be left unattended. Take care that children do not play near it. During use the appliance becomes hot. Care should be taken to avoid touching heating elements inside the oven.**

 **The grill pan will become hot during use, always use oven gloves when removing or replacing a hot grill pan, or the grill pan handles if provided.**

 **All grilling must be carried out with the oven door closed .**

 To switch on the grill, turn the oven function control knob to GRILL, then turn the thermostat knob to the maximum temperature .

Most foods should be placed on the grid in the grill pan to allow maximum circulation of air to lift the food out of the fats and juices. Food such as fish, liver and kidneys may be placed directly on the grill pan, if preferred.

Adjust the grid and grill pan runner position to allow for different thicknesses of food.

Food should be thoroughly dried before grilling to minimise splashing. Brush lean meats and fish lightly with a little oil or melted butter to keep them moist during cooking.

Accompaniments such as tomatoes and mushrooms may be placed underneath the grid when grilling meats.

When toasting bread, we suggest that the top runner position is used with the grid in its 'high' position.

Preheat the grill for a few minutes before sealing steaks or toasting. Adjust the shelf position as necessary, during cooking.

The food should be turned over during cooking, as required.

NOTE: For safety in use, the grill element is controlled by the thermostat. During cooking, the grill cycles on and off to prevent overheating.

Cooking time depends on the thickness of the meat and not on its weight.

Oven light

The oven is equipped with a lamp. It starts operating when the oven function control knob is turned to .

Timer (Minute Minder)

Turn the control knob clockwise to the maximum position and then turn it back to the position corresponding to the period of time necessary for the cooking.

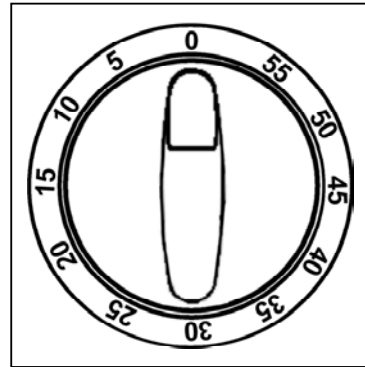

At the end of the time selected an acoustic signal sounds which stops automatically. The timer does not interrupt the operation of the oven at the end of the set time.



Using the Hob

The Hob Burners

The symbol on the control panel shows which burner is operated by the knob. (See control panel).

- Off
-  Maximum level
-  Minimum level

Use the maximum level for boiling and the minimum for simmering.

Always choose positions between the minimum and maximum, never between maximum and off.

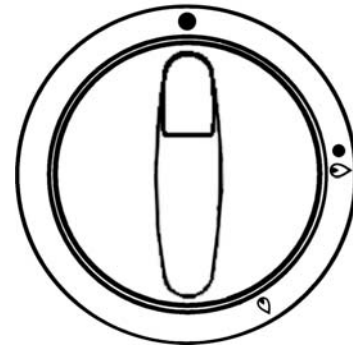

Ignition of the burners

- Push the knob and turn it left to the “large flame” symbol.
- At the same time the spark generator begin to produce a spark.
- Release the knob and check that the burner has ignited.
- Upon ignition, adjust the flame as required.

OR

Power Cut

- Push the corresponding knob in completely and turn it left to the “large flame” symbol and ignite with a match.
- Release the knob and check that the burner has ignited.
- Upon ignition, adjust the flame as required.

If for any reason the flame should extinguish turn off the relevant control knob, leave for at least one minute and then re-ignite.

If after a few attempts the burner does not ignite, check that the burner ring and its cap are correctly positioned.

Turning off the burners

Turn the control knob clockwise to mark « ● ».

 **Do not put anything on the hob that is liable to melt.**

Selecting the Correct burner

Above every knob there is a symbol for the corresponding burner.

For good cooking results, always choose pans, which correctly fit to the diameter of the burner used (see figs). Choose thick, flat bottom pots.

We recommend the flame is lowered as soon as the liquid starts boiling.

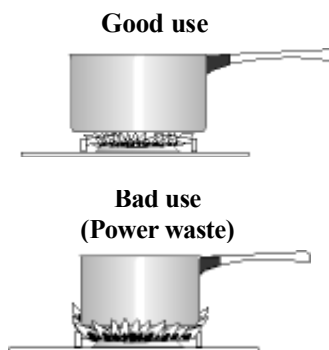

For a correct ignition always keep the burner ring and the spark plugs clean.

The following diameter pans can be used:

Burner	Power (kW)	Diameter (mm)	
		min.	max.
Rapid	3,00	160	280
Semi-Rapid	2,00	140	240
Auxiliary	1,00	120	180

Accessories delivered with the appliance

The following accessories are supplied with your appliance.

- Shelf for placing dishes on .
The dish should be put in the middle of the shelf to balance the weight.
- A roasting tray with roasting grid on it.
It is used to collect juice when cooking in it, place it on the shelf 2.
If you do not use the roasting tray, remove it from the oven.
- Removable handles

In addition to the accessories supplied we recommend you only use heatproof dishes/pans (according to the manufacturer's instructions).

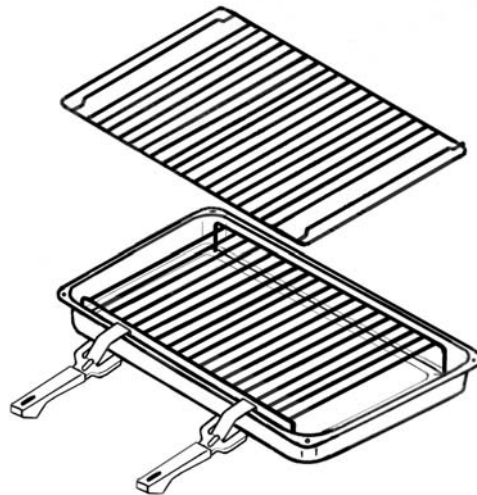

Removable drawer

The removable drawer is located underneath the oven cavity.

 **During cooking the drawer may become hot if the oven is in use for a long period of time. Flammable materials such as oven gloves, tea towels, plastic aprons etc. should not be stored in the drawer.**

Oven accessories such as baking sheets, will also become hot, therefore care should be taken when removing these items from the drawer whilst the oven is in use or still hot.



To open

- Grasp the drawer from underneath and pull it out as shown.
- To remove the drawer, pull it out to the stop, then lift it up slowly and pull it out completely.

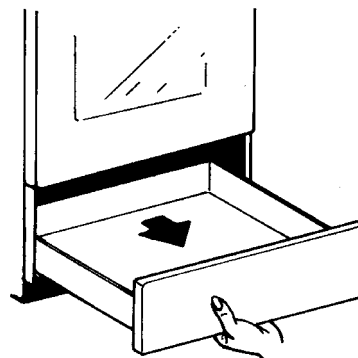
To replace the drawer follow the same procedure in reverse.



MAINTENANCE AND CLEANING

-  **The oven should be kept clean at all times. A build-up of fats or other foodstuffs could result in a fire.**
-  **Before cleaning, ensure all control knobs are in the OFF position, and the appliance has cooled completely.**
-  **Before any maintenance or cleaning can be carried out, you must DISCONNECT the cooker from the electricity supply.**

Cleaning materials

Before using any cleaning materials on your oven, check that they are suitable and that their use is recommended by the manufacturer.

-  **Cleaners that contain bleach should NOT be used as they may dull the surface finishes. A steam cleaner is not to be used. Harsh abrasives should also be avoided.**

External cleaning

In the case of stainless steel parts, you may use commercially available stainless steel cleaners with care. These also provide a protective film against finger marks.

-  **To prevent damaging or weakening the door glass panels avoid the use of the following:**

- Household detergent and bleaches
- Impregnated pads unsuitable for non stick saucepans
- Brillo/Ajax pads or steel wool pads
- Chemical oven pads or aerosols
- Rust removers
- Bath/Sink stain removers

Oven Cavity

The enamelled oven cavity is best cleaned whilst the oven is still warm.

Wipe the oven over with a soft cloth soaked in warm soapy water after each use. From time to time it will be necessary to do a more thorough cleaning, using a proprietary oven cleaner.

Oven Shelves and shelf support

To clean the oven shelves, and shelf support soak in warm soapy water and remove stubborn marks with a well wetted soap impregnated pad. Rinse well and dry with a soft cloth.

Grease Filter

When cooking meat, the grease filter must be fitted over the oven fan by clipping it over the vents in the back panel. This will prevent a build up of fat on the fan impeller.

Do not use abrasive materials to clean the seal. The grease filter is dishwasher proof. When cooking is completed and the oven has cooled down, remove the filter by pushing the protruding tongue on the filter upward.

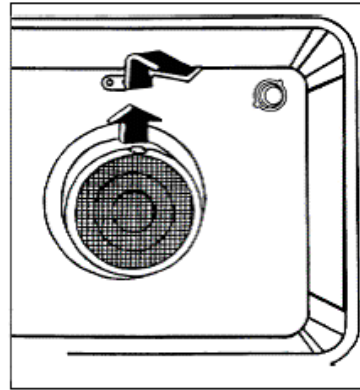

Cleaning the Oven door

For a more complete cleaning of the oven door, it is advisable to remove it in the following way:

- Open the door completely.
- Turn the two locking plates on the hinge arms to 170°;
- Partially close the door, to a 30° angle;
- Lift the door and pull out.

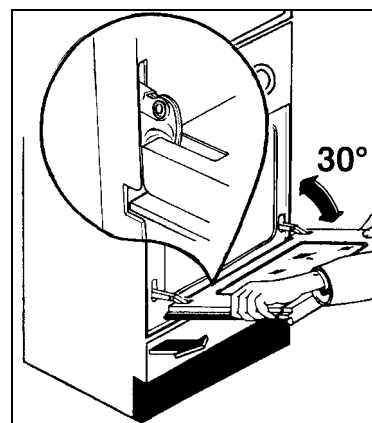
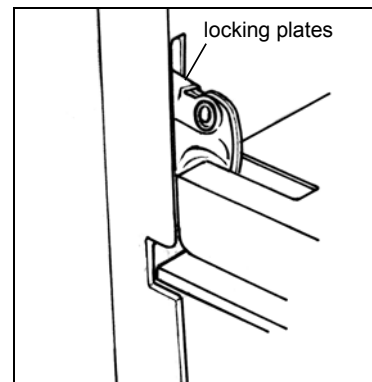

Refit the door by reversing the operation described above.

! **DO NOT clean the oven door while the glass panels are warm. If this precaution is not observed the glass panel may shatter. If the door glass panel becomes chipped or has deep scratches, the glass will be weakened and must be replaced to prevent the possibility of the panel shattering. Contact your local Service Centre who will be pleased to advise further.**

Hob

After every use wipe with a soft cloth well wrung out in warm water to which a little washing up liquid has been added, avoiding any leakage through the holes of the hob. Rinse and dry with a soft cloth.

To remove more stubborn stains, wet and leave to dissolve, do not scratch and avoid the use of abrasive or caustic products that could damage the enamel.

Burners

The burner caps and crowns can be removed for cleaning. Wash the burner caps and crowns using hot soapy water, and remove marks with a mild paste cleaner. A well-moistened soap impregnated steel wool pad can be used with caution, if the marks are particularly difficult to remove.

After cleaning, be sure to wipe dry with a soft cloth.

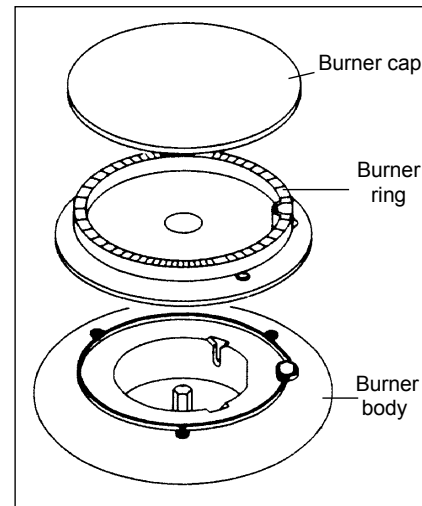

OVEN BULB REPLACEMENT

! **Ensure that the appliance is switched off and disconnected from the electricity supply before replacing the bulb to avoid possibility of an electric shock.**

If the oven bulb needs replacing, it must comply with the following specifications:

Wattage:	25W
Voltage:	230/240V(50Hz)
Temperatures:	300°C
Thread Type:	E14

👉 To replace the faulty bulb.

1. Turn the glass cover anticlockwise and remove.
2. Remove the faulty bulb and replace with a new one.
3. Refit the glass cover.

Reconnect the appliance to the electricity supply.

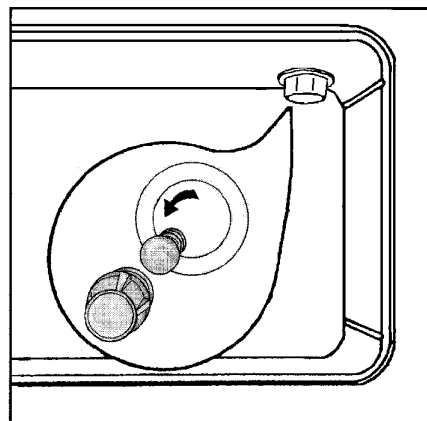

SOMETHING NOT WORKING

If the appliance is not working correctly, please carry out the following checks, before contacting your local Service Force Centre.

IMPORTANT: If you call out an engineer to a fault listed below, or to repair a fault caused by incorrect use or installation, a charge will be made even if the appliance is under guarantee.

Symptoms	Solutions
The flow of gas seems abnormal	Check that: <ul style="list-style-type: none"> • The flame spreader holes are not obstructed • The pressure regulator is working • The bottle valve is completely open
No burner ignition	Check that: <ul style="list-style-type: none"> • Gas supply is completely open • The position of gas pipe is correct • The burner is not wet • The burner cap and ring burner have been replaced correctly after cleaning
The gas ring burns unevenly	Check that: <ul style="list-style-type: none"> • The main jet is not blocked and the ring burner is clean of food particles • The burner cap and ring burner have been replaced correctly after cleaning
The oven does not come on	Check: <ul style="list-style-type: none"> - check if a cooking function/temperature has been selected correctly - the socket switch or the switch from the mains supply to the cooker are ON.
It takes too long to finish the dishes, or they are cooked too fast	Check: <ul style="list-style-type: none"> - the temperature may need adjusting
The oven lamp does not work	<ul style="list-style-type: none"> - The lamp has burnt out. To replace it follow the instructions given in the relevant paragraph.

If after these checks, the appliance still does not operate correctly, contact your local Service Force Centre. When you contact the Service Force Centre you will need to give the following details:

1. Your name, address and post code.
2. Your telephone number
3. Clear and concise details of the fault
4. The model and serial number of the appliance (found on the rating plate*)
5. The purchase date

* The rating plate can be found on the lower left hand corner of the front frame of the cavity.

Please note that a valid purchase receipt or guarantee documentation is required for in-guarantee service calls.

SERVICE AND SPARE PARTS



In the event of your appliance requiring service, or if you wish to purchase spare parts, please contact your local Service Force Centre by telephoning:-

08705 929929

Your telephone call will be automatically routed to the Service Force Centre covering your post code area.

For the address of your local Service Force Centre and further information about Service Force, please visit the website at www.serviceforce.co.uk

In-guarantee customers should ensure that the checks under the heading “Something Not Working” have been made as the engineer will make a charge if the fault is not a mechanical or electrical breakdown. Please note that it will be necessary to provide proof of purchase for any in-guarantee service calls.

CUSTOMER CARE

For general enquiries concerning your Zanussi Electrolux appliance and or for further information on our products, contact our Customer Care Department by letter or telephone at the address below:

Customer Care Department
Zanussi Electrolux
55-77 High Street
Slough
Berkshire SL1 1DZ

Tel: 08705 727727 (*)

(*) calls to this number may be recorded for training purposes.

GUARANTEE CONDITIONS

Standard Guarantee Conditions

We Zanussi Electrolux undertake that if, within 12 months of the date of the purchase, this Zanussi Electrolux appliance or any part thereof is proved to be defective by any reason only of faulty workmanship or materials, we will, at our option, repair or replace the same FREE OF ANY CHARGE for labour, materials or carriage on condition that:

- The appliance has been correctly installed and used only on the electricity supply stated on the rating plate.
- The appliance has been used for normal domestic purposes only, and in accordance with the manufacturer's instructions.
- The appliance has not been serviced maintained, repaired, taken apart or tampered with by any person not authorised by us.
- All service work under this guarantee must be undertaken by a Zanussi Electrolux Service Force Centre.
- Any appliance or defective part replaced shall become the Company's property.
- This guarantee is in addition to your statutory and other legal rights.

Home visits are made between **8.30am and 5.30pm** Monday to Friday. Visits may be available outside these hours, in which case a **premium** will be charged.

Exclusions

This guarantee does not cover:

- Damage or calls resulting from transportation, improper use or neglect, the replacement of any light bulbs or removable parts of glass or plastic.
- Costs incurred for calls to put right an appliance which is improperly installed or calls to appliance outside the United Kingdom.
- Appliances found to be in use within a commercial or similar environment, plus those, which are the subject to rental agreements.

Products of Zanussi Electrolux manufacture which are not marketed by Zanussi Electrolux.

European Guarantee

If you should move to another country within Europe then your guarantee moves with you to your new home subject to the following qualifications:

- The guarantee starts from the date you first purchased your product.
- The guarantee is for the same period and to the same extent for labour and parts as exist in the new country of use for this brand or range of products.
- This guarantee relates to you and cannot be transferred to another user.
- Your new home is within the European Community (EC) or European Free Trade Area.
- The product is installed and used in accordance with our instructions and is only used domestically, i.e. a normal household
- The electrical supply complies with the specification given in the rating label.
- The product is installed taking into account regulations in your new country.

Before you move, please contact your nearest Customer Care Centre, listed below, to give them details of your new home. They will then ensure that the local Service Organisation is aware of your move and able to look after you and your appliances.

France	Senlis	+33 (0) 3 44 62 20 13
Germany	Nürnberg	+49 (0) 800 234 7378
Italy	Pordenone	+39 (0) 800117511
Sweden	Stockholm	+46 (0) 20 78 77 50
UK	Slough	+44 (0) 1753 219897

ZCM 531 - 342737962

© Electrolux plc 2003

 **From the Electrolux Group.** *The world's No.1 choice*

The Electrolux Group is the world's largest producer of powered appliances for kitchen, cleaning and outdoor use. More than 55 million Electrolux Group products (such as refrigerators, washing machines, vacuum cleaners, chain saws and lawn mowers) are sold each year to a value of approx. USD 14 billion in more than 150 countries around the world.

Download from www.5mmanuals.com. All Manuals Search And Download.

Free Manuals Download Website

<http://myh66.com>

<http://usermanuals.us>

<http://www.somanuals.com>

<http://www.4manuals.cc>

<http://www.manual-lib.com>

<http://www.404manual.com>

<http://www.luxmanual.com>

<http://aubethermostatmanual.com>

Golf course search by state

<http://golfingnear.com>

Email search by domain

<http://emailbydomain.com>

Auto manuals search

<http://auto.somanuals.com>

TV manuals search

<http://tv.somanuals.com>