

# ZANUSSI

 Electrolux

## MIXED FUEL COOKERS

ZCM 650

ZCM 651

INSTRUCTION BOOKLET

Please read this instruction booklet before using the appliance





# Important Safety Information



You **MUST** read these warnings carefully before installing or using the hob. If you need assistance, contact our Customer Care Department on 08705 727727

## Installation

- Appliances in the UK must be installed and serviced by a competent person as stated in the Gas Safety(Installation and Use) Regulations Current Editions and the IEE Wiring Regulations.
- For appliances installed in the Republic of Ireland please refer to NSAI-Domestic Gas Installations I.S.813 Current Editions and the ETCI Rules for Electrical Installations.
- This cooker is heavy. Take care when moving it.
- Remove all packaging before using the cooker.
- Some parts have a shock-resistant plastic film protection. Be sure to remove this plastic film before you start operating the appliance and clean the parts involved using a soft cloth wrung out in warm water to which a little washing up liquid has been added.
- Ensure that the gas and electrical supply complies with the type stated on the rating plate, located near the gas supply pipe.
- Do not attempt to modify the cooker in any way.

## Child Safety

- This cooker is designed to be operated by adults. Do not allow children to play near or with the cooker.
- The cooker gets hot when it is in use. Children should be kept away until it has cooled.
- Children can also injure themselves by pulling pans or pots off the cooker.

## During Use

- This cooker is intended for domestic cooking only. It is not designed for commercial or industrial purposes.
- When in use a gas cooker will produce heat and moisture in the room in which it has been installed. Ensure there is a continuous air supply, keeping air vents in good condition or installing a cooker hood with a venting hose.
- When using the cooker for a long period of time, the ventilation should be improved, by opening a window or increasing the extractor speed.
- Do not use this cooker if it is in contact with water. Do not operate the cooker with wet hands.
- Ensure the control knobs are in the 'OFF' position when not in use.
- During use the appliance becomes hot. Care should be taken to avoid touching heating elements inside the oven.
- When using other electrical appliances, ensure the

cable does not come into contact with the hot surfaces of the cooker.

- Unstable or misshapen pans should not be used on the hob burners as unstable pans can cause an accident by tipping or spillage.
- Never leave the cooker unattended when cooking with oil and fats.
- This cooker should be kept clean at all times. A build-up of fats or foodstuffs could result in a fire.
- Never use plastic dishes in the oven or on the hob burners. Never line any part of the oven with aluminium foil.
- Always ensure that the oven vent which is located at the centre back of the hob is left unobstructed to ensure ventilation of the oven cavity.
- Perishable food, plastic items and aerosols may be affected by heat and should not be stored above the cooker.

## Service

- This cooker should only be repaired or serviced by an authorised Service Engineer and only genuine approved spare parts should be used.

## Environmental Information

- After installation, please dispose of the packaging with due regard to safety and the environment.
- When disposing of an old appliance, make it unusable, by cutting off the cable.

**Keep this instruction book for future reference and ensure it is passed on to any new owner.**

 This appliance is manufactured according to the following EEC directives:  
73/23 EEC - 90/683 EEC - 93/68 EEC -  
89/336 EEC - 90/396 EEC,  
current edition.

**These instructions are only valid in the countries whose symbols appear on this booklet's cover.**

# Contents

## For the User

Important Safety Information	3
Control Panel	5
The Gas Hob Controls	6
Electric Oven	7
Electric Programmer	8
Before the First Use of the Cooker	10
Programming the Oven	11
Safety and Energy saving functions	14
Using the Oven	15
Hints and Tips	15
Using the Conventional Oven	16
Cooking Chart - Conventional Oven	17
Pizza Oven	18
Grilling	19
Defrosting	20
Maintenance and Cleaning	21
Cleaning the Oven	22
Something not working	27
Service and Spare Parts	28
Customer Care Department	28
Guarantee Conditions	29

## For the Installer

Instructions for the Installer	30
Important Safety Requirements	30
Installation	31
Electrical Connections	33
Commissioning	34
Conversion from Natural Gas to LPG	34

## Guide to Use the Instructions

The following symbols will be found in the text to guide you throughout the Instructions:



Safety Instructions



Step by step instructions for an operation



Hints and Tips



Environmental Information

# Control Panel

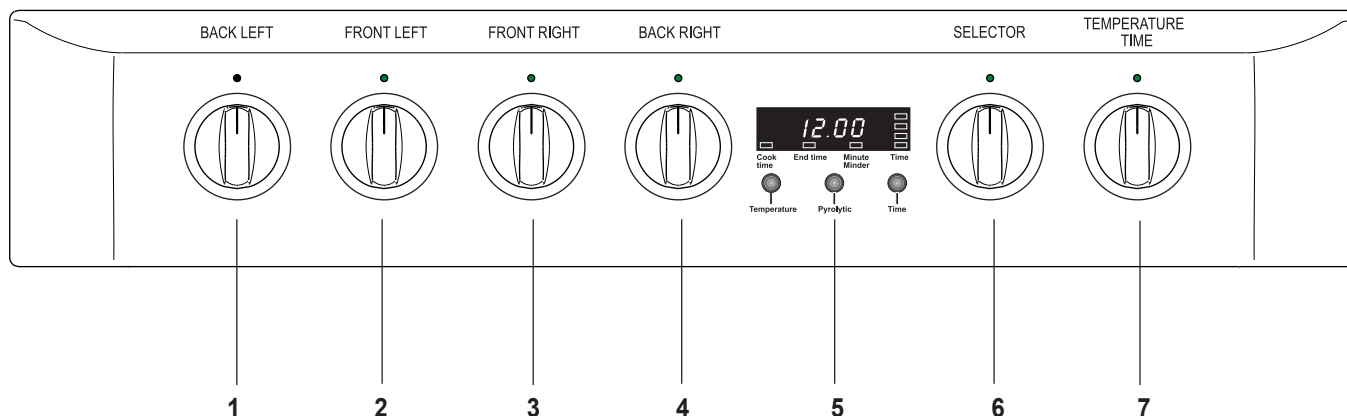

1. Back left burner control knob (semi-rapid)
2. Front left burner control knob (ultra-rapid triple crown)
3. Front right burner control knob (auxiliary)
4. Back right burner control knob (semi-rapid)
5. Electronic Programmer
6. Oven function control knob
7. Time/Temperature control knob

# The Oven Cavity

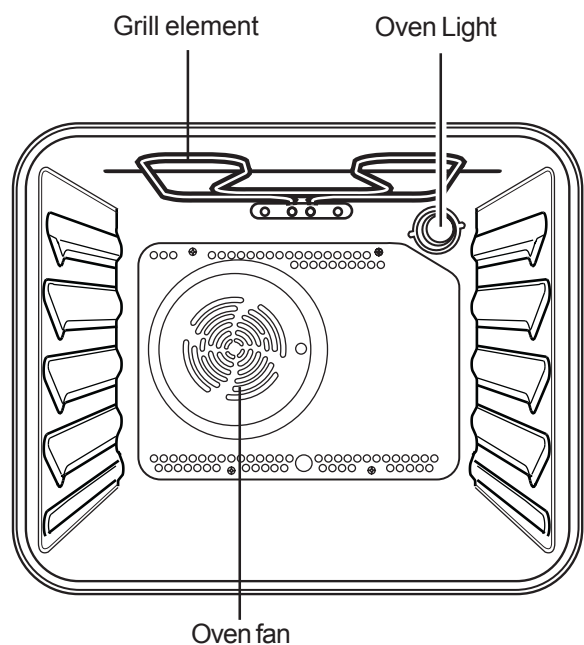

## Accessories

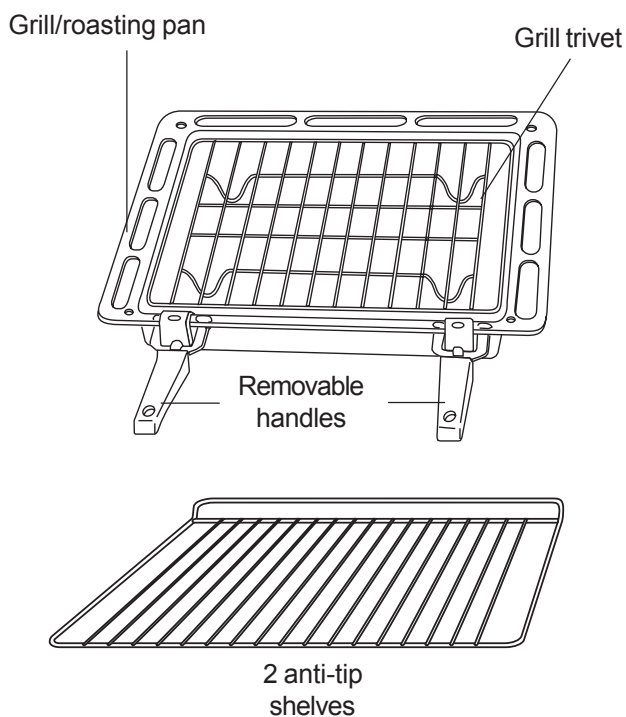

# The Gas Hob Controls

☞ To light a burner:

- turn the relevant control knob anticlockwise to the maximum position, then push it down to ignite the burner;
- upon ignition, keep the knob pushed down about 5 seconds. This will allow the "thermocouple" (see diagram, D) to be heated and the safety device to be switched off, otherwise the gas supply would be interrupted.
- then, check the flame is regular and adjust it as required.

If you cannot light the flame even after several attempts, check the "cap" and "crown" (see diagram, A-B) are in the correct position.

To put the flame out, turn the knob to the symbol ●.

**i** When switching on the mains, after installation or a power cut, it is quite normal for the spark generator to be activated automatically.

**!** If you use a saucepan which is smaller than the recommended size, the flame will spread beyond the bottom of the pan, causing the handle to overheat.

**!** As soon as a liquid starts boiling, turn down the flame so that it will barely keep the liquid simmering.

**!** Take care when frying food in hot oil or fat, as the overheated splashes could easily ignite.

**i** If the control knobs become difficult to turn, please contact your local Service Force Centre.

To ensure maximum burner efficiency, you should only use pots and pans with a flat bottom fitting the size of the burner used (see table).

Burner	minimum diameter	maximum diameter
Large (ultra rapid triple crown)	180 mm	260 mm
Medium (semi-rapid)	120 mm	220 mm
Small (auxiliary)	80 mm	160 mm

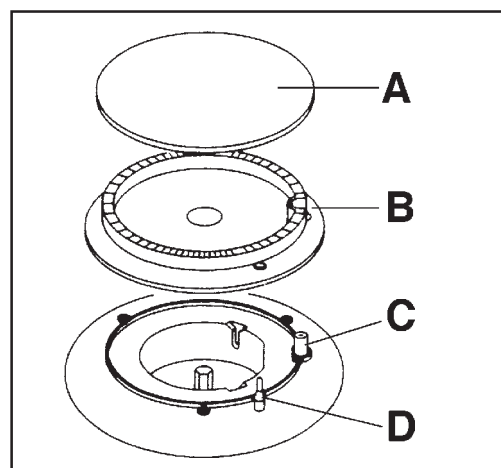
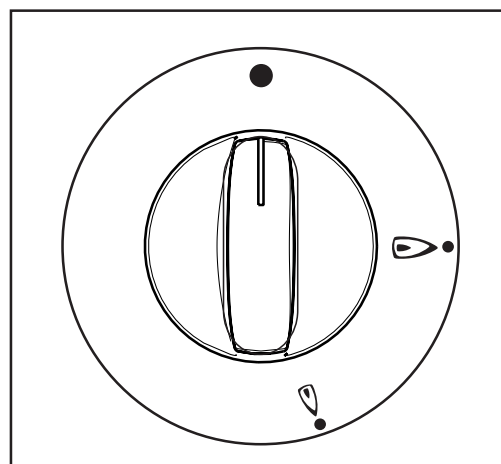



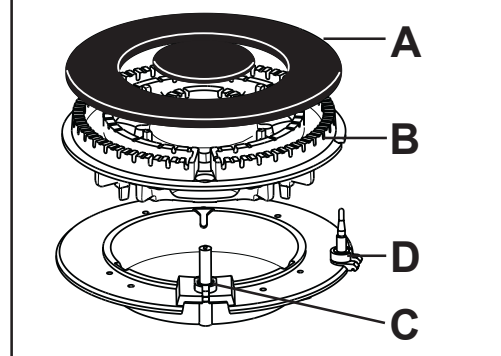



**Triple-crown Burner**



- A - Burner cap
- B - Burner crown
- C - Ignition electrode
- D - Thermocouple

# Electric Oven

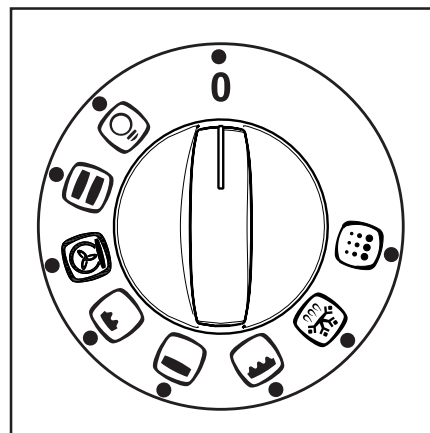

## Oven Function Control Knob

-  **Oven Light** - The oven light will be on without any cooking function.
-  **Conventional cooking** - The heat comes from both the top and bottom element, ensuring even heating inside the oven. Pre-set temperature: 200 °C
-  **Pizza Oven** - The bottom element provides direct heat to the base of pizzas, quiches or pies, while the fan ensures air is circulated to cook the pizza toppings or pie fillings. Pre-set temperature: 175 °C
-  **Inner Grill** - It can be used for grilling small quantities. Pre-set temperature: 250 °C
-  **Top heating element** - The heat comes from the top of the oven only. Pre-set temperature: 250 °C
-  **Full Grill** - The full grill element will be on. Pre-set temperature: 250 °C
- Defrost setting** - This function assists in thawing of frozen food. Pre-set temperature: 30 °C
-  **Pyrolytic cleaning** - This special function allows you to clean thoroughly the oven cavity.



## Time/Temperature Control knob

The time/temperature control knob allows you to select the time (minute minder, cooking duration and end of cooking time) and temperature.

Turn it clockwise  and hold it in the turned position to increase the time/temperature setting. Turn it anticlockwise  and hold it in the turned position to decrease the time/temperature setting. The count-up or count-down speed increases the longer the knob is held in the turned position.

## Cooling fan

The cooling fan operates during cooking. Air is expelled through vents between the oven door and the control panel, as shown in the diagram. The cooling fan may run on after the oven is switched off to keep the controls cool. This is quite normal.

## The Safety Thermostat

This oven is provided with a safety thermostat. In case of malfunctioning of the main thermostat, and consequent over-heating, the safety device will stop the power supply to the appliance. If this happens, call your local Service Force Centre. Under no circumstances should you attempt to repair the appliance yourself.

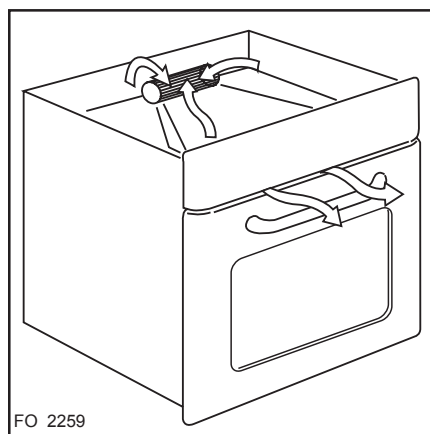
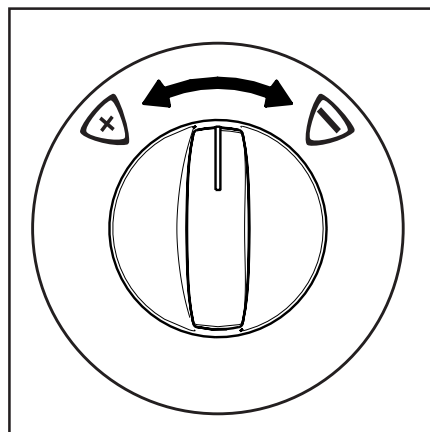

FO 2259

# Electronic programmer

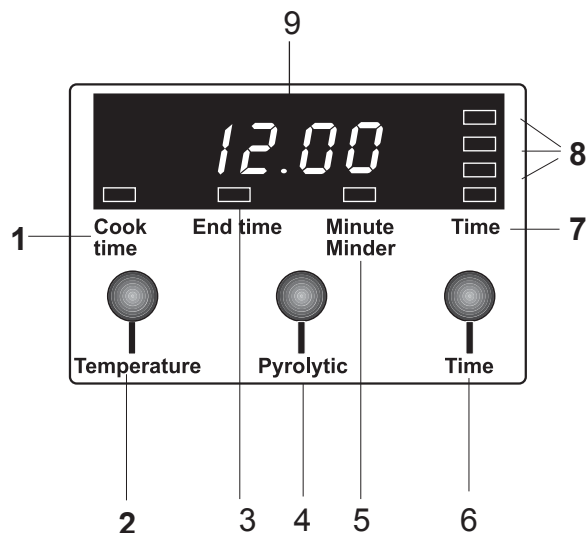

1. "Cook time" indicator
2. "Temperature" button for displaying the temperature inside the oven
3. "End Time" indicator
4. "Pyrolytic" button for activating the pyrolytic cleaning cycle
5. "Minute minder" indicator
6. "Time" button for selecting the time functions
7. "Time" indicator
8. Temperature level indicators
9. Display

**i** The oven will work only if the time of day has been set. However, the oven can also be operated without any programme.

**i** In case of loss of power, all the settings (time of day, set programme or programme in operation), will be cancelled. When the power is restored, the numbers on the display will flash, and the timer has to be reset.



## How to set the time of day

When the power supply is switched on, or after a power failure, the display will automatically show 12.00 and the indicator "Time" will flash in the display.

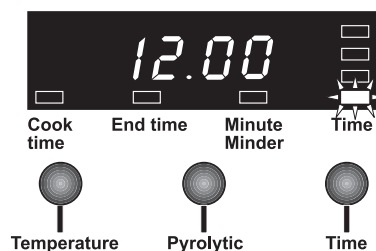
Ensure the correct time of day is set before using the oven.



### To set the correct time of day:

1. Turn the Time/Temperature control knob to  or  to adjust the time in 1 minute degree step.

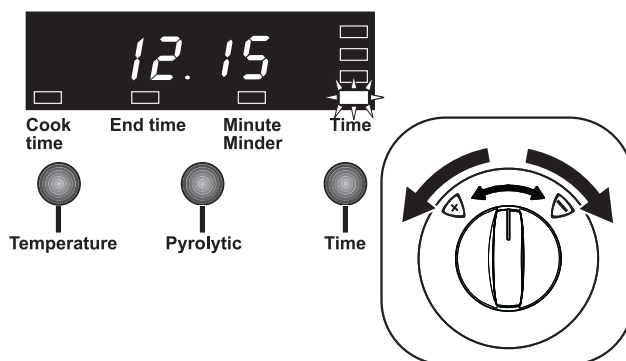

2. After the setting is carried out, wait for 5 seconds: the "Time" indicator will go out and the display will show the set time. The appliance is ready for use.

### To reset the correct time of day:

1. Press button "Time" repeatedly to select the "Time" function. The relevant indicator will start flashing. Then proceed as described above.

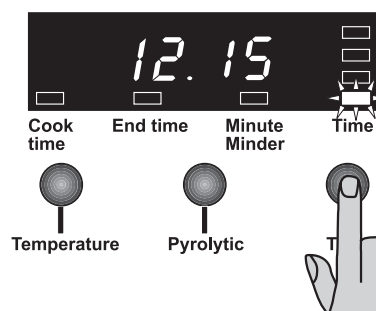

**i** The time of day can only be reset if no automatic function (cook duration or end of cooking) has been set.





## How to select a cooking function and set the temperature

The oven has seven different cooking functions.

1. Turn the oven control knob and select the required cooking function. Each time a cooking function is selected, a pre-set temperature will appear in the display.
2. If the pre-set temperature is not suitable, turn the Time/Temperature control knob to  or  to adjust the temperature in 5 degree steps.

After choosing the temperature, the oven starts heating up and the temperature level indicators will light up.

 Push button "Temperature" to display the temperature inside the oven cavity.

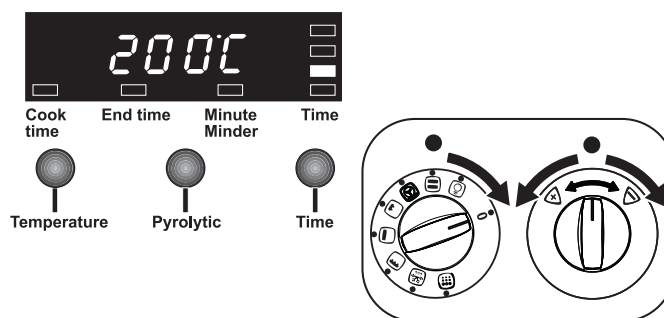

## Temperature level indicators



As soon as the oven heats up, the temperature level indicators light up, indicating the degree to which the oven is currently heated.

When the required temperature is reached, an acoustic alarm will sound for a short time and all the temperature level indicators will light permanently.

After the oven is switched off, the indicators will stay on until the temperature reaches 40 °C.

## Special functions

The following functions can be activated by pressing a button and turning the time/temperature control knob at the same time:

- Child lock: turn the time/temperature control knob to  and press "Time" button.
- Display switched on/off: turn the time/temperature control knob to  and press "Time" button.

For further details, see chapter "Safety and Energy Saving functions".

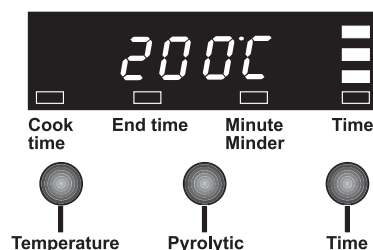





# Before the First Use of the Cooker

 Remove all packaging, both inside and outside the oven, before using the oven.

Before cooking for the first time, carefully wash the oven accessories.

Before first use, the oven should be heated without food. During this time, an unpleasant odour may be emitted. This is quite normal.

-  • Set the time of day with the electronic programmer (see paragraph "How to set the time of day").
- Switch the oven function control knob to conventional cooking  and select 250 °C with the time/temperature control knob.
  - Open a window for ventilation.
  - Allow the oven to run empty for approximately 45 minutes.

This procedure should be repeated with the pizza oven function  and full grill function  for approximately 5-10 minutes.

 Once this operation is carried out, let the oven cool down, then clean the oven cavity with a soft cloth soaked in warm water to which a little mild washing-up liquid has been added.

## Using the ceramic hob for the first time

The cooking surface should be cleaned before use to remove any traces of the production process.

-  Wipe the ceramic surface and frame with a damp cloth using warm water to which a little washing up liquid has been added, and wipe dry.

## Heating up for the first time

-  To check the cooking zones, briefly switch each one on.

# Programming the Oven

## “Minute minder” function

**i** The minute minder function can also be used when the oven is off.



The minute minder alarm will sound at the end of a timed period, but THE OVEN WILL REMAIN ON, if it is in use.

### To set the minute minder:

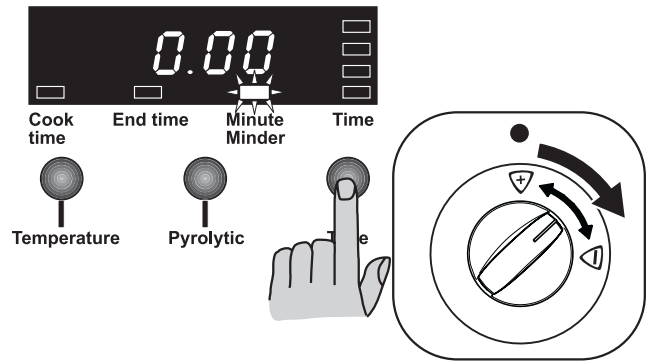
1. Press button “Time” to select the “Minute Minder” function. The relevant indicator will start flashing and the display will show “0.00”.
2. Turn the time/temperature control knob to  until the relevant indicator flashes (maximum: 99 minutes).
3. After the setting is carried out, wait for 5 seconds. The display will revert to the time of day and the minute minder will start the countdown.
4. At the end of the timed period, an acoustic alarm will be heard. To switch off the acoustic alarm, press any button.



### To change the minute minder:

1. Press button “Time” to select the “Minute Minder” function. The relevant indicator will flash.
2. Turn the time/temperature control knob to  or  to change the minute minder setting. After 5 seconds the indicator will go out and the display will revert to the time of day.

### To cancel the minute minder:

1. Press button “Time” to select the “Minute Minder” function. The relevant indicator will flash and the display will show the remaining time.
2. Turn the time/temperature control knob to  until the display shows “0.00”. After 5 seconds the indicator will go out and the display will revert to the time of day.

# How to make the oven switch off automatically

This function allows the oven to automatically switch off at the end of a programmed cooking duration time.

Place food in the oven, select a cooking function and adjust the cooking temperature (see paragraph "How to select a cooking function and set the temperature").

Press button "Time" to select the "Cook Time" function. The relevant indicator will start flashing and the display will show "0.00". Then, proceed as follows:

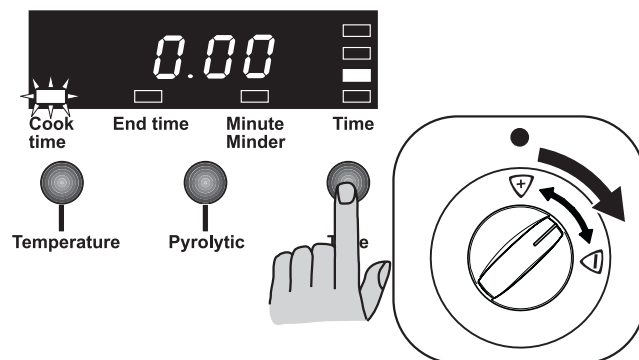

## To set the duration time:

1. Turn the time/temperature control knob to and select the required time while the relevant indicator flashes (maximum time: 9 hours 59 minutes).
2. After the setting is carried out, wait for 5 seconds. The display will show the set temperature. Press button "Time" to display the cooking time.
3. When cooking time is over, the oven will be switched off automatically and an acoustic alarm will be heard and the relevant indicator will start flashing. The display shows "0.00".
4. To switch off the acoustic alarm, turn the oven function control knob to the "OFF" position (0).

If you press a button other than the knob, the alarm will switch off and the display will show "--- °C". This means that the oven cannot be operated.

Turn the oven control knob to the "OFF" position (0) to reset the oven.

The display will revert to the time of day.

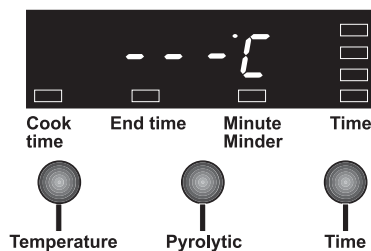
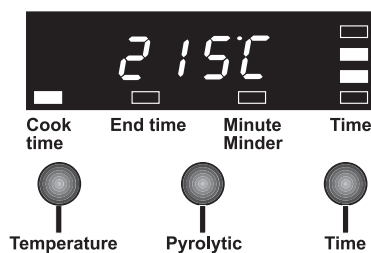

## To change the duration time:

1. Press button "Time" to select the "Cook Time" function. The relevant indicator will flash.
2. Turn the time/temperature control knob to or to change the cooking duration.

## To cancel the duration time:



1. Press button "Time" to select the "Cook Time" function. The relevant indicator will flash and the display will show the remaining cooking time.
2. Turn the time/temperature control knob to until the display shows "0.00". After 5 seconds the indicator will go out and the display will revert to the time of day.

It is not possible to set the "Cook Time" function when the oven is off.

## How to make the oven switch on and off automatically

The functions “Cook Time” and “End time” can be used simultaneously to set the oven to switch on and off automatically at a later time.

1. Set the duration time with the “Cook Time” function (carry out the cooking duration setting as described in the previous chapter). Then, press button “Time”: the display will show the programmed setting.
2. Press button “Time” repeatedly to select the “End Time” function. The relevant indicator will flash.
3. Turn the time/temperature control knob to  to set the end of cooking time.
4. After the setting is carried out, wait for 5 seconds. The relevant indicators will come on and the display will show the set temperature. The oven will switch on and off according to the set programmes and an acoustic alarm will be heard when cooking time is over.
5. To switch off the acoustic alarm, turn the oven function control knob to the “OFF” position (0). If you press a button other than the knob, the alarm will switch off and the display will show “--- °C”. This means that the oven cannot be operated. Turn the oven control knob to the “OFF” position (0) to reset the oven. The display will revert to the time of day.

-  Once you have programmed the oven, you can check both the cooking duration and end of cooking time by pressing the “Time” button.
-  Set the “Cook Time” function to zero to cancel the programme.
-  It is not possible to set the “Cook Time” and “End Time” functions when the oven is off.

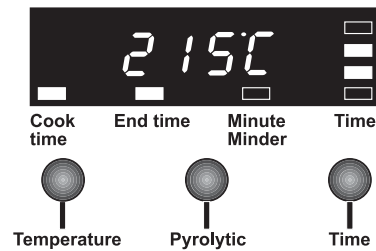
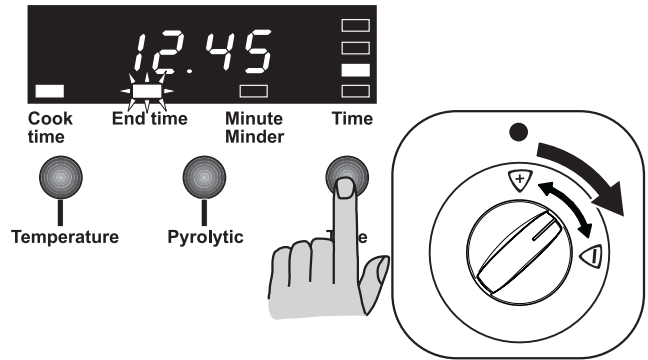

# Safety and Energy saving functions

## Safety Cut-Off Function

The oven will switch off automatically if any change of setting is made, according to the table below (Fig. 14).

If temperature setting is:	the oven will switch off:
250°C	after 1 1/2 hours
from 200 up to 245°C	after 5,5 hours
from 120 up to 195°C	after 8,5 hours
less than 120°C	after 12,5 hours

## Child Safety Function

To avoid children switching on the oven, it is possible to lock the oven controls.

**i** The child safety function can be selected only if no other function has been set.

1. Turn the time/temperature control knob to  and hold it in the turned position.
2. At the same time, press button "Time" and keep it pressed for about 3 seconds. The indication 'SAFE' will appear in the display (Fig. 15).  
After a few seconds, the display will revert to the time of day.

The oven is now locked. Neither oven functions nor temperatures can be selected.

### To unlock the oven:

1. Turn the time/temperature control knob to  and hold it in the turned position.
2. At the same time, press button "Time" and keep it pressed for about 3 seconds. The indication 'SAFE' will go off.

The oven can now be operated.

## How to switch off the display

**i** The display can be switched off only if no other function has been set.

To activate this function, proceed as follows:

1. Turn the time/temperature control knob to  and hold it in the turned position.
2. At the same time, press button "Time" and keep it pressed for about 3 seconds.  
The display will switch off.

### To switch on the display:

1. Turn the time/temperature control knob to  and hold it in the turned position.
2. At the same time, press button "Time" and keep it pressed for about 3 seconds.  
The display will switch on.

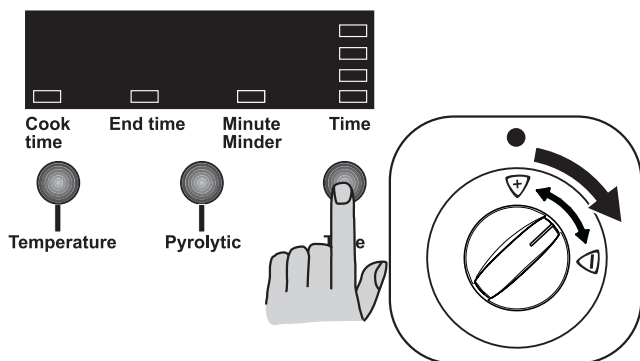
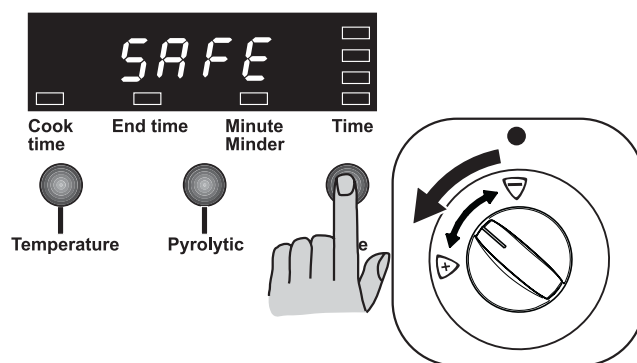

# Using the Oven



Always cook with the oven door closed.

**Stand clear when opening the drop down oven door. Do not allow it to fall open - support the door using the door handle, until it is fully open.**



The heating elements do not work when the oven door is not completely closed.

The oven has four shelf levels, and is supplied with two shelves.

The shelf positions are counted from the bottom of the oven as shown in the diagram.

It is important that these shelves are correctly positioned as shown in the diagram.



- **Warning!** - Do not place objects on the bottom of the oven and do not cover it with aluminium foil while cooking, as you can damage the enamelled surfaces and the food you are cooking. Always place pans, heat-resisting pans and aluminium foils on the oven shelves.
- **Warning!** - Be careful when you insert and extract the grid and the dripping pan from the oven in order not to damage the enamelled surfaces of the oven cavity.

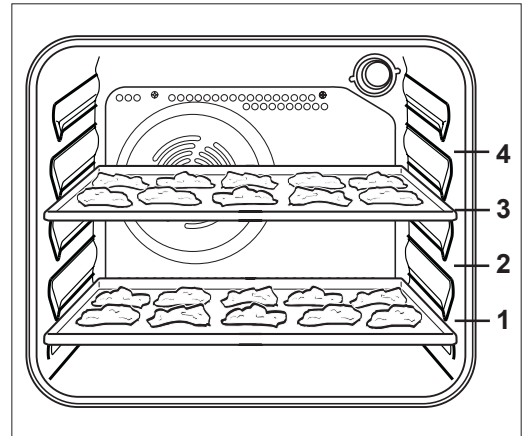

## Hints and Tips

### Condensation and Steam

When food is heated it produces steam in the same way as a boiling kettle. The oven vents allow some of this steam to escape. However, **always stand back from the oven when opening the oven door** to allow any build up of steam or heat to release.

If the steam comes into contact with a cool surface on the outside of the oven, e.g. a trim, it will condense and produce water droplets. This is quite normal and is not a fault with the oven.

To prevent discolouration, regularly wipe away condensation and also soilage from surfaces.

### Cookware

- Use any oven proof cookware which will withstand temperatures of 250°C.
- Baking trays, oven dishes, etc. should not be placed directly against the grid covering the fan at the back of the oven, or placed on the oven base.
- Do not use baking trays larger than 30 cm x 35 cm (12 in x 14 in) as they will restrict the circulation of heat and may affect performance.

### The effects of dishes on cooking results

Dishes and tins vary in their thickness, conductivity, colour, etc. which affects the way they transmit heat to the food inside them.

- A** Aluminium, earthenware, oven glassware and bright shiny utensils reduce cooking and base browning.
- B** Enamelled cast iron, anodized aluminium, aluminium with non-stick interior and coloured exterior and dark, heavy utensils increase cooking and base browning.

### Storage Drawer

The storage drawer is located underneath the oven cavity.





During cooking the storage drawer may become hot if the oven is on high for a long period of time, therefore flammable materials such as oven gloves, tea towels, plastic aprons etc. should not be stored in the drawer.

Oven accessories such as baking sheets, will also become hot, therefore care should be taken when removing these items from the drawer whilst the oven is in use or still hot.

# Using the Conventional Oven

When using this setting, heat comes from both the top and bottom elements. This allows you to cook on a single level and is particularly suitable for dishes which require extra base browning such as pizzas, quiches and flans. Gratins, lasagnes and hotpots which require extra top browning also cook well in the conventional oven. This form of cooking gives you the opportunity to cook without the fan in operation.

## How to Use the Conventional Oven

1. Turn the oven function control knob to the required cooking function ()
2. If necessary, turn the Time/Temperature control knob to  or  to adjust the temperature.

## Top oven element only

This function is suitable for finishing cooked dishes, e.g. lasagne, shepherds pie, cauliflower cheese etc.

## Hints and Tips

The middle shelf position allows for the best heat distribution. To increase base browning simply lower the shelf position. To increase top browning, raise the shelf position.

The material and finish of the baking trays and dishes used will affect base browning. Enamelware, dark, heavy or non-stick utensils increase base browning, while oven glassware, shiny aluminium or polished steel trays reflect the heat away and give less base browning.

Always place dishes centrally on the shelf to ensure even browning.

Stand dishes on suitably sized baking trays to prevent spillage onto the base of the oven and make cleaning easier.

**Do not** place dishes, tins or baking trays directly on the oven base as it becomes very hot and damage will occur.

For faster preheating use the fan oven function to preheat the oven until the oven indicator neon goes out, then switch the selector to the conventional oven setting.

 Single level cooking gives best results. If you require more than one level cooking use the fan oven function.

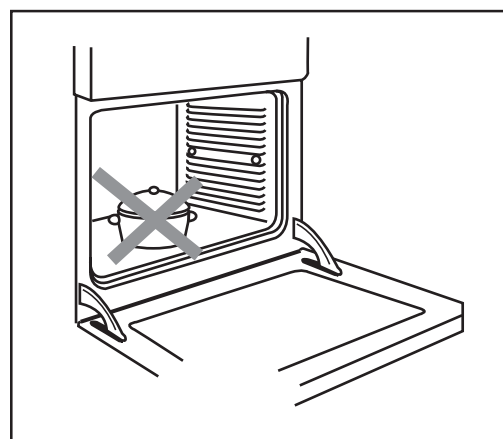
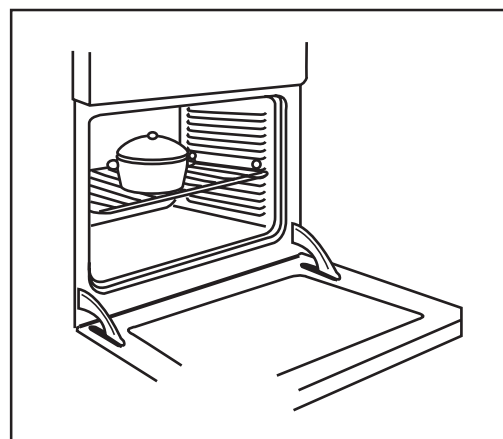



# Cooking Chart - Conventional Oven



These charts are intended as a guide only. It may be necessary to increase or decrease the temperature to suit your individual requirements. Only experience will enable you to determine the correct setting for your personal requirements.

Weight (gr.)	Type of dish	Shelf position 	Temperature °C	Cooking time in minutes	Notes
	<b>CAKES</b>				
	Whisked recipes	2	170	45 ~ 60	In cake mould
	Shortbread dough	2	170	20 ~ 30	In cake mould
	Butter-milk cheese cake	1	160	60 ~ 80	In cake mould
	Apple cake	1	180	40 ~ 60	In cake mould
	Strudel	2	175	60 ~ 80	
	Jam-tart	2	175	30 ~ 40	
	Fruit cake	1	175	45 ~ 60	In bread tin
	Sponge cake	1	175	30 ~ 40	In cake mould
	Christmas cake	1	170	40 ~ 60	In cake mould
	Plum cake	1	170	50 ~ 60	In bread pan
	Small cakes	2	175	25 ~ 35	In baking tray
	Biscuits	2	160	20 ~ 30	In baking tray
	Meringues	2	100	90 ~ 120	In baking tray
	Buns	2	190	12 ~ 20	In baking tray
	Pastry: Choux	2	200	15 ~ 25	In baking tray
	<b>BREAD AND PIZZA</b>				
1000	White bread	1	190	40 ~ 60	1-2 pieces
500	Rye bread	1	190	30 ~ 45	In bread tin
500	Bread rolls	2	200	20 ~ 35	6-8 rolls
250	Pizza	1	210	15 ~ 30	on baking tray
	<b>FLANS</b>				
	Pasta flan	2	200	40 ~ 50	in mould
	Vegetable flan	2	200	45 ~ 60	in mould
	Quiches	1	200	35 ~ 45	in mould
	Lasagne	2	180	45 ~ 60	in mould
	Cannelloni	2	200	40 ~ 55	in mould
	<b>MEAT</b>				
1000	Beef	2	190	50 ~ 70	On grid
1200	Pork	2	180	100 ~ 130	On grid
1000	Veal	2	190	90 ~ 120	On grid
1500	English roast beef				
1500	underdone	2	210	50 ~ 60	On grid
1500	done	2	210	60 ~ 70	On grid
1500	well done	2	210	70 ~ 80	On grid
2000	Shoulder of pork	2	180	120 ~ 150	with rind
1200	Shin of pork	2	180	100 ~ 120	2 pieces
1200	Lamb	2	190	110 ~ 130	Leg
1000	Chicken	2	190	60 ~ 80	Whole
4000	Turkey	2	180	210 ~ 240	Whole
1500	Duck	2	175	120 ~ 150	Whole
3000	Goose	2	175	150 ~ 200	Whole
1200	Rabbit	2	190	60 ~ 80	Cut in pieces
1500	Hare	2	190	150 ~ 200	Cut in pieces
800	Pheasant	2	190	90 ~ 120	Whole
	Meat loaf	2	180	40 ~ 60	In bread pan
	<b>FISH</b>				
1200	Trout/Sea bream	2	190	30 ~ 40	3-4 fishes
1500	Tuna fish/Salmon	2	190	25 ~ 35	4-6 fillets



Cooking times in the tables do not include pre-heating. We recommend, especially when cooking cakes, pizza and bread, to pre-heat the oven for about 10 minutes before cooking.

# Pizza Oven

The bottom element provides direct heat to the base of pizzas, quiches or pies, while the fan ensures air is circulated to cook the pizza toppings or pie fillings. To obtain the best results use the lower shelf levels.

1. Turn the oven function control knob to the required cooking function ().
2. If necessary, turn the Time/Temperature control knob to  or  to adjust the temperature.

## Pizza Oven

Weight (gr.)	TYPE OF DISH	Pizza function		Cooking time  minutes	NOTES
		Level 	temp. °C		
700	Pizza, large	1	200	15 ~ 25	on baking tray
500	Pizza, small	1	200	10 ~ 20	on baking tray or on grid
500	Flat cake	1	200	15 ~ 25	on baking tray

Cooking times in the table do not include pre-heating. We recommend to pre-heat the oven for about 10 minutes before cooking.

# Grilling



**Grilling must be carried out with the oven door closed. The grill pan handles must be removed from the pan.**



**The grill cavity becomes very hot during use. Caution must be used when removing and replacing the grill pan handles. If necessary oven gloves should be used to protect the hands.**



## How to Use the Full Grill

1. Turn the oven function control knob to the required cooking function (☞).
2. If necessary, turn the Time/Temperature control knob to + or - to adjust the temperature.
3. Adjust the grid and grill pan runner position to allow for different thicknesses of food. Position the food close to the element for faster cooking and further away for more gentle cooking.

Preheat the grill on a full setting for a few minutes before sealing steaks or toasting. Adjust the heat setting and the shelf as necessary during cooking.

During cooking, the cooling fan will operate.

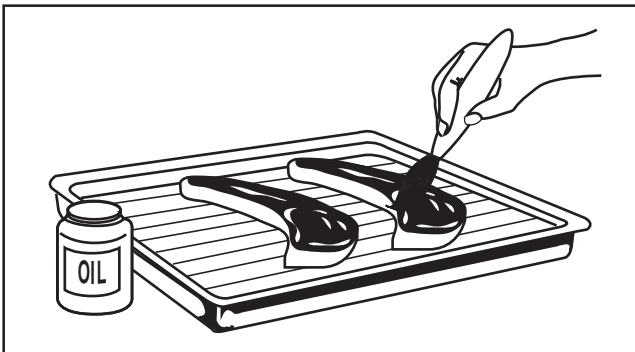

## Hints and Tips

- Most foods should be placed on the grid in the grill pan to allow maximum circulation of air to lift the food out of the fats and juices. Food such as fish, liver and kidneys may be placed directly on the grill pan, if preferred.
- Food should be thoroughly dried before grilling to minimise splashing. Brush lean meats and fish lightly with a little oil or melted butter to keep them moist during cooking.
- Accompaniments such as tomatoes and mushrooms may be placed underneath the grid when grilling meats
- When toasting bread, we suggest that the top runner position is used.
- The food should be turned over during cooking, as required.

**During cooking, the grill cycles on and off to prevent overheating.**



## How to Use the Inner Grill

The grill provides quick direct heat to the central area of the grill pan. Use the inner grill element for cooking small quantities, it can help to save energy.

1. Turn the oven function control knob to the required cooking function (☞).
2. If necessary, turn the Time/Temperature control knob to + or - to adjust the temperature.
4. Adjust the heat setting and the shelf as necessary, for different thicknesses of food and follow the instructions for grilling.

## Grilling ☞ - ☞

TYPE OF DISH	Quantity		Grilling		Cooking time (minutes) ⌚	
	Pieces	Weight	Level	temp. °C	Upper side	Lower side
Fillet steaks	4	800	3	max	12 ~ 15	12 ~ 14
Beef-steaks	4	600	3	max	10 ~ 12	6 ~ 8
Sausages	8	—	3	max	12 ~ 15	10 ~ 12
Pork chops	4	600	3	max	12 ~ 16	12 ~ 14
Chicken (cut in two)	2	1000	3	max	30 ~ 35	25 ~ 30
Kebabs	4	—	3	max	10 ~ 15	10 ~ 12
Chicken (breast)	4	400	3	max	12 ~ 15	12 ~ 14
Hamburger	6	600	3	max	10 ~ 15	8 ~ 10
Fish (fillets)	4	400	3	max	12 ~ 14	10 ~ 12
Sandwiches	4-6	—	3	max	3 ~ 7	—
Toast	4-6	—	3	max	2 ~ 4	2 ~ 3

The chart is intended as a guide only and should be adjusted according to taste. Cooking time depends on the thickness of the meat and not on its weight.

# Defrosting

The oven fan operates without heat and circulates the air, at room temperature, inside the oven. This increases the speed of defrosting. However, please note that the temperature of the kitchen will influence the speed of defrosting.

This function is particularly suitable for delicate food which could be damaged by heat, e.g. cream filled gateaux, iced cakes, pastries, bread and other yeast products.

## How to Use Defrosting

Turn the oven function control knob to .

## Hints and Tips

- Cover food with a lid, aluminium foil or plastic film to prevent drying out during defrosting.
- ALWAYS COOK THOROUGHLY IMMEDIATELY AFTER THAWING.
- Frozen food should be placed in a single layer when ever possible and turned over half way through the defrosting process.
- Only joints of meat and poultry up to 2 kg. (4 lb.) are suitable for defrosting in this way.

Refer to the following table for approximate defrosting times.

## Defrosting Chart

Food	Defrosting time (Mins)	Standing time (Mins)	Notes
Chicken 1000 g.	100-140	20-30	Place the chicken on an inverted saucer on a large plate. Defrost open and turn at half time or defrost covered with foil. Remove giblets as soon as possible.
Meat 1000 g.	100-140	20-30	Defrost open and turn at half time or cover with foil
Meat 500 g.	90-120	20-30	As above
Trout 150 g.	23-35	10-15	Defrost open
Strawberries 300 g.	30-40	10-20	Defrost open
Butter 250 g.	30-40	10-15	Defrost open
Cream 2 x 200 g.	80-100	10-15	Defrost open (cream is easy to whip even if parts of it are still slightly frozen)
Cake 1400 g.	60	60	Defrost open

The times quoted in the chart should be used as a guide only, as the speed of defrosting will depend on the kitchen temperature. For example, the colder the ambient temperature, the longer the defrosting time.

# Maintenance and Cleaning



Before any maintenance or cleaning can be carried out, you must **DISCONNECT** the cooker from the electricity supply.

This appliance cannot be cleaned with steam or with a steam cleaning machine.

## The Hob Top

The hob is best cleaned whilst it is still warm, as spillage can be removed more easily than if it is left to cool.

Regularly wipe over the hob top using a soft cloth well wrung out in warm water to which a little washing up liquid has been added. Avoid the use of the following:

- household detergent and bleaches;
- impregnated pads unsuitable for non-stick saucepans;
- steel wool pads;
- bath/sink stain removers.

Should the hob top become heavily soiled, it is recommended that a cleaning product such as Hob Brite or Bar Keepers Friend is used.

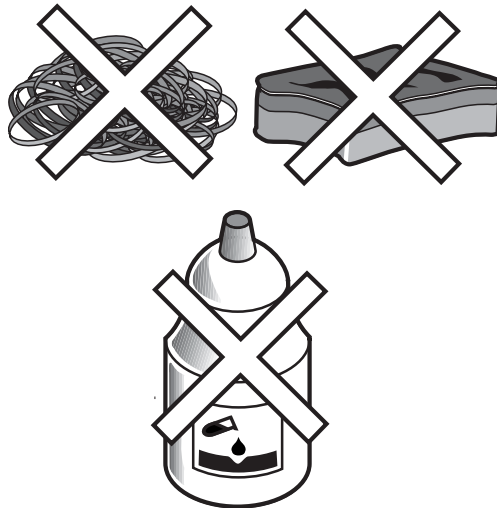

## Pan Supports

The hob has cast iron pan supports. Take care when removing them. They are fairly heavy and could damage the hob or your kitchen furniture if you let them fall down.

Wash the pan supports using hot soapy water.

If necessary, a paste cleaner or a soap impregnated steel wool pad can be used with caution.

## The Burners

The burner caps and crowns can be removed for cleaning. Wash the burner caps and crowns using hot soapy water, and remove marks with a mild paste cleaner. A well moistened soap impregnated steel wool pad can be used with caution, if the marks are particularly difficult to remove. After cleaning, be sure to wipe dry with a soft cloth.

## Ignition electrode

The electric ignition is obtained through a ceramic and metal electrode (see diagram page 5 - letter C). Keep these components very clean, to avoid lighting difficulties, and check that the burner crown holes are not obstructed.

# Cleaning the Oven



*The oven should be kept clean at all times. A build-up of fats or other foodstuffs could result in a fire, especially in the grill pan.*

## Cleaning materials

Before using any cleaning materials on your oven, check that they are suitable and that their use is recommended by the manufacturer.

Cleaners that contain bleach should NOT be used as they may dull the surface finishes. Harsh abrasives should also be avoided.

- Never use steam or steam machines to clean the appliance.

## External cleaning

Regularly wipe over the control panel, oven door and door seal using a soft cloth well wrung out in warm water to which a little washing up liquid has been added.

**To prevent damaging or weakening the door glass panels avoid the use of the following:**



- Household detergent and bleaches
- Impregnated pads unsuitable for non-stick saucepans
- Brillo/Ajax pads or steel wool pads
- Chemical oven pads or aerosols
- Rust removers
- *Bath/Sink stain removers*

Clean the outer and inner door glass using warm soapy water. Should the inner door glass become heavily soiled it is recommended that a cleaning product such as Hob Brite, or Bar Keepers Friend is used.



**DO NOT clean the oven door while the glass panels are warm. If this precaution is not observed the glass panel may shatter.**

*If the door glass panel becomes chipped or has deep scratches, the glass will be weakened and must be replaced to prevent the possibility of the panel shattering. Contact your local Service Centre who will be pleased to advise further.*

### Models in stainless steel or aluminium:

We recommend to clean the oven door using only a wet sponge and dry it up after cleaning with a soft cloth.

Never use steel wool, acids or abrasive products as they can damage the oven surface.

Clean the oven control panel following the same precautions.

## Oven Shelves

To clean the oven shelves, soak in warm soapy water and remove stubborn marks with a well wetted soap impregnated pad. Rinse well and dry with a soft cloth.

## Pyrolytic cleaning

The oven cavity is coated with a special enamel resistant to high temperatures.

During the pyrolytic cleaning process, the temperature inside the oven can reach about 500 °C thus burning food residuals.

For your security, during the pyrolytic cleaning process, the oven door automatically locks when the temperature inside the oven approaches about 300 °C.

The door remains locked during the cleaning operation until the end of the pyrolytic cleaning function.

After the oven cavity has cooled down, the door unlocks. The cooling fan operates during cooking until the oven has cooled down. After each cooking, it is advisable to remove all the food residuals with a wet sponge.

However, from time to time, it will be necessary to do a more complete and thorough cleaning, using the pyrolytic cleaning function. You can select two different levels of pyrolytic cleaning depending on how dirty the oven is.

If the oven cavity is not very dirty, we recommend to select the pyrolytic 1 function (PYr 1) on the programmer display.

It is advisable to wipe the oven over with a soft sponge soaked in warm water after each pyrolytic cleaning cycle is carried out.

If the oven cavity is very dirty, we advise you to select the pyrolytic 2 function (PYr 2) on the programmer display.

During the pyrolytic cleaning function, it is not possible to use the oven for 2 hours when selecting the PYr 1 function and up to 2 hours and a half when the PYr 2 function is active.

# How to use the pyrolytic cleaning function

 Before activating the pyrolytic cleaning function, remove any excessive spillage and make sure that the oven is empty. Do not leave anything inside it (e.g. pans, grids, baking tray, dripping pan) as this could severely damage them.

 Ensure that the oven door is closed before activating the pyrolytic cleaning function.

 When the pyrolytic cleaning function is on, it is advisable not to use the hob as this could cause overheating and damage the appliance.

 During the pyrolytic cleaning cycle the oven door becomes hot. Children should be **KEPT AWAY** until it has cooled.

Choose this function to clean the oven by pyrolysis.

The following pyro levels are available:

Pyrolytic 1 (PYr 1) time : 2 h = 30 min heat-up + 1 h at 480°C + 30 min cooling down.

Pyrolytic 2 (PYr 2) time : 2 h 30 min. = 30 min heat-up + 1 h 30 min at 480°C + 30 min cooling down.

 The pyrolytic cleaning cycle duration/time cannot be changed.

1. Turn the oven knob to position . The "Cook Time" indicator and the PYr I indication will flash in the display (Fig. 22).
2. Press "Pyrolytic" button to activate the pyrolytic cleaning function. The temperature indicators will start lighting alternatively. This means that the oven is rapidly heating up.

The "PYr I" indication will stop to flash, the oven light will go out and the pyrolytic cleaning cycle will start (Fig. 24).

If the oven cavity is very dirty, we advise you to select the pyrolytic 2 function (PYr 2) on the programmer display.

1. Press "Pyrolytic" button to select the pyrolytic 2 (PYr 2) function.

 Press button "Time" to display the remaining time.

After some time, the temperature level indicators will light permanently in the display. This means that the oven door has been locked.

At the end of the pyrolytic cleaning process, "0.00" will flash in the display.

Once the oven has cooled down (check the temperature level indicators coming off one by one), the oven door will unlock.

To reset the oven, turn the oven function control knob to the "OFF" position (0).

If you press a button other than the knob, the alarm will switch off and the display will show "--- °C". This means that the oven cannot be operated.

To reset the oven, turn the oven function control knob to the "OFF" position (0).

To stop the pyrolytic cleaning cycle at any time, turn the oven function control knob to the "OFF" position (0).

**NOTE:** The time indication is comprehensive of the cool down time.

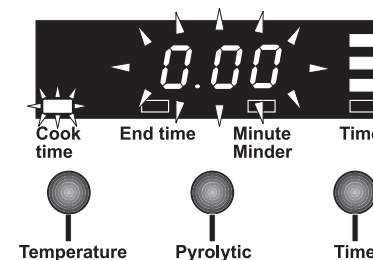
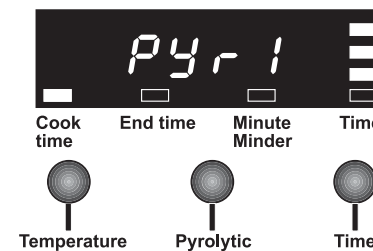
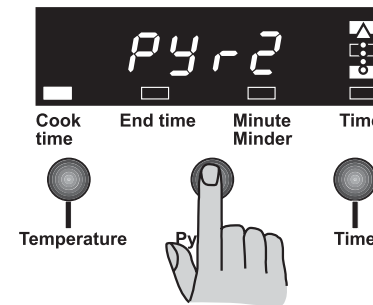
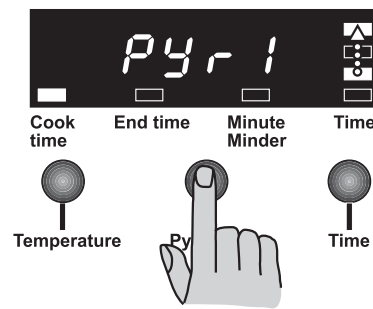
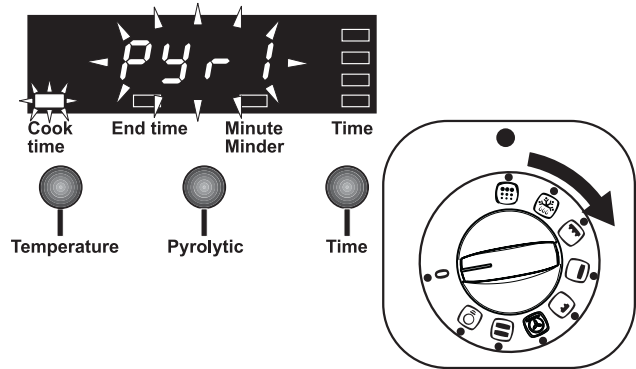

**i** If you turn the oven knob to a cooking function while the pyrolytic function is active, the cleaning cycle will be interrupted.

If the oven door lock is activated, it is impossible to select any cooking until the door lock is off.

## To programme the pyrolytic cleaning cycle (delayed start, automatic stop)

If you wish, you can programme the starting and ending time of the pyrolytic cleaning cycle.

1. Turn the oven knob to position . The “Cook Time” indicator and the PYr I indication will flash in the display (Fig. 22).
2. Press “Pyrolytic” button to activate the pyrolytic cleaning function. The temperature indicators will start lightning alternatively. This means that the oven is rapidly heating up.  
The “PYr I” indication will stop to flash, the oven light goes out and the pyrolytic cleaning cycle starts (Fig. 24).

If the oven cavity is a lot dirty, we advise you to select the pyrolytic 2 function (PYr 2) on the programmer display.

1. Press “Pyrolytic” button to select the pyrolytic 2 (PYr 2) function.
2. Press button “Time” twice to display the end time of the cleaning cycle. After the setting is carried out, the “Cook Time” and “End Time” indicators will light permanently.
3. Turn the time/temperature control knob to  to select the the end time of the cleaning cycle.

The pyrolytic cleaning cycle will start according to the programmed time. The temperature level indicators will light up alternatively. This means that the oven is rapidly heating up.

After some time, the temperature level indicators will light permanently in the display. This means that the oven door has been locked.

At the end of the pyrolytic cleaning process, “0.00” will flash in the display.

Once the oven has cooled down (check the temperature level indicators coming off one by one), the oven door will unlock.

To reset the oven, turn the oven function control knob to the “OFF” position (0).

If you press a button other than the knob, the alarm will switch off and the display will show “--- °C”. This means that the oven cannot be operated.

To reset the oven, turn the oven function control knob to the “OFF” position (0).

To stop the pyrolytic cleaning cycle at any time, turn the oven function control knob to the “OFF” position (0).

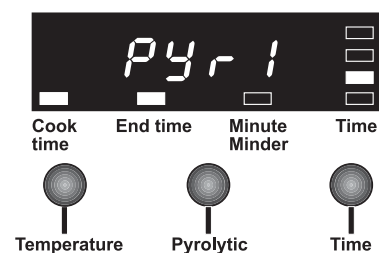
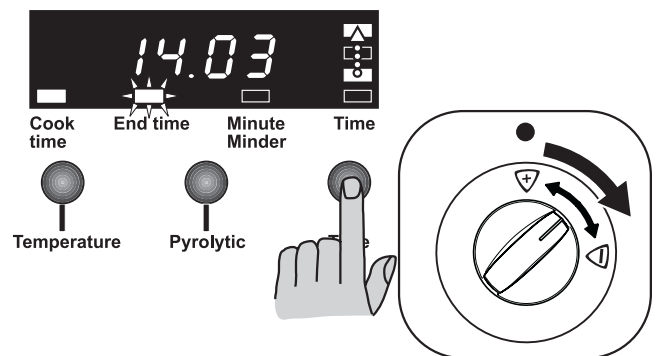



# Cleaning The Oven Door

The oven door is made up of four glasses.  
It is possible to remove them for easier cleaning.



Warning - The oven door may bang shut if you try to extract the inner glasses when the oven door is still fitted to the oven.

Before cleaning the oven door, we recommend you to remove it from the oven.

Proceed as follows:

1. open the oven door completely and locate the two hinges which link the door to the oven;

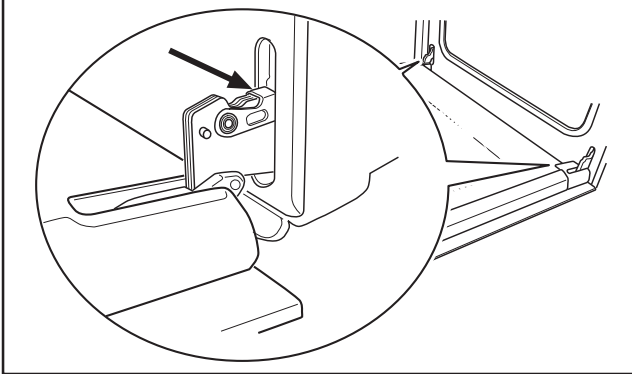

2. unlock and turn the small levers located on the two hinges;

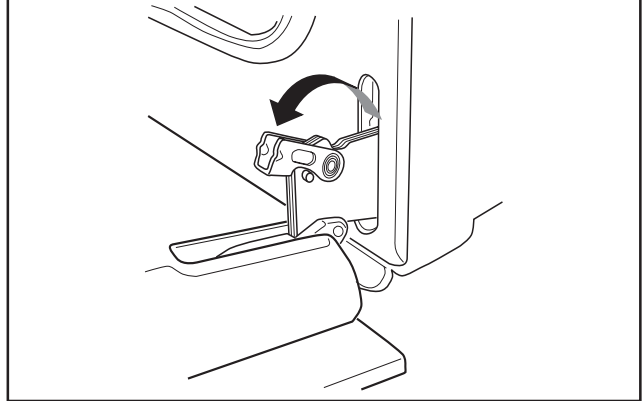

3. handle the door by its left- and right-hand sides, then slowly turn it towards the oven until it is half-closed; at this point, gently pull the oven door away from the oven frame;

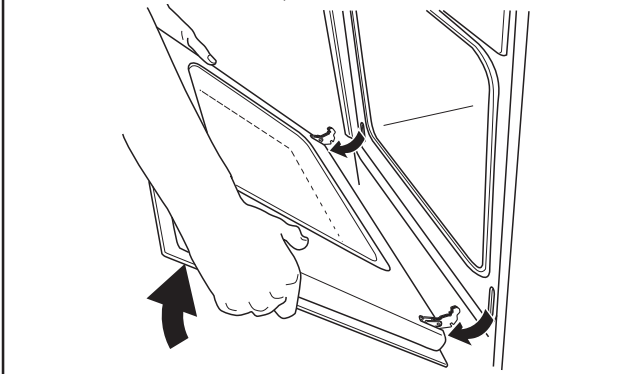

4. place the oven door on a solid surface, being careful to avoid the glass becoming scratched. Then remove the two screws located on the sides of the oven door;

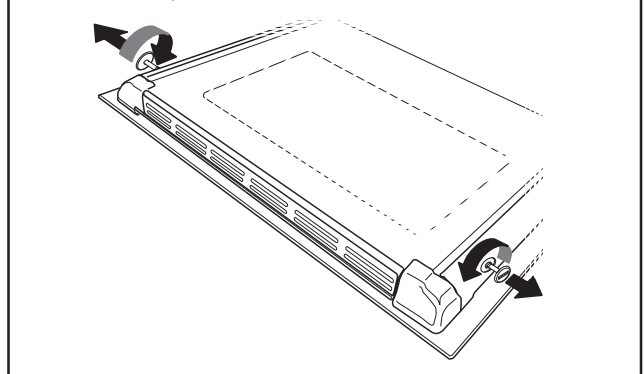

5. extract the inner glass support;

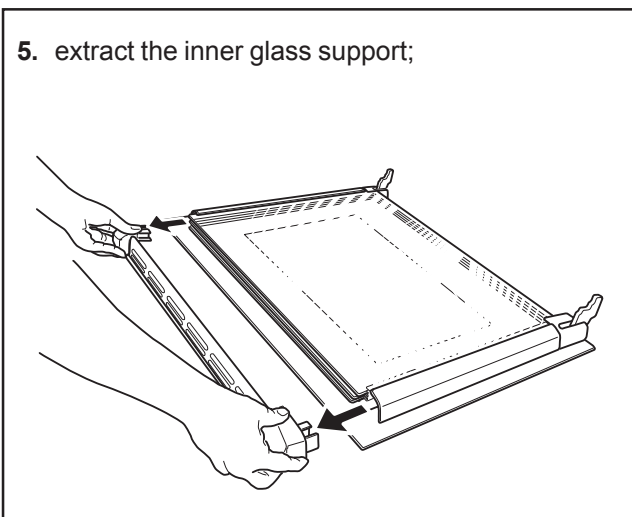

6. gently extract the three inner glasses, starting with the uppermost one first.

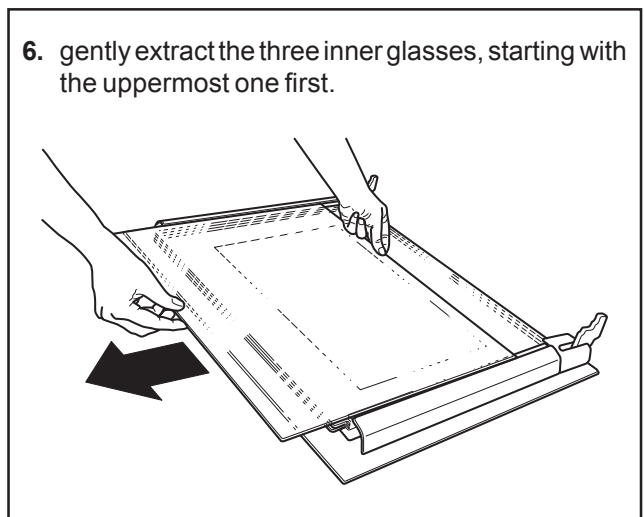

Clean the oven door glass with warm water and a soft cloth only. Never use harsh abrasives as they could damage the special heat-resistant surface of the inner glasses. Once the cleaning is carried out, refit the oven door, following the procedure in reverse.

**The two glasses in the middle are special glasses that have been treated to resist heat. They are marked with a small dot located on a corner and a black frame respectively.**

**It is important that, when refitting the oven door, the inner glasses are fixed in the right position.**

**To check if this operation has been carried out correctly, when inserting the glass, make sure that the surface of the glass marked with a black frame looks downwards and that the dot is located on the upper left corner of the glass (see diagram 7).**

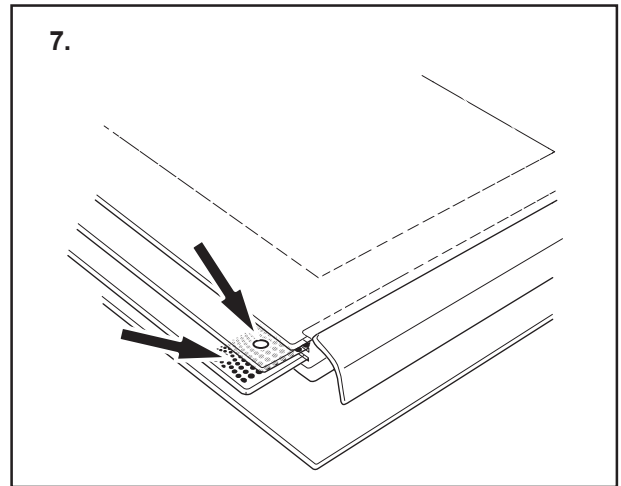

*DO NOT clean the oven door while the glass panels are warm. If this precaution is not observed the glass panels may shatter.*

*If the door glass panels become chipped or have deep scratches, the glasses will be weakened and must be replaced to prevent the possibility of the panel shattering. Contact your local Service Force Centre who will be pleased to advise further.*

## Oven lamp replacement



**Disconnect the appliance from the electricity supply.**

If the oven bulb needs replacing, it must comply with the following specifications: electric power, 40 W; electric rate, 230 V (50 Hz); resistant to temperatures of 300°C; connection type: E14. These bulbs are available from your local Service Force Centre.

 To replace the faulty bulb:

1. Ensure the oven is disconnected from the electrical supply.
2. Turn the glass cover anticlockwise.
3. Remove the faulty bulb and replace it with the new one.
4. Refit the glass cover.
5. Reconnect to the electrical supply.

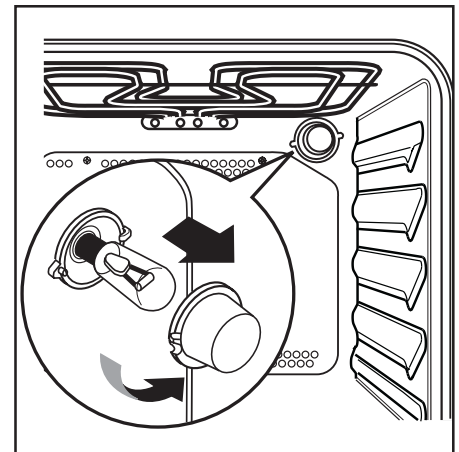

# Something not working

If the appliance is not working correctly, please carry out the following checks, before contacting your local Service Centre.

**IMPORTANT:** If you call out an engineer to a fault listed below, or to repair a fault caused by incorrect use or installation, a charge will be made even if the appliance is under guarantee.

SYMPTOM	SOLUTION
<ul style="list-style-type: none"> <li>■ There is no spark when lighting the gas</li> </ul>	<ul style="list-style-type: none"> <li>◆ Check that the unit is plugged in and the electrical supply is switched on</li> <li>◆ Check that the RCCB has not tripped (if fitted)</li> <li>◆ Check the mains fuse has not blown</li> <li>◆ Check the burner cap and crown have been replaced correctly, e.g. after cleaning.</li> </ul>
<ul style="list-style-type: none"> <li>■ The gas ring burns unevenly</li> </ul>	<ul style="list-style-type: none"> <li>◆ Check the main jet is not blocked and the burner crown is clear of food particles.</li> <li>◆ Check the burner cap and crown have been replaced correctly, e.g. after cleaning.</li> </ul>
<ul style="list-style-type: none"> <li>■ The oven does not come on.</li> </ul>	<ul style="list-style-type: none"> <li>◆ Check that a cooking function has been selected.</li> <li>◆ Check the oven is in manual operation.</li> <li>◆ Check that the socket switch or the switch from the mains supply to the cooker are ON.</li> </ul>
<ul style="list-style-type: none"> <li>■ The oven light does not come on.</li> </ul>	<ul style="list-style-type: none"> <li>◆ Select a function with the oven function control knob.</li> <li>◆ Check the light bulb, and replace it if necessary (see "Oven Lamp replacement").</li> </ul>
<ul style="list-style-type: none"> <li>■ It takes too long to finish the dishes, or they are cooked too fast.</li> </ul>	<ul style="list-style-type: none"> <li>◆ The temperature may need adjusting.</li> </ul>
<ul style="list-style-type: none"> <li>■ Steam and condensation settle on the food and the oven cavity.</li> </ul>	<ul style="list-style-type: none"> <li>◆ Refer to the contents of this booklet, especially to the chapter "Using the Oven".</li> <li>◆ Leave dishes inside the oven no longer than 15-20 minutes after the cooking is completed.</li> </ul>
<ul style="list-style-type: none"> <li>■ The oven fan is noisy.</li> </ul>	<ul style="list-style-type: none"> <li>◆ Check that shelves and bakeware are not vibrating in contact with the oven back panel.</li> </ul>
<ul style="list-style-type: none"> <li>■ The display shows "12.00".</li> </ul>	<ul style="list-style-type: none"> <li>◆ Set the time of day (see chapter "How to set the time of day").</li> </ul>

# Service and Spare Parts

## **SERVICE FORCE**

In the event of your appliance requiring service, or if you wish to purchase spare parts, please contact your local Service Force Centre by telephoning:

**0870 5 929929**

Your telephone call will be automatically routed to the Service Force Centre covering your post code area. For the address of your local Service Force Centre and further information about Service Force, please visit the website at [www.serviceforce.co.uk](http://www.serviceforce.co.uk)

For Customer Service in the Republic of Ireland please contact us at the address below:

Zanussi-Electrolux  
Electrolux Group (Irl) Ltd  
Long Mile Road  
Dublin 12  
Republic of Ireland  
Tel: +353 (0) 1 4090 751  
Email: [service.eid@electrolux.ie](mailto:service.eid@electrolux.ie)

Before calling out an engineer, please ensure you have read the details under the heading "Something Not Working."

When you contact the Service Force Centre you will need to give the following details:

1. Your name, address and post code
2. Your telephone number
3. Clear and concise details of the fault
4. The model and serial number of the appliance (found on the rating plate)
5. The purchase date

**Please note that a valid purchase receipt or guarantee documentation is required for in-guarantee service calls.**

## Customer Care Department

For general enquiries concerning your Zanussi-Electrolux appliance or for further information on Zanussi-Electrolux products, please contact our Customer Care Department by letter or telephone at the address below or visit our website at [www.zanussi.co.uk](http://www.zanussi.co.uk)

### Customer Care Department

Zanussi-Electrolux  
Cornwall House  
55-77 High Street  
Slough  
Berkshire  
SL1 1DZ  
08705 727727 (\*)

\* calls to this number may be recorded for training purposes.

# Guarantee Conditions

## Zanussi-Electrolux Guarantee conditions

We, Zanussi-Electrolux, undertake that if, within 24 months of the date of the purchase, this Zanussi-Electrolux appliance or any part thereof is proved to be defective by any reason only of faulty workmanship or materials, we will, at our option, repair or replace the same **FREE OF ANY CHARGE** for labour, materials or carriage on condition that:

- \* The appliance has been correctly installed and used only on the gas and electricity supply stated on the rating plate.
- \* The appliance has been used for normal domestic purpose only, and in accordance with the manufacturer's instructions.
- \* The appliance has not been serviced, maintained, repaired, taken apart or tampered with by any person not authorised by us.
- \* All service work under this guarantee must be undertaken by a Zanussi-Electrolux Service Centre.
- \* Any appliance or defective part replaced shall become the Company's property.
- \* This guarantee is in addition to your statutory and other legal rights.

Home visits are made between **8.30am and 5.30pm** Monday to Friday. Visits may be available outside these hours, in which case a **premium** will be charged.

## Exclusions

**This guarantee does not cover:**

- \* Damage or calls resulting from transportation, improper use or neglect, the replacement of any light bulbs or removable parts of glass or plastic.
- \* Costs incurred for calls to put right an appliance which is improperly installed or calls to appliance outside the United Kingdom.
- \* Appliances found to be in use within a commercial or similar environment, plus those which are the subject to rental agreements.
- \* Products of Electrolux-Zanussi manufacture which are not marketed by Electrolux.

## European Guarantee

If you should move to another country within Europe then your guarantee moves with you to your new home subject to the following qualifications:

- \* The guarantee starts from the date you first purchased your product.
- \* The guarantee is for the same period and to the same extent for labour and parts as exist in the new country of use for this brand or range of products.
- \* This guarantee relates to you and cannot be transferred to another user.
- \* Your new home is within the European Community (EC) or European Free Trade Area.
- \* The product is installed and used in accordance with our instructions and is only used domestically, i.e. a normal household
- \* The product is installed taking into account regulations in your new country.

Before you move, please contact your nearest Customer Care centre, listed below, to give them details of your new home. They will then ensure that the local Service Organisation is aware of your move and able to look after you and your appliances.

France	Senlis	+33 (0)3 44 62 29 99
Germany	Nürnberg	+49 (0)911 323 2600
Italy	Pordenone	+39 (0)1678 47053
Sweden	Stockholm	+46 (0)8 738 79 50
UK	Slough	+44 (0)1753 219897

# Instructions for the Installer

## Technical Data

Appliance Class 2 sub class 1 and Class 1  
 APPLIANCE CATEGORY: I12H3+  
 APPLIANCE GAS SUPPLY: Natural Gas 20 mbar

## Dimensions

Height 900 mm  
 Depth 600 mm  
 Width 600 mm  
 Oven Capacity 56 litres / 1.97 Cu. ft

## Hob

Rear left burner (semi-rapid) 2,0 kW  
 Front left burner (ultra-rapid triple crown) 4,0 kW  
 Rear right burner (semi-rapid) 2,0 kW  
 Front right burner (auxiliary) 1,0 kW

## Oven

Top heating element 800 W  
 Bottom heating element 1,000 W  
 Oven element 1,800 W  
 Grill Element (inner) 1,650 W  
 Grill Element (full) 2,450 W  
 Pizza Oven 3,000 W  
 Convection heating element 2,000 W  
 Pyrolytic cleaning function 2,450 W  
 Convection fan 30 W  
 Oven light 40 W  
 Total rating 3,100 W  
 Supply voltage (50 Hz) 230 V

TYPE OF GAS	CHARACTERISTICS	BURNER	ULTRARAPID (large)		SEMI-RAPID (medium)		AUXILIARY (small)	
		POSITION	MAX	MIN	MAX	MIN	MAX	MIN
NATURAL GAS 20 mbar	VALUE = Hs 37.78 MJ/m <sup>3</sup> Ws 50.72 MJ/m <sup>3</sup>	NOMINAL THERMAL POWER kW	4.0	1.20	2.0	0.45	1.0	0.33
		NOMINAL FLOW RATE m <sup>3</sup> /h	0.381	0.114	0.190	0.043	0.095	0.031
		NOZZLE REFERENCE 1/100 mm	146	Adjust.	96	Adjust.	70	Adjust.
LPG GAS 28-30/37 mbar	VALUE = Hs 49.92 MJ/Kg Ws 82.09 MJ/m <sup>3</sup>	NOMINAL THERMAL POWER kW	4.0	1.20	2.0	0.45	1.0	0.33
		NOMINAL FLOW RATE g/h	288	86	144	32	72	24
		NOZZLE REFERENCE 1/100 mm	98	56	71	32	50	28

# Important Safety Requirements

This appliance must be installed in accordance with the Gas Safety (Installation and Use) Regulations (current addition) and the I.E.E. Wiring Regulations. Detailed recommendations are contained in the following British Standard Codes of Practice - B.S. 6172, B.S. 5440: Part 2 and B.S. 6891: Current Editions. For appliances installed in the Republic of Ireland please refer to NSAI- Domestic Gas Installation I.S. 813 Current Editions and the ETCI Rules for Electrical Installations.

## Provision for Ventilation

The room containing the cooker should have an air supply in accordance with B.S. 5440: Part 2: Current Editions. The following requirements for ventilation must be met.

The cooker should not be installed in a bed sitting room with a volume of less than 20m<sup>3</sup>, if it is installed in a room of volume less than 5m<sup>3</sup> an air vent of effective area of 110cm<sup>2</sup> is required; if it is installed in a room of volume between 5m<sup>3</sup> and 10m<sup>3</sup>, an air vent of effective area 50cm<sup>2</sup> is required, while if the volume exceeds 11m<sup>3</sup> no air vent is required. However, if the room has a door which opens directly to the outside, no air vent is required even when the volume is between 5m<sup>3</sup> and 11m<sup>3</sup>.

If there are other fuel burning appliances in the same room, B.S. 5440: Part. 2: Current Editions should be consulted to determine the requisite air vent requirements.

For appliances installed in the Republic of Ireland please refer to the NSAI- Domestic Gas Installation I.S. 813 Current Editions Table Four.

## Location of the appliance

This appliance must not be installed in a bed-sitting room of volume less than 20m<sup>3</sup> or in a bathroom, shower room or garage. It is essential that the appliance is positioned as stated below (see fig.1) i.e. shelves, wall cabinets and cooker hoods must be fitted a minimum of 787mm directly above the top of the hotplate and 400mm above the hotplate when fitted in line with the outside of the appliance. If the units are intended to be fitted adjacent to the appliance but less than 400mm above the hotplate, then a minimum space of 100mm must be maintained between the sides of the unit and the appliance (see fig.). Curtains must not be fitted immediately behind the appliance or within 150mm of the sides of the hotplate. If fitted next to or between two base units a minimum space of 1mm must be left between each unit and the side of the appliance. The levelling feet fitted to the appliance will achieve a nominal height to hotplate trims of 900mm +20mm.

# Installation

## Positioning the Appliance (Fig. 1)



**This appliance cannot be positioned on a base.**

The appliance cannot be installed beside or between furniture units whose height exceeds the cooker worktop.

Note A:

The appliance is designed to be flush fitted with 2mm clearance at each side to allow for it to be pulled forward for cleaning etc.

Note B:

The hotplate side trims should be flush with the cabinets and must not be below. Adjustable levelling feet at the front and rear are provided on the base of the appliance. Adjustment is obtained by rotating in or out, the feet at the front or rear of the appliance from the underside of the appliance.

A spirit level should be placed on a cake tray on one of the shelves to confirm that the appliance is correctly levelled.

The levelling feet fitted to the appliance will achieve a height to hotplate trims of 900mm-0 + 10.

Note C:

If the appliance is fitted next to a side wall or cabinets above height of the hotplate trims, then a gap of 115 mm is required.

Curtains must not be fitted immediately behind the cooker or within 115 mm of the sides of the cooker.

Note D:

Any wall cabinet or extractor must not be lower than 780mm above hotplate level.

Note E:

Wall cabinets may be fitted in line with the sides of the base units, providing that the lower edge of the wall cabinet is a minimum of 420mm above the worktop.

L.P.G. cookers MUST NOT be installed below ground level, i.e. in a basement, or aboard any boat, yacht or other vessel.

For appliances installed in the Republic of Ireland please refer to NSAI- Domestic Gas Installation I.S 813 Current Edition Section 7- Permitted Locations of Appliance.

## Positioning the Cooker

Caution:

Some soft or badly fitted floor coverings can be damaged when the cooker is moved across their surface for cleaning. It is advisable to ensure that the floor covering in the area below the cooker is either securely fixed so as not to become damaged when the cooker is moved or, if preferred, removed.

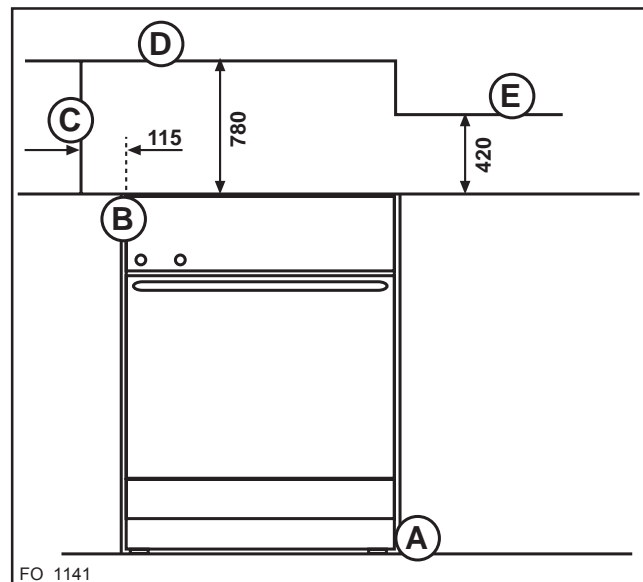

Fig. 1

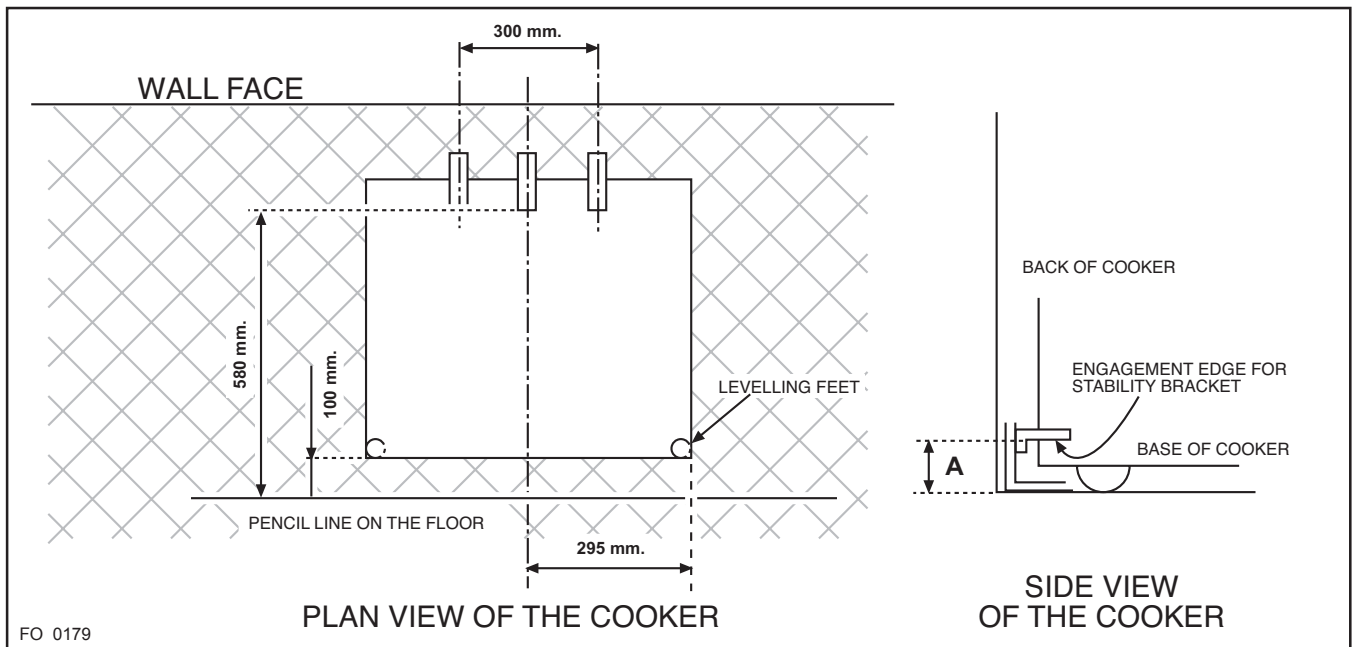

Fig. 2

## Fitting the Stability Bracket (Not supplied)

If the cooker has to be installed with a flexible supply pipe, it is necessary that a stability device is fitted. (See "Important Safety Requirements").

The stability bracket should be fitted by the installer and these instructions should be read in conjunction with the leaflet packed with the stability bracket.

Place cooker in its intended position and level cooker.

Mark off 295mm (11 1/2") from the right hand side of the cooker as shown, this is the centre line of the bracket fixing.

Draw a line 100mm (4") from the front edge of the levelling feet (see Fig. 1) and remove cooker from its position. Mark off 580mm (23") back from this line on the centre line of the bracket to locate the front edge of the lower bracket.

Fix lower bracket (with two fixing holes) to the floor, then measure height from floor level to engagement edge on back of cooker, dimension 'A' of Fig. 2.

Assemble upper bracket to lower bracket so that underside of bracket is dimension 'A' +3mm (1/8") above floor level. Re-position cooker and check that top bracket engages into cooker back to a depth of 75mm (3"), as shown in Fig. 2.

Should the stability bracket currently installed not allow the cooker to stand correctly, ask the installer to replace it with the correct type.

## Connecting to Gas

This cooker is designed to be installed with an appliance flexible connection. Connection is made to the RC 1/2 (1/2" B.S.P.) threaded entry pipe located just below the hotplate level on the rear right-hand side of the cooker. Check for gas soundness after connecting the gas supply.

The gas bayonet connector must be fitted in the shaded area indicated in Fig. 3. Take into account that it must be possible to pull the cooker forward sufficiently. The hose must not get caught on the stability bracket.

### Note:

If using different types of gas bayonet connection, it may not be possible for the appliance to be pushed fully back to the wall stops.

### Important:

Flexible tubing MUST comply with BS.669 Current Edition.

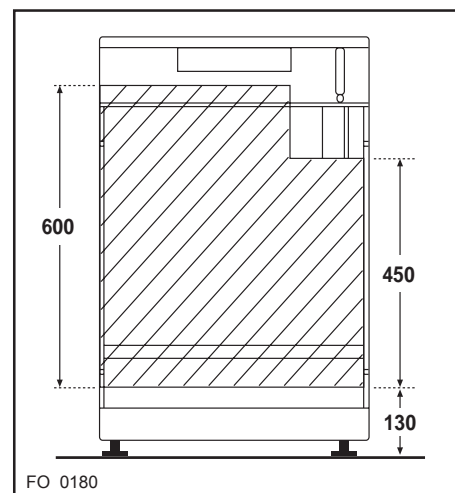

Fig. 3



# Electrical connections



Any electrical work required to install this hob should be carried out by a qualified electrician or competent person, in accordance with the current regulations.



**THIS COOKER MUST BE EARTHED.**

The manufacturer declines any liability should these safety measures not be observed.

**This cooker is designed to be connected to a 230 V 50 Hz AC electrical supply.**

Before switching on, make sure the electricity supply voltage is the same as that indicated on the hob rating plate. The rating plate is located on the bottom of the hob. A copy is attached on the back cover of this book.

The cooker is supplied with a 3 core flexible supply cord.

The cooker should be connected to a double pole switch with a minimum gap of 3mm between the switch contacts and of a type suitable for the required load in compliance with the current electric regulations. The switch should be sited within 2m of the hob and be easily accessible upon completion of the installation.

The switch must not break the yellow and green earth cable at any point.

## NOTE:

The earth wire should be about 2 cm longer than the live and neutral wires.



**Ensure that the hob supply cord does not come into contact with surfaces with temperatures higher than 50 deg. C.**

## Supply Cable Specifications

### For Uk use only

Connection via	Min. size Cable/flex	Cable / flex type	Fuse
• Cooker Control Circuit	6 mm <sup>2</sup>	H05 VV-F	30 A

### For Europe use only

Min. size Cable/flex	Cable / flex type	Fuse
3x 2.5 mm <sup>2</sup>	H05 RR-F H05V2V2-F	30 A

# Commissioning

When the hob has been fully installed it will be necessary to check the minimum flame setting. To do this, follow the procedure below.

- Turn the gas tap to the MAX position and ignite.
- Set the gas tap to the MIN flame position then turn the control knob from MIN to MAX several times. If the flame is unstable or is extinguished follow the procedure below.

## Procedure:

- Re-ignite the burner and set to MIN.
- Remove the control knob. According to the different gas tap versions, the adjustment screw can be located down the centre of the gas tap control shaft or on the gas tap body itself (see diagram).
- To adjust, use a thin bladed screwdriver and turn the adjustment screw until the flame is steady and does not extinguish, when the knob is turned from MIN to MAX. Repeat this procedure for all burners.

## Pressure Testing

- Remove left hand pan support and front left burner cap and crown.
- Fit manometer tube over the injector.
- Turn on the burner gas supply and ignite another burner supply.
- The pressure reading should be nominally 20mbar and must be between 17 mbar and 25mbar.
- Turn off the burner supplies.

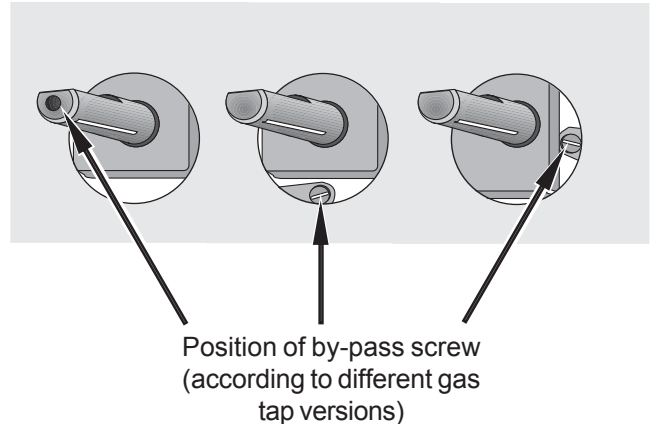

# Conversion from Natural Gas to LPG

It is important to note that this model is designed for use with natural gas but can be converted for use with butane or propane gas providing the correct injectors are fitted and the gas rate is adjusted to suit.

## Method

- Ensure that the gas taps are in the 'OFF' position
- Isolate the appliance from the electricity supply
- Remove all pan supports, burner caps, rings, crowns and control knobs.
- With the aid of a 7mm box spanner, the burner injectors can then be unscrewed and replaced by the appropriate LPG injectors (see Technical Data).

## To adjust the gas rate

With the aid of a thin bladed screwdriver completely tighten down the by pass adjustment screw. Upon completion, stick the replacement gas type label on the back plate of the appliance.

### IMPORTANT

The replacement/conversion of the appliance should only be undertaken by a competent person

-	ES	DA	DE	EL	EN	FR	IT	NL	PT	SV	FI	ZANUSSI 25 December
1	Fabricante	Mærke	Hersteller	Προμηθευτής	Manufacturer	Fabricant	Costruttore	Fabrikant	Fabricante	Leverantör	Tavarantoimittaja	ZCM 650/651
2	Modelo	Model	Modell	Μοντέλο	Model	Modèle	Modello	Model	Modelo	Modell	Malli	ZCM 650/651
3	Clase de eficiencia energética	Relativt energiforbrug	Energieeffizienzklasse	Τάξη ενεργειακής απόδοσης	Energy efficiency class	Classement selon son efficacité énergétique	Classe di efficienza energetica	Energie-efficiëntieklasse	Classe de eficiência energética	Energieeffektivitetsklass	Energiatehokkuusluokka	<b>A</b>
4	- Calentamiento convencional	- Traditionel opvarmning	- Konventionelle Beheizung	- Συμβατική	- Conventional	- Classique	- Convezione naturale	- Conventioneel	- Convencional	- Konventionell värming	- Ylä-alalämpö	
5	- Convección forzada	- Varmiluft	- Um/Heißluft	- Με κυκλοφορία θερμού αέρα	- Forced air convection	- Convection forcée	- Convezione forzata	- Geforceerde luchtconvector	- Convecção forçada de ar	- Värmning med varmluft	- Kiertoilma	←
	Consumo de energía Función de calentamiento:	Energiforbrug Opvarmningsfunktion:	Energieverbrauch Beheizung:	Κατανάλωση ενέργειας Αιτούργια θέρμανσης	Energy consumption Heating function:	Consommation d'énergie Fonction chauffage:	Consumo di energia Funzione di riscaldamento:	Energieverbruik Verhittingsfunctie:	Consumo de energia Função de aquecimento:	Energiförbrukning Värmningsfunktion:	Energiankulutus Kuunnustapa:	
6	- Calentamiento convencional	- Traditionel opvarmning	- Konventionelle Beheizung	- Συμβατική	- Conventional	- Classique	- Convezione naturale	- Conventioneel	- Convencional	- Konventionell värming	- Ylä-alalämpö	0,79 kWh
7	- Convección forzada	- Varmiluft	- Um/Heißluft	- Με κυκλοφορία θερμού αέρα	- Forced air convection	- Convection forcée	- Convezione forzata	- Geforceerde luchtconvector	- Convecção forçada de ar	- Värmning med varmluft	- Kiertoilma	0,78 kWh
8	- Vapor	- Damp	- Dampf	- Ατμός	- Steam	- Vapeur	- Vapore	- Stoom	- Vapor	- Ånga	- Höyry	
9	Volumen neto (litros)	Nettovolumen (liter)	Nettovolumen (Liter)	Ωφέλιμος όγκος (λίτρα)	Usable volume (litres)	Volume utile (litres)	Volume utile (litri)	Netto volume (liter)	Volume útil Litros	Användbar volym (liter)	Käyttötilavuus (litraa)	56
	Tipo: - Pequeño - Medio - Grande	Type: - Lille - Mellemstort - Stort	Typ: - Klein - Mittel - Groß	Τύπος: - Μικρός - Μεσαίος - Μεγάλος	Size: - Small - Medium - Large	Type: - Faible volume - Volume moyen - Grand volume	Tipo: - Piccolo - Medio - Grande	Type: - Klein - Middelgroot - Groot	Tipo - pequeno - médio - grande	Storlek: - Liten - Medelstor - Stor	Koko: - Pieni - Keskipikoinen - Suuri	←
	Tiempo de cocción con carga normal:	Tilberedningstid ved standardbelastning:	Kochzeit bei Standardbelastung:	Χρόνος για ψησιμο τυποποιημένου φορτίου.	Time to cook standard load:	Temps de cuisson en charge normale:	Tempo necessario per cottura carico normale:	Bereidings-tijd bij standaardbelasting:	Tempo de cozedura da carga-padrão:	Tillagningstid för en standardlast:	Paistoaika vakiokuormalla:	
10	- Calentamiento convencional	- Traditionel opvarmning	- Konventionelle Beheizung	- Συμβατική	- Conventional	- Classique	- Convezione naturale	- Conventioneel	- Convencional	- Konventionell värming	- Ylä-alalämpö	43 min.
11	- Convección forzada	- Varmiluft	- Um/Heißluft	- Με κυκλοφορία θερμού αέρα	- Forced air convection	- Convection forcée	- Convezione forzata	- Geforceerde luchtconvector	- Convecção forçada de ar	- Värmning med varmluft	- Kiertoilma	41 min.
12	Superficie de la placa de cocción de mayor tamaño	Arealet af den største bageplade	Größe des größten Backblechs	Η μεγαλύτερη επιφάνεια ψησίματος εκφραζόμενη	The area of the largest baking sheet	Aire de la surface de la plus grande plaque pour pâtisserie	Superficie del piano di cottura più grande	Oppervlakte van de grootste bakplaat	Área da superfície da maior placa de pastelaria	Ytan för den största bakplaten	Suurimman leivinpellin ala	1130 cm <sup>2</sup>
13	Ruido [dB (A) re 1 pW]	Lydeffektniveau dB (A) (Støj)	Geräusch (dB (A) re 1 pW)	Ήχος [dB (A) ανά 1 pW]	Noise (dB (A) re 1 pW)	Bruit [dB (A) re 1 pW]	Rumore [dB (A) re 1 pW]	Geluidsniveau dB (A) re 1 pW	Nível de ruído dB (A) re 1 pW	Bullemlivå dB (A)	Ääni (dB (A) re 1 pW)	
<p>● Más eficiente / Bassi consumi / Efficient / Niedriger Verbrauch / Mais efficace / Προσδοτικό / Låg förbrukning / More efficient / Vähän kuluttava / Econome</p> <p>● Menos eficiente / Højt forbrug / Inefficient / Hoher Verbrauch / Menos eficiente / Ανεπάρκεια απόδοσης / Less efficient / Paljon kuluttava / Peu économe</p> <p>●● 12 l ≤ Volumen neto/Nettovolumen/Ωφέλιμος όγκος/Usable volume/Volume utile/ Netto volume/Volume útil/Användbar volym/Käyttötilavuus &lt; 35 l</p> <p>●●● 35 l ≤ Volumen neto/Nettovolumen/Ωφέλιμος όγκος/Usable volume/Volume utile/ Netto volume/Volume útil/Användbar volym/Käyttötilavuus &lt; 65 l</p> <p>●●●● 65 l ≤ Volumen neto/Nettovolumen/Ωφέλιμος όγκος/Usable volume/Volume utile/ Netto volume/Volume útil/Användbar volym/Käyttötilavuus</p>												
2002/40/EC												

## CUSTOMER CARE

### Zanussi-Electrolux

Cornwall House  
55-77 High Street  
Slough  
Berkshire  
SL1 1DZ  
08705 727727 (\*)

© Electrolux plc 2004

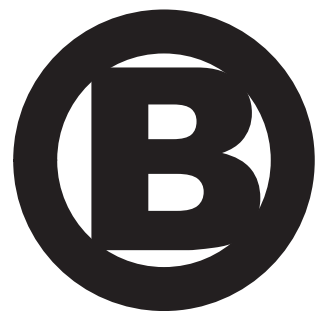

 **From the Electrolux Group. The world's No.1 choice.**

*The Electrolux Group is the world's largest producer of powered appliances for kitchen, cleaning and outdoor use. More than 55 million Electrolux Group products (such as refrigerators, cookers, washing machines, vacuum cleaners, chain saws and lawn mowers) are sold each year to a value of approx. USD 14 billion in more than 150 countries around the world.*

## Free Manuals Download Website

<http://myh66.com>

<http://usermanuals.us>

<http://www.somanuals.com>

<http://www.4manuals.cc>

<http://www.manual-lib.com>

<http://www.404manual.com>

<http://www.luxmanual.com>

<http://aubethermostatmanual.com>

Golf course search by state

<http://golfingnear.com>

Email search by domain

<http://emailbydomain.com>

Auto manuals search

<http://auto.somanuals.com>

TV manuals search

<http://tv.somanuals.com>