

OPERATING AND INSTALLATION INSTRUCTIONS

ZANUSSI

DUAL FUEL
COOKER

MODEL
ZCM ID

Introduction

This gas oven has been designed and manufactured to all the necessary British Standards. It also carries the C.E. mark. The cooker complies with European Council Directive 90/396/EEC.

It is important that you understand how to use and care for the oven properly before you use it for the first time.

We have written this booklet with your safety in mind. Read the booklet thoroughly before you use the oven. Keep the booklet in a safe place so that anyone who uses the oven can read it. Pass the booklet on with the oven if you give or sell it to someone else.

For your safety

This oven is designed for domestic use to cook food. You must not use it for any other purpose. It is not designed for commercial use.

Keep children, babies and toddlers away from the oven at all times.

The installation instructions that came with the oven tell you how and where it can be fitted. If the oven is already installed you must make sure that all instructions have been followed. If you are in any doubt ask a registered person. More details on installation on page 36.

We have included several drawings to show the right and wrong way of doing things.

The right way will have a smiling face by it.



A sad face shows something is wrong.



Do not remove the rating plate from the cookers as this may invalidate the guarantee.

Contents	Page
Lighting the cooker	4
The grill	7
The hotplate	10
The ovens	13
Oven cooking charts - Main fan oven	17
Roasting chart	20
- Second oven	21
Defrost feature	24
Things to note	25
The electronic timer	26
Care and cleaning	30
Installing the cooker	36
General information	38
What is wrong and why?	40
Service and spare parts	42
Customer care department	43
Guarantee conditions	44
Technical data	45
Safety requirements/ventilation	46
Location of appliance	46
Location of storage board	47
Installation	48
Testing	50

Lighting the cooker

The system works by means of an electric spark system. Details about the plug are given on page 38.

Hotplate

To light

1. Lift up the lid. You cannot use the hotplate when the lid is down.
2. Push in the control knob and turn it to the the large flame symbol (highest setting), and press the ignition button immediately. When the burner has lit release the button.

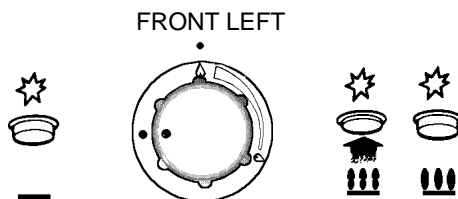

Warning: If the ignition button is not pressed immediately a build up of gas may cause the flame to spread.

For your safety

If you close the lid of the cooker while any of the hotplate burners are lit the gas will go out. This is because it would be dangerous if the burners stayed on when the lid was closed.

Always use the control knob to turn off a burner. Do not use the lid as a cut-off device. This will only cut off the gas when the lid is closed. The gas will flow again when the lid is opened.

Please note: If you have any trouble lighting a hotplate burner turn all the hotplate control knobs off and make sure the hotplate burner parts have been replaced correctly.

See page 31 for more information.

Grill/second oven

The grill and the second oven are operated by the same control so you cannot use them both at the same time.

To light:

- 1 Open the door.
- 2 Push in the control knob and turn it to the large flame symbol (highest setting), and press the ignition button immediately. When the burner has lit release the button.



- 3 Leave the grill door open when you are using the grill.

Warning: If the ignition button is not pressed immediately a build up of gas may cause the flame to spread.

For your safety

Never cover the grill pan or grid with foil as this can lead to grill fires.

Second oven

To light:

- 1 Open the oven door.
- 2 Push in the control knob and turn it to the left to gas mark 1. Press the ignition button. When the burner has lit release the button. There will only be small flames at first.

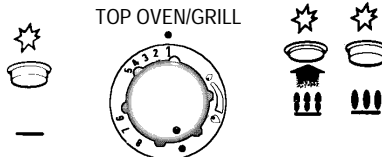

- 3 Now turn the control knob to the gas mark you want.
- 4 Wait until the burner is showing large flames.
- 5 Close the oven door.



Important: Remember to remove the grill pan handle before you use the second oven.

To turn off any burner

- 1 Push in the control knob and turn it to the off position. This is shown by a large dot.

TOP OVEN/ GRILL

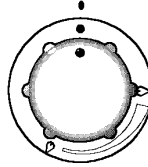
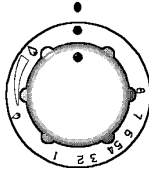

For your safety

When you are lighting any burner check that it has lit before you leave the cooker.

When you are turning off a burner, do not leave the cooker until the flame has gone out.

Main fan oven

The main oven is an electric fan oven.

To use the oven

- 1 Turn the oven control knob to the required setting.
The oven light will come on when you turn the control knob. The light will go out when you turn the oven control off. If you need to replace the oven light bulb follow the instructions given on page 39.

MAIN OVEN

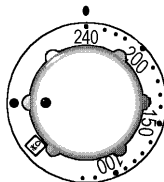

To turn off the oven

- 1 Turn the oven control knob to the off position. This is shown by a large dot.

MAIN OVEN

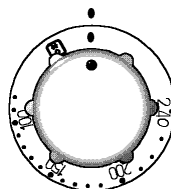

The grill

The grill is a high-speed grill. The instructions below tell you how to vary the heat setting and how to change the height of the grid to suit the food you are cooking. You should remember to turn the food regularly.

You should not use the grill to keep food warm as it will continue to cook the food.

For your safety

You must keep the grill door open when the grill burner is lit.

Accessible parts may be hot when the grill is used. Young children should be kept away.

Never cover the grill pan or grid with foil as this can lead to grill fires.

Heat control

The grill control has two heat settings.

The control knob turns to the left from 'OFF' to 'HIGH' and then to 'LOW'. Use the high setting for fast cooking such as toast. Use the low setting to cook thicker food such as chicken after you have browned it on the high setting.

TOP OVEN/ GRILL

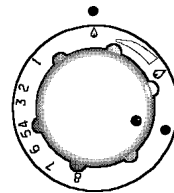

Cooking positions

Most food should be cooked on the grid in the grill pan. You can turn the grid over to suit different thicknesses of food.

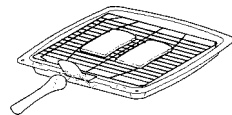

You can place some dishes straight on the grill shelf. This is useful when you are browning the top of food such as cauliflower cheese.

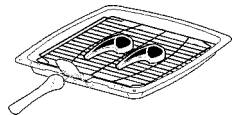

General

Plate warming

You can use the grill compartment to warm plates when you are using the oven.

Preheating

You don't usually need to preheat the grill. You may wish to preheat it for a couple of minutes when you are cooking steak or browning food.

Positioning food on the grid

Place food such as toast, tea-cakes and muffins towards the centre of the grid. If you put food outside this area it may require rotating during cooking.

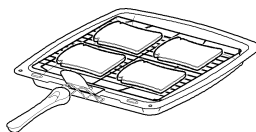

Place food which needs a more gentle heat, such as tomatoes and mushrooms towards the edge of the grid.

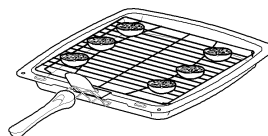

Arrange meat products and fish to suit their thickness and how you like them cooked.

To prevent excess fat splashing when you use the grill place the trivet in the grill pan below the grill grid.

Grill shelf

You should use the shelf without the metal plate when grilling. For safety the shelf will only pull out so far. If you want to remove a shelf completely, pull it forward as far as it will go, raise the front edge and lift it out. To put the shelf into a different position, keep the front edge raised, slot the shelf onto the runner, lower the front edge and slide the shelf in.

The grill pan and handle

The grill pan is supplied with a removable handle.

To attach the handle, place the wirework under the cut out in the pan so that the metal plate hooks over the top of the grill pan.

Slide the handle to the left and over the central bump on the grill pan.

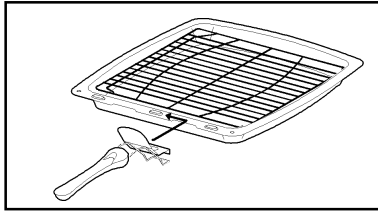

Ensure the handle is correctly located. It is not necessary to remove the grill pan handle during grilling.

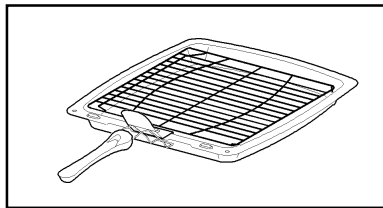

Place the grill pan on the shelf so that the pan is positioned centrally beneath the grill.

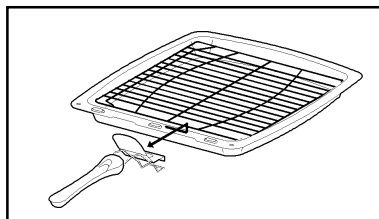

To remove the handle, slide the handle to the right and lift the handle away from the cut out on the grill pan.

If you require an additional handle for your grill pan, this can be ordered from your local Zanussi Service Force Centre by quoting part number 311479800\6.

The hotplate

You can only use the hotplate when the lid is open. If you have any trouble lighting a hotplate burner turn all hotplate control knobs off and make sure the hotplate burner parts have been replaced correctly. See page 31 for more information.

Heat control

The hotplate control knobs turn to the left from 'OFF' to 'HIGH' and then to 'LOW'. You can adjust the heat by turning the control between the highest and lowest settings. These are shown as a large and a small flame symbol.

FRONT LEFT

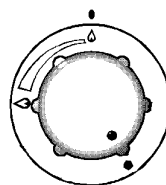

Burner sizes

The hotplate has three burner sizes to suit different types of cooking:

Largest burner - use a large pan for food such as chips.

Medium burners - use for everyday cooking.

Small burner - use for simmering food such as soups and stews.

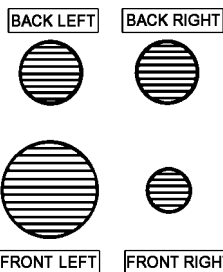



The largest pan which you should use on any burner is 230mm (9"). The base of the smallest pan should not measure less than 100mm (4").





For your safety







1 Take care to avoid burns and scalds when you are reaching across the hotplate.

2  Use pans with flat bases. They are more stable than pans which are warped. 

3  Do not use pans with very heavy handles which cause the pan to tip. 

4  Put pans on the centre of the burners. 

5  Position pan handles so they cannot be accidentally knocked. 

6  Take extra care when you are deep fat frying. Do not cover the pan with a lid. 

FRONT LEFT



Do not leave a pan unattended. If the pan catches fire, leave it where it is and turn off all controls.





Place a damp cloth or a fitting lid over the pan to smother the flames.

Never put water on the fire.



Leave the pan to cool for 30 minutes.











7  If you are using a Wok we recommend it has a flat base as it will stand stable on the pan supports. If you use a round based Wok with a collar support, the collar must be of the open wire work type. A closed collar will affect the performance of the burner. Before you use the Wok make sure that the collar is stable on the pan supports.  Always follow the instructions that come with the Wok.

8 Do not use the lid as a work surface or chopping board. this could damage the glass and reduce its strength.

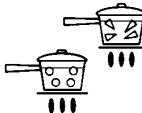

Helpful hints



- 1  Keep flames under the base of pans. If the flames lick round the sides of the pans you are wasting gas. 
- 2  Only heat the amount of liquid you need. Do not overfill pans. 
- 3  Cover pans with a lid whenever possible. The food will heat up more quickly and there will be less steam in the kitchen. 
- 4  Try cooking more than one vegetable in the same pan, for example potatoes and carrots. 
- 5  Cut vegetables into smaller pieces. This way they will cook more quickly. 
- 6  A pressure cooker will save time and energy.

The fan oven

Before you use the oven you should wipe it out with a damp cloth to remove any dust.

We suggest to run the oven for 10-15 minutes at 200°C to burn off any residue from surfaces. During this period an odour may be emitted, it is therefore advisable to open a window for ventilation.

The fan circulates hot air in the oven to give an even temperature throughout the oven. You can make use of the even temperature when you want to cook a large quantity of similar foods at the same time. For example, if you are cooking more than one tray of cakes or biscuits there is no need to swap the trays around during cooking.

Preheating

You do not need to preheat the oven when casseroles and so on.

If you do not preheat the oven you may need to add an extra five or ten minutes on the recommended cooking times.

Preheat the oven for baking or when you are cooking sensitive food such as Yorkshire puddings, pastries, scones, soufflés and yeast mixtures.

When you are cooking or reheating frozen or chilled food read the instructions on the packing.

When you need to preheat the oven, we recommend you do so for 10 minutes.

Cooking temperatures

Fan oven cooking generally requires lower temperatures than conventional cooking. You should pay particular attention to cooking times and temperature settings as these may differ from your previous cooker.

Follow the temperatures recommended in the cooking charts on pages 17 - 23. As a guide reduce temperatures by about 20° - 25°C for your own conventional oven recipes.

If you do not follow the recommended temperatures uneven browning may result.

Batch baking

The fan oven cooks evenly on all shelf levels. This is especially useful when you want to batch bake on three shelves. Make sure the shelves are evenly spaced to get the best results.

Oven shelves

You can slot the oven shelves in any of five positions. When you are using more than one shelf, make sure the shelves are evenly spaced.

For safety the shelf will only pull out so far. If you want to remove a shelf completely pull it forward as far as it will go, raise the front edge and lift it out. To put the shelf into a different position keep the front edge raised, slot the shelf on to the runner, lower the front edge and slide the shelf in.

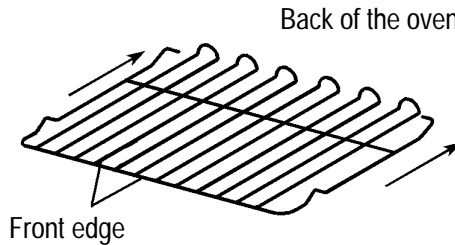

Baking trays and dishes

Place baking trays and dishes in the centre of the shelf. You must not place bakeware against the grid covering the fan at the back of the oven.

For the best results we recommend that you use a baking tray which is no larger than 300mm x 350mm (12" x 14"). If you use a tin or tray which is larger than this the circulation of heat will be restricted and may affect performance.

Enamelware, dark, heavy or non-stick trays and dishes increase base browning of food. Shiny aluminium or polished steel trays reflect heat and food browns less on the underside.

The gas top oven

Before you use the oven you should wipe it out with a damp cloth to remove any dust.

You can only cook on one shelf at a time. You should turn food round during the cooking time.

Preheating

You do not need to preheat the top oven for casseroles and so on.

Preheat the oven for baking or when you are cooking sensitive food such as Yorkshire puddings, soufflés and yeast mixtures.

When you are cooking or reheating frozen or chilled food read the instructions on the packaging. When you are using the top oven to cook or reheat convenience food you should preheat the oven to gas mark 8.

When you need to preheat the oven, we recommend you do so for 20 minutes.

Oven shelves

The shelf in the top oven is different from the shelves in the main oven. You can distinguish the top oven shelf from the main oven shelves because it has a metal plate attached to it. The shelves provided for the main oven should only be used in the main oven. Similarly, only use the top oven shelf in the top oven.

Shelf positions are counted from the top downwards.

Most top oven cooking should be carried out using the shelf provided in shelf position 2. However, when cooking a small joint or a deep cake you can use the top oven shelf on the base of the top oven to allow enough air to circulate around the food.

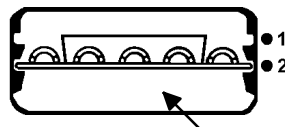

Shelf on base

Roasting

For best results we recommend open roasting, with or without a trivet using minimal fat or oil to prevent splashing.

It is not necessary to cover meat or poultry or wrap food in foil when roasting as this restricts the circulation of heat and will lead to extended cooktimes.

If you are using a roasting bag or cover chicken breast with foil, be prepared to allow an extra 10 - 15 minutes for each 1/2kg (1lb).

When cooking large items such as turkeys, the use of foil may be required to prevent the breast becoming dry before the rest of the bird is fully cooked.



Helpful hints



1. Arrange the oven shelves in the required positions before switching the oven on.
2. Place dishes centrally on different shelves rather than cluster several dishes on one shelf.
3. When baking larger quantities of food, the shelf positions should be evenly spaced. A slight increase in cooking time may be necessary.
4. Do not place dishes or baking trays on the oven base as this may restrict the circulation of heat. However, when more space is required, non critical dishes can be placed on the oven base.

Condensation

Condensation may form on the cooker. This is quite normal and nothing to worry about. The condensation forms when heat and moisture are present, for example during cooking. Whenever possible try to make sure that food which contains a lot of moisture, for example casseroles, are covered. If you do notice any condensation, wipe it up straight away.

Oven Cooking Chart - Main fan oven

The oven temperatures are intended as a guide only. It may be necessary to increase or decrease the temperatures by 10°C to suit individual preferences and requirements.

Shelf positions are not critical but ensure that oven shelves are evenly spaced when more than one is used.

Food	Cooking temp (°C)	Approximate cooking time (m)
Biscuits	180 - 190	10 - 20
Bread	200 - 220	25 - 30
Bread rolls/buns	200 - 220	15 - 20
Cakes	160 - 170	18 - 25
Small & Queen Sponges	160 - 170	18 - 20
Victoria Sandwich	160 - 170	18 - 25
Madeira	140 - 150	1¼ - 1½ h
Rich Fruit	130 - 140	2¼ - 2½ h
Christmas	130 - 140	3 - 4½ h
		depends on size
Gingerbread	140 - 150	1¼ - 1½ h
Meringues	80 - 100	2½ - 3 h
Flapjack	170 - 180	25 - 30
Shortbread	130 - 140	45 - 65

Food	Cooking temp (°C)	Approximate cooking time (m)
Casseroles	140 - 160	2½ - 3 h
Beef/lamb	180 - 190	1¼ - 1½ h
Chicken	Follow manufacturer's instructions	
Convenience Foods	170 - 190	20 - 30
Fish	190 - 200	20 - 25
Fish Pie (Potato Topped)	190 - 200	40 - 50
Fruit Pies, Crumbles	130 - 140	1½ - 2 h
Milk Puddings	190 - 200	40 - 45
Pasta, Lasagne etc.	190 - 200	30 - 35
Pastry:	170 - 180	20 - 30
Choux	210 - 220	25 - 40
Eclairs, Profiteroles	190 - 200	15 - 20
Flaky/Puff Pies	190 - 210	25 - 35
Mince Pies	180 - 210	25 - 45
Meat Pies	150 - 160	1 - 1½ h
Quiche, Tarts, Flans	160 - 180	see roasting chart
Patés and Terrines	210 - 220	8 - 10
Roasting Meat, Poultry	190 - 200	30 - 40
Scones	170 - 180	20 - 30
Shepherd's Pie		
Soufflés		

Food	Cooking temp (°C)	Approximate cooking time (m)
Vegetables:	Baked Jacket Potatoes	1 - 1½ h
	Roast Potatoes	1 - 1½ h
Yorkshire Puddings:	Stuffed Marrow	30-35
	Stuffed Tomatoes	15-20
	Large Individual	25-40
	200 - 210	15-25

Roasting chart

MEAT	TEMPERATURE	COOKING TIME
Beef	160 - 180°C	20 - 35 min per ½kg/1lb and 20 - 35 min over
Beef, boned	160 - 180°C	20 - 35 min per ½kg/1lb and 25 - 35 min over
Mutton and Lamb	160 - 180°C	25 - 35 min per ½kg/1lb and 25 - 35 min over
Pork and Veal	160 - 180°C	30 - 40 min per ½kg/1lb and 30 - 40 min over
Ham	160 - 180°C	30 - 40 min per ½kg/1lb and 30 - 40 min over
Chicken	160 - 180°C	15 - 20 min per ½kg/1lb and 20 min over
Turkey and Goose	160 - 180°C	15 - 20 min per ½kg/1lb up to 3½kg/7lb then 10 min per ½kg/1lb over 3½kg/7lb
Duck	160 - 180°C	25 - 35 min per ½kg/1lb and 25 - 30 min over
Pheasant	160 - 180°C	35 - 40 min per ½kg/1lb and 35 - 40 min over
Rabbit	160 - 180°C	20 min per ½kg/1lb and 20 min over
Potatoes with meat	160 - 180°C	according to size
Potatoes without meat	180 - 190°C	according to size

The roasting temperatures and times given in the chart should be adequate for most joints, but slight adjustments may be required to allow for personal requirements and the shape and texture of the meat. However, lower temperatures and longer cooking times are recommended for less tender cuts or larger joints.

Wrap joints in foil if preferred, for extra browning uncover for the last 30 - 60 min. cooking time.

INTERNAL TEMPERATURES

Rare : 50 - 60°C; Medium: 60 - 70°C; Well done: 70 - 80°C

Oven cooking chart - Second oven

These instructions are for cooking in the oven after it has been pre-heated for 20 minutes.

The recommended shelf positions give the best results.

Put the dishes centrally on the shelf and turn food round during the cooking time.

You can change the gas marks and cooking times to suit your own tastes.

It is important to check that food is piping hot before serving.

If you are using both ovens at the same time you may need to adjust the cooking times.

Food	Gas mark	Shelf position	Approximate cooking time
Roasting meat:	5	Shelf on oven base	Rare: 20 mins. per ½ kg (1lb) and 30 mins. Medium: 25 mins. per ½ kg (1lb) and 25 mins. Well Done: 30 mins. per ½ kg (1lb) and 30 mins.
		Shelf on oven base	Medium: 25 mins. per ½ kg (1lb) and 25 mins. Well Done: 30 mins. per ½ kg (1lb) and 30 mins.
		Shelf on oven base	Medium: 30 mins. per ½ kg (1lb) and 30 mins. Well Done: 35 mins. per ½ kg (1lb) and 35 mins.
Pork and Veal	5	Shelf on oven base	Medium: 30 mins. per ½ kg (1lb) and 30 mins. Well Done: 35 mins. per ½ kg (1lb) and 35 mins.

Thaw frozen joints thoroughly before cooking them.

Food	Gas mark	Shelf position	Approximate cooking time
Poultry:			
Chicken	5	Shelf on oven base	20 mins. per ½kg (1lb) and 20 mins.
Duck and duckling	5	Shelf on oven base	25 mins. per ½kg (1lb).
Stuffed poultry	Cook as above but calculate weight including stuffing.		
Thaw frozen joints thoroughly before cooking them.			
The times given above are for open roasting in a preheated oven. If you cover the food with foil or a lid allow an extra 10 - 15 minutes for each ½kg (1lb).			
Yorkshire pudding - individual	7	2	20 - 30 mins.
Cakes:			
Christmas cake (7")	2	Shelf on oven base	3 - 4 hours
Rich fruit, 180mm (7")	2	on oven base	2 - 2½ hours.
Madeira, 180mm (7")	4	1 hour.	
Small cakes	5	2	15 - 25 mins.
Scones	7	2	8 - 12 mins.
Victoria Sandwich (7")	4	2	20 - 30 mins.
Pastries:			
Plate tart (shortcrust)	6	2	25 - 35 mins.
Fruit pie (shortcrust)	6	2	25 - 35 mins.
Mince pies (flan pastry)	5	2	15 - 25 mins. and have no rim underneath, place on baking tray.

Food	Gas mark	Shelf position	Approximate cooking time
Milk pudding	2	2	2 hrs. approx.
Baked sponge pudding	3	2	45 - 60 mins.
Baked custard	3	2	50 - 60 mins.

Note: You must soak dried beans then boil them in an open pan for 15 minutes before you add them to any dish.

Defrost feature

Uses of defrost feature

This fan oven function defrosts most foods faster than more conventional methods. It is particularly suitable for delicate frozen foods which are to be served cold e.g. cream filled gateaux, cakes covered with icings or frostings, cheesecakes, biscuits, scones, etc.

It is preferable to thaw fish, meat and poultry slowly in the fridge. However this process can be accelerated by using the defrost function.

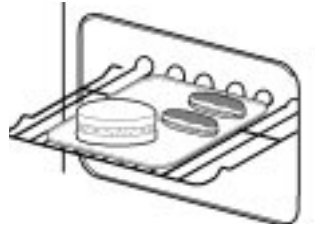

Small or thin fish fillets, frozen peeled prawns, cubed or minced meat, liver, thin chops, steaks etc., can be thawed in 1 - 2 hours.

A 1kg/2¼lb oven ready chicken will be thawed in approximately 5 hours. Remove the giblets as soon as possible during the thawing process. Joints of meat up to 2kg/4½lb in weight can be thawed using the defrost function.



ALL JOINTS OF MEAT AND POULTRY MUST BE THAWED THOROUGHLY BEFORE COOKING.

ALWAYS COOK THOROUGHLY IMMEDIATELY AFTER THAWING.

Selecting defrost

Turn the main oven temperature control to the defrost setting.

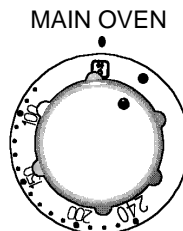

Things to note

When defrost is selected, the oven indicator neon may come ON. It will stay ON until the oven reaches room temperature and then go OFF. It may cycle ON and OFF periodically during defrosting to maintain a steady room temperature, inside the oven.

Care must always be taken when handling foods in the home. Always follow the basic rules of food hygiene to prevent bacterial and microbial growth and cross contamination when defrosting, preparing, cooking, cooling and freezing foods.

Hints and tips

Place the frozen food in a single layer where possible and turn it over half way through the defrosting process.



The actual speed of defrosting is influenced by room temperature. On warm days defrosting will be faster than on cooler days.

DO NOT leave food at room temperature once it is defrosted. Cook raw food immediately or store cooked food in the fridge.

The electronic timer

Please note that this is a 24 hour clock, for example 2.00 pm is shown as 1400.

In the following pages we explain how to set the controls. Read through them a few times until you are familiar with the procedure. We have supplied a plastic card as a quick reference when setting the timer.

Cookpot symbol Bell symbol

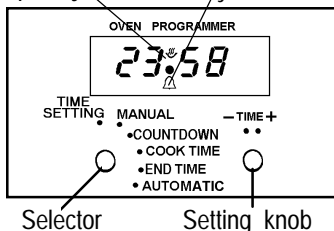

If the oven is switched off on the wall, or there is a loss of power, the clock will stop and you will not be able to use the main oven. When you first switch the electricity supply on, the timer display will flash.

To set the time of day

Turn the selector knob to 'manual' then turn to 'Time Setting'.

Set the correct time by turning and holding the setting knob clockwise. Adjust the time by turning the setting knob in either direction.

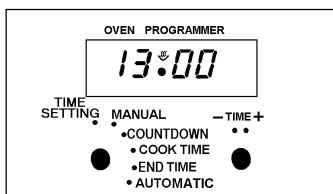

Turn the selector knob back to 'manual'.

To use the minute minder

Turn the selector knob to 'Countdown'. Turn the setting knob clockwise until the display shows the time you want. The bell symbol () will be showing and this will stay lit up during the time. Our diagram shows the timer set to 5 minutes.

If you change your mind and want to cancel the time you have set, simply turn the setting knob anticlockwise. Then turn the selector to 'manual'.

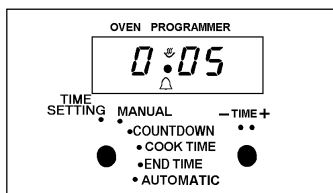

When you are using the 'Countdown' you can make the clock show the time of day by turning the selector knob to 'manual'. The bell symbol will stay on to remind you that the minute minder is set. At the end of the timed period an alarm will sound and the bell symbol will go out.

Switch off the alarm by turning the selector knob to Time Setting. Then turn to 'manual' and the time of day will show in the display.

Note:

You can use the 'Countdown' when an automatic sequence has been set, as long as you remember the following point.

- 1 Turn the selector knob to 'Automatic' as soon as you have entered the timed period into the display.

Automatic control

Important: You can only use the automatic control for the main oven.

When you use the automatic controls for the first time it's probably best to choose a time when you are at home. That way you can check to make sure you've set everything correctly and you'll feel much more confident when you are away from home in the future.

Setting the controls for automatic use

This is very easy. All you have to do is work through the steps below. The clock will work out the rest for itself.

1 Is the electricity supply on?

2 Is the clock showing the correct time?

To adjust turn the selector knob to 'manual' then turn to 'Time Setting'. Turn the setting knob in either direction.

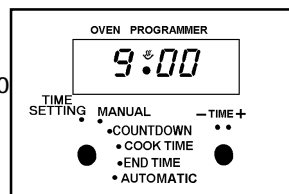

- 3 How long will the food take to cook? Turn the selector knob to 'Cook Time'. Then turn the setting knob until the length of time you want the food to cook shows in the display. The maximum cooking time is 10 hours. 'Auto' will show in the display.

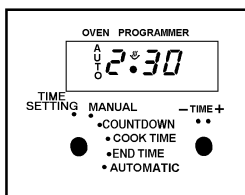

- 4 What time do you want the food to be cooked by? Turn the selector knob to 'End Time'. Turn the setting knob until the time the oven is to switch off shows in the display. The cookpot () will go out.

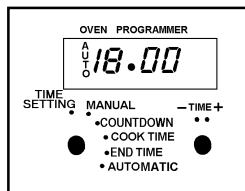

The 'End Time' must not be more than 23 hours 59 minutes from the time of day. For example if the time of day is 9.00 am the latest 'End time' will be 8.59 am the next day.

- 5 Set to automatic. Turn the selector knob to 'Automatic'.
- 6 Turn on the oven control. Turn the oven control knob to the required setting.

The time shown on the chart gives an example of setting the automatic controls when the time is 9.00 am, the food is to be cooked for 2½ hours and the food is needed at 6.00 pm (1800 hours).

The clock will work out what time the oven will switch itself on and it will turn the oven off at the end. Once the automatic sequence is finished there will be an alarm to remind you that you need to set the oven for manual operation. To do this turn the selector knob to 'manual'. Turn the oven control.

If you change your mind and want to cancel a programme that you have set simply turn to 'Time Setting' and then to 'manual'.

Hints and tips for automatic cooking

- 1 Check the instructions for setting the automatic controls until you are familiar with the timer operation.
- 2 If the oven has been used, allow it to cool completely before using for automatic cooking.
- 3 You should leave food in the oven for as short a time as possible before automatic cooking starts.
- 4 Do not leave food to stand in the oven when it has finished cooking. You should remove it and if it is not going to be eaten at once, cool it quickly.
- 5 If you cannot remove food from the oven as soon as it is cooked make sure that the food is covered.
- 6 Choose perishable foods carefully, especially during warm weather.
- 7 Food should be fresh and preferably straight from the refrigerator.
- 8 Joints of meat and poultry must be completely thawed.
- 9 Dishes containing left over cooked meat or poultry should not be cooked automatically if there is a delay period.
- 10 Choose dishes which require approximately the same cooking time. Slight variations may be allowed by:-
 - i) placing foods in larger or smaller containers
 - ii) using more or less liquid
 - iii) cutting fruit or vegetables into larger or smaller pieces.This will give longer or shorter cooking times respectively.
- 11 Arrange shelf positions to suit dishes and choose dishes which will fit into the oven together.
- 12 As food may be standing for some time in the oven, cover dishes with foil or a lid where possible, and in the case of roast potatoes and joints of meat, brush with a little fat or oil. Lemon juice may be added to fruit to prevent browning.
- 13 Cream should be added just before serving.
- 14 If alcohol is used fermentation can occur.
- 15 Green leaf vegetables which take only a short time to cook, should not be placed into the oven with the automatic meal. It is far better to cook them in a pan on the hotplate whilst dishing up the rest of the meal.

Care and cleaning

For your safety

For hygiene and safety reasons you must keep this cooker clean. A build up of fat or other foodstuff could cause a fire.

Try to mop up spills and splashes as soon as they happen. But be careful as parts of the cooker will be hot.

Do not use any polishes, caustic cleaners, abrasives, washing soda or soap powder except those recommended in this booklet.

Please note: If we recommend you use hot soapy water we mean hot water with washing up liquid in it and not any other cleaning product.

If you own a dishwasher please read the operating instructions for the machine before you wash any part of your cooker.

Clean your cooker regularly using a cloth that has been wrung out in hot soapy water. Rinse and polish it dry using a soft cloth.

Stainless Steel cream cleaners are abrasive and should be avoided as they may damage the surface finish.

Any spillage on the Stainless Steel finish must be wiped off immediately. To prevent streaking on Stainless Steel models finish with a soft cloth. When you remove parts of your cooker for cleaning do not plunge them into water whilst they are very hot as this may damage the finish of the parts.



The hotplate

Clean the hotplate top using a mild abrasive such as 'Jif'. Take care not to damage the spark electrodes. If the spark electrodes are damaged the burners will not light.

You can remove the pan supports, burner caps and burner crowns to clean them. Again take care not to damage the spark electrodes.

If any food spills during cooking you can place the pan on another burner to finish cooking. Then you can remove the dirty parts and clean them before the spill 'burns on'.

Clean the burner crowns by soaking them in very hot soapy water. You can remove any stubborn stains by scouring with a soap filled pad such as 'Brillo'. If you look after the burner crowns in this way they will stay reasonably clean. However the surface will dull with time.

Aluminium based saucepans can leave shiny metal marks on the pan supports. Clean the pan supports regularly to remove the marks using a mild abrasive like 'Jif' with a soft scourer. For more stubborn marks you can use a soap-filled pad such as 'Brillo'.

After cleaning the cooker parts, dry them thoroughly before you put them back.



When replacing hotplate burner parts

1. Crown to body (Do not try to force the crown on to the body).

Make sure that the hole in the crown is over the electrode. Check that the two longer location pegs sit in the slots in the body. When the crown is in this position let it fall freely on to the body. Check that the crown can be moved slightly from side to side.

2. Cap to crown

Place cap centrally on the top of crown (enamel side up). Move sideways and front to back to check the cap is properly fitted.

3. Check for ignition

If a burner will not light then you need to check the crown and cap positions.

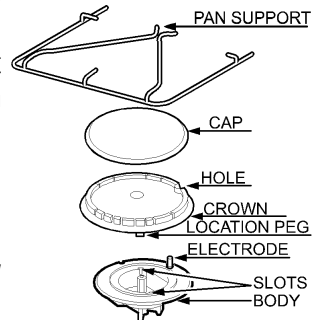

Grill and oven furniture

Clean the grill, and oven furniture frequently.

After use you can soak the grill pan, meat tin and trivet for a few minutes and then clean it using mild abrasives or a soap filled pad such as 'Brillo'.

Clean the grilling grid, handle and shelf using hot soapy water. Mild abrasives can be used if necessary.

The heat in the oven will change the colour of the solid plate on the top oven shelf. You must not remove the solid plate from the shelf. Soaking in hot soapy water will make cleaning easier.









The grill pan, grid, trivet and meat tin may be washed in a dishwasher.

The main fan oven

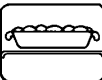
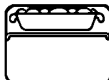
The top, sides and back of your oven are coated in a special material which helps to keep itself clean.

Follow these simple rules to maintain the appearance of the special finish.



- 1  Do not overfill dishes or they will boil over. 
- 2  Do not put dishes too high in the oven. If you do they may stick to the oven roof. 
- 3  Cover your roasting tins with foil. This will prevent fat splashing. 
- 4  Use a roasting tin which is just large enough for the meat and potatoes. This will help to reduce fat splashing. 
- 5  Dry any vegetables that you are going to roast. If they are wet there will be more fat splashing. 
- 6 Follow the oven cleaning cycle regularly.

Main oven cleaning cycle

You need to follow the cycle to keep the inside of the oven in good condition. The type of cooking you do will affect how often you need to follow the cycle.

If you do a lot of roasting and very little other baking you should follow the cleaning cycle once a week. If you do very little roasting you will only need to follow the cleaning cycle every 2-3 weeks.

To carry out a cleaning cycle:

1. Remove the oven shelves.

2. Turn the temperature to 220°C for 1 - 2 hours or until the oven is presentably clean. Some staining will remain.

MAIN OVEN

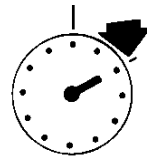
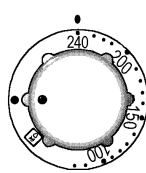

2 hrs.

Do not use any cleaning agents or scrapers on the inside of the oven. Do not wash the special finish.



Top oven cleaning cycle

1. Remove the oven shelf.

2. Set the oven to mark 5 for at least 30 minutes.

TOP OVEN/GRILL

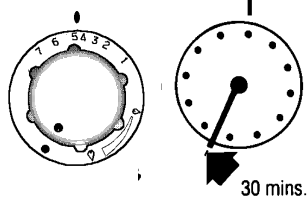

3. Turn the temperature up to mark 7 for 2 hours or until the oven is presentably clean.
Some staining will remain.

TOP OVEN/GRILL

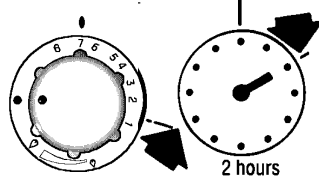

Do not use any cleaning agents or scrapers on the inside of the oven. Do not wash the special finish.



General

Clean the base of the oven, the oven shelf and the oven door while they are still slightly warm. This way you can easily remove any splashes and spills. Wipe the base with a cloth that has been wrung out in hot soapy water. You may use mild abrasives.

Cleaning between the outer and inner door glass.

You can remove the glass from the oven door if you need to.

To remove the outer glass

- 1 Open the door so you can get at the two cross head screws on the top of the door.
- 2 Loosen these two screws using a pozidrive screwdriver.
- 3 You should hold the door glass securely in place with one hand, whilst removing the screws completely, with the other hand. If you do not do this, the door glass could fall forward.
- 4 Using both hands, gently tilt the top of the door glass towards you. Lift it slightly to disengage the locators at the bottom of the door.

Please note that the door glass on your product may differ in type and shape from that shown in the diagram.

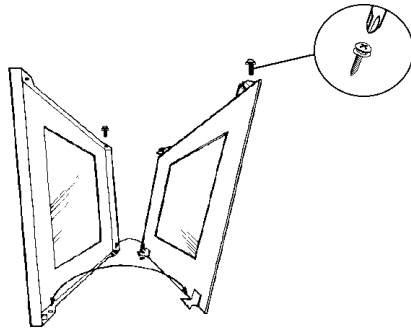

- 5 Clean the outer and inner glass using hot soapy water and mild abrasives such as 'Jif'. DO NOT try to clean the aluminium foil which is inside the door. The foil is there to keep the door cool, if it is damaged it will not work.
- 6 Replace the glass by holding it in both hands and gently placing the locators into the holes of the brackets at the bottom of the door, and make sure the screw location holes line up.
- 7 Hold the glass in place with one hand and replace the cross head screws into the location holes, with the other hand.
- 8 Tighten the screws using a pozidrive screwdriver. Close the door.

General

Clean the base of the oven, the oven shelves, and the oven door while they are still slightly warm. This way you can easily remove any splashes or spills. Wipe the oven base with a cloth that has been wrung out in hot soapy water. You may use mild abrasives.

Cleaning The Door Glass

 To prevent damaging or weakening the door glass panels avoid the use of the following:

- Household detergents and bleaches
- Impregnated pads unsuitable for non-stick saucepans
- Brillo/Ajax pads or steel wool pads
- Chemical oven pads or aerosols
- Rust removers
- Bath/Sink stain removers

 If the door glass panel becomes chipped or has deep scratches the glass will be weakened and must be replaced to prevent the possibility of the panel shattering. Please contact your local Service Centre who will be pleased to advise further.

Installing the cooker

For your safety

This cooker must be installed and serviced by a competent person as stated in the Gas Safety (Installation & Use) regulations current editions and the IEE Wiring Regulations.

It is important that the cooker is suitable for your gas supply. Your installer should check the data badge.

Make sure that a stability bracket is fitted.

Location

For your safety

The use of a gas cooking appliance results in the production of heat and moisture in the room in which it is installed. Ensure that the kitchen is well ventilated: keep natural ventilation holes open or install a mechanical ventilation device (mechanical extractor hood).

Prolonged intensive use of the appliance may call for additional ventilation, for example opening of a window, or more effective ventilation, for example increasing the level of mechanical ventilation where present.

For further details see page 46.

Positioning

The diagram shows how close to the cooker cupboards, shelves, curtains and so on can be fitted. Look at the diagram and carefully read the instructions to make sure your cooker is fitted safely. If you are in doubt your installer will give you advice.

- This is a type X cooker which means it is free-standing and can be fitted with cabinets on one or both sides.
- Do not fit any materials which may catch fire, for example wood or curtains behind the cooker.
- Base units which are higher than the hotplate must be 100mm away.

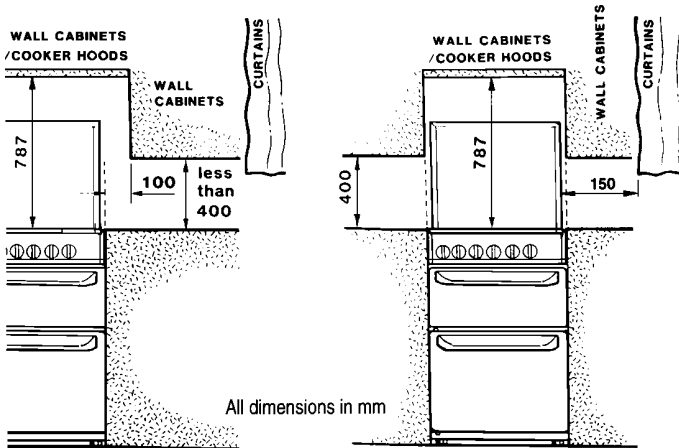

- If a cooker hood is fitted check the cooker hood installation instructions.
- We recommend that cabinets fitted next to or above the cooker meet British Standards. Your installer will give you advice if you are not sure.

Cooker dimensions

Height to hotplate:	898mm - 920mm (adjusted by two screw feet)
Width:	598mm
Depth:	600mm (to front of door panel)

General information

For your safety

Do not block any of the cooker vents.

Never line any part of the cooker with aluminium foil.

Don't let items which can catch fire or electric mains leads such as kettle flexes trail over any part of the cooker.

Moving your cooker

You may damage some soft or badly fitted floor coverings when you move the cooker. The floor covering under the cooker should be securely fixed so it does not ruck up when you move the cooker across it. Alternatively you could remove the floor covering.

To move the cooker open the grill door. Raise the cooker off its front feet by lifting it from inside the grill. Pull the cooker forward. When you replace the cooker push it back to the stop and make sure there is the same gap at each rear corner.

For your safety

Do not try to disconnect the cooker from the gas supply if the supply pipe does not have a bayonet connection, as described in the installation instructions. If this is the case contact the person who installed the cooker.

Connecting to the electricity supply

For your safety

This cooker must be earthed and protected by a 13 amp fuse.

The plug supplied with the cooker can be fitted directly to a suitable three pin earthed socket.

If you have to change the fuse replace it with a 13 amp fuse which has been ASTA approved to BS 1362.

Do not use the plug until you have put the fuse cover back on. If the fuse cover is lost you can get a replacement from an electrical retailer. The correct replacement can be identified by marking or colour coding.

If you cut the plug off dispose of it safely as it will be a shock hazard if it is inserted into a 13 amp socket elsewhere in the house.

If the ignition system doesn't work there may be a fault with the electrical supply. First, check the socket by trying out another piece of electrical equipment in it, if that works correctly renew the fuse in the plug.

If the fuse keeps failing there is a fault in the cooker which must be put right. Do not use a fuse with a rating higher than 13 amps. Do not carry out other electrical work. Unplug the cooker and tell your installer.

Replacing the oven light bulb

You need a 25 Watt small Edison screw with a temperature rating of T300.

- Make sure the oven is cool before you replace a bulb.
- Unplug the cooker.
- Open the oven door and remove the oven shelves.
- Place palm of hand at top of lens flat against oven side. Use fingers to lever lens away from housing.
- Unscrew the bulb by turning it to the left.
- Fit a new bulb and then replace the glass bulb cover.
- Replace the oven shelves.
- Plug the cooker back into the electricity supply.

The oven light bulb is not covered by the manufacturers guarantee.

What is wrong and why?

We strongly recommend that you carry out the following checks on your cooker before calling a Service Engineer.

Problem

The grill or hotplate will not light.

Check

- If only the hotplate burners will not light make sure that the burner parts have been replaced correctly. See instructions on page 31.
- If you cannot hear any sparking when you press the ignition button there may be a fault with the electrical supply. First check the socket by trying out another piece of electrical equipment in it. If that works, renew the fuse in the plug. Use a 13 amp fuse. If the fuse 'blows' again there is a fault on the cooker. Do not use a fuse with a rating higher than 13 amps. Do not carry out other electrical work. Unplug the cooker and tell your installer. If the cooker will not light because there is an electrical power failure such as a power cut you cannot use the oven. The grill and hotplate burners may be lit with a match.
- Check that there is not a problem with your gas supply. You can do this by making sure that other gas appliances such as your central heating or gas fire are working.

Problem

Food is cooking too quickly or too slowly.

Check

- Check that you are using the recommended temperature settings. See pages 17 - 23. Be prepared to adjust the temperature up or down by 10°C to get the results you want.

Problem

The oven is not cooking evenly.

Check

- Check that the cooker is installed properly and is level.
- Check that you are using the recommended temperatures. See pages 17 - 23.
- Check that the oven shelves are evenly spaced when more than one is used.
- Ensure food in the top oven is turned round during cooking.

Problem**The oven fan is noisy****Check**

- Check that the cooker is properly installed and is level.
- Check that shelves and bakeware are not vibrating in contact with the back panel in the oven.

Problem**The oven does not work****Check**

- Check that the clock is set for manual cooking. See page 26.
- Check that the cooker has been plugged in and switched on at the wall.
- Check that you have correctly followed the instructions for using the oven. See pages 5 and 6.
- Check that there is not a fault with the electrical supply. If the cooker will not work because there is an electrical power failure such as a power cut, you can not use the main oven.

Problem**Having difficulty cleaning any part of the cooker.****Check**

- Check that the instructions for care and cleaning, beginning on page 30 are being followed.

Problem**The oven light will not work.****Check**

- If the light does not work you probably need to replace the bulb. To do this see instructions on page 39.
- Check there is not a fault with the electrical supply.
- First, check the socket by trying out another electrical appliance in it, if that works renew the fuse in the plug. Use a 13 amp fuse. If the fuse 'blows' again this indicates that there is a fault on the cooker. Do not use a fuse with a higher rating than 13 amps. Do not carry out further electrical work. Unplug the cooker and inform your installer.

IMPORTANT: If you call out an engineer to rectify a fault listed here, or to repair a fault caused by incorrect use or installation a charge will be made, even if the appliance is in guarantee.

Service and spare parts

In the event of your appliance requiring service or if you wish to purchase spare parts please contact your local Zanussi Service Force Centre by telephoning

08705 929929

Your call will be routed to the Service Force Centre covering your postcode area.

Zanussi customers in Ireland should telephone (01) 4090751

Before you call an engineer check through the information under the heading 'What is wrong and why?'

In-guarantee customers should ensure that the checks under the heading 'What is wrong and why?' have been made as the engineer will make a charge if the fault is not a mechanical or electrical breakdown.

Please note that it is necessary to provide proof of purchase for any in-guarantee service calls.

When you report a problem try to describe the nature of the fault. Always give your cooker's full name, model and serial number. Make a note of this information in this space:

Name:

Model Number:

Serial Number:

G.C. Number:

For your safety

Maintenance must only be carried out by a competent /qualified person. Do not try to repair or alter/modify the cooker yourself as this could be dangerous.

We recommend that your cooker has an annual gas safety check carried out by our approved service organisation.

Customer Care Department

For general enquiries concerning your Zanussi cooker or further information on products, you are invited to contact our Customer Care Department by letter or telephone to the address below or visit our website <http://www.Zanussi.co.uk>

Customer Care Department
Zanussi
55-77 High Street
Slough
Berkshire
SL1 1DZ

Tel: 08705 727727 *

* calls to this number may be recorded for training purposes.

The Gas Consumers' Council

The Gas Consumers' Council (GCC) is an independent organisation which protects the interests of gas users.

If you need advise, you will find the telephone number in your local telephone directory under Gas.

Guarantee Conditions

Standard guarantee conditions

We, Zanussi, undertake that if within 12 months of the date of the purchase this Zanussi appliance or any part thereof is proved to be defective by reason only of faulty workmanship or materials, we will, at our option repair or replace the same FREE OF CHARGE for labour, materials or carriage on condition that:

- The appliance has been correctly installed and used only on the electricity supply stated on the rating plate
- The appliance has been used for normal domestic purposes only, and in accordance with the manufacturer's instructions
- The appliance has not been serviced, maintained repaired, taken apart or tampered with by any person not authorised by us
- All service work under this guarantee must be undertaken by a Zanussi Service Force Centre.
- Any appliance or defective part replaced shall become the Company's property
- This guarantee is in addition to your statutory and other legal rights

Home visits are made between **8.30am** and **5.30pm** Monday to Friday. Visits may be available outside these hours in which case a **premium** will be charged.

Exclusions

This guarantee does not cover:

- Damage or calls resulting from transportation, improper use or neglect, the replacement of any light bulbs or removable parts of glass or plastic
- Costs incurred for calls to put right an appliance which is improperly installed or calls to appliances outside the United Kingdom
- Appliances found to be in use within a commercial environment, plus those which are subject to rental agreements
- Products of Zanussi manufacture which are not marketed by Zanussi

European Guarantee

If you should move to another country within Europe then your guarantee moves with you to your new home subject to the following qualifications:

- The guarantee starts from the date you first purchased your product
- The guarantee is for the same period and to the same extent for labour and parts as exists in the new country of use for this brand or range of products
- This guarantee relates to you and cannot be transferred to another user
- Your new home is within the European Community (EC) or European Free Trade Area
- The product is installed and used in accordance with our instructions and is only used domestically, i.e. a normal household
- The product is installed taking into account regulations in your new country

Before you move please contact your nearest Customer Care centre, listed below, to give them details of your new home. They will then ensure that the local Service Organisation is aware of your move and able to look after you and your appliances.

France	Senlis	+33 (0)3 44 62 29 99
Germany	Nürnberg	+49 (0)911 323 2600
Italy	Pordenone	+39 (0)1678 47053
Sweden	Stockholm	+46 (0)8 738 79 50
UK	Slough	+44 (0)1753 219 897

TECHNICAL DATA

DIMENSIONS

	<i>Height</i>	<i>Width</i>	<i>Depth</i>
Height to hotplate	900mm (nominal)	600mm (nominal)	600mm (to front of door panel)
Space for fixing at hotplate level	2mm minimum clearance		
Space for fixing above hotplate level	Flush-see important note 'Location of Appliance' page 46.		
Minimum space above hotplate	787mm (If a cooker hood is fitted refer to the cooker hood installation instructions).		
Weight of appliance	64.5kg.		
Minimum distance from rear wall	5mm (spacer given by pressed spacer on vent panel).		

CONNECTIONS

Gas	Rear left hand side of cooker at hotplate level. Rc½ (½" B.S.P. female).
Electric	230V 50 Hz mains 3 core cable is supplied with an integral, moulded plug fitted with a 13 amp fuse.

IGNITION

Spark generator	APCO 6MG 6892
-----------------	---------------

GRILL

Heat Input	<i>Natural Gas</i> 3.3kW (11263 Btu/h)
Injector Marking	138
Injector Size	1.38mm
Cone Height	Not applicable as flame burns on surface of gauze

HOTPLATE

	<i>Natural Gas</i>			
	R.H.F.	R.H.R.	L.H.R.	L.H.F.
Heat Input	1.0kW (3412 Btu/h)	2.0kW (6824 Btu/h)	2.0kW (6824 Btu/h)	2.8kW (9554)
Btu/h)				
Injector Marking	079	104	104	130
Injector Size	0.79mm	1.04mm	1.04mm	1.30mm
Cone Length	10mm	15mm	15mm	10mm

MAIN OVEN

	<i>Electric</i>
Heat Input	2.5 kW

SECOND OVEN

	<i>Natural Gas</i>
Heat Input	2.4kW (8189 Btu/h)
Injector Marking	108
Flame Supervision Device	Diamond 'H' GSD 100/31
Dual Control	Sourdillon 60112/982

GENERAL

Ignition	H. T. Spark
Spark Gap	3-4mm

IMPORTANT - SAFETY REQUIREMENTS

This appliance must be installed in accordance with the Gas Safety (Installation and Use) Regulations Current Editions and the I.E.E. Wiring Regulations. Detailed recommendations are contained in the following British Standard Codes of Practice - BS.6172, BS.5440: Part 2 and B.S.6891. All British Standards must be 'Current Editions'.

PROVISION FOR VENTILATION

This appliance is not connected to a combustion products evacuation device. It shall be installed and connected in accordance with current installation regulations. Particular attention shall be given to the relevant requirements regarding ventilation.

The room containing the appliance should have an air supply in accordance with BS.5440: Part 2 Current Edition. All rooms require an openable window or equivalent and some rooms will require a permanent vent as well. For room volumes up to 5m³ an air vent of 100 cm² is required; for room volumes between 5m³ and 10m³ an air vent of 50cm² is required. If the room has a door that opens directly to the outside, no air vent is required. For room volumes that exceed 11m³ no air vent is required. If there are other fuel burning appliances in the same room, BS.5440: Part 2 Current Edition should be consulted to determine the requisite air vent requirements.

If your cooker is in use over a long period of time you may need additional ventilation in your kitchen. This can be achieved by opening a window or, if an external fan or cooker hood is fitted, switching this on or to a higher setting.

LOCATION OF APPLIANCE

This is a type X appliance which means it is free-standing and can be fitted with cabinets on one or both sides. This appliance must not be installed in a bed-sitting room of volume less than 20m³ or in a bathroom or shower room. It is essential that the appliance is positioned as stated below (see Fig. 1a)) i.e. shelves, wall cabinets and cooker hoods must be fitted a minimum of 787mm directly above the top of hotplate and 400mm above the hotplate when fitted in line with the outside of the appliance. If the units are intended to be fitted adjacent to the appliance but less than 400mm above the hotplate, then a minimum space of 100mm must be maintained between the sides of the unit and the appliance (see Fig.1b). Curtains must not be fitted immediately behind the appliance or within 150mm of the sides of the hotplate. If fitted next to or between two base units a minimum space of 1mm must be left between each unit and the sides of the appliance. The levelling feet fitted to the appliance will achieve a nominal height to hotplate trims of 900mm +20mm.

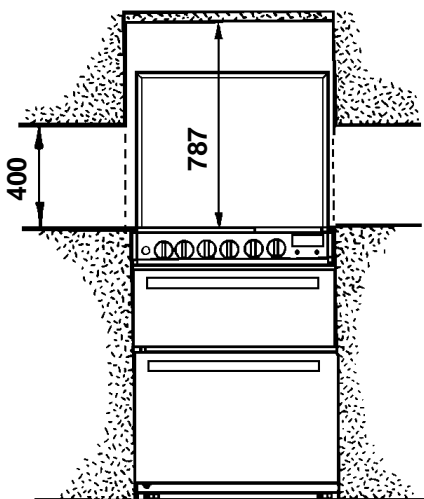

Fig. 1a

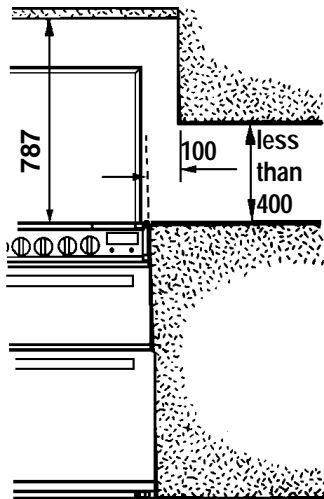

Fig. 1b

All dimensions in mm

LOCATION OF STORAGE BOARD

Storage board kits are available from your retailer.

Fix the Storage Board by drilling 2 holes of 6 mm in diameter in the position shown. See fig 1c.

Use screws and wall plugs provided in the pack.

To enable the Storage Board to be fitted, a 2 mm gap between the screw head and wall is required. See fig 1d.

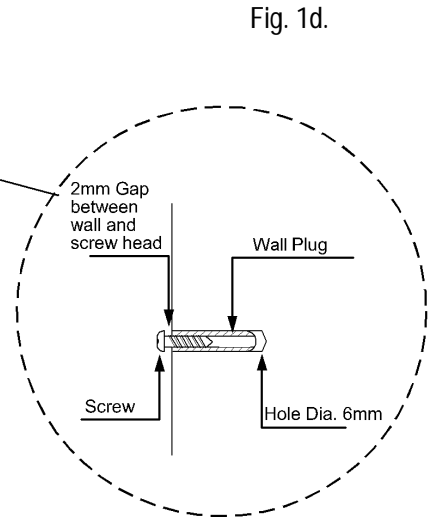
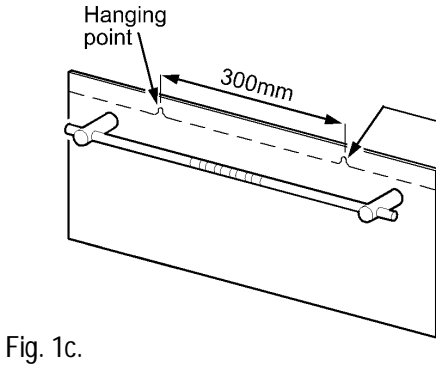

Please note that the handle and storage board may differ in type and shape from that shown in the diagram.

INSTALLATION

1. PARTS REQUIRED

The loose hotplate parts are packed in the polystyrene fitment on top of the hotplate.

2. LEVELLING THE APPLIANCE

If the appliance requires levelling or its height adjusting (from the hotplate to any working surface), the procedure below must be followed:

1. Adjustment to suit floor conditions or height is obtained by rotating clockwise or anticlockwise the feet, at the front and rear of the appliance.
2. A spirit level should be placed on one of the oven shelves to confirm the appliance is correctly levelled.

3. FITTING THE STABILITY BRACKET

It is recommended that if the appliance is to be installed with a flexible supply pipe a stability bracket (SK.4729.A) is fitted and is available from your supplier (see Important Safety Requirements, Page 46). These instructions should be read in conjunction with the leaflet packed with the stability bracket.

1. Place the appliance in its intended position and level appliance.
2. Mark off 300mm from the left hand side of the appliance as shown in dimension 'A', Fig 2a. This is the centre line of the fixing bracket.
3. Draw a line 100mm from the front edge of the levelling feet (see Fig.2a) and remove appliance from its position. Mark off dimension 'B' (see Fig.2a) back from this line on the centre line of the bracket to locate the front edge of the lower bracket. Fix lower bracket (with two fixing holes) to the floor then measure the height from floor level to engagement edge on back of appliance, dimension 'C' of Fig.2b.
4. Assemble upper bracket to lower bracket so that underside of bracket is dimension 'C' +3mm above floor level.

Reposition appliance and check that top bracket engages into appliance back as shown in Fig. 2b.

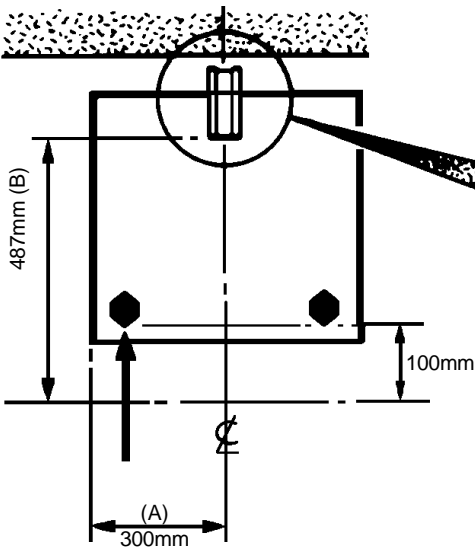

Fig. 2a

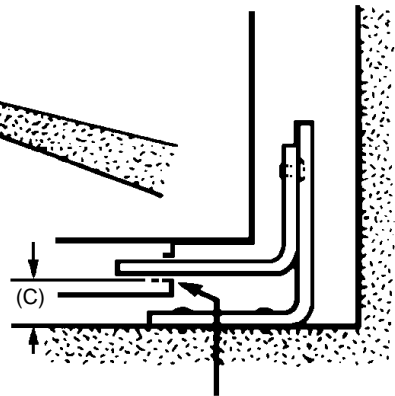
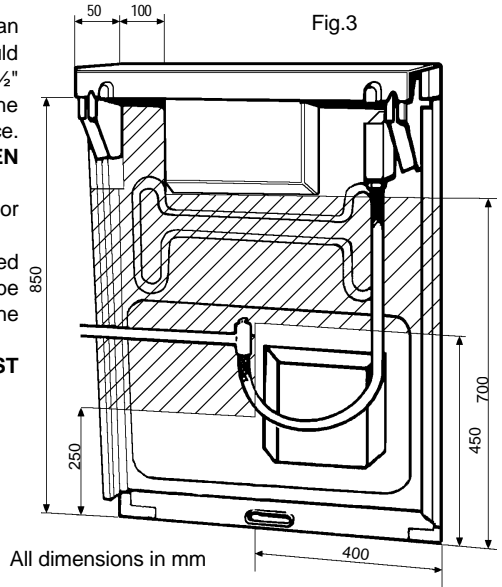

Fig. 2b

4. CONNECTING TO GAS

This appliance is designed to be installed with an appliance flexible connection only. Supply piping should not be less than R³/8. Connection is made to the Rc ½ (½" B.S.P.) female threaded entry pipe located just below the hotplate level on the rear left hand side of the appliance. **NOTE: ONLY LIQUID SEALANTS TO BE USED WHEN INLET GAS PIPE IS FITTED TO SHUT OFF VALVE I.E.: DO NOT USE P.T.F.E. SEALANT TAPE.** Check for gas soundness after connecting to the gas supply.

The gas bayonet connector must be fitted in the shaded area indicated in Fig.3. Take into account that it must be possible to pull the appliance forward sufficiently. The hose must not get caught on the stability bracket. **IMPORTANT: FLEXIBLE TUBING USED MUST COMPLY WITH BS. 669 CURRENT EDITION.**



5. CONNECTION TO THE ELECTRICITY SUPPLY

WARNING: THIS APPLIANCE MUST BE EARTHED. DO NOT EARTH THIS APPLIANCE TO THE GAS SUPPLY PIPING.

This appliance must be connected to a 230V A.C. 50Hz supply. It is supplied with 2 metres of 15 amp 3 core cable incorporating a moulded 13 amp plug, fitted with a 13 amp fuse, which can be plugged directly into the nearest suitable socket. If this is not long enough, the supply cable can be either:-

- (i) Replaced totally by a longer cable at least 1.5mm² nominal cross sectional area (30/0.25mm).
- (ii) Extended by using a B.E.A.B. approved 3-way sealed flex connector with integral flex clamps.

IF THE MOULDED PLUG IS CUT FROM THE CABLE FOR ANY REASON, IT MUST BE DESTROYED OR DISPOSED OF SAFELY, AS THE PROTRUDING WIRES WILL BE AN ELECTRIC SHOCK HAZARD.

If any other type of plug is used it should incorporate a 13 amp fuse in either the plug or adapter or at the distribution board.

If the cable has to be threaded through small apertures in cabinets etc., it may be disconnected from the appliance, then re-connected to as shown in Fig.4.

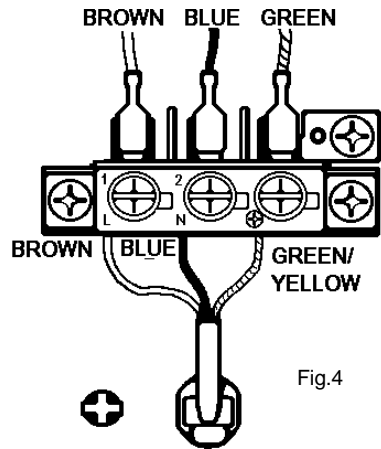

DO NOT EXTEND THE CABLE USING PLASTIC OR CERAMIC CONNECTION TERMINAL BLOCKS AND/OR INSULATION TAPE.

ALL EXTERNAL WIRING BETWEEN THE APPLIANCE AND THE ELECTRICAL SUPPLY SHALL COMPLY WITH I.E.E. WIRING REGULATIONS.

If the wiring is extended or a completely new cable fitted a 3-pin 13 amp plug should be fitted. (See Fig.4a). Connect the wires as follows:

BROWN to the Live Terminal.

BLUE to the Neutral Terminal.

GREEN and YELLOW to the Earth Terminal.

As the colours of the wires in the mains lead which you fit may not correspond with the coloured markings identifying the terminals in your plug, proceed as follows:

The wire which is GREEN and YELLOW must be connected to the terminal in the plug which is marked with the letter 'E' or by the earth symbol \perp or coloured GREEN or GREEN and YELLOW.

The wire which is coloured BLUE must be connected to the terminal which is marked with the letter 'N' or coloured BLACK.

The wire which is coloured BROWN must be connected to the terminal which is marked with the letter 'L' or coloured RED.

FIT A 13 AMP FUSE TO THE PLUG HOLDER.

Ensure that the supply cable cannot get caught by the stability bracket. **Plug in the appliance.**

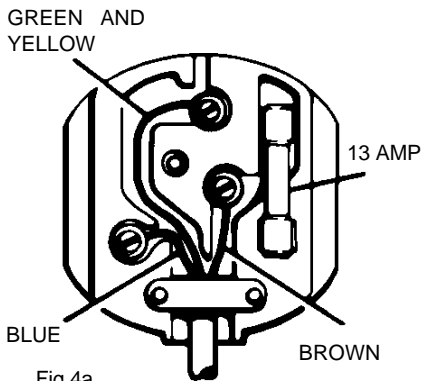

6. PRESSURE TESTING

- 1 The hotplate rapid burner injector is used as a pressure test point.
- 2 Lift the lid and connect the pressure gauge to the rapid burner injector.
- 3 Check the supply pressure by turning rapid burner tap on full and one other hotplate tap full on and light the appropriate burner. The pressure should be 20mbar for natural gas.
4. Turn off the taps and disconnect the pressure gauge.

7. CHECKING THE GRILL

Place the grill pan containing the grid and with handle attached into the grill compartment. To light the grill burner, turn the grill tap to its full on position, then press the ignition button until the burner is lit.

8. CHECKING THE HOTPLATE

Lift the lid. Fit the burner crowns and caps ensuring that they are correctly seated. Fit the pan supports. Check each of the hotplate burners in turn by turning the hotplate tap to it's full on position then pressing the ignition button until the burners are lit.

9. CHECKING LID SHUT-OFF DEVICE

1. Lift the lid.
2. Turn one hotplate burner tap to its full on position, then push and release the ignition button.
3. Close lid. There should now be no gas supply to the hotplate and the burner will go out.
4. Turn off the hotplate tap and lift the lid. The gas supply should now be restored to the hotplate, when the tap is turned on.

10. CHECKING THE MAIN OVEN CONTROLS

TO SET THE TIME OF DAY (see Fig.5)

1. Turn on the electricity supply and ensure that the thermostat is in the off position.
 - 1a. Before setting timer read important note below.
2. Rotate the left hand clock knob to manual and back to the clock Time Setting position.
3. Set the time of day by rotating the right hand knob. Note that it is a 24 hour clock.
4. Rotate the left hand clock knob back to the manual position.

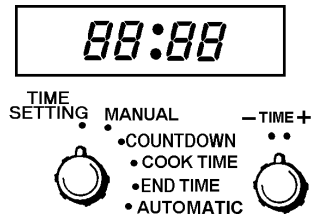

Fig.5

NOTE: When setting the time of day with the selector knob in the Time Setting position only, this will activate the timer for seven seconds after selection. This means that when setting the time of day in this function the time can only be set by using the right hand knob within a seven second period.

After seven seconds have elapsed from when the correct time of day has been set, the timer ceases to be active and subsequent operation of the right hand knob will not change the time setting.

When the right hand knob is turned anti-clockwise after the seven second delay period, a choice of three audible signals are available. To select the choice of signal required rotate knob anti-clockwise and release. Repeat procedure to choose desired signal.

11. CHECKING THE MAIN OVEN

1. Set the clock as described above, the oven is now ready for manual operation.
2. Turn the main oven thermostat to maximum. The oven fan and lamp will operate and after a short period the heat from the oven element may be felt when the oven door is opened.
3. Turn off the thermostat and check that the oven fan stops and the oven lamp goes out.

12. AUTOMATIC OPERATION

Having set the clock up as described above, turn the left hand knob to the 'Cook Time' position and set the right hand knob to show a cooking time of two minutes (0.02).

Turn the left hand knob to the 'End Time' position; the time shown on the display is now the time of day with two minutes added on. Rotate the right hand knob to add two minutes to this time to give a two minute delay.

Turn the left hand knob to the 'automatic' position to complete the programming sequence, the clock now shows the time of day again with 'auto' glowing continuously.

Turn the oven thermostat on and two minutes after setting, the oven fan and lamp should operate.

Two minutes after the oven starting, the timer should cut off power to the oven and the audible signal should sound. The signal is continuous and it may be switched off at any time by rotating the left hand knob.

Return timer to manual by rotating the left hand knob to the 'manual' position.

13. CHECKING THE MAIN OVEN LIGHT

Turn the main oven thermostat knob full on and check that the main oven light is working. Turn off the thermostat.

GENERAL NOTE

Instruct the user on how to use the appliance and its ignition system.

Refer the user to the wording in the inside cover which gives advice on the safe operation of the appliance.

NOTES

NOTES

NOTES

ZCM I D 311513600

Download from Www.Somanuals.com. All Manuals Search And Download.

© Electrolux Household Appliances Limited 2000

PART NO: 311513600



Free Manuals Download Website

<http://myh66.com>

<http://usermanuals.us>

<http://www.somanuals.com>

<http://www.4manuals.cc>

<http://www.manual-lib.com>

<http://www.404manual.com>

<http://www.luxmanual.com>

<http://aubethermostatmanual.com>

Golf course search by state

<http://golfingnear.com>

Email search by domain

<http://emailbydomain.com>

Auto manuals search

<http://auto.somanuals.com>

TV manuals search

<http://tv.somanuals.com>