

# ZANUSSI

## Electric Ceramic Hob ZKF641H

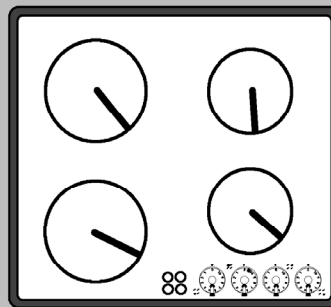

## Operating and Installation Instructions

# Contents

## User Instructions



<b>Important hints on safety</b>	<b>3</b>
<b>Description of the appliance</b>	<b>4</b>
<b>Before first use</b>	<b>4</b>
<b>Operating Instructions</b>	<b>5</b>
Ceramic glass surface	5
Heat Controls & Settings	5
Residual heat indicator	6
Pots and pans	6
Energy Saving tips	6
<b>Maintenance and Cleaning</b>	<b>7</b>
<b>Something Not Working</b>	<b>8</b>
<b>Customer Care</b>	<b>8</b>
<b>Service and Spare Parts</b>	<b>8</b>
<b>Guarantee Conditions</b>	<b>9</b>
<b>Service Force Centres</b>	<b>10</b>

## Installation Instructions

Technical Details	12
Unpacking and Disposal	12
Installing in the kitchen worktop	12
Building-In	13
Electrical Connection	14

## RATING PLATE

The rating plate is located on the bottom of the appliance. Once the appliance has been built-in the rating plate is no longer visible. Please write the 'F Nr.' into the box below.

MADE IN GERMANY		
<b>TYP:</b> PEE2 014	<b>PNC:</b> 949 590 636	<b>MODEL:</b> ZKF 641H
AC 230 V	F.Nr.: .....	  
Total max. 6,0 kW		

 This appliance is corresponding to the EG-rules 73/23/EWG, 89/336/EWG and 90/683/EWG.



## Important hints on safety

**This safety information is provided in the interests of your safety. Please read it carefully before installing or using the hob. If you are unsure if the meaning of any of the warnings please contact our Customer Care Department.**

### Installation

- This appliance must be installed by a qualified electrician / competent person, according to the manufacturer's instructions and to the relevant British Standards.
- Remove all packaging before using the appliance.
- Ensure the electrical supply complies with the type stated on the rating plate.
- Do not attempt to modify the hob in any way.
- Do not install the hob if the ceramic glass is damaged or cracked.

### Child Safety

- This appliance is designed to be operated by adults. Do not allow children to play near or with the appliance.
- The appliance gets hot when it is in use. Children should be kept away until it has cooled.
- Children can also injure themselves by pulling pots or pans off the hob.

### During Use

- Only use the hob when it is fully installed.
- This hob is intended for domestic cooking only. It is not designed for commercial or industrial purposes.
- Ensure the power ON/OFF switch is off when the hob is not in use.
- When using other electrical appliances, ensure the cable does not come into contact with the hot surfaces of the hob.
- Do not use unstable or misshapen pans on the hob.
- Never leave the hob unattended when cooking with fat or oil.
- Never use plastic or aluminium foil dishes on the hob.

- The cooking zones heat up quickly when they are turned on. Only turn them on when a saucepan is on the cooking zone.
- The residual heat indicator will not operate if there is a power failure.
- Do not store temperature sensitive or inflammable materials (e.g. detergents or aerosols) in drawers or cupboards underneath the hob.
- The hob surface must not be used for storage or as a working area.
- Do not allow sugar (solid or liquid) or plastic to come into contact with the hob surface when hot.
- Clean the hob in accordance with the Maintenance and Cleaning instructions.
- Do not use the hob if the glass is damaged or becomes cracked, contact your local Service Force Centre.

### Service

- This hob should only be repaired or serviced by an authorised Service Engineer and always insist on genuine spare parts.

### Disposal

- Please dispose of any packaging material and old appliances at authorised disposal sites with due regard for the environment.



Safety Hints and information



Environmental information

# Description of the Appliance

- |                               |          |        |
|-------------------------------|----------|--------|
| 1. Cooking Zone               | ∅ 180 mm | 1800 W |
| 2. Cooking Zone               | ∅ 180 mm | 1800 W |
| 3. Cooking Zone               | ∅ 145 mm | 1200 W |
| 4. Cooking Zone               | ∅ 145 mm | 1200 W |
| 5. Residual Heat Indicator    |          |        |
| 6. Heat setting control knobs |          |        |

**Voltage AC 230 V**  
**Total connected Load 6.0 kW**

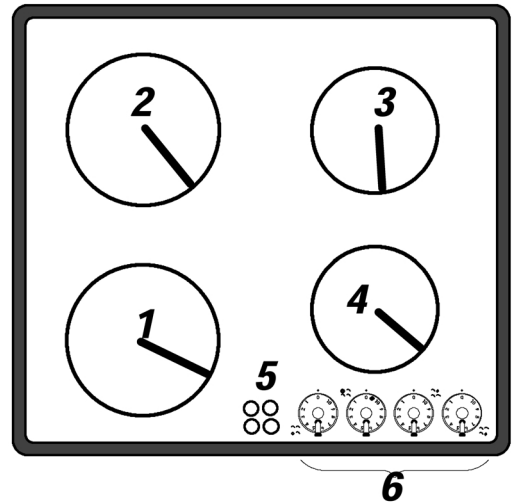

## Before first use



Please check that the appliance was delivered in perfect condition. Appliances with obvious transport damage must not be connected to the mains.

### First Cleaning

In order to remove any remnants left by production, clean the hob before its first use.

Ensure any labels and protective films on the hob are removed.

Clean the ceramic glass and the frame with hot water and a little washing up liquid added.

### First Heating Up

Check each cooking zone, in turn, by briefly switching to the maximum setting (10).

When using the ceramic hob for the first time it can temporarily emit an odour.

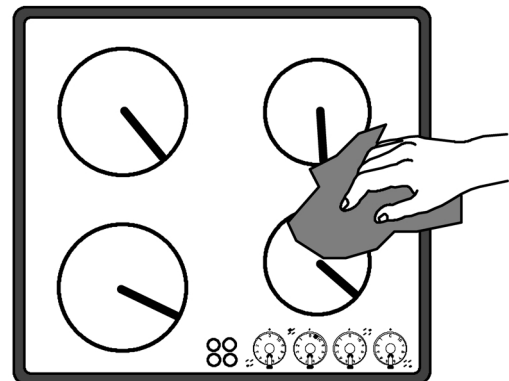

# Operating instructions

## Ceramic glass surface

The cooking surface is made of proven ceramic glass. The surface is non-porous and, in addition, insensitive to quick variations in temperature. Therefore pots may be moved from a hot to a cold zone.

When switching on the cooking zones you may hear a short-term audible buzzing sound of the radiant elements. This will not harm the performance of the appliance.

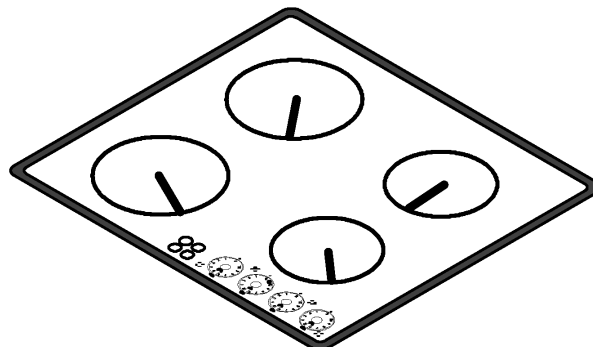

Keep all objects and materials that might smelt away from the heat zones. Sugar solutions, food stuffs with a high sugar content, plastics, or kitchen foil – must be removed immediately with a glass scraper. If this type of soiling is not removed immediately it can cause irreparable damage to the ceramic glass surface. Which is not covered by the guarantee.

When the surface has cooled, wipe over with a damp cloth and Vitroclen.

## Heat Controls

The cooking zones regulate the heating capacity of the cooking zones.

The control knobs for the cooking zones can be turned to the left and to the right to desired position.

- 1 = minimum setting
- 10 = maximum setting
- 0 = OFF



After use make sure that the appliance is switched off by ensuring that all control knobs are set to '0'.

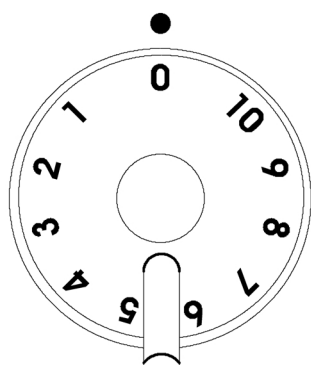

Heat Zone Setting Chart		
Function		Examples
OFF	0	
Keeping warm, gentle heating, beating or melting	1 2	Small amounts of hotpot, sauce, butter or chocolate
Swelling, defrosting	3	Rice, spinach
Frying without crust	4	Omelette, fried eggs
Simmering, swelling	5	Vegetables, fruit with little liquid, farinaceous product
Boiling	6	Potatoes, stews, soups, sauces
Frying Baking	7	Schnitzel, cutlets, meatballs, fish fillets in deep fat.
Quick frying	8	Potato fritters, pancakes, fried eggs
Parboiling, lightly frying	9 10	... the switch back to an appropriate setting

## Residual Heat indicator

Each cooking zone is related to one indicator. The warning lamp illuminates when the surface of the corresponding cooking zone reaches a temperature which could cause burns.

The indicator remains illuminated after the area heated has been switched off as long as the residual heat of the corresponding cooking zone could cause burns.

The light will go out when the temperature falls below 60°C.

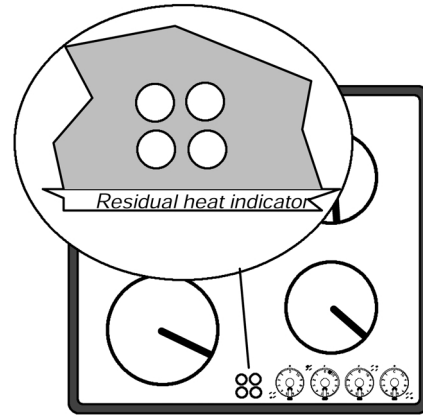

## Saucepans and frying pans.

Saucepans and frying pans should not be smaller than the cooking zone, and preferably not more than 10-15 mm larger than the cooking zone.

The bases should always be clean and dry. Cook with a lid in place.

Always use cooking and frying utensils with smooth, flat bottoms. Bases with burrs and sharp edges will scratch the ceramic glass surface.

Scratches can also be caused by grains of sand (e.g. originating from washed vegetables), drawn over the cooking surface with the pan, or by burrs and rims on the base of pans.

**To avoid scratching or damaging the ceramic glass surface, pots and pans should be moved on the hob by lifting them and not by sliding.**

Utensils with aluminium and copper bases can leave behind metallic discolouration which can only be removed with difficulty and sometimes not at all.

When cold, pan bases normally curve slightly inwards by approx. 0.1-0.5 mm (concave). In no case should they curve outwards (convex).

Follow any guidelines provided by the saucepan manufacturer. Ensure that they are recommended for use on ceramic hobs.

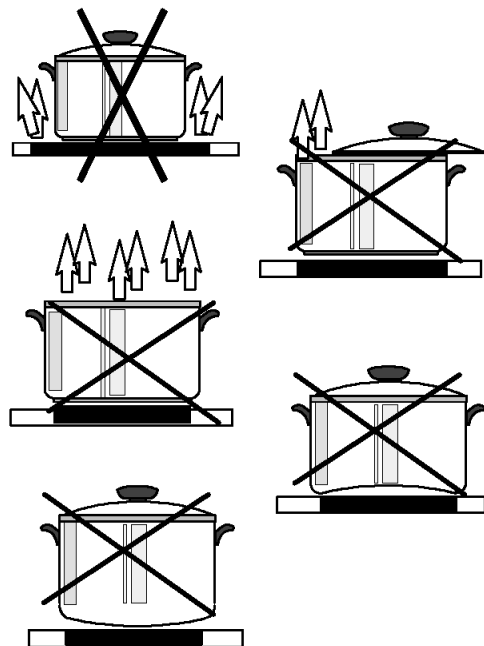
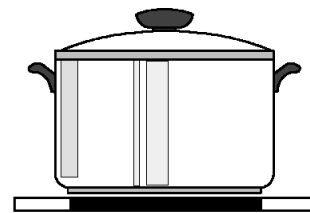

## Energy Consumption



To save energy, you should...

- Only use cooking and frying utensils with flat smooth bases.
- Place pots and pans in position before switching on the cooking zone.
- Wherever possible, cover pots and pans with a lid.
- Switch off the cooking zone a few minutes before the end of the cooking time, in order to make use of the residual heat.
- Use the residual heat of the cooking zone for keeping food warm, or for melting.
- Position pots and pans centrally on the cooking zone

# Maintenance and Cleaning

Before cleaning, make sure that the hob is cool and disconnected from the power supply.



Never use aggressive or abrasive agents, such as oven sprays, stain or rust removers, scouring powder, or sponges with an abrasive effect.

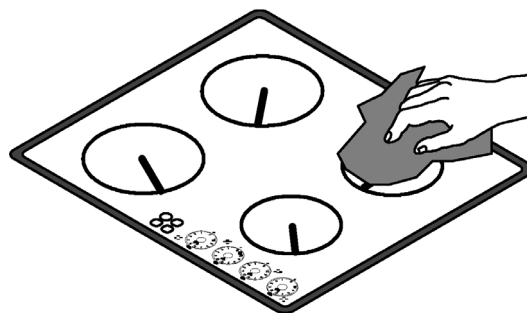

Special cleaning agents such as Vitroclen and ceramic glass scrapers are available from department stores and electrical specialists.

## Cleaning after each use

- Slight, non-burnt soiling can be wiped off with a damp cloth.
- Burnt soiling has to be removed with a scraper. Afterwards wipe off the ceramic glass surface with a damp cloth and Vitroclen.

## Stain removal

- Light metallic stains (aluminium residues) can be removed from the cooking zone with a ceramic hob cleaning agent such as Vitroclen.
- Sugar solutions, food stuffs with a high sugar content, plastics, or kitchen foil must be removed immediately with a scraper. If this type of soilage is not removed immediately it can cause irreparable damage to the ceramic glass surface. When the surface has cooled wipe over with a damp cloth and Vitroclen.
- Before using any detergent or cleaning agent on the ceramic glass surface, ensure they are recommended for use on ceramic hobs.
- Do not apply any cleaning agents to hot cooking zones. Ensure that any residues are wiped off before the cooking zones are used again.

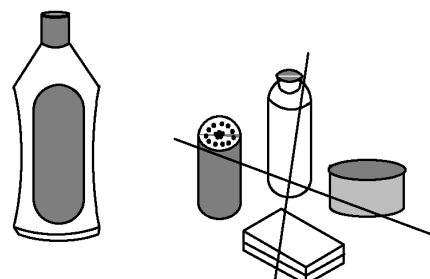

Special Problems	
... when a chemical cleansing agent is not sufficient.	Use a glass scraper to aid cleaning.
... when dark stains have appeared.	If cleaning with a glass scraper and Vitroclen does not help, the décor has been cleaned with an unsuitable cleaning agent or scoured by rough ban bases.
... when metallic discolouration appears on the cooking surface.	The cleansing agents that were used were for the most part unsuitable. The discolouration can only be removed with difficulty using Vitroclen.
... when the surface shows scratches or hollows.	These flaws are caused by scratching or melted objects and cannot be removed, however, this does not reduce the performance of the hob.

# Something Not Working

If your hob is not functioning correctly please carry out the following checks before calling out an engineer.

**Important:** If you call out an engineer to a fault listed below, or to repair a fault caused by incorrect use or installation, a charge will be made even if the appliance is under guarantee.

Symptom	Possible Solution
<ul style="list-style-type: none"><li>The cooking zones do not function.</li></ul>	<ul style="list-style-type: none"><li>Check the mains has not failed.</li><li>Check a power level has been selected.</li></ul>
<ul style="list-style-type: none"><li>After switching off a cooking zone the residual heat indicator is not illuminated.</li></ul>	<ul style="list-style-type: none"><li>The cooking zone may have only been switched on for a short while, and is therefore below 60°C.</li></ul>
<ul style="list-style-type: none"><li>A buzzing is heard when a cooking zone is first switched on.</li></ul>	<ul style="list-style-type: none"><li>This is not a fault, the buzzing will disappear as the zone heats up.</li></ul>
<ul style="list-style-type: none"><li>Discolouration appear in the cooking zone.</li></ul>	<ul style="list-style-type: none"><li>This is probably the result of burned of remnants that have not been removed regularly. They will not affect the function of the hob.</li></ul>

If after carrying out the above checks there is still a fault, contact your local Zanussi Service Force Centre.

# Service and Spare Parts

In the event of your appliance requiring service, or if you wish to purchase spare parts, please contact your local Zanussi Service Force Centre by telephoning:-

**08705 929929**

Your telephone call will be automatically routed to the Service Force Centre covering your post code area. The addresses are listed on the following pages.

Before calling out an engineer, please ensure you have read the details under the heading "Something Not Working."

When you contact the Service Force Centre you will need to give the following details:

1. Your name, address and post code
2. Your telephone number
3. Clear and concise details of the fault
4. The model and serial number of the appliance (found on the rating plate)
5. The purchase date

## Customer Care

For general enquiries concerning your Zanussi appliance or for further information on Zanussi products, please contact our Customer Care Department by letter or telephone at the address below or visit our website at [www.zanussi.co.uk](http://www.zanussi.co.uk)

Customer Care Department  
Zanussi  
55-77 High Street  
Slough  
Berkshire  
SL1 1DZ  
08705 727727 (\*)

\* calls to this number may be recorded for training purposes



# Guarantee Conditions

We Zanussi undertake that if within 24 months of the date of the purchase this Zanussi appliance or any part thereof is proved to be defective by reason only of faulty workmanship or materials, the company will, at our option repair or replace the same FREE OF CHARGE for labour, materials or carriage on condition that:

The appliance has been correctly installed and used only on the electrical supply stated on the rating plate.

The appliance has been used for normal domestic purposes only, and in accordance with the manufacturer's instructions.

The appliance has not been serviced, maintained, repaired, taken apart or tampered with by any person not authorised by us.

All service work under this guarantee must be undertaken by a Zanussi Service Force Centre.

Any appliance or defective part replaced shall become the Company's property.

Home visits are made between **8.30am** and **5.30pm Monday to Friday**. Visits may be available outside these hours in which case a premium will be charged.

## EXCLUSIONS

### **This Guarantee does not cover:**

Damage or calls resulting from transportation, improper use or neglect, the replacement of any light bulbs or removable parts of glass or plastic.

Costs incurred for calls to put right an appliance improperly installed or calls to appliances outside the United Kingdom.

Appliances found to be in use within a commercial environment, plus those which are the subject of rental agreements.

Products of Zanussi manufacture which are not marketed by Zanussi.

This guarantee is in addition to your statutory and legal rights.

## ZANUSSI EUROPEAN GUARANTEE

If you should move to another country within Europe then your guarantee moves with you to your new home subject to the following qualifications:

- The guarantee starts from the date you first purchased your product.
- The guarantee is for the same period and to the same extent for labour and parts as exists in the new country of use for this brand or range of products.
- This guarantee relates to you and cannot be transferred to another user.
- Your new home is within the European Community (EC) or European Free Trade Area
- The product is installed and used in accordance with our instructions and is only used domestically, i.e. a normal household.
- The product is installed taking into account regulations in your new country.

Before you move please contact your nearest Customer Care Centre, list below, to give them details of your new home. They will then ensure that the local Service Organisation is aware of your move and able to look after you and your appliances.

France	Senlis	+33 (0)3 44 62 29 29
Germany	Nuremberg	+49 (0)800 234 7378
Italy	Pordenone	+39 (0)0434 39 4700
Sweden	Stockholm	+46 (0)8 672 5390
UK	Slough	+44 (0)1753 219897

To contact your local Service Force Centre telephone **08705 929 929**

<p style="text-align: center;"><b>CHANNEL ISLANDS</b></p> <p>GUERNSEY      Guernsey Electricity PO Box 4 Vale, Guernsey Channel Islands GY1 3AD</p> <hr/> <p>JERSEY          Jersey Electricity Company Haut De L'orme Rue De Haut De L'orme Trinity Jersey Channel Islands JE3 5FG</p>	<p>ISLE OF LEWIS      ND Macleod 16 James Street Stornoway Isle of Lewis PA87 2QW</p> <hr/> <p>KELSO                2, 6 &amp; 8 Woodmarket Kelso Borders TD5 7AX</p> <hr/> <p>ORKNEY              7 King Street Kirkwall Orkney KW15 1JF</p> <hr/> <p>PERTH                Scottish Hydro Electric Central Warehouse Inveralmond Perth PH1 3AF</p> <p>(OWN SALES)</p> <hr/> <p>SHETLAND          3-4 Carlton Place Lerwick Shetland ZE1 0PW</p> <p>(OWN SALES)</p> <hr/> <p>SHETLAND          Bolts Shetland 26 North Road Lerwick Shetland ZE1 0PE</p> <p>(OWN SALES)</p> <hr/> <p>WHALSAY            Leask Electrical Harisdale Symbister, Whalsay Shetland ZE2 9AA</p> <p>(OWN SALES)</p>	<p style="text-align: center;"><b>NORTH EAST</b></p> <p>GATESHEAD        Unit 356a Dukesway Court Dukesway Gateshead NE11 0BH</p> <hr/> <p>GRIMSBY            15 Hainton Avenue Grimsby N. E. Lincs DN32 9AS</p> <hr/> <p>HULL                 Unit 1 Boulevard Industrial Estate Hull HU3 4AY</p> <hr/> <p>LEEDS                64-66 Cross Gates Road Cross Gates Leeds LS15 7YS</p> <hr/> <p>NEWTON AYCLIFFE   Unit 23 Northfield Way Aycliffe Industrial Park Newton Aycliffe DL5 6EJ</p> <hr/> <p>SHEFFIELD         Pennine House Roman Ridge Road Sheffield S9 1GB</p>
<p style="text-align: center;"><b>SCOTLAND</b></p> <p>ABERDEEN          54 Claremont Street Aberdeen AB10 6RA</p> <hr/> <p>AUCHTERMUCHTY   33a Burnside Auchtermuchty Fife KY14 7AJ</p> <hr/> <p>BLANTYRE           Unit 5 Block 2 Auchenraith Ind. Estate Rosendale Way Blantyre G72 0NJ</p> <hr/> <p>DUMFRIES           93 Irish Street Dumfries DG1 2 PQ</p> <hr/> <p>DUNOON             7 Hill Street Dunoon Argyll PA23 7AL</p> <hr/> <p>EDINBURGH        Unit 12 Dumbryden Ind. Estate 2 Dumbryden Road Edinburgh EH14 2AB</p> <hr/> <p>GLASGOW           Unit 4 Wellington Road Bishopriggs Glasgow G64 2SA</p> <hr/> <p>INVERNESS         Unit 3BI Smithton Ind. Estate Smithton Inverness IV2 7WL</p> <hr/> <p>ISLE OF ARRAN    R Haggerty Bruach Blackwaterfoot Isle of Arran</p> <hr/> <p>ISLE OF BARRA    J Zerfah 244 Bruernish Isle of Barra Western Islands HS9 5QY</p> <hr/> <p>ISLES OF BUTE    Walker Engineering Glenmhor Upper Serpentine Road Rothesay Isle of Bute PA20 9EH</p>	<p style="text-align: center;"><b>NORTHERN IRELAND</b></p> <p>BELFAST            Owenmore House Kilwee Business Park Dunmurry Belfast BT17 0HD</p>	<p style="text-align: center;"><b>NORTH WEST</b></p> <p>BIRKENHEAD       1 Kelvin Park Dock Road Birkenhead CH41 1LT</p> <hr/> <p>CARLISLE           Unit 7 James Street Workshops James Street Carlisle Cumbria CA2 5AH</p> <hr/> <p>ISLE OF MAN       South Quay Ind. Estate Douglas Isle of Man IM1 5AT</p> <hr/> <p>BOLTON             Unit B Central Industrial Estate St Marks Street Bolton BL3 6NR</p> <hr/> <p>PRESTON            Unit 250 Dawson Place Bamber Bridge Preston Lancashire PR5 8AL</p> <hr/> <p>STOCKPORT        Unit 20 Haigh Park Haigh Avenue Stockport SK4 1QR</p>
	<p style="text-align: center;"><b>WALES</b></p> <p>CARDIFF            Unit 4 Guardian Industrial Estate Clydesmuir Road Cardiff CF2 2QS</p> <hr/> <p>CLYWD              Unit 6-7 Coed Parc Abergele Road Rhuddlan Clwyd LL18 5UG</p> <hr/> <p>DYFED               Unit 9 St. Clears Business Park Tenby Road St. Clears Carmarthen SA33 4JW</p> <hr/> <p>OSWESTRY          Plas Ffynnon Warehouse Middleton Road Oswestry SY11 2PP</p>	

To contact your local Service Force Centre telephone **08705 929 929**

MIDLANDS	LONDON & EAST ANGLIA	SOUTH EAST
BIRMINGHAM 66 Birch Road East Wyrley Trading Estate Witton Birmingham B6 7DB	BECKENHAM 11a Gardner Ind. Estate Kent House Lane Beckenham Kent BR3 1QZ	ASHFORD Unit 2 Bridge Road Business Centre Bridge Road Ashford Kent TN23 1BB
BOURNE Pinfold Road Bourne PE10 9HT	CHELMSFORD Hanbury Road Widford Ind. Estate Chelmsford Essex CM12 3AE	FLEET Unit 1 Redfields Ind. Estate Church Crookham Fleet Hampshire GU13 0RD
BRIDGNORTH 68 St. Mary's Street Bridgnorth Shropshire WV16 4DR	COLINDALE Unit 14 Capitol Park Capitol Way Colindale London NW9 0EQ	HAYWARDS HEATH 21-25 Bridge Road Haywards Heath Sussex RH16 1UA
GLOUCESTER 101 Rycroft Street Gloucester GL1 4NB	ELTHAM 194 Court Road Mottingham Eltham London SE9 4EW	TONBRIDGE Unit 30 Deacon Trading Estate Morley Road Tonbridge TN9 1RA
HEREFORD Units 3 & 4 Bank Buildings Cattle market Hereford HE4 9HX	ENFIELD 284 Alma Road Enfield London EN3 7BB	
HIGHAM FERRERS 30 High Street Higham Ferrers Northants NN10 8PL	GRAVESEND Unit B4 Imperial Business Estate West Mill Gravesend Kent DA11 0DL	SOUTH WEST
ILKESTON Unit 2 Furnace Road Ilkeston DE7 5EP	IPSWICH Unit 6C Elton Park Business Centre Hadleigh Road Ipswich IP2 0DD	BARNSTAPLE Main Road Fremington Barnstaple North Devon EX31 2NT
LEICESTER Unit 7 Oaks Industrial Estate Coventry Road Narborough Leicestershire LE9 5GF	LETCHWORTH 16-17 Woodside Ind. Park Works Road Letchworth Herts SG6 1LA	BOURNEMOUTH 63-65 Curzon Road Bournemouth Dorset BH1 4PW
LINCOLN Unit 8 Clifton Street Stone Field Park Lincoln LN5 8LQ	LONDON 2 - 4 Royal Lane Yiewsley West Drayton Middlesex UB7 8DL	BRIDGEWATER 6 Herswell Business Park Salmon Parade Bridgwater Somerset TA6 5PY
NEWCASTLE UNDER LYME 18-21 Croft Road Brampton Ind. Estate Newcastle under Lyme Staffordshire ST5 0TW	MAIDENHEAD Reform Road Maidenhead Berkshire SL6 8BY	BRISTOL 11 Eldon Way Eldonwall Trading Estate Bristol BS4 3QQ
REDDITCH 13 Thornhill Road North Moons Moat Redditch Worcestershire B98 9ND	MOLESEY 10 Island Farm Avenue West Molesey Surrey KT8 2UZ	EMSWORTH 266 Main Road Southbourne Emsworth PO10 8JL
TAMWORTH Unit 3 Sterling Park Claymore Tamworth B77 5DQ	NEWBURY 9 Pipers Court Berkshire Drive Thatcham Berkshire RG19 4ER	ISLE OF WIGHT Unit 8 Enterprise Court Ryde Business Park Ryde Isle of Wight PO33 1DB
WORCESTER Units 1 & 2 Northbrooks Close Gregorys Mill Ind. Estate Worcester WR3 8BP	NORWICH 2b Trafalgar Street Norwich NR1 3HN	NEWTON ABBOT Unit 2 Zealley Ind. Estate Kingsteignton Newton Abbot TQ12 3TD
	SUNBURY Unit 1a The Summit Hanworth Road Sunbury on Thames TW16 5DB	REDRUTH Unit 7D Pool Ind. Estate Druids Road Redruth Cornwall TR15 3RH

# Instructions for the installer

Please examine the appliance for any damage. If the appliance is damaged contact your retailer before the appliance is connected.

Please keep packaging away from children and dispose of with due regard for the environment.

## Important Safety Requirements

- The hob must be installed by a qualified electrician / competent person.
- Damaged hobs with cracks or breakages in the ceramic glass must not be connected to the electrical supply.
- This hob must be installed in accordance with the IEE Wiring Regulations (Current Edition). Detailed recommendations are contained in the following British Standards Codes of Practice: B.S.6172 / B.S.5440 Part 2 and B.S.6891 Current Editions.

## Disposal



All packaging parts are recyclable, wooden strips are non-treated, foils and hard foam are marked. Packaging materials and old appliance should be disposed of at authorised disposal sites.

## Installation into the kitchen worktop



Protection against accidental contact according to the regulations set by VDE or other local authorities and EN60335 must be ensured by the correct installation of the appliance. The same refers to the back of the appliance which, even in the case of built-in solutions away from the wall, must not be freely accessible.

Built-in cupboards have to be located and fastened so that they are stable.

Measurement of:	
Worktop Opening	Appliance:
Width: 560mm	Width: 572mm
Depth: 490mm	Depth: 502mm
Corner Radius: 5mm	Height: 49mm
<b>Voltage:</b>	<b>AC 230 V 50 Hz/60Hz</b>
<b>Total Connection Load:</b>	<b>6.0kW</b>

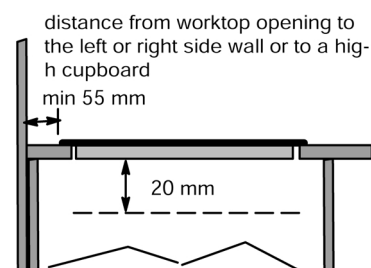
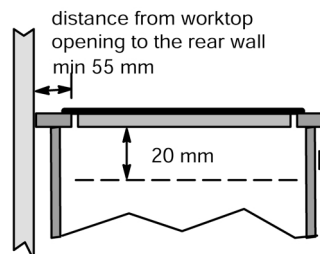
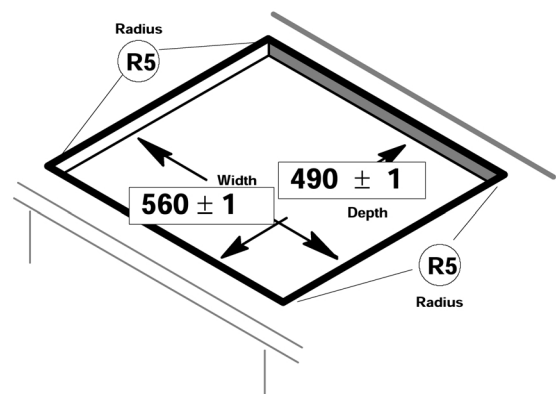

# Instructions for the installer

When building in ceramic glass cooking areas the front cross-rail of the build-in cupboard must be removed in order to have the heat radiating off escape without any obstacles.

The space under the hob unit must be closed at all sides in a way that the lower side of the cooking area is no longer accessible.

The distance from the hob to the furniture part under the hob must at least amount to 20 mm. If needed, please fix an insulation. Drawers must not be located under a hotplate.

The distance from the hob to a high cupboard beside right or left must at least amount 55 mm, to the back wall at least amount 55 mm.

With regard to the protection against overheating of surrounding furniture surfaces this appliance corresponds to type Y (EN 60335). This appliance or the built-in cupboard for the appliance respectively may be located with the rear wall and one side wall to whatever high walls or furniture respectively and with the other side to another appliance or furniture of the same height as this appliance.

## Built-in dimensions

The opening in the worktop must correspond to commercial dimensions. The hints required are given in the dimension sketch.

## Built-in

Cut out the worktop acc. to prescribed cutout size. The tolerance sizes must not be exceeded. Do precisely saw at the mark line. Recommendation: Mark the cut-out with a steel needle. Glue something on the line in order to avoid shattering of the coat when cutting.

With tile-coated worktop areas the slits in the supporting area for the cooking area must be filled up completely.

Clean the worktop in the cutout area.

From the top lay the cooking area into the cutout, adjust concentrically and firmly press down.

Check the sealing in the supporting frame for perfect seating and resting without a gap. Please do not apply additional silicone sealing material, the closure will make it harder to dismantle in case

of need for service, and may damage the worktop if removing the hob.

5 holes in the bottom of the built-in case are provided for the screws of the fitting plates.

At first screw on the fitting plates by a screwdriver and afterwards regularly tighten the plates alternatively and diagonally offset, until the frame of the cooking area is perfectly laying on the worktop.

Over-tightening must be avoided! Electric screwdrivers or pusher airscrews must be exclusively used with slip clutch (setting value 1 -- 1.1 Nm).

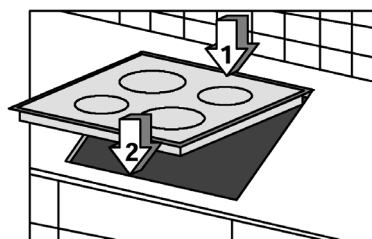
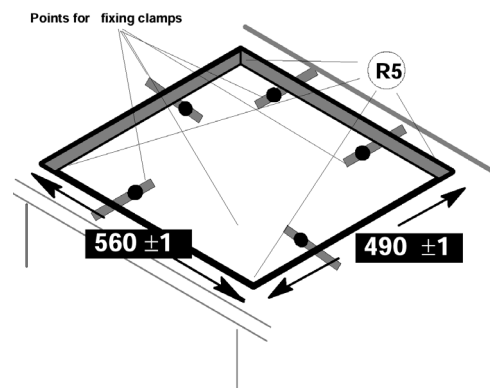
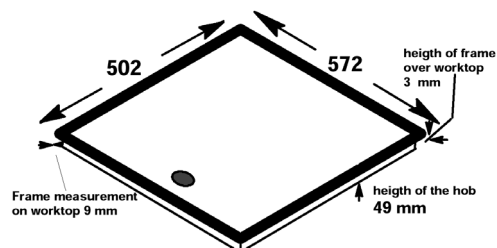

## Installation of hobs with fixing brackets

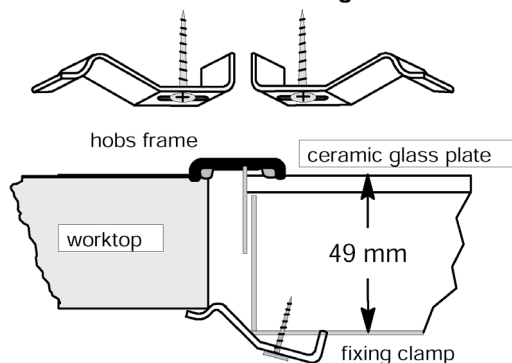

# Instructions for the installer

## Electrical Connection

The mains connection must be carried out by an expert electrician. The VDE-regulations and the valid prescriptions by the local power supply boards have to be compiled with.

Prior to connection it should be checked whether the voltage stated on the type plate - i.e. the nominal voltage of the appliance and of the oven/control box – is identical with the prevailing mains voltage. The rating plate is located on the hobs bottom.

The heating element voltage amounts to 230 V ~ . The appliance will also perfectly perform with the former mains voltage of 220 V ~ .

The mains connection must be carried out in a way that a double-pole switch is used with a contact opening of at least 3 mm, and disconnected by LS-automatism, earth-leakage circuit-breaker or fuse.

A wire of type H05VV-F or of higher rating is to be used as supply cable. The mains terminal is located in the bottom of the appliance behind a covering slide. It can be opened with a screw driver (pic.).

According to the existing mains voltage, the appliance must be connected in accordance with the appropriate connections as shown. The bridges of the terminal board are to be set in the marked position.

The protective conductor is to be connected to terminal 5. The protective conductor must be longer than live leads.

**The cable connections have to be established as prescribed and the terminal screws be firmly tightened.**

Afterwards the supply cable has to be secured by strain relief device and the covering slide must be closed by firmly pressing down.

Prior to first use remove any existing labels and protective foils from the ceramic glass plate or the frame of the hob.

After connection to the power supply check each cooking zone by briefly switching it the maximum setting (10).

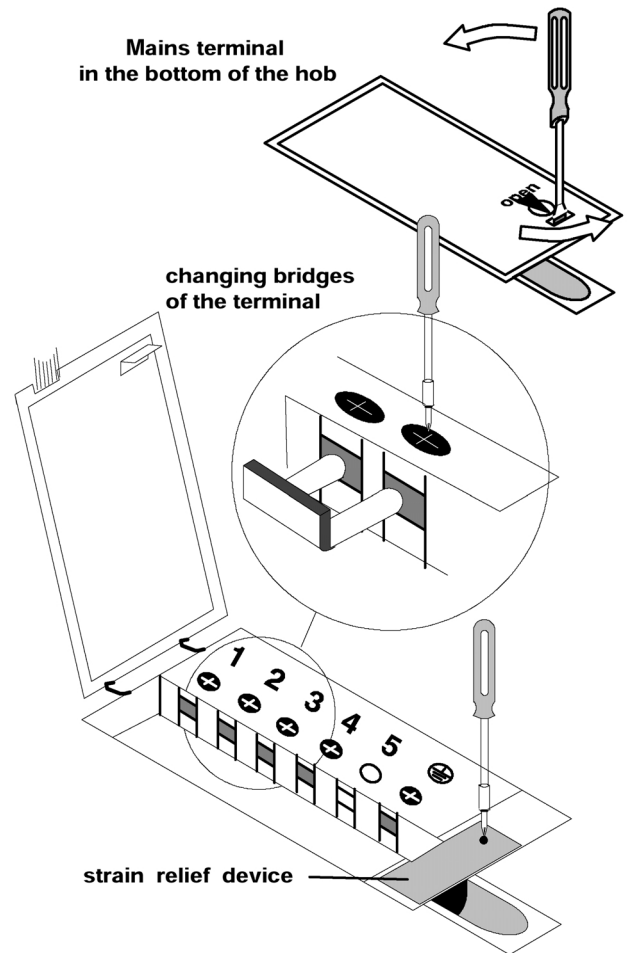

Connecting possibilities						
1	2	3	4	5	⊕	UK Only 230 V 1 L + N
—						
L1			N			
1	2	3	4	5	⊕	400 V 2 N 2 L + N
—		—				
L1		L2	N			
1	2	3	4	5	⊕	400 V 3 N 3 L + N
—		—				
L1	L2	L3	N			
1	2	3	4	5	⊕	230 V 2 2 L
—		—				
L1	(L3)		L2			
1	2	3	4	5	⊕	230 V 3 3 L
—		—				
L1		L2	L3			







## Free Manuals Download Website

<http://myh66.com>

<http://usermanuals.us>

<http://www.somanuals.com>

<http://www.4manuals.cc>

<http://www.manual-lib.com>

<http://www.404manual.com>

<http://www.luxmanual.com>

<http://aubethermostatmanual.com>

Golf course search by state

<http://golfingnear.com>

Email search by domain

<http://emailbydomain.com>

Auto manuals search

<http://auto.somanuals.com>

TV manuals search

<http://tv.somanuals.com>