

The Zanussi logo is positioned at the top right of the page. It consists of a horizontal grey bar that transitions from a darker shade on the left to a lighter shade on the right. The word "ZANUSSI" is written in a bold, black, sans-serif font across the right portion of this bar.

**ZANUSSI**

**REFRIGERATOR-  
FREEZER  
ZBB 7266**

**INSTRUCTION BOOKLET**



# IMPORTANT SAFETY INFORMATION

It is most important that this instruction book should be retained with the appliance for future reference. Should the appliance be sold or transferred to another owner, or should you move house and leave the appliance, always ensure that the book is left with the appliance in order that the new owner can get to know the functioning of the appliance and the relevant safety information.

This information has been provided in the interest of safety. You **MUST** read it carefully before installing or using the appliance.

## Installation

- This appliance is heavy. Care should be taken when moving it.
- It is dangerous to alter the specifications or attempt to modify this product in any way.
- Care must be taken to ensure that the appliance does not stand on the electrical supply cable.  
**Important:** if the supply cable is damaged, it must be replaced by a special cable available from your local Service Force Centre.
- Any electrical work required to install this appliance should be carried out by a qualified electrician or competent person.
- Parts which heat up should not be exposed.  
The back of the appliance should be close to a solid wall but leaving the required distance for ventilation as stated in the installation instructions.
- The appliance should be left for 2 hours after installation before it is turned on, in order to allow the refrigerant to settle.

## Child Safety

- This appliance is not intended for use by persons (including children) with reduced physical, sensory or mental capabilities, or lack of experience and knowledge, unless they have been given supervision or instruction concerning use of the appliance by a person responsible for their safety. Children should be supervised to ensure that they do not play with the appliance.
- Keep all packaging well away from children.

## General Safety

- **This appliance contains hydrocarbons in its cooling unit; maintenance and recharging must therefore only be carried out by authorised technicians.**
- **Take utmost care when handling your appliance so as not to cause any damages to the cooling unit with consequent possible fluid leakages.**
- **The appliance must not be located close to cookers, radiators or boilers.**
- **Avoid prolonged exposure of the appliance to direct sunlight.**
- **Do not use other electrical appliances (such as ice cream makers) inside of refrigerating appliances.**

## During Use

- This appliance is designed for domestic use only, specifically for the storage of edible foodstuffs.
- Frozen food must **NOT** be re-frozen once it has thawed out.
- Do not place carbonated or fizzy drinks in the freezer.
- Do not remove items from the freezer if your hands are damp/wet, as this could cause skin abrasions or frost/freezer burns.
- Ice lollies can cause 'frost/freezer burns' if consumed straight from the freezer.
- Manufacturers' storage recommendations should be strictly adhered to. Refer to relevant instructions.
- The cooling plate or refrigerated freezer shelves in this appliance contain channels through which the refrigerant passes. If these are punctured this will cause substantial damage to the appliance and result in food loss. **DO NOT USE SHARP INSTRUMENTS** to scrape off frost or ice. Under **NO** circumstances should solid ice be forced off the lining or shelves. Solid ice should be allowed to thaw, when defrosting the appliance. See Defrost Instructions.

## Maintenance and Cleaning

- Switch off and unplug the appliance before carrying out any cleaning or maintenance work.

## Servicing

- This product should be serviced by an authorised engineer and only genuine spare parts should be used.
- Under no circumstances should you attempt to repair the machine yourself. Repairs carried out by inexperienced persons may cause injury or serious malfunctioning. Refer to your local Service Force Centre and always insist on genuine spare parts.

# At the end of the Appliance Life

- When disposing of your appliance, use an authorised disposal site.
- Remove the plug and ensure that any locks or catches are removed, to prevent young children being trapped inside.

## CONTENTS

### Instructions for the User

<b>Important Safety Information</b>	2
<b>Operation</b>	4
Before using	4
Control panel	4
Display	4
Operation	4
Temperature indication	5
Activation of operation	5
Switching off	5
Use of the refrigerator-Setting the temperature	5
Shopping function	5
Fresh food refrigeration	5
Normal operating sounds	6
Use of the freezer -Setting the temperature	6
Freezing fresh food	6
Frozen food storage	7
Thawing	7
Making ice cubes	7
Cold accumulators	7
Excessive temperature alarm	7
Moveable shelves	8
Positioning the door shelves	8
Freezing calendar	8
<b>Hints and Tips</b>	9
<b>Maintenance and Cleaning</b>	10
Internal cleaning	10
When the appliance is not in use	10
Changing the light bulb	10
External cleaning	10
Defrosting	10
<b>Something Not Working</b>	11
<b>Service and Spare Parts</b>	12
<b>Customer Care</b>	12
<b>Guarantee Conditions</b>	13

### Disposal of old Appliances

The symbol  on the product or on its packaging indicates that this product may not be treated as household waste. Instead it shall be handed over to the applicable collection point for the recycling of electrical and electronic equipment. By ensuring this product is disposed of correctly, you will help prevent potential negative consequences for the environment and human health, which could otherwise be caused by inappropriate waste handling of this product. For more detailed information about recycling of this product, please contact your local city office, your household waste disposal service or the shop where you purchased the product.

### Instructions for the Installer

<b>Technical Specification</b>	14
<b>Installation</b>	15
Positioning	15
Shelf holders	15
<b>Electrical Connection</b>	16
<b>Door Reversal</b>	17

# OPERATION

## Before using

Remove all securing tapes. Wash inside the appliance with lukewarm water and bicarbonate of soda (5 ml to 0.5 litre of water).

**Do not use soap or detergent as the smell may linger. Dry thoroughly.**

## Control panel

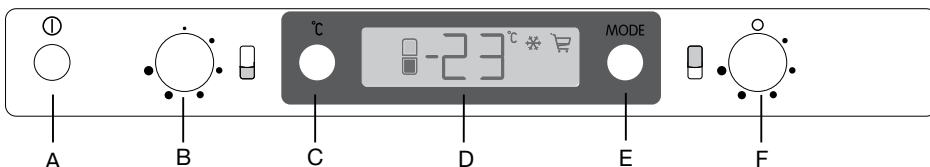

A - Appliance button ON/OFF

B - Freezer Thermostat control knob

C - Temperature indication button

D - Temperature and function indicator

E - Function button/ reset alarm

F - Fridge Thermostat control knob

## DISPLAY

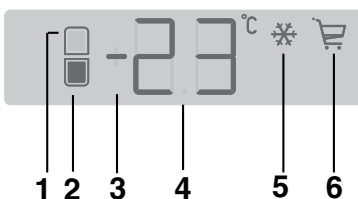

1. If on, the indicated temperature is that of the fridge compartment;

if it flashes, the alarm corresponds to the relative compartment.

2. If on, the indicated temperature is that of the freezer compartment;

if it flashes, the alarm corresponds to the relative compartment.

3. positive and negative Temperature indicator

4. Temperature indicator

5. If on, fast freeze function is on

6. If on, the shopping function is on

## Operation

After plugging the plug into the power outlet, if the display is not illuminated, press button (A), appliance on.

As soon as the appliance is turned on, the following signals will appear on the control panel:

- symbol (3) will be positive, indicating that the temperature is positive.
- the temperature flashes, the background of the display is red and you will hear a buzzer. Press button (E) and the buzzer will go off (also see the section on "excessive temperature alarm").

By turning the knob the display flashes and shows the desired temperature. For a correct storage of the food the following temperatures should be set:

+5°C in the fridge

-18°C in the freezer

### Important

If the door remains ajar for more than 7 minutes, the internal lighting will turn off electronically; after this, the lighting function will be reset by opening and closing the door itself.

## Temperature indication

In normal conditions, the display indicates the freezer temperature (symbol 2).

Each time button C is pressed, the display indicates in sequence:

1. symbol 1 turns on and indicator 4 shows the temperature of the fridge compartment;
2. symbol 2 turns on and indicator 4 shows the temperature of the freezer compartment.

In any case, after 10 seconds normal display conditions are restored.

## Use of the fridge compartment

### Setting the temperature

The temperature within the appliance is controlled by the thermostat control knob situated at the top of the appliance.

The temperature of this compartment may be regulated by rotating the knob (F), and may vary between more or less +2°C and +8°C.

When the knob is rotated, the display flashes and indicates the set temperature. After having set the desired temperature, if the knob is not rotated within 5 seconds, the temperature of the freezer compartment will be indicated.

To operate the appliance proceed as follows:

Turn the thermostat control beyond the «O» position.

Position ● = minimum coldness

Position ● = maximum coldness

Turn the thermostat dial to the required position.

**The intermediate position is usually the most suitable.**

The thermostat setting can vary as the temperature inside the appliance depends on the following factors:

- room temperature
- how often the door is opened
- how much food is stored
- position of the appliance

To shut off the refrigerator compartment, rotate the knob (F) anticlockwise till position "O". In this position the word "OF" is indicated for 5 seconds. The freezer compartment will keep on working.

We suggest placing the knob in the middle position to obtain an internal temperature of approximately +5° C.

Once the refrigerator compartment is shut off, the only temperature which is indicated is that of the freezer compartment.

## Activation of functions

Each time button E is pressed, the following functions are activated in a clockwise direction:

Symbol 5 : fast freeze function

Symbol 6 : shopping function

No Symbol: Normal operation

Not more than one function can be activated at a time; to de-activate the functions, press the button several times until no icon appears.

### Switching off

The appliance is shut off by pressing button (A) for more than 1 second. After this, a countdown of the temperature from -3 -2 -1 will be shown.

When the appliance is shut off, display (D) also goes off.

In this condition, the function shopping cannot be activated, and the lighting in the refrigerator compartment will be switched off.

**Important: If the fridge compartment is off, the door must be closed in order that the freezer is working properly .**

**In this condition, the electronic control of the appliance functions automatically and periodically circulating the air to prevent unpleasant smells and humidity .**

### Shopping Function

If you need to insert a large amount of warm food, for example after doing the grocery shopping, we suggest activating the Shopping function to chill the products more rapidly and to avoid warming the other food which is already in the refrigerator and/or freezer.

The shopping function is activated by pressing button E (several times if necessary) until the corresponding icon appears 

The shopping function shuts off automatically after approximately 6 hours.

It is possible to de-activate the function at any time by pressing button E (see paragraph "Function Activation").

### Fresh food refrigeration

To obtain the best performance, do not store warm food or evaporating liquids in the refrigerator; cover or wrap the food, particularly if it has a strong flavour.

Do not cover the shelves with any protective material, such as paper, cardboard or plastic, which may obstruct the air circulation.

To help you use your refrigerator correctly, here are some more useful hints:

Raw meat (beef, pork, lamb & chicken or poultry):

wrap in polythene bags and place on the glass shelf above the salad drawers.

**Meat can only be stored safely in this way for one or two days at the most.**

Fruit & vegetables: these should be thoroughly cleaned and placed in the salad drawers.

Butter & cheese: these should be placed in special airtight containers or wrapped in aluminium foil or polythene bags to exclude as much air as possible.

Milk bottles: these should have a cap and should be stored in the bottle rack on the door.

## Use of the freezer compartment

### Temperature control

The temperature within the freezer is controlled by the thermostat situated at the top of the cabinet.

The temperature of this compartment may be regulated by rotating the knob (B), and may vary between more or less  $-15^{\circ}\text{C}$  and  $-24^{\circ}\text{C}$ .

When the knob is rotated, the display flashes and indicates the set temperature. After having set the desired temperature, if the knob is not rotated within 5 seconds, the temperature of the freezer compartment will be indicated.

To operate the freezer proceed as follows:

Turn the thermostat control beyond the «•» position.

When you first start the freezer, we suggest that you turn the thermostat control to a medium setting.

However, if the appliance is working in unfavourable room conditions such as

- poor ventilation,
- high temperature,
- frequent door openings,

it may be necessary to select a more suitable setting.

We suggest setting the knob to the middle position to obtain an internal temperature of approximately  $-18^{\circ}\text{C}$ , which guarantees proper freezing and conservation of the frozen foods.

## Normal Operating Sounds

- You may hear faint gurgling or bubbling sounds when the refrigerator is pumped through the coils or tubing at the rear, to the cooling plate/evaporator.
- When the compressor is on, the refrigerant is being pumped round, and you will hear a whirring sound or pulsating noise from the compressor.
- A thermostat controls the compressor, and you will hear a faint 'click' when the thermostat cuts in and out.

### Freezing fresh food

The freezer compartment is suitable for long term storage of commercially frozen food, and for freezing fresh food.

The maximum quantity of foods to freeze in 24 hours is shown on the serial number plate.

Place the foods you want to freeze on the shelf of the freezer compartment, as this is the coldest point.

To freeze fresh foods, you will need to activate the fast freeze function. Press button E (several times if

necessary) until the corresponding icon appears ❄️

After a pre-cooling period of 24 hours, place the foods in the freezer.

The freezing process takes 24 hours. During this period do not put other foods in the freezer.

This function stops automatically after 54 hours.

Put the foods to be frozen in the compartments of the freezer, as per the diagram.

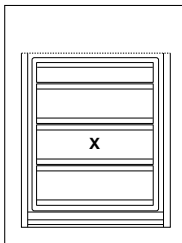

The function can be de-activated at any time by pressing button E (see paragraph "Activation of Functions").

Distribute the frozen food packages in the other compartments, so that the top compartments can be used for a further freezing operation.

- The food to be frozen must be fresh and of the best quality.
- Do not allow fresh food to touch food which is already frozen.
- During the freezing process, ensure that the freezer door remains closed.

## Frozen food storage

When you first start the freezer or if the freezer has been out of use for some time, we advise you to run your appliance for at least 24 hours in the «fast freeze» mode before storing frozen food.

Do not exceed the storage period indicated by the manufacturer.

Finally, do not open the door frequently or leave it open longer than is absolutely necessary.



### Warning

Do not put carbonated liquids, (fizzy drinks etc.), in the freezer compartment.

Water ices, if consumed immediately after removal from the freezer, can possibly result in a low temperature skin burn.

Do not remove items from the freezer if your hands are damp/wet, as this could cause skin abrasions or "frost/freezer burns".



### Important

In the event of a power cut the food in the freezer will not be affected if the power cut is short and if the freezer is full. Do not open the door. Should the food begin to thaw, it must be consumed quickly and must not be re-frozen .

## Thawing

Deep frozen or frozen food, prior to being used, can be thawed in the fridge or at room temperature depending on the time available. Small food items may even be cooked from frozen; in this case cooking will take longer.

Any frozen food which is allowed to thaw accidentally should either be eaten as soon as possible or thrown away. Alternatively, if the food is uncooked and has not been completely defrosted it can be cooked and then refrozen.

Meat, fish and fruit should be thawed in the refrigerator compartment and small pieces of meat can even be cooked while still frozen, but you must ensure that it is thoroughly cooked through.

Vegetables should be directly immersed in boiling water; ready-cooked dishes can be placed directly in the oven in their aluminium wrapping.

A microwave oven is particularly suitable for thawing any type of frozen or deep-frozen food: follow the oven instructions, particularly regarding the placement of aluminium wrapping or containers in the oven.

**Defrosted cooked food must never be refrozen.**

## Making ice cubes

The appliance is provided with one or more trays for ice-cubes trays.

Fill the tray(s) 3/4 full to give the ice space to expand and place them in the freezer compartment.

To release the ice cubes simply give the tray a slight twist.

Do not use sharp or metallic instruments to remove the trays from the freezer.

## Cold accumulators

The appliance is equipped with two cold accumulators. If there is a power outage, they will extend food conservation for a few hours.

## Excessive temperature alarm

An increase in the temperature in the freezer compartment (for example due to an power failure) is indicated by:

- flashing temperature;
- freezer compartment flashing (symbol 2);
- red illumination of display;
- sounding of buzzer.

When normal conditions are restored:

- the acoustic signal shuts off;
- the temperature value continues to flash;
- the display illumination remains red.

When you press button "E" to de-activate the alarm, the highest temperature reached in the compartment appears on indicator 4 for approximately 5 seconds. At this point the flashing stops and the display illumination changes over from red to white.

During the alarm phase, the buzzer can be switched off by pressing button E; the illumination of the display remains red until normal storage conditions are restored.

## Moveable shelves

The walls of the refrigerator have runners so that the shelves can be positioned as desired .

For better use of space, the front half-shelves can lie over the rear ones.

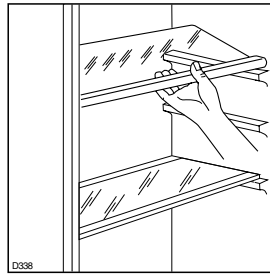

## Positioning the door shelves

To permit storage of food packages of various sizes, the door shelves can be adjusted in height. To make these adjustments proceed as follows:

Gradually pull the shelf in the direction of the arrows until it comes off, then reposition as required.

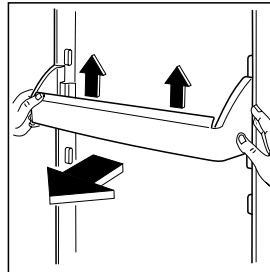
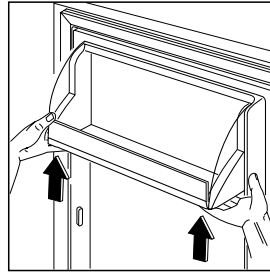

## Freezing Calendar



The symbols show different types of frozen goods.

The numbers indicate storage times in months for the appropriate types of frozen goods. Whether the upper or lower value of the indicated storage time is valid depends on the quality of the foods and pre-treating before freezing.



# HINTS AND TIPS

## Food Storage

- To obtain the best results from your appliance, neither hot foods nor liquids which may evaporate, should be placed in the larder compartment.
- Keep the time between buying chilled food and placing it in your fridge as short as possible.
- Do not push food together too much, try to allow air to circulate around each item.
- Do not store food uncovered.
- Remove suspect food from your refrigerator and clean, refer to 'Maintenance and Cleaning'.
- Ensure that food placed in the freezer is dated and labelled and used in date order to ensure that food is consumed at its best.
- Avoid buying frozen food if you cannot store it straight away. The use of an insulated container is advisable. When you arrive home place the frozen food in the freezer immediately.

## Energy Saving Advice

- Do not install the cabinet close to sources of heat, i.e. boiler or radiator.
- Locate the appliance in a cool well ventilated room and make sure that the air openings of the cabinet are not obstructed.
- Avoid unnecessary frosting in the cabinet by packing all foodstuffs into airtight packages before placing them in the freezer.
- Always leave warm food to cool down to room temperature before placing in the fridge or freezer.
- Food which is to be frozen (when cool) should be placed in the fridge before being transferred to the freezer.
- Thaw frozen food in the fridge. This will ensure safer defrosting of foods and reduce the work of the refrigeration unit.
- Try to avoid keeping the door open for long periods, or opening the door too frequently as warm air will enter the cabinet, and cause the compressor to switch on unnecessarily often.
- Ensure there are no obstructions preventing the door from closing properly.

## In the Event of a Power Failure

If there is a power failure during the storage of frozen foods, keep the door closed. If the temperature within your freezer should rise do not refreeze the food without checking its condition. The following guidelines should assist you.

### **Ice Cream:**

Once thawed should be discarded.

### **Fruit and Vegetables:**

If soft should be cooked and used up.

### **Bread and Cakes:**

Can be refrozen without danger.

### **Shellfish:**

Should be refrigerated and used up quickly.

### **Cooked Dishes:**

i.e. casseroles, should be refrigerated and used up.

### **Large Pieces of Meat:**

Can be re-frozen providing there are ice crystals remaining within them.

### **Small Joints:**

Should be cooked and then re-frozen as cooked dishes.

### **Chicken:**

Should be cooked and re-frozen as a fresh dish.

# MAINTENANCE AND CLEANING

Before any maintenance or cleaning work is carried out, DISCONNECT the appliance from the ELECTRICITY supply.

## Internal cleaning

Clean the inside and accessories with warm water and bicarbonate of soda (5ml to 0.5 litre of water). Rinse and dry thoroughly.

**Important :** Insert the 2 upper shelves in the original position after leaving them for cleaning .



**NEVER USE DETERGENTS, ABRASIVE POWDERS, HIGHLY PERFUMED CLEANING PRODUCTS OR WAX POLISHES, TO CLEAN THE INTERIOR AS THESE WILL DAMAGE THE SURFACE AND LEAVE A STRONG ODOUR.**

## When the appliance is not in use

When the appliance is not in use for long periods, disconnect from the electricity supply, empty all foods and clean the appliance, leaving the doors ajar to prevent unpleasant smells.

## External cleaning

**Many proprietary kitchen surface cleaners contain chemicals that can attack/damage the plastics used in this appliance. For this reason it is recommended that the outer casing of this appliance is only cleaned with warm water with a little washing-up liquid added.**

An accumulation of dust will affect the performance of the appliance and cause excessive electricity consumption.

You **MUST** ensure that the appliance is switched OFF.

Once or twice a year dust the condenser (black grill) and the compressor at the back of the appliance, with a brush or vacuum cleaner, see diagram.

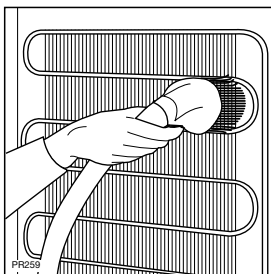

## Changing the light bulb

Should the interior light fail to work, first switch off the appliance and disconnect from the electricity supply, then replace the bulb as follows;

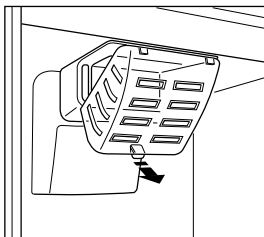

press on the rear hook and at the same time slide the cover in the direction indicated by the arrow. Unscrew the bulb and replace it with one of the same power (the maximum power is shown on the light diffuser) available from your nearest Service Force Centre. Replace the light cover by sliding it into its original position.

## Defrosting

### Refrigerator

The refrigerator automatically defrosts. The water is discharged, via the pipe, into a tray located at the back of the appliance above the compressor, where it evaporates.

### Freezer

Your appliance is frost free, which means there is no need to manually defrost your appliance as this will be carried out automatically.

# SOMETHING NOT WORKING

**Important:** If you call out an engineer to a fault listed below, or to repair a fault caused by incorrect use or installation a charge will be made, even if the appliance is under guarantee.

**Before** contacting your local Service Force Centre, check the following points:

Symptom	Solution
No power to the appliance	Check there is power at the socket.
	Check there is not a power cut by checking the household lights.
	Check the fuse has not blown.
The light does not come on	Ensure that the bulb is correctly fitted.
	Replace the bulb if it has blown.
	Check the door light switch is not jammed.
The temperature in the fridge or freezer section is too high	Check the thermostat control knob in the fridge is turned to the correct setting relative to ambient conditions.
	Check the ambient temperature is within the appliance's operating limits, please refer to the installation section in this instruction book. Relocate the appliance if necessary.
The freezer door will not open	Has door just been opened? If so leave for a few minutes to allow the air pressure to equalise.
The compressor runs continuously	Adjust the thermostat control knob to give correct temperature control. See "Setting the temperature".
	Check that the doors are closed.
	Large quantities of food have recently been placed in the cabinet and/or door is frequently opened.
	Check that air ventilation is not obstructed.
Excessive frost and ice has built up	Ensure the doors are not left open.
	Check that nothing is preventing the doors from closing.
	Is the door gasket intact and clean.
Noise	Refer to normal operating sounds.

# SERVICE AND SPARE PARTS

In the event of your appliance requiring service, or if you wish to purchase spare parts, please contact your local Zanussi Service Force Centre by telephoning:-

**0870 5 929929**

Your telephone call will be automatically routed to the Service Force Centre covering your post code area.

For the address of your local Service Force Centre and further information about Service Force, please visit the website at [www.serviceforce.co.uk](http://www.serviceforce.co.uk)

Before calling out an engineer, please ensure you have read the details under the heading 'Something Not Working?'

When you contact the Service Force Centre you will need to give the following details:

1. Your name, address and post code
2. Your telephone number
3. Clear and concise details of the fault
4. The model and serial number of the appliance (found on the rating plate)
5. The purchase date

**Please note that a valid purchase receipt or guarantee documentation is required for in-guarantee service calls.**

## CUSTOMER CARE DEPARTMENT

For general enquiries concerning your Zanussi appliance or for further information on Zanussi products, please contact our Customer Care Department by letter or telephone at the address below or visit our website at [www.zanussi.co.uk](http://www.zanussi.co.uk)

Customer Care Department

Major Appliances

Zanussi

Addington Way

Luton

Bedfordshire

LU4 9QQ

Tel: 08705 727 727 ( \* )

\* calls to this number may be recorded for training purposes.

# GUARANTEE CONDITIONS

## Standard guarantee conditions

We, Zanussi, undertake that if within 12 months of the date of the purchase this Zanussi appliance or any part thereof is proved to be defective by reason only of faulty workmanship or materials, we will, at our option repair or replace the same FREE OF CHARGE for labour, materials or carriage on condition that:

The appliance has been correctly installed and used only on the electricity supply stated on the rating plate.

The appliance has been used for normal domestic purposes only, and in accordance with the manufacturer's instructions.

The appliance has not been serviced, maintained, repaired, taken apart or tampered with by any person not authorised by us.

All service work under this guarantee must be undertaken by a Zanussi Service Force Centre. Any appliance or defective part replaced shall become the Company's property.

This guarantee is in addition to your statutory and other legal rights.

Home visits are made between **8.30am and 5.30pm** Monday to Friday. Visits may be available outside these hours in which case a **premium** will be charged.

## Exclusions

### This guarantee does not cover:

Damage or calls resulting from transportation, improper use or neglect, the replacement of any light bulbs or removable parts of glass or plastic.

Costs incurred for calls to put right an appliance which is improperly installed or calls to appliances outside the European Community (EC) or European Free Trade Area.

Appliances found to be in use within a commercial environment, plus those which are subject to rental agreements.

Products of Zanussi manufacture which are not marketed by Zanussi.

## European Guarantee

If you should move to another country within Europe then your guarantee moves with you to your new home subject to the following qualifications:

The guarantee starts from the date you first purchased your product.

The guarantee is for the same period and to the same extent for labour and parts as exists in the new country of use for this brand or range of products.

This guarantee relates to you and cannot be transferred to another user.

Your new home is within the European Community (EC) or European Free Trade Area.

The product is installed and used in accordance with our instructions and is only used domestically, i.e. a normal household.

The product is installed taking into account regulations in your new country.

Before you move please contact your nearest Customer Care centre, listed below, to give them details of your new home. They will then ensure that the local Service Organisation is aware of your move and able to look after you and your appliances.

France	Senlis	+33 (0)3 44 62 29 29
Germany	Nürnberg	+49 (0)800 234 7378
Italy	Pordenone	+39 (0)0434 39 4700
Sweden	Stockholm	+46 (0)8 672 53 90
UK	Luton	+ 44 ( 0) 8705 727727

# TECHNICAL SPECIFICATIONS

---

POWER SUPPLY VOLTAGE AND FREQUENCY	230-240 V / 50 Hz
TOTAL POWER ABSORBED	160 W
AVERAGE DAILY UNITS ELECTRICITY *	0.91 kWh

---

GROSS CAPACITY		
	Fridge	164 l
	Freezer	162 l

NET CAPACITY		
	Fridge	91 l
	Freezer	78 l

STAR RATING	
-------------	---

---

\* This figure is based on standard test results in accordance with European Standard EN 153.

Actual consumption will depend on how the appliance is used and where it is located.

# INSTALLATION

## Warning

IF YOU ARE DISCARDING AN OLD APPLIANCE THAT HAS A LOCK OR CATCH ON THE DOOR, YOU MUST ENSURE THAT IT IS MADE UNUSABLE TO PREVENT YOUNG CHILDREN BEING TRAPPED INSIDE.

Depending upon the position which you choose for your appliance, you may wish to reverse the way in which the door opens. To do this, refer to instructions on “Door reversal directions”.

## Positioning

This appliance should only be installed at a location where the ambient temperature corresponds to the climate classification indicated on the rating plate, which is located at the left on the inside of the appliance.

The following table shows which ambient temperature is correct for each climate classification:

SN +10°C to +32°C

N +16°C to +32°C

ST +18°C to +38°C

T +18°C to +43°C

It should be located in a dry atmosphere, out of direct sunlight and away from extreme temperature e.g. not next to a boiler or radiator, or in a very cold room e.g. an outhouse . If these temperatures are exceeded i.e. colder or warmer, then the appliance may not operate correctly.

For building-in and door reversibility, if necessary , refer to the relevant instructions in the following pages.

## Shelf holders

Your appliance is equipped with shelf retainers that make it possible to secure the shelves during transportation.

To remove them proceed as follows:

Raise the shelf from the back, push it in the direction of the arrow until it is freed and remove the retainers.

## Important

It must be possible to disconnect the appliance from the mains power supply; the plug must therefore be easily accessible after installation.

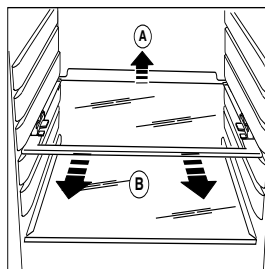

## **Electrical connections**

Any electrical work required to install this appliance should be carried out by a qualified electrician or competent person.

**WARNING: THIS APPLIANCE MUST BE EARTHED.**

**The manufacturer declines any liability should this safety measure not be observed.**

If the plug that is fitted to your appliance is not suitable for your socket outlet, it must be cut off and the appropriate plug fitted.

Remove the fuse from the cut off plug.

The cut off plug should then be disposed of to prevent the hazard of shocks in case it should be plugged into a 13amp socket in another part of your home.

## **Important**

The wires in the mains lead are coloured in accordance with the following code:

**Green and Yellow** - Earth  
**Blue** - Neutral  
**Brown** - Live

If you fit your own plug, the colours of the wires in the mains lead of your appliance may not correspond with the markings identifying the terminals in your plug, proceed as follows:

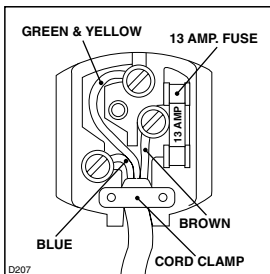

Connect the Green and Yellow (earth) wire to the terminal in the plug which is marked with the letter «E» or the earth symbol  $\oplus$  or coloured green and yellow.

Connect the blue (neutral) wire to the terminal in the plug which is marked with the letter «N» or coloured black.

Connect the brown (live) wire to the terminal in the plug which is marked with the letter «L» or coloured red.

The plug moulded onto the lead incorporates a fuse. For replacement, use a 13amp BSI362 fuse. Only ASTA or BSI approved fuses should be used.

The plug must not be used if the fuse cover/carrier is lost. The cover/carrier is indicated by the coloured insert at the base of the plug.

A replacement cover/carrier must be obtained from your local Service Force Centre.

**This appliance complies with the E.E.C. Directive No. 87/308 of 2.6.87 relative to radio interference suppression.**

 This appliance complies with the following E.E.C. Directives:

- **73/23 EEC of 19.2.73** (Low Voltage Directive) and subsequent modifications;
- **89/336 EEC of 3.5.89** (Electromagnetic Compatibility Directive) and subsequent modifications.

**Please ensure that when the appliance is installed it is easily accessible for the engineer in the event of a breakdown.**





## Instructions for totally built-in appliances

### Door reversal



The appliance is supplied with the right or left door opening. To change the opening direction of the door proceed as in the following instructions before installing it.

1. Unscrew the upper pin and remove the spacer.
2. Remove the upper pin and the upper door.
3. Unscrew the middle hinge.
4. Remove the lower door.
5. Unscrew the lower pin and refit it on the opposite side.
6. Refit the lower door.
7. Rescrew the middle hinge und the covers on the opposite side.
8. Refit the upper door and rescrew the hinge pin and the spacer on the opposite side.

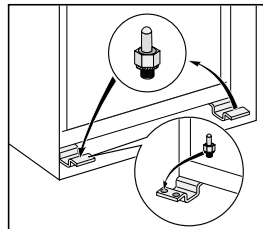
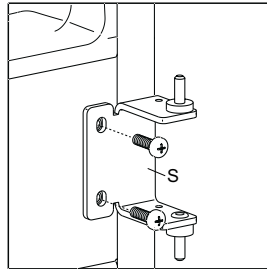
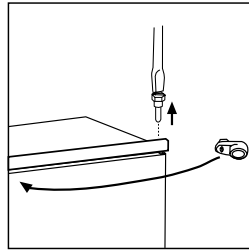

### Recess dimensions

Height	(1)	1780 mm
Depth	(2)	550 mm
Width	(3)	560 mm

To ensure adequate ventilation, allow the clearances shown in figure.

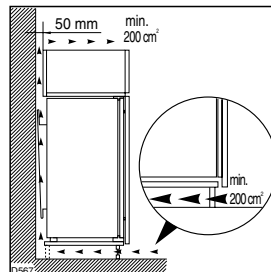

Furthermore, it is necessary that the cabinet has a ventilation recess with the following dimensions:

depth	50 mm
width	540 mm

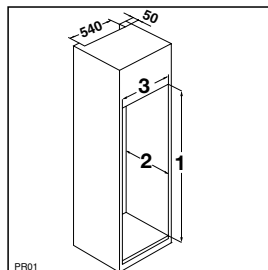

Make sure that a distance of 44 mm is maintained in the lower part between the kitchen furniture and the border of the appliance.

The lower hinge cover inserted in the accessories bag, is useful to guarantee the exact position of the kitchen furniture and the appliance.

Also make sure that the appliance does not clamp the mains cable

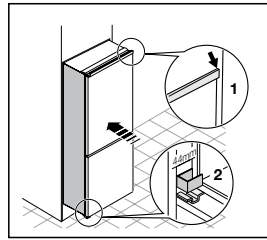

Fasten the appliance with 4 screws provided in the kit included with the appliance.

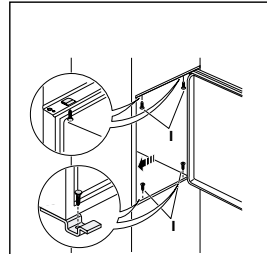

Apply the sealing strip pushing it between the refrigerator and the adjacent cabinet.

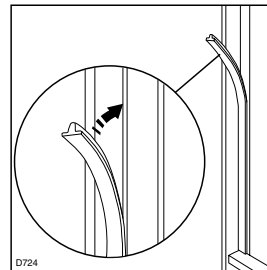

From the plastic cover (E), which is used to cover the hinge with the pivot pin, you must take away the part as indicated in the drawing.

This operation is made easier since there is, in the internal part of the cover hinge lid a groove that facilitates the removal of this component.

“Remove the part marked with DX, if the pivot pin is inserted in the right hinge, SX in opposite case.”

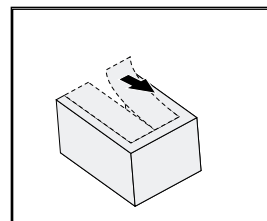

Apply covers (C-D) on joint cover lugs and into hinge holes.

Snap vent grille (B) and hinge covers (E) into position.

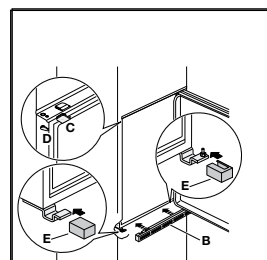

Separate parts Ha, Hb, Hc, Hd as shown in the figure.

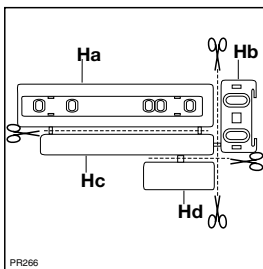

Place guide (Ha) on the inside part of the furniture door, up and down as shown in the figure and mark the position of external holes. After having drilled holes, fix the guide with the screws supplied.

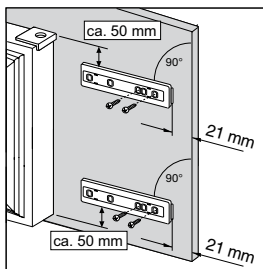

Fix cover (Hc) on guide (Ha) until it clips into place

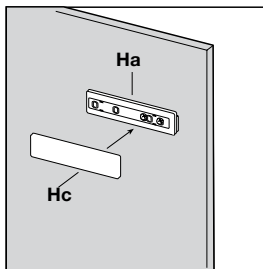

Open the appliance door and the furniture door at 90°. Insert the small square (Hb) into guide (Ha).

Put together the appliance door and the furniture door and mark the holes as indicated in the figure.

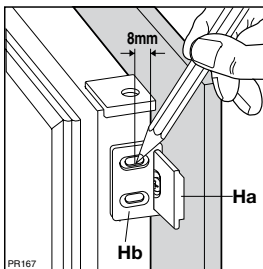

Remove the brackets and mark a distance of 8 mm from the outer edge of the door where the nail must be fitted (K).

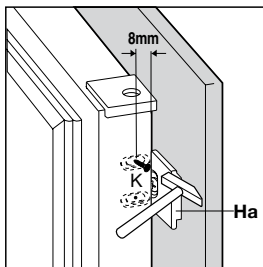

Place the small square on the guide again and fix it with the screws supplied.

Should the lining up of the furniture door be necessary, use the clearance of slots.

At the end of operations, it is necessary to check if the door of the furniture closes properly.

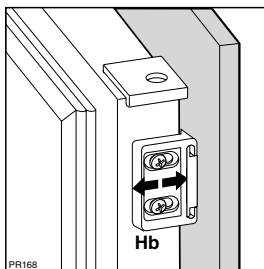

Fix cover (Hd) on guide (Hb) until it clips into place.

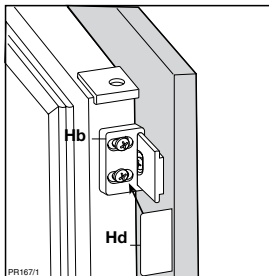

Fix the appliance to the side of the kitchen unit, fit the bracket (E) and (F), adjust the distance, and fix using the screws (as in figure). Fit the cover (D).

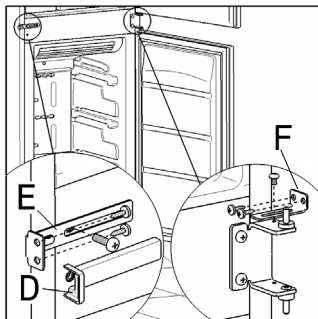

**After completion of the door reversing operation, check that the door gasket adheres to the cabinet. If the ambient temperature is cold (i.e. in Winter), the gasket may not fit perfectly to the cabinet. In that case, wait for the natural fitting of the gasket or accelerate this process by heating up the part involved with a normal hairdryer on a low setting.**







**[www.electrolux.com](http://www.electrolux.com)**

[www.zanussi-electrolux.co.uk](http://www.zanussi-electrolux.co.uk)

© Electrolux plc 2008



## Free Manuals Download Website

<http://myh66.com>

<http://usermanuals.us>

<http://www.somanuals.com>

<http://www.4manuals.cc>

<http://www.manual-lib.com>

<http://www.404manual.com>

<http://www.luxmanual.com>

<http://aubethermostatmanual.com>

Golf course search by state

<http://golfingnear.com>

Email search by domain

<http://emailbydomain.com>

Auto manuals search

<http://auto.somanuals.com>

TV manuals search

<http://tv.somanuals.com>