

EN User manual

Fridge-Freezer

USER MANUAL

ZRT318W

la vita è bella
ZANUSSI

ITALIAN SINCE 1916

This Quick user manual contains all the basic facts of your new product and is easy to use. Electrolux wants to lower our paper consumption related to user manuals by some 30%, which will help spare 12,000 trees every year. The Quick user manual is one of many steps taken by Electrolux for the environment. It may be a small step, but just by doing a little you do a lot.

A complete user manual can be found at www.electrolux.com

Safety information

In the interest of your safety and to ensure the correct use, before installing and first using the appliance, read this user manual carefully, including its hints and warnings. To avoid unnecessary mistakes and accidents, it is important to ensure that all people using the appliance are thoroughly familiar with its operation and safety features. Save these instructions and make sure that they remain with the appliance if it is moved or sold, so that everyone using it through its life will be properly informed on appliance use and safety.

For the safety of life and property keep the precautions of these user's instructions as the manufacturer is not responsible for damages caused by omission.

Children and vulnerable people safety

- This appliance is not intended for use by persons (including children) with reduced physical, sensory or mental capabilities, or lack of experience and knowledge, unless they have been given supervision or instruction concerning use of the appliance by a person responsible for their safety. Children should be supervised to ensure that they do not play with the appliance.
- Keep all packaging well away from children. There is risk of suffocation.
- If you are discarding the appliance pull the plug out of the socket, cut the connection cable (as close to the appliance as you can) and remove the door to prevent playing children to suffer electric shock or to close themselves into it.
- If this appliance featuring magnetic door seals is to replace an older appliance having a spring lock (latch) on the door or lid, be sure to make that spring lock unusable before you discard the old appliance. This will prevent it from becoming a death trap for a child.

General safety

-  **Caution!** Keep ventilation openings clear of obstruction.

- The appliance is designed exclusively for domestic use.
- The appliance is intended for keeping foodstuff and/or beverages in a normal household as explained in this instruction booklet.
- Do not use a mechanical device or any artificial means to speed up the thawing process.
- Do not use other electrical appliances (such as ice cream makers) inside of refrigerating appliances, unless they are approved for this purpose by the manufacturer.
- Do not damage the refrigerant circuit.
- The refrigerant isobutane (R600a) is contained within the refrigerant circuit of the appliance, a natural gas with a high level of environmental compatibility, which is nevertheless flammable. During transportation and installation of the appliance, be certain that none of the components of the refrigerant circuit become damaged. If the refrigerant circuit should become damaged:
 - avoid open flames and sources of ignition
 - thoroughly ventilate the room in which the appliance is situated
- It is dangerous to alter the specifications or modify this product in any way. Any damage to the cord may cause a short-circuit, fire and/or electric shock.

 **Warning!** Any electrical component (power cord, plug, compressor) must be replaced by a certified service agent or qualified service personnel.

1. Power cord must not be lengthened.
2. Make sure that the power plug is not squashed or damaged by the back of the appliance. A squashed or damaged power plug may overheat and cause a fire.
3. Make sure that you can come to the mains plug of the appliance.
4. Do not pull the mains cable.

5. If the power plug socket is loose, do not insert the power plug. There is a risk of electric shock or fire.
 6. You must not operate the appliance without the lamp cover¹⁾ of interior lighting.
- This appliance is heavy. Care should be taken when moving it.
 - Do not remove nor touch items from the freezer compartment if your hands are damp/wet, as this could cause skin abrasions or frost/freezer burns.
 - Avoid prolonged exposure of the appliance to direct sunlight.
 - Bulb lamps²⁾ used in this appliance are special purpose lamps selected for household appliances use only. They are not suitable for household room illumination.

Daily Use

- Do not put hot pot on the plastic parts in the appliance.
- Do not store flammable gas and liquid in the appliance, because they may explode.
- Do not place food products directly against the air outlet on the rear wall.³⁾
- Frozen food must not be re-frozen once it has been thawed out.
- Store pre-packed frozen food in accordance with the frozen food manufacturer's instructions.
- Appliance's manufacturers storage recommendations should be strictly adhered to.
- Do not place carbonated or fizzy drinks in the freezer compartment as it creates pressure on the container, which may cause it to explode, resulting in damage to the appliance.
- Ice lollies can cause frost burns if consumed straight from the appliance.

Care and cleaning

- Before maintenance, switch off the appliance and disconnect the mains plug from the mains socket.
- Before using the appliance for the first time, wash the interior and all internal accessories with lukewarm water and some neutral soap so as to remove the typical smell of a brand-new product, then dry thoroughly.

1) If the lamp cover is foreseen

2) If the lamp is foreseen

3) If the appliance is Frost Free

4) If a water connection is foreseen

- Do not clean the appliance with metal objects.
- Do not use sharp objects to remove frost from the appliance. Use a plastic scraper.
- Never use a hair drier or other heating appliances to speed up defrosting. Excessive heat may damage the plastic interior, and humidity could enter the electric system making it live.
- Regularly examine the drain in the refrigerator for defrosted water. If necessary, clean the drain. If the drain is blocked, water will collect in the bottom of the appliance.

Installation

Important! For electrical connection carefully follow the instructions given in specific paragraphs.

- Unpack the appliance and check if there are damages on it. Do not connect the appliance if it is damaged. Report possible damages immediately to the place you bought it. In that case retain packing.
- It is advisable to wait at least four hours before connecting the appliance to allow the oil to flow back in the compressor.
- Adequate air circulation should be around the appliance, lacking this leads to overheating. To achieve sufficient ventilation follow the instructions relevant to installation.
- Wherever possible the back of the product should be against a wall to avoid touching or catching warm parts (compressor, condenser) to prevent possible burn.
- The appliance must not be located close to radiators or cookers.
- Make sure that the mains plug is accessible after the installation of the appliance.
- Connect to potable water supply only.⁴⁾

Service

- Any electrical work required to do the servicing of the appliance should be carried out by a qualified electrician or competent person.
- This product must be serviced by an authorized Service Centre, and only genuine spare parts must be used.

Environment Protection

 This appliance does not contain gasses which could damage the ozone layer, in either its refrigerant circuit or insulation materials. The appliance shall not be discarded together with the urban refuse and rub-

bish. The insulation foam contains flammable gases: the appliance shall be disposed according to the applicable regulations to obtain from your local authorities. Avoid damaging the cooling unit, especially at the rear near the heat exchanger. The materials used on this appliance marked by the symbol  are recyclable.

Operation

Switching on

Insert the plug into the wall socket.
Turn the Temperature regulator clockwise to a medium setting.

Switching off

To turn off the appliance, turn the Temperature regulator to the "O" position.

Temperature regulation

The temperature is automatically regulated.
To operate the appliance, proceed as follows:

- turn the Temperature regulator toward lower settings to obtain the minimum coldness.
- turn the Temperature regulator toward higher settings to obtain the maximum coldness.

Daily use

Freezing fresh food

The freezer compartment is suitable for freezing fresh food and storing frozen and deep-frozen food for a long time.

To freeze fresh foods it is not necessary to change the medium setting.

However, for a faster freezing operation, turn the temperature regulator toward higher settings to obtain the maximum coldness.

Important! In this condition, the refrigerator compartment temperature might drop below 0°C. If this occurs reset the temperature regulator to a warmer setting.

Storage of frozen food

When first starting-up or after a period out of use, before putting the products in the compartment let the appliance run at least 2 hours on the higher settings.

 A medium setting is generally the most suitable.

However, the exact setting should be chosen keeping in mind that the temperature inside the appliance depends on:

- room temperature
- how often the door is opened
- the quantity of food stored
- the location of the appliance.

Important! If the ambient temperature is high or the appliance is fully loaded, and the appliance is set to the lowest temperatures, it may run continuously causing frost to form on the rear wall. In this case the dial must be set to a higher temperature to allow automatic defrosting and therefore reduced energy consumption.

Important! In the event of accidental defrosting, for example due to a power failure, if the power has been off for longer than the value shown in the technical characteristics chart under "rising time", the defrosted food must be consumed quickly or cooked immediately and then re-frozen (after cooling).

Thawing

Deep-frozen or frozen food, prior to being used, can be thawed in the refrigerator compartment or at room temperature, depending on the time available for this operation.

Small pieces may even be cooked still frozen, directly from the freezer: in this case, cooking will take longer.

Care and cleaning

⚠ Caution! Unplug the appliance before carrying out any maintenance operation.

🌿 This appliance contains hydrocarbons in its cooling unit; maintenance and recharging must therefore only be carried out by authorized technicians.

Many proprietary kitchen surface cleaners contain chemicals that can attack/damage the plastics used in this appliance. For this reason it is recommended that the outer casing of this appliance is only cleaned with warm water with a little washing-up liquid added.

After cleaning, reconnect the equipment to the mains supply.

Defrosting of the refrigerator

Frost is automatically eliminated from the evaporator of the refrigerator compartment every time the motor compressor stops, during normal use. The defrost water drains out through a trough into a special container at the back of the appliance, over the motor compressor, where it evaporates.

It is important to periodically clean the defrost water drain hole in the middle of the refrigerator compartment channel to prevent the water overflowing and dripping onto the food inside. Use the special cleaner provided, which you will find already inserted into the drain hole.

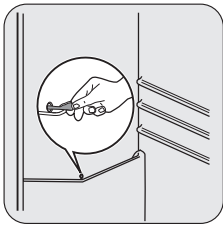

What to do if...

Normal Operating Sounds

- You may hear a faint gurgling and a bubbling sound when the refrigerant is pumped through the coils or tubing. This is correct.
- When the compressor is on, the refrigerant is being pumped around and you will hear a whirring sound and a pulsating noise from the compressor. This is correct.

Defrosting the freezer

i A certain amount of frost will always form on the freezer shelves and around the top compartment.

Important! Defrost the freezer when the frost layer reaches a thickness of about 3-5 mm.

To remove the frost, do these steps:

1. Switch off the appliance.
2. Remove any stored food, wrap it in several layers of newspaper and put it in a cool place.
3. Leave the door open.
4. When defrosting is completed, dry the interior thoroughly and refit the plug.
5. Switch on the appliance.
6. Set the temperature regulator to obtain the maximum coldness and run the appliance for two or three hours using this setting.
7. Reload the previously removed food into the compartment.

Important! Never use sharp metal tools to scrape off frost from the evaporator as you could damage it. Do not use a mechanical device or any artificial means to speed up the thawing process other than those recommended by the manufacturer. A temperature rise of the frozen food packs, during defrosting, may shorten their safe storage life.

- The thermic dilatation might cause a sudden cracking noise. It is natural, not dangerous physical phenomenon. This is correct.
- When the compressor switches on or switches off, you will hear a faint "click" of the temperature regulator. This is correct.

Technical data

Dimension		
	Height	1209 mm
	Width	496 mm
	Depth	604 mm
Rising Time		17 h

The technical information are situated in the rating plate on the internal left side of the appliance and in the energy label.

Installation

⚠ Caution! Read the "Safety Information" carefully for your safety and correct operation of the appliance before installing the appliance.

Positioning

This appliance can be installed in a dry, well ventilated indoor (garage or cellar) also, but for optimum performance install this appliance at a location where the ambient temperature corresponds to the climate class indicated on the rating plate of the appliance:

Climate class	Ambient temperature
SN	+10°C to + 32°C
N	+16°C to + 32°C
ST	+16°C to + 38°C
T	+16°C to + 43°C

Rear spacers

In the bag with the documentation, there are two spacers which must be fitted as shown in the figure.

1. Fit the spacers into the holes. Make sure that the arrow (A) is positioned as shown in the picture.
2. Turn counter-clockwise the spacers through 45° until they lock into place.

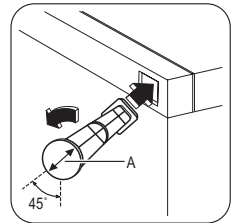

Levelling

When placing the appliance ensure that it stands level. This can be achieved by two adjustable feet at the bottom in front.

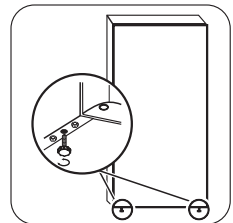

Location

The appliance should be installed well away from sources of heat such as radiators, boilers, direct sunlight etc. Ensure that air can circulate freely around the back of the cabinet. To ensure best performance, if the appliance is positioned below an overhanging wall unit, the minimum distance between the top of the cabinet and the wall unit must be at least 100 mm. Ideally, however, the appliance should not be positioned below overhanging wall units. Accurate levelling is ensured by one or more adjustable feet at the base of the cabinet.

If the cabinet is placed in a corner and the side with the hinges facing the wall, the distance between the wall and the cabinet must be at least 10 mm to allow the door to open enough so that the shelves can be removed.

Warning!

It must be possible to disconnect the appliance from the mains power supply; the plug must therefore be easily accessible after installation.

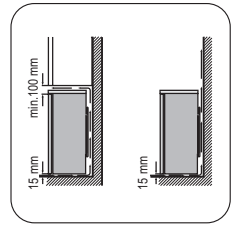

Door reversibility

Important! To carry out the following operations, we suggest that this be made with another person that will keep a firm hold on the doors of the appliance during the operations.

To change the opening direction of the door, do these steps:

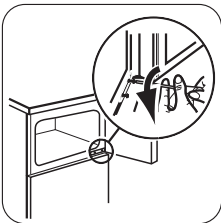

1. Remove the plug from the power socket.
2. Open the door of the freezer. Loosen the hinge.

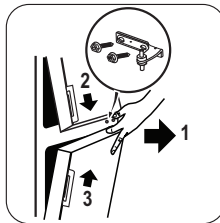

3. Remove the doors by pulling them slightly and remove the hinge.

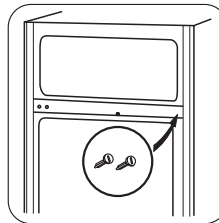

4. On the opposite side, remove the hole covers.

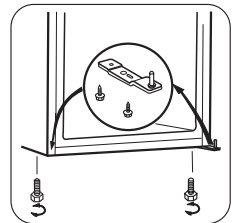

5. Unscrew both adjustable feet and the screws of the bottom door hinge. Remove the bottom door hinge and install it on the opposite side.

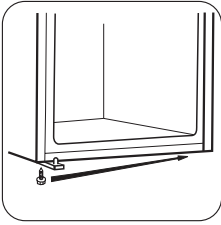

6. Unscrew the bottom far side screw and install on the opposite side.

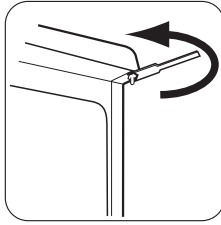

7. Unscrew the top door holding pin.

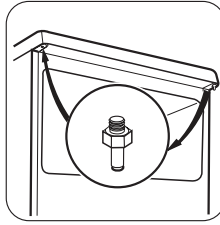

8. Screw the pin back on the other side.

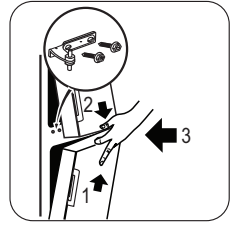

9. Fit the doors into the pins and install the doors. Install the hinge.

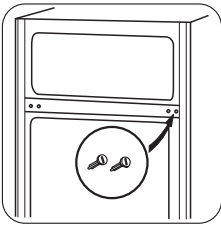

10. On the opposite site, install the hole covers provided within the accessory bag.

11. Tighten the hinge. Make sure that the doors are aligned.

12. Remove and install the handle¹⁾

13. Reposition, level the appliance, wait for at least four hours and then connect it to the power socket.

1) If foreseen

Do a final check to make sure that:

- All screws are tightened.
- The door opens and closes correctly.

If the ambient temperature is cold (i.e. in Winter), the gasket may not fit perfectly to the cabinet. In that case, wait for the natural fitting of the gasket.

In case you do not want to carry out the above mentioned operations, contact the nearest After Sales Service Force. The After Sales Service specialist will carry out the reversibility of the doors at your cost.

Electrical Connection

⚠ Caution! Any electrical work required to install this appliance should be carried out by a qualified electrician or competent person.

⚠ Warning! This appliance must be earthed. The manufacturer declines any liability should these safety measures not be observed.

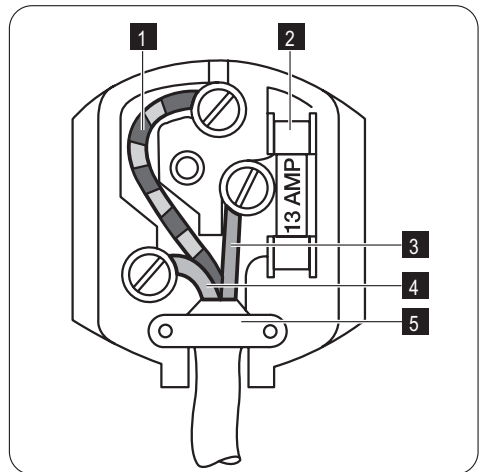

Important! The wires in the mains lead are coloured in accordance with the following code:

- | | |
|---------------------|---------|
| 1 Green and Yellow: | Earth |
| 3 Brown: | Live |
| 5 Blue: | Neutral |

As the colours of the wires in the mains lead of this appliance may not correspond with the coloured markings identifying the terminals in your plug, proceed as follows:

1. Connect the wire coloured green and yellow to the terminal marked either with the letter "E" or by the earth symbol  or coloured green and yellow.
2. Connect the wire coloured blue to the terminal either marked with the letter "N" or coloured black.
3. Connect the wire coloured brown to the terminal either marked with the "L" or coloured red.

Environmental concerns

The symbol  on the product or on its packaging indicates that this product may not be treated as household waste. Instead it should be taken to the appropriate collection point for the recycling of electrical and electronic equipment. By ensuring this product is disposed of correctly, you will help prevent

4. Check that no cut, or stray strands of wire is present and the cord clamp **4** is secure over the outer sheath.
5. Make sure the electricity supply voltage is the same as that indicated on the appliance rating plate.
6. Switch on the appliance.

The appliance is supplied with a 13 amp plug fitted

- 2**. In the event of having to change the fuse in the plug supplied, a 13 amp ASTA approved (BS 1362) fuse must be used.

 **Warning!** A cut off plug inserted into a 13 amp socket is a serious safety (shock) hazard. Ensure that it is disposed of safely.

potential negative consequences for the environment and human health, which could otherwise be caused by inappropriate waste handling of this product. For more detailed information about recycling of this product, please contact your local council, your household waste disposal service or the shop where you purchased the product.



www.zanussi.com/shop



200383436-01-04062010

Free Manuals Download Website

<http://myh66.com>

<http://usermanuals.us>

<http://www.somanuals.com>

<http://www.4manuals.cc>

<http://www.manual-lib.com>

<http://www.404manual.com>

<http://www.luxmanual.com>

<http://aubethermostatmanual.com>

Golf course search by state

<http://golfingnear.com>

Email search by domain

<http://emailbydomain.com>

Auto manuals search

<http://auto.somanuals.com>

TV manuals search

<http://tv.somanuals.com>