

INSTRUCTION BOOKLET

**ZANUSSI**

**COOKER HOOD  
ZHC 590**

Thank you for buying a Zanussi product.

To enable you to use your appliance effectively and safely, please read this instruction book carefully before using the appliance and retain for future reference. If you require guidance in the use of the appliance or require further information on Zanussi Products, please contact our Customer Services Department. For general enquiries concerning your Zanussi appliance or for further information, visit our website at <http://www.zanussi.co.uk>

Customer Services Department  
Major Appliances  
Zanussi  
Addington Way  
Luton  
Bedfordshire  
LU4 9QQ

Tel: 08705 727 727\*

\*Calls to this number may be recorded for training purposes.

To register ownership, please ensure you complete and return the guarantee card supplied with the appliance.

## For the User

### Important Safety Information

### Your Appliance

### Operating Instructions

Cooker Hood Controls  
To Operate  
Recirculation  
Extraction

### Maintenance and Cleaning

External Cleaning  
Metal Grease Filters  
Charcoal Filters  
To Remove/Replace Charcoal Filter  
Changing the Halogen Light

### Something Not Working

### Service and Spare Parts

### Guarantee Conditions

## For the Installer

Technical Information

### Electrical Connections

Electrical Requirements  
Electrical Connection

### Installing the Cooker Hood

Installation Requirements  
Unpacking  
Fitting the Wall Brackets  
Fitting the Canopy Hood  
Venting  
Recirculation  
Fitting the Chimney Stack

## Guide to use the instruction book

The following Symbols will be found in the text to guide you through the instruction book



Safety instructions



Step by step instructions

# IMPORTANT SAFETY INFORMATION

These warnings are provided in the interests of your safety. Ensure that you understand them all before installing or using this appliance. Your safety is of paramount importance. If you are unsure about any of the meanings of these warnings contact the Customer Services Department.

## ■ Installation

- Any installation work must be undertaken by a qualified electrician or a competent person.
- This hood must be installed in accordance with the installation instructions and all measurements must be adhered to.
- If the cooker hood is installed for use above a gas appliance then the provision for ventilation must be in accordance with the Gas Safety Codes of Practice BS.6172, BS.5440 and BS.6891 (Natural Gas) and BS.5482 (LP Gas) 1994, the Gas Safety (Installation & Use) Regulations, the Building Regulations issued by the Department of the Environment, the Building standards (Scotland) (Consolidated) Regulations issued by the Scottish Development Department.
- The fan motor of this cooker hood incorporates a cut-out device which will operate if the cooker hood is installed below the minimum height recommended under section 'Clearance Height', or if the motor becomes overheated. If the cut-out device is activated, switch off the fan motor and allow the cooker hood to cool. The cut-out device will reset itself when the fan motor has cooled significantly.
- It is dangerous to alter the specifications or modify this product in any way.
- When installed between adjoining wall cabinets the wall cabinets must not overhang the hob.
- If the room where the hood is to be used contains a fuel burning appliance such as a central heating boiler then its flue must be of the room sealed or balanced flue type.
- If other types of flue or appliances are fitted ensure that there is an adequate supply of air to the room.
- The ducting system for this appliance must not be connected to any existing ventilation system which is being used for any other purpose.
- Do not install above a cooker with a high level grill.

## ■ Child Safety

- This appliance is designed to be operated by adults. Children should not be allowed to tamper with the controls or play with the appliance.

## ■ During Use

- This product is for domestic use only.
- Never leave frying pans unattended during use as over-heated fats and oils might catch fire.
- Never do flambé cooking under this cooker hood.
- Do not leave naked flames under the hood.
- This cooker hood is designed to extract unpleasant odours from the kitchen, it will not extract steam.

## ■ Maintenance and Service

- This appliance can be a hazard if the synthetic paper and charcoal filters are not replaced as recommended.
- Under no circumstances should you attempt to repair the appliance yourself. Repairs carried out by inexperienced persons may cause injury or more serious malfunction. Refer to your local Zanussi Service Force Centre. Always insist on genuine spare parts.

# YOUR APPLIANCE

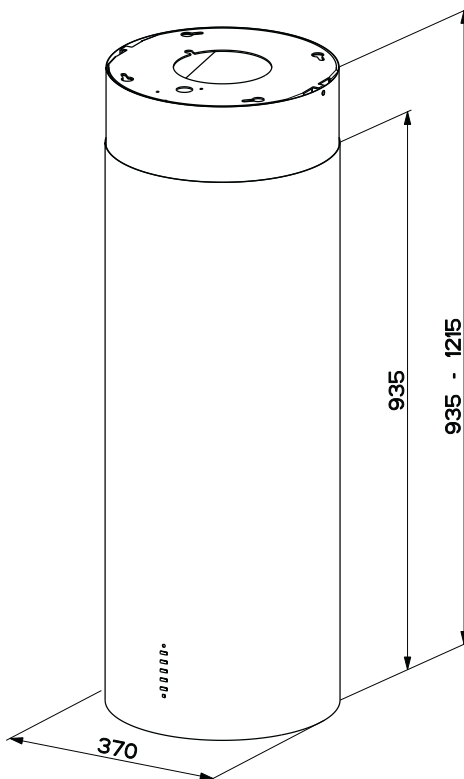
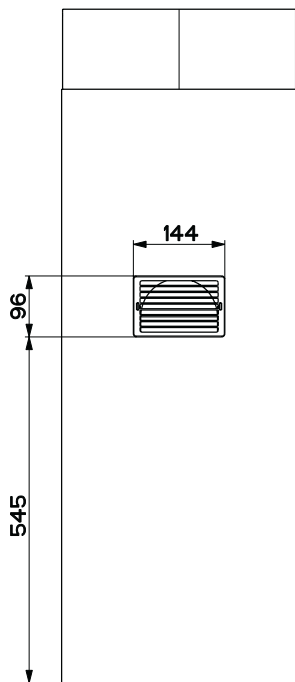

# OPERATING INSTRUCTIONS

The cooker hood is designed to extract unpleasant odours from the kitchen, it will not extract steam. The appliance can be installed to recirculate or extract contaminated air.

## Control Panel

The hood can be switched on pushing directly onto the requested speed without firstly having to select 0/1 button.

| KEY       | LED          | FUNCTIONS   |
|-----------|--------------|---|
| <b>L</b>  | 0/1 Light    | Turns lighting on and off.  |
| <b>T1</b> | 0/1 Motor on | First speed.<br>When pressed for about 1 seconds the motor is switched off.   |
| <b>T2</b> | Speed on     | Second speed.   |
| <b>T3</b> | Speed on     | Third speed.  |
| <b>T4</b> | Speed Fixed  | Max. speed.   |
|           | Flashing     | Intensive speed.<br>Suitable for the strongest cooking vapours and odours. The function becomes active when the button is pushed for about 2 seconds. After 10 minutes of functioning it turns off automatically. This function can be interrupted by means of pressing any of the buttons.                         |
| <b>S1</b> | Led Fixed    | Indicates that the Metal grease filters saturation alarm has been triggered, and the filters need to be washed. The alarm is triggered after 100 working hours. ( <i>Reset; check the Maintenance-paragraph</i> )   |
|           | Flashing     | indicates that the activated charcoal odour filter saturation alarm has been triggered, and the filter has to be replaced; the metal grease filters must also be washed. The activated charcoal odour filter is triggered after 200 working hours. ( <i>Activation and Reset; check the Maintenance-paragraph</i> ) |

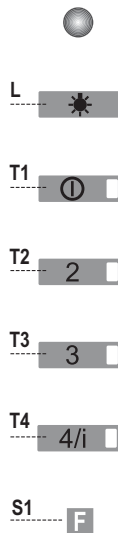

# OPERATING INSTRUCTIONS

## To Operate

Select the required fan speed and light if required.

## Recirculation

In the recirculation mode the contaminated air enters the cooker hood through the grease filters. The air is cleaned by passing through the charcoal filters before being passed back into the kitchen through the grilles in either side of the chimney stack.

## Extraction

In the extraction mode the contaminated air enters the cooker hood passing through the grease filters and is passed out through the ducting into the atmosphere. To obtain the best performance when cooking it is advisable to switch the cooker hood on for a few minutes before you start cooking and leave it running for about 15 minutes after finishing.



*When used in the ducting mode the charcoal filters are not required.*

*Never do flambé cooking under this cooker hood.*

*Never leave frying pans unattended during use, as over-heated fats and oils can catch fire.*

*Do not leave naked flames under the cooker hood.*

*Ensure heating areas on your hob are covered with pots and pans when using the hob and cooker hood simultaneously.*

# MAINTENANCE AND CLEANING

 Before carrying out any maintenance or cleaning isolate the cooker hood from the mains supply.

*The cooker hood must be kept clean, as a build up of grease or fat can be a fire hazard.*

## External Cleaning

Wipe the cooker hood frequently with warm soapy water using a mild detergent.

 Never use scouring pads or abrasive cleaners. Never use excessive amounts of water when cleaning particularly around the control panel.

## Metal Grease Filters

The filters are washable and must be cleaned when the **Led S1** lights up or at least every 2 months of operation, or more frequently for particularly heavy usage.

### Remove the metal grease filters one at a time by:

- Open the lighting unit by pulling on the notch.
- Releasing the catches on the filters, the filters can be removed.

The metal grease filters should be washed, by hand, in mild soapy water or in a dishwasher. Allow to dry completely before replacing.

### Alarm signal reset

Switch off the lights and extractor motor. Press Button **T3** for at least 3 seconds, until the leds start to flash.

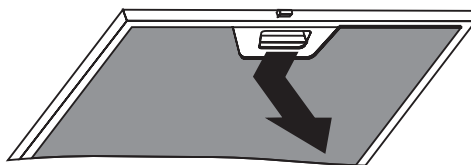
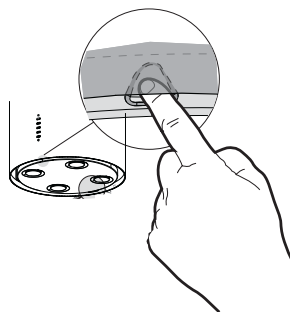

281\_06

# MAINTENANCE AND CLEANING

 Before carrying out any maintenance or cleaning isolate the cooker hood from the mains supply.

## Charcoal Filters

In the recirculation mode the charcoal filters absorb smells and unwanted odours.

### Enabling the alarm signal

- In Recirculation version Hoods, the Filter saturation alarm can be enabled on installation or at a later date.
- Turn the Lights and the suction Motor off.
- Disconnect the Hood using the Main switch or the double-pole switch on the mains power supply.
- Restore the connection by pressing and holding T1.
- Release the button. All five LEDs are turned on
- Within 3 seconds press T1 until LEDs T1 and T4 flash in confirmation:
  - LED flashes twice - Activated charcoal filter saturation alarm ENABLED
  - LED flashes once - Activated charcoal filter saturation alarm DISABLED

The filter is not washable and cannot be regenerated. It must be replaced when led S1 flashes or at least every 4 months. The alarm signal will only light up when the extractor motor is switched on.

### To Remove/Replace the Charcoal Filters

- Open the lighting unit by pulling on the notch.
- Remove the metal grease filters
- Remove the saturated activated carbon filter by releasing the fixing hooks
- Fit the new filter by hooking it into its seating
- Replace the metal grease filters.

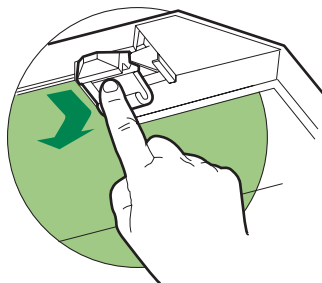

 This appliance can be a possible fire hazard if the grease and charcoal filters are not cleaned and replaced as recommended.

### Alarm signal reset

- Switch off the lights and extractor motor.
- Press button T3 for at least 3 seconds, until the leds start to flash.

### Changing the halogen light

- Remove the halogen lamp from the lamp holder by pulling gently.
- Replace the lamp with a new one of the same type, making sure that you insert the two pins properly into the housings on the lamp holder.

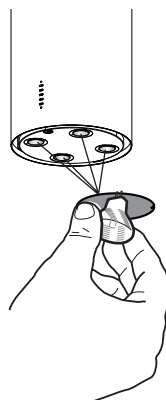

Replacement filters and halogen light can be obtained from your local Service Force Centre.



## SOMETHING NOT WORKING

If, having followed these instructions carefully, your cooker hood fails to work properly please carry out the following checks.

| Symptom   | Solution  |
|---|---|
| The cooker hood will not start                    | <ul style="list-style-type: none"><li>• Check the hood is connected to the electricity supply.</li><li>• Make sure the switch is in the 'ON' position.</li></ul>  |
| The cooker hood is not working effectively        | <ul style="list-style-type: none"><li>• The fan speed is set high enough for the task</li><li>• The grease filter is clean.</li><li>• The kitchen is adequately vented to allow the entry of fresh air.</li><li>• If set up for recirculation, check that the charcoal filter is still effective.</li><li>• If set up for extraction, check that the ducting and outlets are not blocked.</li></ul> |
| The cooker hood has switched off during operation | <ul style="list-style-type: none"><li>• The safety cut-out device has been tripped.</li><li>• Turn off the hob and then wait for the device to reset.</li></ul>   |

If after all these checks, the fault persists, contact your local Service Force Centre, quoting the model and serial number.

Please note that it will be necessary to provide proof of purchase for any in-guarantee service calls.

**In-guarantee customers should ensure that the above checks have been made as the engineer will make a charge if the fault is not a mechanical or electrical breakdown.**

## SERVICE AND SPARE PARTS

If you require an engineer or spare parts contact your local Service Force Centre by telephoning:

**08705 929929**

Your telephone call will be routed to your local Service Force Centre. For the address of your local Service Force Centre and further information about Service Force, please visit the website at [www.serviceforce.co.uk](http://www.serviceforce.co.uk)

For general assistance with your appliance or for further information on Zanussi products please contact our Customer Services Department.

Customer Services Department  
Major Appliances  
Zanussi  
Addington Way  
Luton  
Bedfordshire  
LU4 9QQ  
Tel: 08705 727 727 \*

\* calls to this number may be recorded for training purposes.

# GUARANTEE CONDITIONS

We Zanussi, undertake that if within twenty four months of the date of the purchase this Zanussi built-in appliance or any part thereof is proved to be defective by reason only of faulty workmanship or materials, the company will, at our option repair or replace the same FREE OF ANY CHARGE for labour, materials or carriage on condition that:

- The appliance has been correctly installed and used only on the electrical supply stated on the rating plate.
- The appliance has been used for normal domestic purposes only, and in accordance with the manufacturer's operating and maintenance instructions.
- The appliance has not been serviced, maintained, repaired, taken apart or tampered with by any person not authorised by us.
- All service work under this guarantee must be undertaken by Zanussi Service Force Centre.
- Any appliance or defective part replaced shall become the property of this company.

Home visits are made between **8.30am and 5.30pm Monday to Friday**. Visits may be available outside these hours in which case a premium will be charged.

## EXCLUSIONS

**This Guarantee does not cover:**

- Damage or calls resulting from transportation, improper use or neglect, the replacement of any light bulbs or removable parts of glass or plastic.
- Costs incurred for calls to put right appliances improperly installed or calls to appliances outside the United Kingdom.
- Appliances found to be in use within a commercial environment, plus those which are the subject of rental agreements.
- Products of Zanussi manufacture which are not marked by Zanussi.

This guarantee is in addition to your statutory and legal rights.

## ZANUSSI EUROPEAN GUARANTEE

If you should move to another country within Europe then your guarantee moves with you to your new home subject to the following qualifications:

- The guarantee starts from the date you first purchased your product.
- The guarantee is for the same period and to the same extent for labour and parts as exists in the new country of use for this brand or range of products.
- This guarantee relates to you and cannot be transferred to another user.
- Your new home is within the European Community (EC) or European Free Trade Area.
- The product is installed and used in accordance with our instructions and is only used domestically, i.e. a normal household.

**Before you move please contact your nearest Customer Care Centre, listed below, to give them details of your new home. They will then ensure that the local Service Organisation is aware of your move and able to look after you and your appliances.**

|         |           |                      |
|---------|-----------|----------------------|
| France  | Senlis    | +33 (0)3 44 62 22 22 |
| Germany | Nurnberg  | +49 (0)911 323 2600  |
| Italy   | Pordenone | +39 (0)1678 47053    |
| Sweden  | Stockholm | +46 (0)20 78 77 50   |
| UK      | Luton     | +44 (0)8705 727 727  |

# INSTALLATION INSTRUCTIONS



*It is dangerous to alter the specifications or attempt to modify this product in any way.*

## Technical Information

### DIMENSIONS

|                    |                 |        |
|--------------------|-----------------|--------|
| HEIGHT OF CANOPY:  |                 | 935 mm |
| HEIGHT OF CHIMNEY: | (UPPER SECTION) | 290 mm |
|                    | (LOWER SECTION) | 935 mm |
| WIDTH OF CANOPY :  |                 | 370 mm |
| DEPTH OF CANOPY:   |                 | 370 mm |

### ELECTRICAL SUPPLY:

|                    |            |       |
|--------------------|------------|-------|
| VOLTAGE:           | 220-240 V  | 50Hz  |
| POWER CONSUMPTION: |            | 410 W |
| FAN MOTOR:         |            | 330 W |
| LAMPS :            | (4 x 20 W) | 80 W  |



**Note: CE Marking certifies that this appliance complies with the requirements laid down in EEC directive 89:336. (Electromagnetic compatibility) and subsequent modifications and Low Voltage directive 72/23/E.**



The symbol  on the product or on its packaging indicates that this product may not be treated as household waste. Instead it shall be handed over to the applicable collection point for the recycling of electrical and electronic equipment. By ensuring this product is disposed of correctly, you will help prevent potential negative consequences for the environment and human health, which could otherwise be caused by inappropriate waste handling of this product. For more detailed information about recycling of this product, please contact your local city office, your household waste disposal service or the shop where you purchased the product.

## ELECTRICAL CONNECTIONS



**THIS APPLIANCE MUST BE EARTHED**

### Electrical Requirements

Any permanent electrical installation must comply with the latest I.E.E. Regulations and local Electricity Board regulations. For your own safety this should be undertaken by a qualified electrician e.g. your local Electricity Board, or a contractor who is on the roll of the National Inspection Council for Electrical Installation Contracting (NICEIC).

### Electrical Connection

Before connecting to the mains supply ensure that the mains voltage corresponds to the voltage on the rating plate inside the cooker hood.

This appliance is fitted with a 3 core mains cable and must be permanently connected to the electricity supply via a double-pole switch having 3mm minimum contact gap on each pole. A Switched Fuse Connection Unit to BS1363 Part 4, fitted with a 3 Amp fuse, is a recommended mains supply connection accessory to ensure compliance with the Safety Requirements applicable to fixed wiring instructions.

This appliance conforms to BS 800: 1988 and EEC Directive No. 78 308 regarding suppression of radio and television interference.

# INSTALLING THE COOKER HOOD

Please ensure that when the appliance is installed it is easily accessible to an engineer in the event of a breakdown.



All installations must comply with the local authorities requirements for the discharge of exhaust air. Incorrect installation may affect the safety of this cooker hood.

## Installation Requirements



Before installation check the wall to which the cooker hood is to be fitted for electric cables, water pipes or gas.

This cooker hood is designed to be fixed to any horizontal surface over a cooking area, and can be used in the extraction (ducted to the outside) or recirculation mode.

The installation work must be undertaken by a qualified and competent person.

The manufacturer disclaims any responsibility for damage due to incorrect installation of the cooker hood or if the hood is not installed in compliance with relevant regulations controlling this type of installation.

## Unpacking

Before unpacking the cooker hood position the carton with the arrows pointing upwards as illustrated on the carton.

The cooker hood is made up of the following components:

| Ref. | Q.ty | Product Components   |
|------|------|--|
| 1    | 1    | Hood Body, complete with: Controls, Light, Blower, Filters |
| 2    | 1    | Upper Chimney  |
| 7.1  | 1    | Telescopic frame complete with extractor, consisting of:   |
| 7.1a | 1    | Upper frame  |
| 7.1b | 1    | Lower frame  |
| 8    | 1    | Air Outlet Grill   |
| 9    | 1    | Reducer Flange $\varnothing$ 150-120 mm                    |
| 9a   | 1    | $\varnothing$ 120-125mm collar                             |
| 14.1 | 1    | Air Outlet Connection Extension                            |
| 14.2 | 1    | Air Outlet Extension                                       |
| 15   | 1    | Air Outlet Connection                                      |
| 25   | 2    | Pipe clamps  |

| Ref. | Q.ty | Installation Components |
|------|------|-------------------------|
| 12f  | 4    | Screws M6 x 15          |
| 21   | 1    | Drilling template       |

| Q.ty | Documentation      |
|------|--------------------|
| 1    | Instruction Manual |

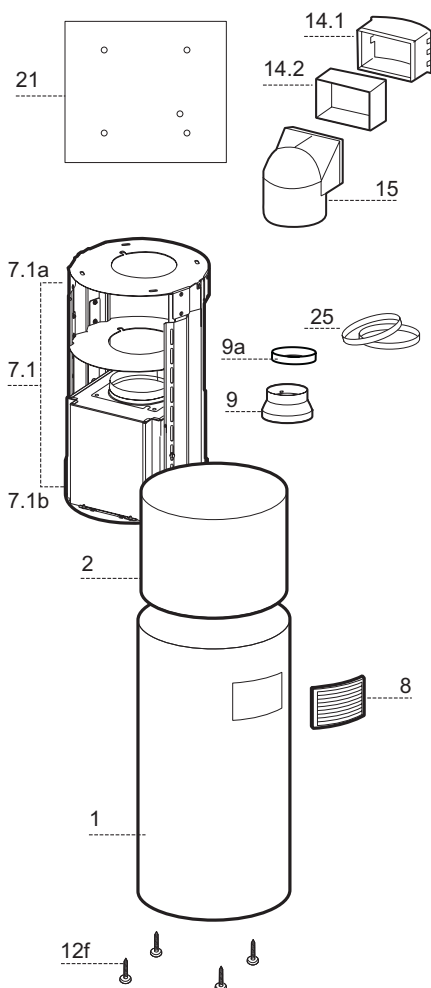

# INSTALLING THE COOKER HOOD

## Clearance Height

The cooker hood is designed to be fitted over a cooking appliance at the clearance heights stated, providing the maximum output of the appliance beneath does not exceed the maximums quoted in the Technical Specifications.

If the output of the appliance below the cooker hood exceeds the maximum outputs quoted, please refer to the cooker manufacturer's installation instructions.

A clearance height of 650mm (25 1/2 ") is required when installed above a built-in electric hob, or 700mm (27 1/2") when installed above a built-in gas hob.

A clearance height of 685mm (27") is required when installed above a slot-in electric cooker, or 787mm (30 1/2 ") when installed above a slot-in gas cooker.

When installed between adjoining wall cabinets, the wall cabinets must not overhang the hob and the distance between the underside of the cabinet and the worktop must be 450mm. If the height of the wall cabinet is less than 450mm, a gap of 50mm must be maintained either side of the hob.

 *This cooker hood must not be installed above a cooking appliance with a high level grill.*

The hood can be installed above these heights but for optimum performance it should be installed at the distances quoted for the appropriate heat source.

This appliance can be used in either extraction mode (ducting) or recycling mode (filtering).

The hood is supplied suitable for recirculation with the charcoal filters fitted.

When used in the extraction mode (ducting) the charcoal filters are not required and **must** be removed and destroyed.

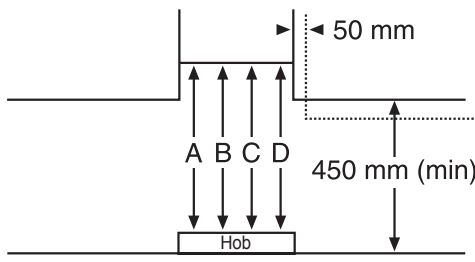

- |                             |                 |
|-----------------------------|-----------------|
| A: Built-in Electric Hob:   | 650mm clearance |
| B: Built-in Gas hob:        | 700mm clearance |
| C: Slot-in Electric Cooker: | 685mm clearance |
| D: Slot-in Gas Cooker:      | 787mm clearance |

# INSTALLING THE COOKER HOOD

## Drilling the Ceiling/Support Shelf

- Use a plumb line to mark the centre of the hob on the ceiling/support shelf.
- Place the drilling template **21** provided on the ceiling/support shelf, making sure that the template is in the correct position by lining up the axes of the template with those of the hob.
- Mark the centres of the holes in the template.
- Drill the holes at the points marked:
  - For concrete ceilings, drill for plugs appropriate to the screw size.
  - For hollow brick ceilings with wall thickness of 20 mm: drill  $\varnothing$  10 mm (immediately insert the Dowels not provided).
  - For wooden beam ceilings, drill according to the wood screws used.
  - For wooden shelf, drill  $\varnothing$  7 mm.
  - For the power supply cable feed, drill  $\varnothing$  10 mm.
  - For the air outlet (Ducted Version), drill according to the diameter of the external air exhaust duct connection.
- Insert two screws of the following type, crossing them and leaving 4-5 mm from the ceiling:
  - For concrete ceilings, use the appropriate plugs for the screw size (not provided).
  - For Cavity ceiling with inner space, with wall thickness of approx. 20 mm, Screws not provided.
  - For wooden beam ceilings, use 4 wood screws (not provided).
  - For wooden shelf, use 4 screws with washers and nuts (not provided)

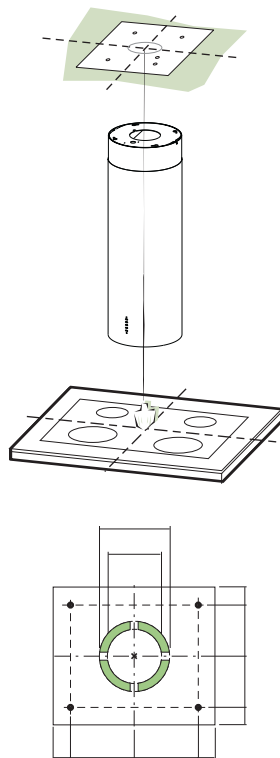

## Fixing the Frame

- Unfasten the two screws fastening the upper chimney stack **2.1** to the frame, and remove the chimney from the upper stack.

If you wish to adjust the height of the frame, proceed as follows:

- Unfasten the four safety screws located at the top in the frame separation area. **(A)**
- Unfasten the eight metric screws joining the two columns, located at the sides of the frame. **(B)**
- Adjust the frame to the height required, then replace all the screws removed as above.
- To guarantee greater stability in the frame, replace the four safety screws in the last hole available.
- Insert the upper chimney stack from above, and leave it running free on the frame.

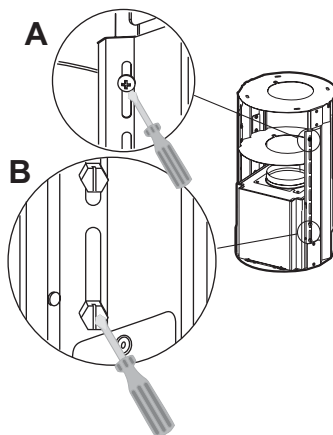

## INSTALLING THE COOKER HOOD

- Lift the frame up, making sure that the index over the frame plate is turned backwards.
- Fit the frame slots onto the two screws inserted in the ceiling as above, and turn until reaching the centre of the adjustment slot.
- Tighten the two screws and fasten the other two screws provided; before locking the screws completely, it is possible to adjust the frame by turning it, making sure that the screws do not come out of their housing in the adjustment slot.
- **The Frame must be securely fastened so as to support both the weight of the Hood and the stress caused by occasional axial pressure against the fitted Appliance. After fixing, make sure that the base is stable even when the Frame is subjected to lateral stress.**
- **If the Ceiling is not strong enough in the area where the hood is to be fixed, the Installer must strengthen the area using suitable plates and counterplates anchored to resistant structures.**

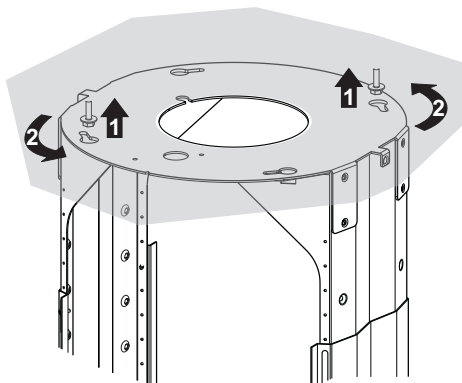

### Extraction

The cooker hood is more effective when used in the extraction mode (ducted to the outside).

**Venting kits may be purchased through your retailer or DIY store, and must be ducted to an outside vent of Ø125mm (5") or Ø150mm (6").**

For the best performance use the shortest possible duct run and the minimum number of bends.

Where flexible ducting is fitted it should not be turned through very tight bends as this may impair the performance of the hood.

It is recommended a maximum length of 3 metres with one bend, to be installed, to be reduced metre for each 90° bend.

If a distance is greater than 3 metres the efficiency of the hood could be impaired.

*The ducting used must be manufactured from fire retardant material conforming to the relevant British Standard or DIN 4102-B1.*

When the cooker hood is ducted to the outside the charcoal filter must be removed.

# INSTALLING THE COOKER HOOD

## Ducting Connection

Connect the ducting chosen to:

- the Ø150mm ducting spigot on top of the motor housing, or the Ø150-120mm ducting spigot **item 9** and secure using the jubilee clips **item 25**.
- A Ø120-125mm collar **item 9a** is provided to fit over the Ø120mm ducting spigot when 125mm ducting is fitted.

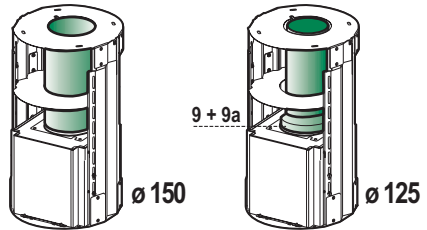

*If the room where the cooker hood is to be used contains a fuel burning appliance such as a central heating boiler, then its flue must be of the room sealed or balanced flue type.*

*If other types of flue or appliances are fitted sure that there is an adequate supply of air to the room.*

*The cooker ducting (extraction mode) must never be connected to central heating flues, radiators or water heaters etc.*

## Recirculation

The cooker hood is supplied specified for use in the recirculation mode, with the charcoal filter fitted.

In the recirculation mode contaminated air is passed through the charcoal filter to be purified and recirculated into the kitchen through the grille outlets on either side of the chimney.

## Recirculation Connection

- Insert reducer flange **9** on the extractor outlet.
- Push fit connector **15** onto the reducer flange.
- Insert extension piece **14.2** sideways into connector **15** making sure that the outlet corresponds with the mouth of the chimney

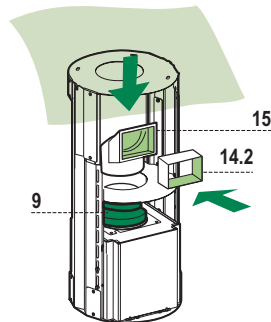



# INSTALLING THE COOKER HOOD

## Chimney Stack

The chimney consists of two sections.

The lower chimney measures (with the Hood body and recirculation grilles) 935 mm and the upper chimney measures 290 mm. The overall installed measurement is min. 935 - max 1215 mm.

### Fitting the Upper Chimney and the Hood Body

- Position the upper chimney stack and fix the top of it to the frame using 2 of the screws removed as above.
- Open the lighting unit by pulling on the notch, disconnect it from the hood canopy by sliding out the fixing pin.
- Remove the activated charcoal filters, if fitted.
- In order to fix the hood body to the frame insert the 4 screws **12f** in their seats. It is necessary to leave at least 4-5 mm gap between the screw heads and the frame plate.
- Hook the hood canopy to the frame and turn it to the left until it reaches the stop, then lock the screws immediately to prevent the hood canopy from falling out accidentally.
- Make sure that the outlet of the extension piece **14.1** is horizontally and vertically aligned with the chimney outlet.
- If this is not the case, remove the lower Chimney Stack and adjust the position of connector **15**; replace the elements as described above.
- Insert Connector Extension **14.1** sideways into Extension **14.2**.
- Fit the directional grill **8** into the housing provided. Also make sure that it is properly fitted into connector **14.1**.

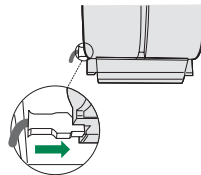
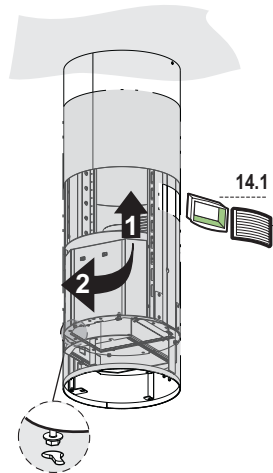
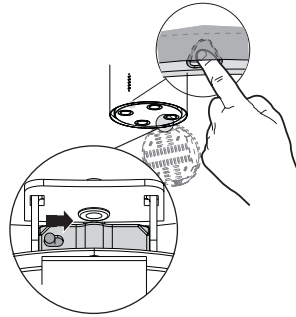

### Electrical Connection

- Ensure that the supply cable connector is properly inserted into the Suction device socket
- Hook up the Commands connector **Cmd**.
- Hook up the Spotlights connector **Lux** to the socket provided behind the lighting unit cover.
- For the recirculation version, fit the activated carbon odour filter.
- Replace the grease filters.
- Replace the lighting unit.

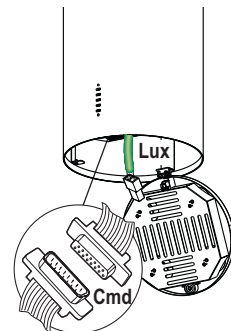

# Service and Spare Parts



In the event of your appliance requiring service, or if you wish to purchase spare parts please contact your local Service Force Centre by telephoning:

**08705 929929**

Your telephone call will be automatically routed to the Service Force centre covering your post code area.

For the address of your local Service Force Centre and further information about Service Force, please visit the website at [www.serviceforce.co.uk](http://www.serviceforce.co.uk)

Before calling out an engineer, please ensure you read the details under the heading Something not working.

When you contact the Service Force Centre you will need to give the following details:

1. Your name, address and post code
2. Your telephone number
3. Clear and concise details of the fault
4. The model and serial number (found on the rating plate)
5. The purchase date

**Please note that a valid purchase receipt or guarantee documentation is required for in-guarantee service calls.**

For Customer Service in Ireland please contact us at the address below:

Zanussi  
Electrolux Group (Irl) Ltd  
Long Mile Road  
Dublin 12  
Republic of Ireland  
Tel: + 353 (0)1 4090751  
Email: [service.eid@electrolux.ie](mailto:service.eid@electrolux.ie)

## Customer Care Department

For general enquiries concerning your Zanussi appliance or for further information on Zanussi products please contact our Customer Care Department by letter or telephone at the address below or visit our website at [www.zanussi.co.uk](http://www.zanussi.co.uk)

Customer Services Department  
Major Appliances  
Zanussi  
Addington Way  
Luton  
Bedfordshire  
LU4 9QQ  
Tel: 08705 727 727 \*

\* calls to this number may be recorded for training purposes.





Dir. 89/336/CEE  
73/23/CEE  
93/68/CEE

© Electrolux plc 2002

436002645\_04 - 060303

## Free Manuals Download Website

<http://myh66.com>

<http://usermanuals.us>

<http://www.somanuals.com>

<http://www.4manuals.cc>

<http://www.manual-lib.com>

<http://www.404manual.com>

<http://www.luxmanual.com>

<http://aubethermostatmanual.com>

Golf course search by state

<http://golfingnear.com>

Email search by domain

<http://emailbydomain.com>

Auto manuals search

<http://auto.somanuals.com>

TV manuals search

<http://tv.somanuals.com>