

IA1

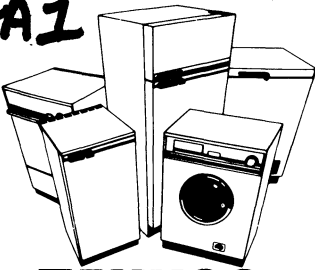

ZANUSSI

CUSTOMER SERVICE
LIBRARY
MASTER COPY

Instructions for the use and care of WD 2290 washing machine & tumble dryer

Contents

Technical data

Installation

Unpacking	Page 3
Positioning & levelling	Page 3
Water connection	Page 4
Electrical connection	Page 5

Operation

Controls description	Page 6
Loading the clothes	Page 7
Filling with washing powder	Page 7
Use of additives	Page 7
Which powder?	Page 8
Selection of washing programme	Page 8
Starting	Page 8
Stopping	Page 9
Drying	Page 9
Wash cycle	Page 10/11
Fabrics drying times	Page 12

Care and cleaning

Cleaning the machine	Page 12
Cleaning the drain filter	Page 12
Hints for care of washing powder dispenser	Page 13
Helpful tips for washing	Page 13
Servicing	Page 14

Width	23.6 ins (600 mm)
Overall depth (excluding hose)	23.6 ins (600 mm)
Height	33.5 ins (850 mm)
Weight	198,5 lbs (90 kg)
Dry clothes capacity (excluding synthetic fabrics and wool)	10 lbs (4,5 kg)
Revolutions during spinning	800 r.p.m.
Total power absorbed	2740 W
Heater rating	2500 W
Heating drying	1350 W
Motor rating during washing	240 W
Motor rating during spinning	420 W
Water load: normal level	3.5 gals (16 l)
Water load: high level	5.7 gals (26 l)
Maximum water pressure	110 p.s.i. - 759 kN/m ²
Minimum water pressure	7 p.s.i. - 48 kN/m ²
Supply voltage	220 ÷ 240 V
Supply frequency	50 Hz

Installation

Unpacking

After removing outer carton, reinforcing angles and polythene wrapping, proceed as follows:

undo the two winged screws A and B on the back of the washing machine (fig. 1);

remove the two rods fastened by the winged screws A and B (fig. 2);

tilt the machine and remove polystyrene base packing;

remove the four cardboard spacers which will have fallen to the bottom of the machine during the preceding operation.

Positioning & Levelling

Move the washer to its permanent operating location and carefully level it by adjusting the feet and locking them in position with the lock nut (fig. 3).

It is recommended to perform this work very accurately to avoid any vibration, noise or shifting of the appliance during operation.

Also make sure that the washing machine does not touch walls, furniture, etc. while working.

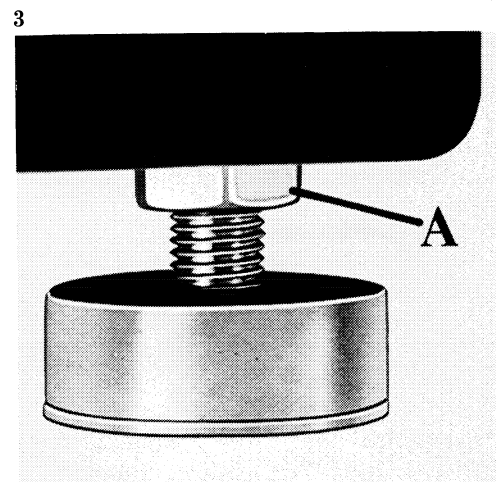
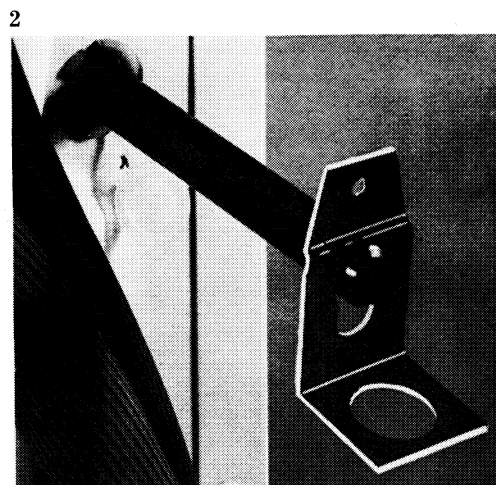
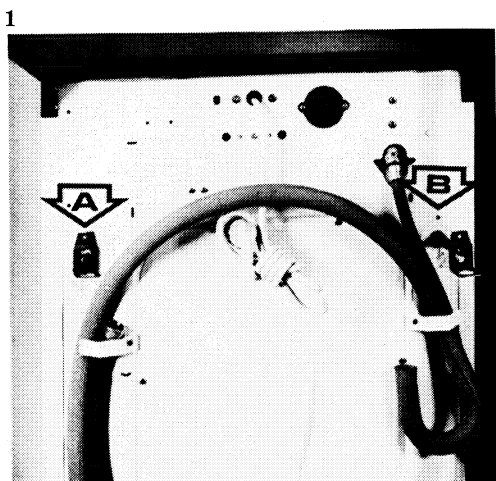

Water connection

Water inlet hose: if a cold water tap having a 3/4" gas thread spout is available, the inlet hose fitted with the rubber sealing washer (supplied with the machine) should be connected as shown (fig. 4).

IMPORTANT: To obtain the best washing results, it is necessary to use the cold water supply only.

If the water connection is made onto new pipes or onto pipes which have not been used for a long time, it is advisable to run off a certain amount of water before connecting the machine. This will avoid foreign matter blocking the filters placed at the end of the water inlet hose.

Water outlet connection

The drain pipe from this machine must connect into the main drain from the premises, but not into the rainwater drain.

Information as to the type of drain servicing your premises can be obtained from a builder or the Local Authority.

The curved end of the outlet hose should be firmly hooked over the edge

of a sink or connected to a suitable drain pipe in the wall or under the sink; however, such a drain pipe should have a built-in air break in order to avoid water syphoning from the machine during draining.

The top of the drain hose (curved end) should not be lower than 50 cms (20 ins) or higher than 85 cms (34 ins) from floor level (fig. 5).

The water should be able to drain freely and the end of the outlet hose must not be under water.

It is, therefore, advisable that the drain pipe, if used, has an internal diameter of at least 4 cms (1,5 ins).

Also, ensure that the drain hose is not choked or placed in such a way as to obstruct the normal water flow.

If the drain hose is to be hooked over the sink, ensure that the sink is empty and that the sink plug is not blocking the plug hole.

If an extension is required, its inner diameter must be the same as that of the original hose of the washer and its length must not exceed 2 metres (6 ft).

Plumbed installation

It is important that work is carried out by a qualified plumber.

4

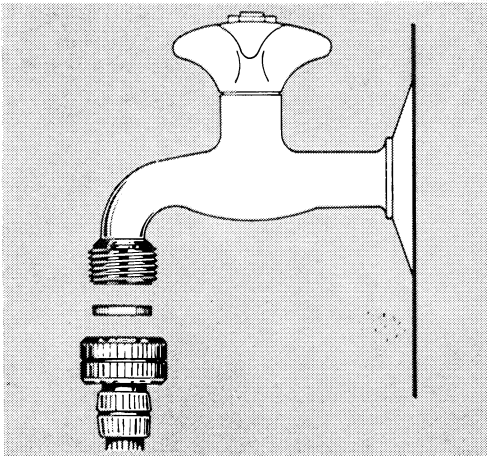

5

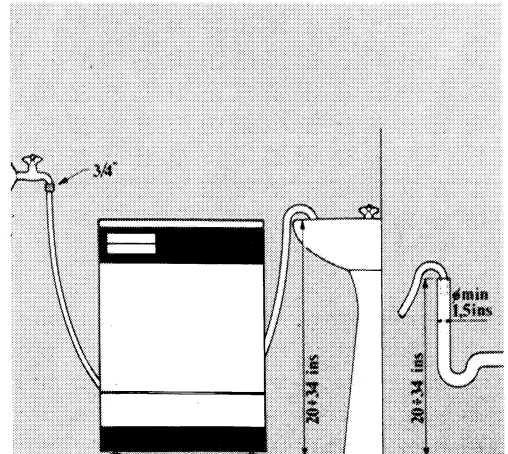

4

Electrical connection

**WARNING:
THIS APPLIANCE
MUST BE EARTHED**

The manufacturer declines to accept any liability should this safety measure not be observed.

Important

The wires in this mains lead are coloured in accordance with the following code:

**GREEN AND YELLOW - EARTH
BLUE - NEUTRAL
BROWN - LIVE**

Your appliance is fitted with a moulded plug and cord. The plug moulded onto the cord incorporates a fuse.

For replacement use a 13 amp BS 1362 fuse. Only ASTA approved fuses should be used. The fuse cover/carrier must be replaced in the event of changing the fuse. The plug must not be used if the fuse cover/carrier is lost. A replacement cover/carrier can be obtained from your local Zanussi Service Agent whose address is listed in the enclosed «Zanussi Service Agents Nationwide» leaflet.

If you fit your own plug, the colours of the wires in the mains lead of your appliance may not correspond with the markings identifying the terminals in your plug; this is what you have to do: Connect the green and yellow (earth) wire to the terminal in the plug which is marked with the letter «E» or the earth symbol \perp or coloured green, or green and yellow.

Connect the blue (neutral) wire to the terminal in the plug which is marked with the letter «N» or coloured black.

Connect the brown (live) wire to the terminal which is marked with the letter «L» or coloured red.

If the plug is not suitable it must be out off and the appropriate plug fitted.

This appliance complies with E.E.C. directive No. 76/889 of 4-11-76 relative to radio interference suppression.

Operating instructions

1. Handle dispenser
2. Drying time control knob
3. Temperature control knob
4. Special features control knob
5. Program selector control knob
6. Drying pilot lamp
7. Mains pilot lamp

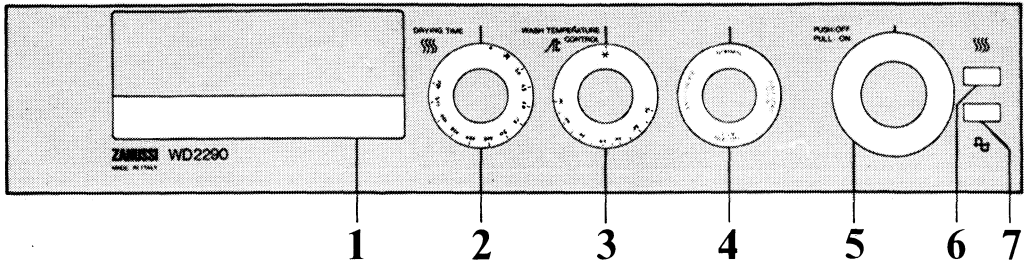

Controls description

1 Handle dispenser

2 Drying Time Control Knob

The drying time can be adjusted with this free-running selector over a wide range of settings, up to a total of 180 minutes.

3 Temperature Control Knob

With the temperature control knob (thermostat) you can select the washing temperatures shown on the powder dispenser.

This control knob is also free-running, so that you may set to any desired temperature, even between the knob graduations.

4 Special Features Control Knob

This control knob has four settings corresponding to the following functions:

4.1 Anti-crease

The Non-Crease Feature, as explained in the covering chapter above, can be selected prior to starting a gentle-action wash program (except program «L» PURE NEW WOOL).

4.2 No-spin

By turning the control knob to this No-Spin setting, the machine will carry out all strong-action wash cycles without any spinning whatsoever, which might prove quite expedient when you wish to wash heavily soiled robust whites in nearly boiling water and without spinning.

4.3 Half-load

Economy Load. This feature is for reduced loads of clothes and saves both electricity and water. Put up to 2 kgs - 4 lbs of normal clothes or 1 kg - 2 lbs of delicate clothes in the machine.

It is suggested that curtains or woollens are not washed on this programme as the low water level is not suitable for the washing of these types of fabrics.

4.4 Normal

This setting cuts out all special-feature programmes described under paragraph 4.1, 4.2 and 4.3 above.

All wash cycles selected with the program control knob (5) are carried out according to the respective strong-action or gentle-action program.

5 Program selector control knob

By turning this program control knob clockwise, you select the required wash cycle.

These wash cycles with the corresponding programmes number are also shown inside the front door of the machine.

To start the washer/dryer, pull out the program control knob. This control knob (timer) inches forward step-by-step during the whole cycle and only stops during the heating phase until the required temperature is reached.

6 Drying pilot lamp

The DRYING pilot lamp lights up whenever the machine performs a drying cycle (see relevant chapter below).

7 Mains pilot lamp

The mains pilot lamp lights up to indicate that the power is on and that the machine is in operation.

6

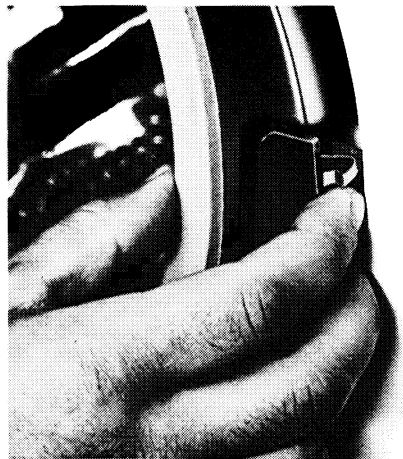

Loading the clothes

Open the front door.

Open the drum loading port by operating the door catch (fig. 6).

Put the clothes into the drum in a uniform manner and close the loading port and the front door.

Filling with washing powder

The washing powder dispenser is located on the front left of the control panel. It is very important to use a low sudsing powder (see paragraph «Which powder») such as Persil Automatic or Bold.

Pull out the dispenser and add washing powder. The amount of washing powder for the prewash should be put into section «a» (fig. 7) of the dispenser and the powder for the main wash should be put into section «b». Once the dispenser is filled, close by pushing in.

Use of additives

The washing machine is designed to carry out special treatments such as the addition of fabric conditioners automatically at the end of some washing programmes.

The conditioner liquids to be used

7

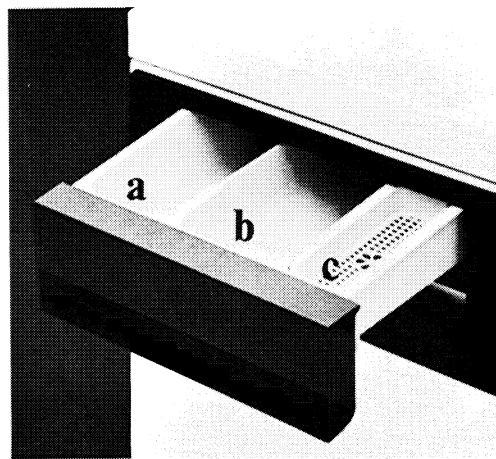

should be put into compartment «C» (fig. 7) of the dispenser at the beginning of the programme. These additives will be automatically used by the machine at the appropriate time. Take care to use the correct amount of additive, following the manufacturer instructions.

Which powder?

Do not use ordinary powders

like Ariel, Radiant, Daz etc. in your new washing machine. The reason for this is very simple, these powders produce so much lather that clothes are prevented from tumbling freely and cannot get properly clean.

Do use the right powder. To get the best results, we recommend Persil Automatic or Bold.

Like all modern automatic machines the WD 2290 works at peak efficiency with a low lather product.

Both these products' balanced lather is specially designed to complement the cleaning action of these machines.

So use it regularly for trouble free washing and superb results.

The amount of powder in grams at full load		
Hardness of water in degrees French (°F)	Prewash	Main wash
Soft: up to 12	25	100
Average: 12 ÷ 25	65	160
Hard: 25 ÷ 37	135	185
Very hard: over 37	175	185

For hardness in ppm multiply indicated hardness value by 10.

For information regarding the degree of hardness in your area, enquire at competent local authority.

For reduced load or light soiling, reduce the quantities accordingly.

Do use enough powder. To get your clothes really clean it is essential that enough powder is used in the machine. The correct amount will depend on a number of things: the hardness of water, the size of the load, and the amount of soiling present. As a guide we suggest you follow the table shown and adjust the amounts in light of your personal experience.

You may find it helps to use a measuring cup at first.

Selection of washing programme

The washing machine carries out 12 washing programmes and 7 additional programmes. Each programme has been specially designed for a specific type of fabric (e.g. cotton, synthetic fibres, wool etc.) and incorporates the H.L.C.C. care labelling scheme.

The appropriate programme must therefore be chosen according to the type of fabric to be washed.

Programme description is to be found on the inside side of the front door.

Starting

After loading the clothes, the washing powder and the fabric conditioners into the respective compartments, make sure — before you start the machine — that:

- the plug is in the wall socket
- the water tap is turned on (fully open)
- the drain hose is correctly placed
- the loading door is correctly closed.

You may now select the required wash cycle by turning the program control knob clockwise after making sure that it is pressed in; select the required water temperature.

Selecte the required special features, if any.

At this point, to start the washing machine simply pull the programme control knob (and the pilot lamp lights up).

Once it is started, the machine will automatically carry out all phases of the selected program.

Stopping

When the program is completed (pilot lamp goes out), the machine stops automatically.

You should now press in the program control knob and wait for about 1÷2 minutes after the wash cycle is completed before you open the door, so as to allow the door safety device (interlock) to release it.

Open the door only after the wash cycle is completed. In the case of the "gentle wash cycles", don't forget to drain the water prior to opening the door.

If need be, you may stop the machine at any given moment during the cycle by pushing in the program control knob. When the wash cycle is completed, it is advisable to unplug the machine from the wall socket and to turn off the water tap.

Drying

If you wish to machine dry your laundry at the end of a wash cycle, leave the tap open and the drain hose hooked over the edge of the sink or in the drain. During the drying cycle, the machine requires approx. 0.5 liters (0.9 pints) of water per minute.

Dampness is removed from the drained laundry by means of a special heating element. This dampness condenses in the machine. However, the small cold water supply causes the resulting steam to condense and the condensate is then drained together with the cooling water and eliminated through the drain hose.

Consequently, you have no need to worry about steamed-up windows and walls, nor is there any need to provide special ventilation of the room in which the machine is set up.

Proceed as follows to carry out a drying cycle:

1) Remove **all** spin-drained laundry from the machine.
2) Sort the laundry to be ironed from the laundry to be only dried and put away.

3) **Important! Load up to a maximum of 2.5 kgs (5.5 lbs) of spin-drained laundry into the drum and be careful to fill it in loose, i.e.: not crammed together.**

In the case of easy-care clothes, load only up to a maximum of 1 kg (2.2 lbs)!

4) Close the loading door.

5) Turn the program control knob to «T» and pull out the control knob.

6) Set drying time control knob as required. The DRYING pilot lamp also lights up, in addition to the mains pilot lamp, and the drying cycle starts.

In the meantime, till the first drying cycle is completed, you might want to hang out the other half of the damp washing on the clothes-line, weather permitting that is.

During the drying cycle, the preset time (duration) may still be shortened or extended, **however under no**

circumstances within the 20-to-0 minutes stretch because during this lapse of time both the machine and the laundry must be allowed to cool off.

If there is a power failure or some other interruption during a drying cycle, you should remove the laundry from the machine without delay.

During the drum standstill there could be a heat «build-up» which would result in undue overheating, particularly of the more delicate laundry

If you wish to interrupt the drying cycle, instead, push in the program control knob and open the loading door.







Fabrics drying times

The drying times of all fabrics and clothes depend on the extent to which they were spin-drained as well as on their distinctive features. Consequently, the times given are to be understood as

Energetic wash cycles

For Cotton, Linen and Hemp Fabrics

Recommended wash load: 10 lbs (4,5 kgs) max.







Wash cycle	Position of program selector and thermostat	Dispenser compartment to be used	Wash cycle description
Whites heavy soil	 A 90°	a b (c)	Prewash in water at 40°C (normal level). Main wash in water at 90°C (normal level). 4 cold water rinses (high level). Spinning.
Whites	 B 90°	b (c)	Main wash in water at 90°C (normal level). 4 cold water rinses (high level). Spinning.
White polycotton	 B 90°	b (c)	Special features position control knob: NO-SPIN. Main wash in water at 90°C (normal level). 4 cold water rinses (high level). Draining without spinning.
Fast coloureds heavy soil	 A 60°	a b (c)	Prewash in water at 40°C (normal level). Main wash in water at 60°C (normal level). 4 cold water rinses (high level). Spinning.
Fast coloureds	 B 60°	b (c)	Main wash in water at 60°C (normal level). 4 cold water rinses (high level). Spinning.
Non fast coloureds heavy soil	 A 40°	a b (c)	Prewash in water at 40°C (normal level). Main wash in water at 40°C (normal level). 4 cold water rinses (high level). Spinning.
Non fast coloureds	 C 40°	b (c)	Main wash in water at 40°C (normal level). 4 cold water rinses (high level). Spinning.
Rinses	D	(c)	4 cold water rinses (high level). Spinning.
Special treatments	E	c	Intake of water mixed with liquid additive (high level). Special treatments. Spinning.
Spin only	F		Spinning for about 5 minutes with simultaneous water draining. This is preceded by slow rotations of the drum.

Gentle wash cycles

For Delicates, Synthetics, Mixed Fabrics and Woollens

Recommended wash load: max. 3-5 lby (1,5-2 Kgs); wool max. 2 lbs (1 Kg).

NOTE: There is no water draining in the last rinse of the gentle wash cycles with the exception of the special wool program, to prevent the clothes from creasing if they are left in the machine at the end of the wash cycles. To drain the water, turn the program selector knob to cycle «P» (draining & gentle spinning) or cycle «R» (draining without spinning).

Wash cycle	Position of program selector and thermostat	Dispenser compartment to be used	Wash cycle description
White nylon heavy soil	 G 60°	a b (c)	Prewash in water at 40°C (high level). Main wash in water at 60°C (high level). 3 cold water rinses (high level).
White nylon	 H 60°	b (c)	Main wash in water at 60°C (high level). 3 cold water rinses (high level).
Delicates	 G 40°	a b (c)	Prewash in water at 40°C (high level). Main wash in water at 40°C (high level). 3 cold water rinses (high level).
Silks	 H 30°	b (c)	Main wash in water at 30°C (high level). 3 cold water rinses (high level).
*Woollens I.W.S. 	 L 30°	b (c)	Short main wash in water at 30°C (high level). 3 cold water rinses (high level). Spinning.
Rinses	M	(c)	3 cold water rinses (high level).
Special treatments	N	c	Intake of water mixed with liquid additive (high level). Special treatments.
Short spin only	P		Water draining followed by a short spin.
Drain	R		Water draining with a steady drum.
Extra prewash	S	a	Prewash in water at 40°C (high level) followed by a soaking phase (the laundry is left soaking in water). To drain the water, turn the program knob to cycle «P» (drain with a gentle spin) or «R» (drain).

Drying	T	See the relevant paragraph. Don't forget to «unfold» the clothes before you start this drying cycle!
---------------	----------	---

* Special cycle for washing wool garments bearing the woolmark label «Pure New Wool washing shrink resistant».

being a general indication only and, as a matter of fact, each housewife will soon work out specific times from her own personal experience.

Here, then is a general indication of these average drying times:

with a drum load of normal laundry (up to 2,5 kgs. = 5.5 lbs): approximately 80 ÷ 100 minutes for ironing dry, and approx. 120 ÷ 140 minutes for ready-to-put-away drying.

With a drum load of easy-care clothes, (up to 1 kg = 2.2 lbs): approximately 40 ÷ 60 minutes for ready-to-put-away drying.

To prevent the formation of wrinkles and creases, all clothes should be removed from the drum without delay after completion of a drying cycle.

Care and cleaning

Cleaning the machine

Important: Make sure that the plug has been removed from the socket prior to undertaking any kind of maintenance.

From time to time, carry out a complete cycle without a washing load, adding 1 oz of «Calgon».

This should also be done when the washer has been out of use for a long time.

Leave the door ajar for about 2 hours after the wash to allow air to circulate freely inside the machine.

Plated, polished and plastic parts and the glass door should be cleaned with a soft damp cloth, never with an abrasive cleaning powder.

For the cabinet exterior use a lukewarm solution of mild soap, then rinse and dry carefully.

It is also advisable to clean the cabinet, from time to time, with a wax polish applied with a soft cloth.

Filter cleaning

The filter (fig. 8) is located on the front of the washer in the bottom right hand corner. Its purpose is to collect fluff and any small objects (safety-pins, coins, etc) inadvertently left in the laundry.

The filter should be cleaned periodically.

If the articles washed are mainly woolen items, then the frequency of filter cleaning should be increased.

At the end of a washing programme place the free end of the drain hose at floor level in a basin to collect any excess water.

Remove the lower panel of the cabinet, by lifting it slightly and pulling it outwards.

Before removing the filter, place a small bowl on the floor below the filter cover to collect any water that may come out.

Unscrew the filter knob anti-clockwise and pull the filter out (fig. 8).

Clean filter and refit, ensuring that the filter knob is screwed tight.

Hints for care of washing powder dispenser

We recommend that the washing powder dispenser is checked regularly to ensure that it is clean and dry.

Do wipe the dispenser after each wash. Should the dispenser require special cleaning, the drawer can be completely removed, and the interior cleared of any deposit.

The drawer can be removed from the front of the appliance by giving a sharp pull outwards. A sharp tap with the palm of the hand may be necessary when replacing the drawer.

Helpfull tips for washing

Here are some practical hints to enable you to obtain the best washing results:

8

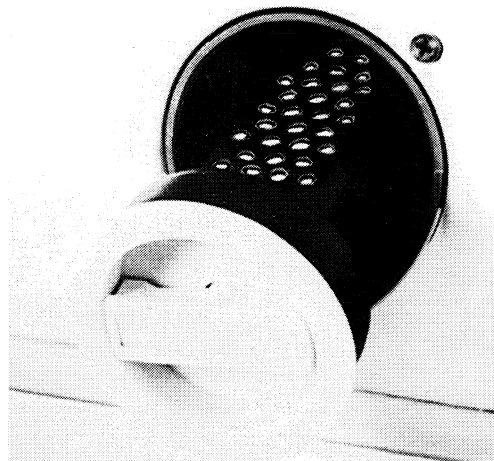

Use a low suds washing powder specially made for front loading washing machines. An excessive formation of suds will cause unsatisfactory operation

The quantity of washing powder required depends on the amount of laundry and on how soiled it is. It may therefore be necessary to vary the quantities suggested in this book according to experience. To obtain the best results when washing wool do not wash more than 2 lbs. at a time.

In order to get good results when washing synthetic material use a maximum washing load of 4 to 5 lbs.

This is a special cycle for washing wool garments bearing the woolmark label «Pure New Wool washing shrink resistant».

If your water is hard it can be softened by adding special products such as «Calgon» to the washing powder in the compartment B (fig. 7). These products facilitate the action of the washing powder and help to give better results.

Clothes should be sorted according to fabric type, degree of soil and colour fastness.

Tears and open seams should be mended, loose buttons secured, zippers closed and laces or belts collected in a cotton bag. Articles without a hem should not be washed. Ensure pockets are emptied and spots of rust, paint, ink etc., removed before washing.

Always turn off water taps fully when the machine is not in use, even if it is plumbed in.

If, after commencing a wash, you find that the wrong programme has been selected, push the control knob fully in turning the indicator knob clockwise to the correct programme. Then pull control knob fully out again.

Washing powder should only be placed in the dispenser immediately prior to the start of a programme. Do not leave washing powder in the dispenser for any length of time as it may form lumps which can be difficult to dissolve.

It is advisable to inspect the filters in the water inlet hoses periodically and clean if necessary.

Servicing

Should servicing be required for this appliance contact your local Service Agent but before requesting service the following simple checks may save you inconvenience and expenses:

● The machine won't start

Check that:

the plug is firmly in the wall socket and that there is an electricity supply by plugging in another appliance; the door of the machine is firmly closed:

the programme control knob is actually pulled out:

make sure the fuses of your electrical installation have not blown.

● The machine won't fill

Check that:

the water tap is turned on and that there is sufficient pressure; the fill hose is not sharply bent.

● The machine fills, but the water empties from the drain hose

Check that:

the end of the drain hose is not placed too low from floor level.

● The machine won't drain or spin

Check that:

the drain hose is not sharply bent (kinked) or placed in such a way as to obstruct a normal water flow; the drain filter is not clogged.

● The machine vibrates or is too noisy

Check that:

the inner packing (transit security) was correctly removed, as described in paragraph «Unpacking»;

the machine is correctly levelled as described in the relevant paragraph the washer is not too close to a wall or to the furniture.

ZANUSSI GUARANTEE CONDITIONS

This guarantee is in addition to your statutory and other legal rights which will not be excluded or in any way diminished by the return of the enclosed card.

We, IAZ International (UK) Ltd, guarantee that if within twelve months of the date of the purchase, this ZANUSSI appliance or any part thereof is proved to be defective by reason only of faulty workmanship or materials we will at our option repair or replace the same **FREE OF ANY CHARGE** for labour, materials or carriage on condition that:

- The appliance has been correctly installed and used only on the electricity supply stated on rating plate.
- The appliance has been used for normal domestic purposes and in accordance with the manufacturer's operating and maintenance instructions.
- The appliance has not been serviced, maintained, repaired, taken apart or tampered with by any person not authorised by us.

- The appliance is still in the possession of the original purchaser.
- Any appliance or defective part replaced shall become our property.

This guarantee does not cover any damage caused during transportation or the replacement of any light bulbs or removable parts of glass or plastic.

Should you require service on your Zanussi appliance consult the enclosed list of service agents for your nearest Zanussi engineer. If the product is under guarantee then you will be required to produce proof of date of purchase to the engineer.

Please ensure that the enclosed pre-addressed card is stamped, completed in full and forwarded to IAZ International (UK) Ltd, to enable the guarantee to be recorded. Also complete the space below as your own record of the guarantee.

GUARANTEE RECORD

Appliance purchased from _____ on _____
Guarantee card no _____ Model no _____
Serial no _____ (These details may be taken from your Guarantee Record Card)
Your name _____
Address _____

Free Manuals Download Website

<http://myh66.com>

<http://usermanuals.us>

<http://www.somanuals.com>

<http://www.4manuals.cc>

<http://www.manual-lib.com>

<http://www.404manual.com>

<http://www.luxmanual.com>

<http://aubethermostatmanual.com>

Golf course search by state

<http://golfingnear.com>

Email search by domain

<http://emailbydomain.com>

Auto manuals search

<http://auto.somanuals.com>

TV manuals search

<http://tv.somanuals.com>