

# ZANUSSI

## WASHER-DRYER WJS 1382

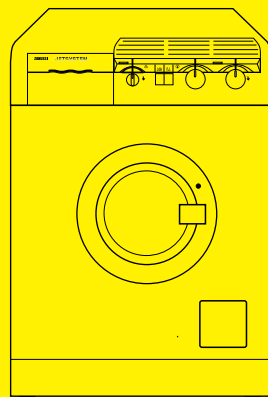

# YOUR NEW WASHER-DRYER

This new machine, which is fitted with the Jet System, patented Zanussi, meets all modern needs for effective treatment of laundry with low water, energy and detergent consumption.

Further savings are achieved by washing small loads of laundry, since water and electricity consumption is proportional to the quantity and type of laundry being washed.

- **The temperature selector dial** will allow you to choose the most suitable temperature for your laundry.
- **The special wool programme** with its new delicate wash system treats your woollen with extreme gentleness.
- The **automatic cooling of the washing water** from 95° to 60°C before draining will prevent old drain pipes from being deformed.
- **The two drying programmes** will give your wash that soft, relaxed feel whatever the weather.

## Hints on how to save energy

By following these hints you will obtain economical washing without damaging the environment:

- Whenever possible, wash the maximum load for the selected programme, without overloading the drum.
- Use the prewash programme only for very soiled laundry.
- Measure out detergent according to the

water hardness, the degree of soiling and the quantity of laundry being washed.

## Environment protection

### ■ Packaging recycling

Materials marked with the  symbol are recyclable. To enable them to be recycled, they must be placed in the appropriate collection areas (or containers). Check with your local authorities.

>PE<= polyethylene

>PS<= polystyrene

>PP<= polypropylene

### ■ Machine scrapping

When the appliance is to be scrapped, cut off the power supply cable and make the door closing device inoperative to avoid it becoming a death trap for a child.

For correct disposal of the machine, contact your local authority department which provides for collection of urban solid refuse.

*The symbols you will see on some paragraphs of this booklet have the following meaning:*



Important information concerning the safety in the use of your machine. Disregarding this information might lead to damages.



Information for correct use of your machine and to obtain the best performance.



Important information concerning environment protection.

***Our contribution to the protection of the environment: we use recycled paper.***

# CONTENTS

<b>Warnings</b>	4	<b>Maintenance</b>	18
<b>Description of the appliance</b>	5	■ Bodywork	18
■ Detergent dispenser drawer	5	■ Detergent dispenser drawer	18
<b>Technical specifications</b>	5	■ Drain filter	18
<b>Installation</b>	6	■ Water inlet filter	19
■ Transit devices	6	■ Emergency emptying out	19
■ Positioning	6	■ Frost precautions	19
■ Water inlet	7	<b>Something not working?</b>	20-21
■ Water drainage	7		
■ Electrical connection	8		
<b>Use</b>	9		
■ Control panel	9		
■ Controls	9		
■ Programme selection	10		
■ Washing and drying hints	11		
Sorting the laundry	11		
Temperatures	11		
Before loading the laundry	11		
Maximum loads	11		
Removing stains	11		
Detergents and additives	12		
Drying	12		
■ International wash code symbols	13		
■ Operating sequence	14-15		
■ Washing and drying programmes	16-17		



# WARNINGS

*It is important that this instruction book be kept with the appliance for future reference. If you sell or give the appliance away, make sure that the book is passed to the new owners so that they can familiarise themselves with its operation and relevant warnings.*

*The following warnings are provided in the interests of overall safety. You must read them carefully before installing or using the appliance.*

## General warnings

- When unpacking the appliance, check that it is not damaged. If in doubt, do not use it and contact the Service Centre.
- This appliance is designed to be used by adults. Children must not be allowed to touch the controls or play with the product.
- During high temperature washing and drying cycles the glass door becomes very hot. Do not touch it.
- Pets sometimes climb into washing machines. Check the drum before each use.

## Installation

- All internal packing must be removed before using the appliance. Serious damage may be caused to the machine or adjacent furniture if the protective transit devices are not removed or are not completely removed. Refer to the relevant paragraph in the instruction book.
- Any electrical work required to install this appliance must be carried out by a qualified electrician.
- Any plumbing work required to install this appliance must be carried out by a qualified plumber.
- After having installed the machine, check that it is not standing on its electrical supply cable.
- If the appliance is placed on a carpeted floor, ensure that air can circulate freely between the adjustable feet and the floor.

## Use

- This appliance is designed for domestic use. It must not be used for purposes other than those for which it was designed.
- Only wash and dry fabrics which are designed to be machine washed and dried. Follow the instructions on each garment label.
- If you use a liquid detergent with a dispenser which has to be placed directly in the drum, remember to remove this dispenser before drying.

- Do not overload the appliance. Follow the instructions in the instruction book.
- Make sure that all pockets are empty. Objects such as coins, safety pins, pins and screws can cause extensive damage.
- Do not machine wash garments saturated with petroleum, methylated spirits, trichlorethylene, etc. If such fluids have been used to remove stains prior to washing, wait until they have completely evaporated from the fabric before placing garments in the appliance.
- Place small items such as socks, belts, etc. in a cloth bag or pillowcase to prevent them getting trapped between the drum and the tub.
- Use only the recommended quantities of fabric softener. An excessive amount could damage the laundry.
- Leave the porthole door slightly ajar when the appliance is not in use. This preserves the door seal and prevents the formation of musty smells.
- Always check that water has emptied out before opening the door. If not, drain the water following the instructions in the instruction book.
- Always unplug the appliance and shut the water tap after use.

## Service/repair

- In the event of a fault, do not attempt to repair the appliance yourself. Repairs carried out by inexperienced persons may cause damage.
- If repairs are needed, contact an authorised service centre and ask for genuine spare parts.

# DESCRIPTION OF THE APPLIANCE

- 1 Detergent dispenser drawer
- 2 Drying pilot light
- 3 Drying time selector dial
- 4 Spin speed reduction button
- 5 On/Off button
- 6 Temperature selector dial
- 7 Operating pilot light
- 8 Programme selector dial
- 9 Programme card
- 10 Door locked light
- 11 Door handle
- 12 Filter
- 13 Adjustable feet

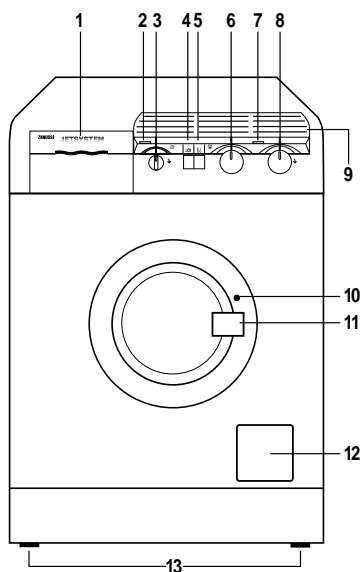

## Detergent dispenser drawer

- Prewash
- Main wash
- Fabric softener

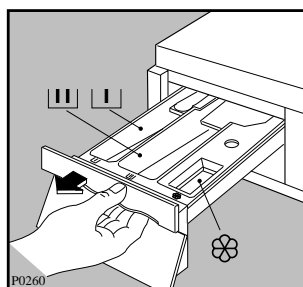

# TECHNICAL SPECIFICATIONS

DIMENSIONS	Height	85 cm	
	Width	60 cm	
	Depth	60 cm	
MAXIMUM LOAD		<b>WASHING</b>	<b>DRYING</b>
	Cotton	6.5 kg	3 kg
	Synthetics	2.5 kg	2 kg
	Delicates	2 kg	-
	Woollens	1 kg	-
SPIN SPEED		1300 rpm max.	
POWER SUPPLY VOLTAGE/FREQUENCY		220-230 V/50 Hz	
TOTAL POWER ABSORBED		2200 W	
MINIMUM FUSE PROTECTION		10 A	
WATER PRESSURE	Minimum	5 N/cm <sup>2</sup>	
	Maximum	80 N/cm <sup>2</sup>	

**CE** This appliance complies with the following EEC Directives:  
 73/23/EEC of 19/02/73 relating to low voltage  
 89/336/EEC of 03/05/89 relating to electromagnetic compatibility

# INSTALLATION

## Unpacking



All transit bolts and packing must be removed before using the appliance.

You are advised to keep all transit devices so that they can be refitted if the machine ever has to be transported again.

1. Using a spanner, unscrew and remove the rear right-hand bolt and lay the machine on its back, taking care not to squash the hoses. This can be avoided by placing one of the corner packing pieces between the machine and the floor.
2. Remove the polystyrene block from the bottom of the machine and release the two plastic bags by removing the adhesive strip.
3. Carefully remove the right-hand bag (1) then the left-hand bag (2) by pulling them towards the centre of the machine.
4. Set the machine upright and remove the two remaining bolts from the back.
5. Pull out the three plastic spacers from the holes into which the bolts were fitted.
6. Plug the open holes with the plugs which you will find in the plastic bag containing the instruction booklet.

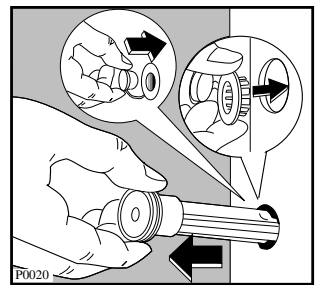
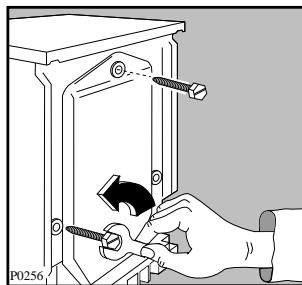
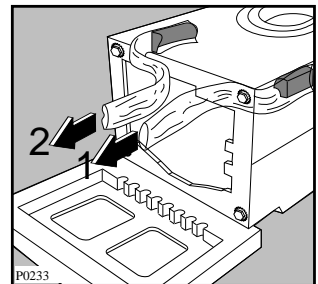
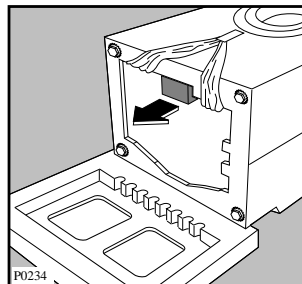
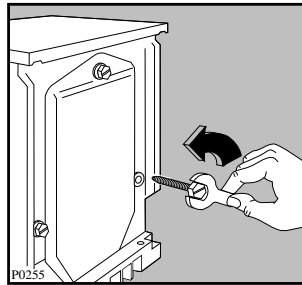

## Positioning

Install the machine on a flat hard floor. Make sure that air circulation around the machine is not impeded by carpets, rugs etc. Check that the machine does not touch the wall or other kitchen units. Carefully level by screwing the adjustable feet in or out. Never place cardboard, wood or similar materials under the machine to compensate for any unevenness in the floor. After having levelled the machine, tighten the lock nuts.

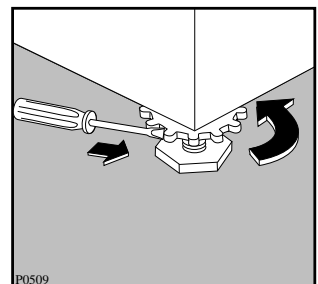
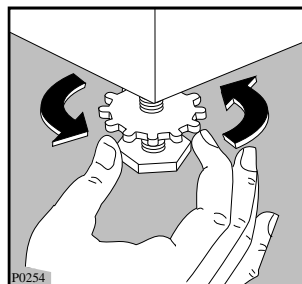

## Water inlet

Connect the water inlet hose to a tap with a 3/4" thread after having inserted the small filter "A" supplied with the machine.

The other end of the inlet hose which connects to the machine can be turned in any direction. Simply loosen the fitting, rotate the hose and retighten the fitting, making sure there are no water leaks.

The inlet hose must not be lengthened. If it is too short and you do not wish to move the tap, you will have to purchase a new, longer hose specially designed for this type of use.

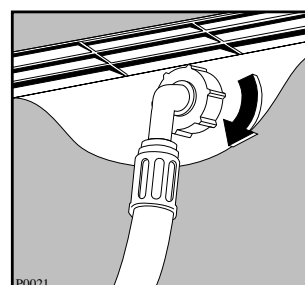
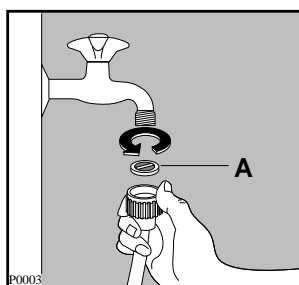

## Water drainage

The end of the drain hose can be positioned in three ways:

**Hooked over the edge of a sink using the plastic hose guide supplied with the machine.**

In this case, make sure the end cannot come unhooked when the machine is emptying. This could be done by tying it to the tap with a piece of string or attaching it to the wall.

**In a sink drain pipe branch.** This branch must be above the trap so that the bend is at least 60 cm above the ground.

**Directly into a drain pipe at a height** of not less than 60 cm and not more than 90 cm.

The end of the drain hose must always be **ventilated**, i.e. the inside diameter of the drain pipe must be larger than the outside diameter of the drain hose.

The drain hose must not be kinked. Run it along the floor; only the part near the drainage point must be raised.

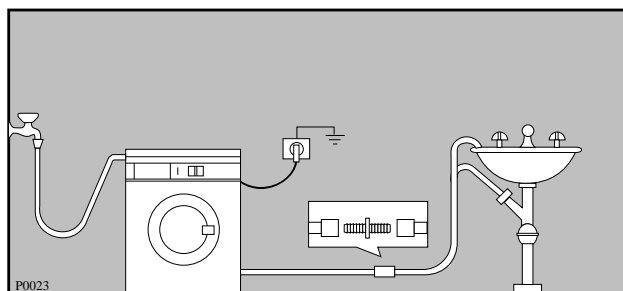
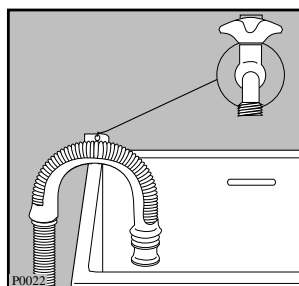

## Electrical connection

This machine is designed to operate on a 220-230 V, single-phase, 50 Hz supply.

Check that your domestic electrical installation can take the maximum load required (2.2 kW), also taking into account any other appliances in use.

---

**WARNING: THIS APPLIANCE MUST BE EARTHED.**



**The manufacturer declines any liability should this safety measure not be observed.**

---

The appliance is supplied with a 13 amp plug fitted.

In the event of having to change the fuse in the plug supplied, a 13amp ASTA approved (BS1362) fuse must be used.

Should the plug need to be replaced for any reason, proceed as described below.

The wires in the mains lead are coloured in accordance with the following code:

Green and Yellow	- Earth
Blue	- Neutral
Brown	- Live

The wire coloured green and yellow must be connected to the terminal marked with the letter «E» or by the earth symbol  $\perp$  or coloured green and yellow.

The wire coloured blue must be connected to the terminal «N» or coloured black.

The wire coloured brown must be connected to the terminal marked «L» or coloured red.

Upon completion there must be no cut, or stray strands of wire present and the cord clamp must be secure over the outer sheath.

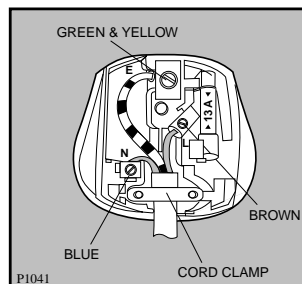

---

**WARNING:**



**A cut off plug inserted into a 13 amp socket is a serious safety (shock) hazard.**

**Ensure that the cut off plug is disposed of safely.**

---



# USE

## Control panel

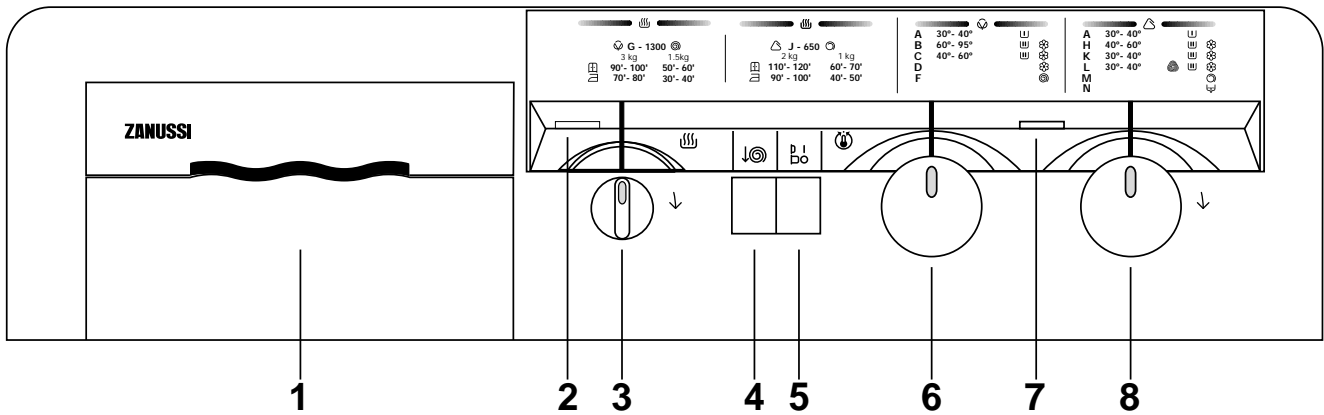

### 1 Detergent dispenser drawer

### 2 Drying pilot light

It illuminates when drying starts.

### 3 Drying time selector dial

Graduated up to 120 minutes for cotton and synthetics, allows drying time to be selected according to the type and amount of laundry and the required degree of dryness:

- **blue sector** for cotton
- **green sector** for synthetics

Turn the dial **clockwise** only.

### Cooling phase

To allow the laundry to cool down, a cooling phase starts automatically 10 minutes before the end of drying and this phase must in no circumstances be reduced or interrupted.

### 4 Spin speed reduction button

By depressing this button the spin speed is reduced as follows:

- **cotton, linen:** from 1300 to 650 rpm
- **programme M** (short spin) **and A** (extra prewash): from 650 to 450 rpm.

We suggest you not to press this button, when you have to machine dry laundry in order to save energy and time.

### 5 On/Off button

Press this button to start the machine, press again to interrupt a programme or switch off the power supply to the machine.

### 6 Temperature selector dial

Turn this dial clockwise or anti-clockwise to select the required temperature.

Position  $\times$  means that the machine will wash with cold water.

Press the dial to pop it out.

### 7 Operating pilot light

This light is on whilst the machine is operating and goes out when the ON/OFF button is pressed again.

### 8 Programme selector dial

To select the required programme, turn this dial **clockwise** until the programme letter is exactly opposite the pointer.

Press the dial to pop it out.

## Programme selection

### ■ Washing only

Load size:

- cotton, linen max 6.5 kg
- synthetics, delicate fabrics 2.5 kg
- woollens 1 kg
- Place the detergent and additive in the dispenser drawer.
- Select the temperature and the wash programme.
- Press button ↓Ⓢ if required.
- Press the ON/OFF button  $\frac{P}{\text{ON}}$ .

### ■ Drying only

Load size:

- cotton, linen max 3 kg
- synthetics 2 kg
- Select the drying time in the relevant sector.
- Select the drying programme **G** or **J**.
- Press the ON/OFF button  $\frac{P}{\text{ON}}$ .

### ■ Automatic washing and drying (NON-STOP programme)

**Automatic** washing and drying is only possible with **linen, cotton** and **synthetics** programmes.

The maximum load size is 3 kg **for cotton** and 2 kg **for synthetics**.

**Do not exceed these quantities.**

- Select the temperature and the wash programme.
- Select the drying time in the relevant sector.
- Press the ON/OFF button  $\frac{P}{\text{ON}}$ .

The laundry will be washed and dried without any further action by you.

## **i** Washing and drying hints

### Sorting the laundry

Follow the wash code symbols on each garment label and the manufacturer's washing instructions. Sort the laundry as follows:  
whites, coloureds, synthetics, delicates, woollens.

### Temperatures

- 95°** for normally soiled white cottons and linen (e.g. tea cloths, towels, tablecloths, sheets...)
- 60°** for normally soiled, colour fast garments (e.g. shirts, night dresses, pyjamas...) in linen, cotton or synthetic fibres and for lightly soiled white cotton (e.g. underwear).
- \* (cold) 30°-40°** for delicate items (e.g. net curtains), mixed laundry including synthetic fibres and woollens bearing the label «pure new wool, machine washable, non-shrink».

### Before loading the laundry

Never wash whites and coloureds together. Whites may lose their "whiteness" in the wash. New coloured items may run in the first wash; they should therefore be washed separately the first time.

**Make sure that no metal objects are left in the laundry (e.g. hair clips, safety pins, pins).**

Button up pillowcases, close zip fasteners, hooks and poppers. Tie any belts or long tapes.

Remove persistent stains before washing. Rub particularly soiled areas with a special detergent or detergent paste.

Treat curtains with special care. Remove hooks or tie them up in a bag or net.

### Maximum loads

Recommended loads are indicated in the programme charts.

General rules:

**Cotton, linen:** drum full but not too tightly packed;

**Synthetics:** drum no more than half full;

**Delicate fabrics and woollens:** drum no more than one third full.

Washing a maximum load makes the most efficient use of water and energy.

For heavily soiled laundry, reduce the load size.

### Laundry weights

The following weights are indicative:

bathrobe	1200 g
napkin	100 g
quilt cover	700 g
sheet	500 g
pillow case	200 g
tablecloth	250 g
towelling towel	200 g
tea cloth	100 g
night dress	200 g
ladies' briefs	100 g
man's work shirt	600 g
man's shirt	200 g
man's pyjamas	500 g
blouse	100 g
men's underpants	100 g

### Removing stains

Stubborn stains may not be removed by just water and detergent. It is therefore advisable to treat them prior to washing.

**Blood:** treat fresh stains with cold water. For dried stains, soak overnight in water with a special detergent then rub in the soap and water.

**Oil based paint:** moisten with benzine stain remover, lay the garment on a soft cloth and dab the stain; treat several times.

**Dried grease stains:** moisten with turpentine, lay the garment on a soft surface and dab the stain with the fingertips and a cotton cloth.

**Rust:** oxalic acid dissolved in hot water or a rust removing product used cold. Be careful with rust stains which are not recent since the cellulose structure will already have been damaged and the fabric tends to hole.

**Mould stains:** treat with bleach, rinse well (whites and fast coloureds only).

**Grass:** soap lightly and treat with bleach (whites and fast coloureds only).

**Ball point pen and glue:** moisten with acetone (\*), lay the garment on a soft cloth and dab the stain.

**Lipstick:** moisten with acetone as above, then treat stains with methylated spirits. Remove any residual marks from white fabrics with bleach.

**Red wine:** soak in water and detergent, rinse and treat with acetic or citric acid, then rinse. Treat any residual marks with bleach.

**Ink:** depending on the type of ink, moisten the fabric first with acetone (\*), then with acetic acid; treat any residual marks on white fabrics with bleach and then rinse thoroughly.

**Tar stains:** first treat with stain remover, methylated spirits or benzine, then rub with detergent paste.

**(\*) do not use acetone on artificial silk**

## Detergents and additives

Good washing results also depend on the choice of detergent and use of the correct quantities to avoid waste and protect the environment. Although biodegradable, detergents contain substances which, in large quantities, can upset the delicate balance of nature.

The choice of detergent will depend on the type of fabric (delicates, woollens, cottons, etc.), the colour, washing temperature and degree of soiling.

All commonly available washing machine detergents may be used in this appliance:

- powder detergents for all types of fabric,
- powder detergents for delicate fabrics (60°C max) and woollens,
- liquid detergents, preferably for low temperature wash programmes (60°C max) for all types of fabric, or special for woollens only.

The detergent and any additives must be placed in the appropriate compartments of the dispenser drawer before starting the wash programme.

If using concentrated powder or liquid detergents, a programme **without** prewash must be selected.

The washing machine incorporates a recirculation system which allows an optimal use of the concentrated detergent.

Pour liquid detergent into the dispenser drawer compartment marked  **just before** starting the programme.

Any fabric softener or starching additives must be poured into the compartment marked  before starting the wash programme.

Follow the product manufacturer's recommendations on quantities to use and **do not exceed the «MAX» mark in the detergent dispenser drawer.**

## Quantity of detergent to be used

The type and quantity of detergent will depend on the type of fabric, load size, degree of soiling and hardness of the water used.

Water hardness is classified in so-called "degrees" of hardness. Information on hardness of the water in your area can be obtained from the relevant water supply company, or from your local authority.

Follow the product manufacturers' instructions on quantities to use.

Use less detergent if:

- you are washing a small load
- the laundry is lightly soiled
- large amounts of foam form during washing.

## Degrees of water hardness

Level	Characteristic	Degrees	
		German °dH	French °T.H.
1	soft	0- 7	0-15
2	medium	8-14	16-25
3	hard	15-21	26-37
4	very hard	more than 21	more than 37













## Drying



- All laundry to be dried must be thoroughly spun. The higher the spin speed, the lower the power consumption and the shorter the drying time.
- Scrupulously follow the instructions on each garment label, making sure that it is suitable for tumble-drying.
- Do not tumble dry the following:
  - wool, silk, synthetic curtains;
  - articles with a plasticised finish, nylon tights or stockings, sleeping bags, quilts, articles made of foam rubber or containing materials similar to foam rubber, fabrics with metal inserts;
  - fabrics which tend to fray.





**Important:** during the drying cycle, the water tap must be left open and the drain hose must be correctly positioned.





## **i** International wash code symbols







These symbols appear on fabric labels, in order to help you choose the best way to treat your laundry.

<b>Energetic wash</b>  	 Max. wash temperature 95°C	 Max. wash temperature 60°C	 Max. wash temperature 40°C	 Max. wash temperature 30°C	 Hand wash	 Do not wash at all
	<b>Delicate wash</b>	  				

 <b>Bleaching</b>	 Bleach in cold water	 Do not bleach
---	---	--

 <b>Ironing</b>	 Hot iron max 200°C	 Warm iron max 150°C	 Lukewarm iron max 110°C	 Do not iron
---	---	--	--	--

 <b>Dry cleaning</b>	 Dry cleaning in all solvents	 Dry cleaning in perchlorethylene, petrol, pure alcohol, R 111 & R 113	 Dry cleaning in petrol, pure alcohol and R 113	 Do not dry clean
--	---	--	---	---

 <b>Drying</b>	 Flat	 On the line	 On clothes hanger	 high temperature  low temperature Tumble dry	 Do not tumble dry
--	---	--	--	---	--

## **i** Operating sequence

### **Automatic washing and drying (non-stop programme)**

This option is only possible for cottons and synthetics.

Maximum load:

- cotton, linen 3 kg
- synthetics 2 kg

*Before washing your first load of laundry, we recommend that you run a cotton cycle at 60°C, with the machine empty, in order to remove any manufacturing residue from the drum and tub. Pour half a measure of detergent into the main wash compartment and start up the machine.*

#### **1. Place the laundry in the drum**

Open the door.

Place the laundry in the drum, one item at a time, shaking them out as much as possible.

Close the door.

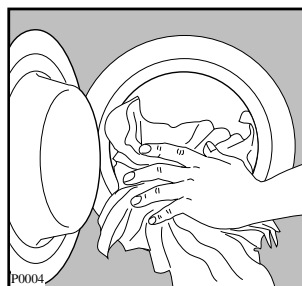

#### **2. Measure out the detergent**

Pull out the dispenser drawer until it stops. Measure out the amount of detergent recommended by the manufacturer in a graduated cup and pour it into the main wash compartment .

If you wish to carry out the extra prewash, pour detergent into the appropriate compartment marked .

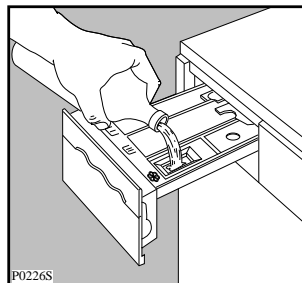

#### **3. Measure out the additive**

If required, pour fabric softener into the compartment marked  **without exceeding the «MAX» mark.**

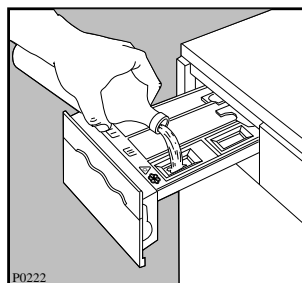

#### **4. Select the temperature**

Turn the dial to the required setting.

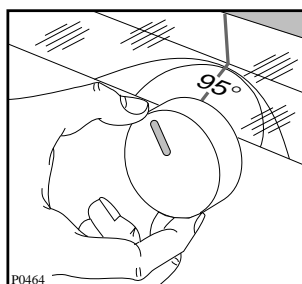

## 5. Select the drying time

Turn the selector dial clockwise to the required time setting (blue or green sector).

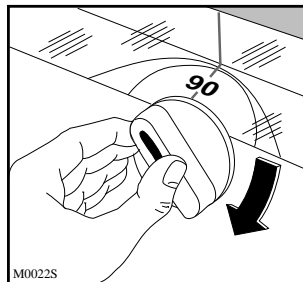

## 6. Select the programme and start the machine

Turn the programme selector dial clockwise to the required programme and press the On/Off button: the operating pilot light and door locked light come on and the machine starts to operate.

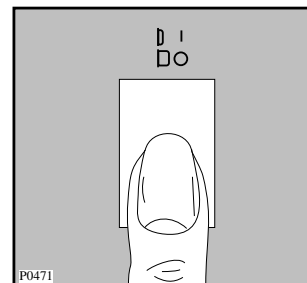
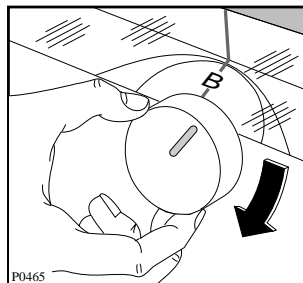

## 7. At the end of the programme

The machine stops automatically.

Wait one or two minutes before opening the door to give the electric locking mechanism time to release it.

The door can be opened when the door locked pilot light is off.

Depress the On/Off button again to switch the machine off. The operating pilot light goes out.

Remove the laundry.

Turn the drum by hand to make sure it is completely empty, so as to avoid any forgotten items being damaged in a subsequent wash (e.g. shrinking) or their colour running into a load of whites.

Release any buttons which have been pressed.





Turn the water tap off and unplug the machine.

Leave the door ajar to air the machine.

## Energetic programmes for cotton and linen



Maximum load: washing 6.5 kg  
washing+drying 3 kg

### Washing

Progr.	Temp.	Type of laundry	Cycle description	Possible option
<b>B</b>	<b>60°-95°</b>	Whites, normally soiled	Wash at 60°-95°C 3 rinses Long spin	↓ 
<b>C</b>	<b>40°-60°</b>	Coloureds, normally soiled	Wash at 40°-60°C 3 rinses Long spin	↓ 
<b>D</b>		Rinses	3 rinses with additive Long spin	↓ 
<b>F</b>		Spin	Drain and long spin	↓ 
<b>A</b>	<b>30°-40°</b>	Extra prewash	Prewash at 30°-40°C Short spin	↓ 

The temperatures indicated are the optimum temperatures for each programme and depend on the type of laundry and degree of soiling.

**Drying:** maximum load 3 kg  
Drying time selector 0-120 min, **blue sector**.

Programme	Type of laundry	Degree of drying	Quantity	Time mins.
<b>G</b>	Cotton and linen spun at 1300 rpm	Store dry 	3 kg 1.5 kg	90-100 50-60
		Iron dry 	3 kg 1.5 kg	70-80 30-40





## Delicate programmes for synthetics, mixed fibres, delicates and woollens

**Maximum load:** washing 2.5 kg (woollens 1 kg)  
washing+drying (synthetics) 2 kg

At the end of these programmes, the last rinse water is not emptied out, so as to avoid creasing of the fabrics. To empty out the water, select programme **M** or **N**.



**Important:** When the automatic NON-STOP washing plus drying programme is used, the water is emptied out automatically and there is a short spin before drying starts.

### Washing

Progr.	Temp.	Type of laundry	Cycle description	Possible option
<b>H</b>	40°-60°	Synthetics, normally soiled	Wash at 40°-60°C 3 rinses Stop with water in drum	
<b>K</b>	30°-40°	Delicate fabrics, silk	Wash at 30°-40°C 3 rinses Stop with water in drum	
<b>L</b>	30°-40°	Woollens 	Wash at 30°-40°C 3 rinses Stop with water in drum	
<b>M</b>		Short spin	Drain and short spin	
<b>N</b>		Drain	Empty out water	
<b>A</b>	30°-40°	Extra prewash (not for wool)	Prewash at 30°-40°C Short spin	

The temperatures indicated are the optimum temperatures for each programme and depend on the type of laundry and degree of soiling.

**Drying:** maximum load 2 kg  
Drying time selector 0-120 min, **green sector**.

Programme	Type of laundry	Degree of drying	Quantity	Time mins.
<b>J</b>	Synthetics, spun at 650 rpm	Store dry 	2 kg 1 kg	110-120 60-70
		Iron dry 	2 kg 1 kg	90-100 40-50

# MAINTENANCE

## 1. Bodywork

Clean the outside of the machine with warm water and a neutral, non-abrasive household detergent. Rinse with clean water and dry with a soft cloth.

**Important:** do not use methylated spirits, solvents or similar products to clean the bodywork.

## 2. Detergent dispenser drawer

After a while, detergents and fabric softeners leave deposits in the drawer.

Clean the drawer from time to time by rinsing it under a running tap. To remove the drawer from the machine, press the button in the rear left-hand corner.

To facilitate cleaning, the top part of the additive compartments can be removed.

Detergent can also accumulate inside the drawer recess: clean it with an old toothbrush. Refit the drawer after cleaning.

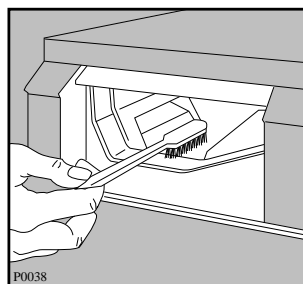
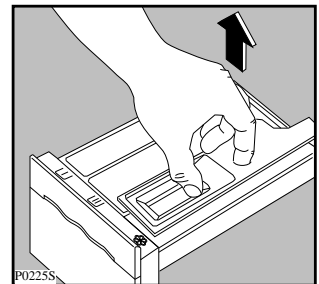
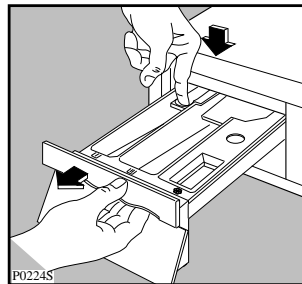

## 3. Drain filter

The drain filter collects threads and small objects inadvertently left in the laundry. Check regularly that the filter is clean.

Open the filter door.

Place a container under the filter and unscrew it.

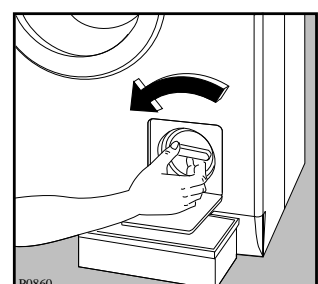
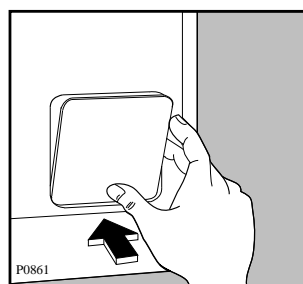

Pull out the filter.

Clean the filter under a running tap, then refit it, screwing it fully in.

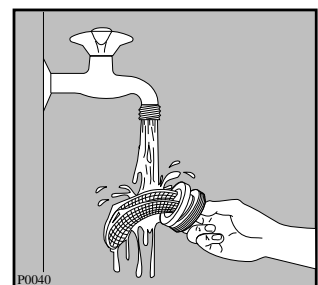
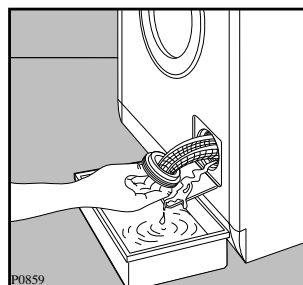

## 4. Water inlet filter

If you notice that the machine is taking longer to fill, check that the filter in the water inlet hose is not blocked.

Turn off the water tap.

Unscrew the hose from the tap and remove the filter.

Clean it with a stiff brush.

Refit the filter and screw the hose back onto the tap.

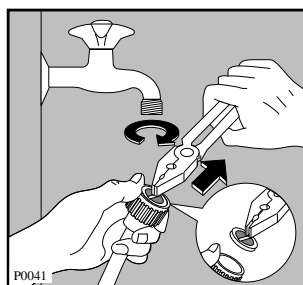

## 5. Emergency emptying out

If the water is not discharged (outlet pump is blocked, filter or outlet hose are clogged), proceed as follows to empty out the machine:

- pull out the plug from the power socket;
- close the water tap;
- if necessary, wait until the water has cooled down;
- place a bowl on the floor;
- put the outlet hose end into the bowl and let the water come out.

Should it not be possible to have access to the outlet hose because, for example, the appliance is built in the kitchen furniture, slightly loosen the outlet filter after placing a bowl on the floor, to let the water come out slowly.

At the end screw the filter again.

## 6. Frost precautions

If the machine is installed in a place where the temperature could drop below 0°C, proceed as follows:

- Close the water tap and unscrew the water inlet hose from the tap.
- Place the end of the outlet hose and that of the inlet hose in a bowl placed on the floor.
- Select programme **N** (drain) and run it until the machine stops.
- Remove the plug from the socket.
- Screw the water inlet hose back on and put the outlet hose back in its place.

By doing this, any water remaining in the machine is removed, avoiding the formation of ice and, consequently, breakage of the affected parts.

When you use the machine again, make sure that the ambient temperature is above 0°C.

## SOMETHING NOT WORKING?

*Problems which you can resolve yourself*

<b>Problem</b>	<b>Possible cause</b>
<ul style="list-style-type: none"> <li>■ <b>The machine does not start up:</b></li> </ul>	<ul style="list-style-type: none"> <li>■ Check that the door is firmly closed.</li> <li>■ Check that the machine is plugged in and that there is power at the socket.</li> <li>■ Check that the main fuse and the fuse in the plug has not blown.</li> <li>■ Check that the programme selector dial is positioned correctly and the ON/OFF button depressed.</li> </ul>
<ul style="list-style-type: none"> <li>■ <b>The machine does not fill:</b></li> </ul>	<ul style="list-style-type: none"> <li>■ Check that the water tap is open.</li> <li>■ Check that water is coming out of the tap.</li> <li>■ Check that the inlet hose is not squashed or kinked.</li> <li>■ Check that the filter in the inlet hose is not blocked.</li> <li>■ Check that the door is closed.</li> </ul>
<ul style="list-style-type: none"> <li>■ <b>The machine does not empty and/or does not spin:</b></li> </ul>	<ul style="list-style-type: none"> <li>■ Check that the drain hose is not squashed or kinked.</li> <li>■ A programme which stops with water in drum has been selected.</li> <li>■ Check that the laundry is evenly distributed in the drum.</li> </ul>
<ul style="list-style-type: none"> <li>■ <b>There is water on the floor:</b></li> </ul>	<ul style="list-style-type: none"> <li>■ Too much detergent or unsuitable detergent (creates too much foam) has been used.</li> <li>■ Check whether there are any leaks from one of the inlet hose fittings. It is not always easy to see this as the water runs down the hose; check to see if it is damp.</li> <li>■ Check that the drain hose is not damaged.</li> </ul>
<ul style="list-style-type: none"> <li>■ <b>Unsatisfactory washing results:</b></li> </ul>	<ul style="list-style-type: none"> <li>■ Too little detergent or unsuitable detergent has been used.</li> <li>■ Stubborn stains have not been treated prior to washing.</li> <li>■ The correct temperature/programme was not selected.</li> <li>■ Excessive laundry load.</li> </ul>
<ul style="list-style-type: none"> <li>■ <b>The machine vibrates or is noisy:</b></li> </ul>	<ul style="list-style-type: none"> <li>■ Check that all the transit bolts and packing have been removed.</li> <li>■ Check that the machine is not resting against anything.</li> <li>■ Check that the support feet are resting firmly on the ground and that the lock nuts are securely tightened.</li> <li>■ Check that the laundry is evenly distributed in the drum.</li> <li>■ Maybe there is very little laundry in the drum.</li> </ul>

<ul style="list-style-type: none"> <li>■ <b>The machine fills then empties immediately:</b></li> </ul>	<ul style="list-style-type: none"> <li>■ The end of the drain hose is too low. Refer to relevant paragraph in “water drainage” section.</li> </ul>
<ul style="list-style-type: none"> <li>■ <b>The door will not open:</b></li> </ul>	<ul style="list-style-type: none"> <li>■ The programme is still running.</li> <li>■ The door lock has not been released.</li> <li>■ There is water in the drum. The door can be opened when the door locked light is off.</li> </ul>
<ul style="list-style-type: none"> <li>■ <b>Spinning starts late or the machine does not spin:</b></li> </ul>	<ul style="list-style-type: none"> <li>■ The electronic unbalance detection device has cut in because the laundry is not evenly distributed in the drum. The laundry is redistributed by reverse rotation of the drum. This may happen several times before the unbalance disappears and normal spinning can resume. If, after 10 minutes, the laundry is still not evenly distributed in the drum, the machine will not spin. In this case, redistribute the load manually and reselect the spin programme.</li> </ul>
<ul style="list-style-type: none"> <li>■ <b>The machine makes an unusual noise:</b></li> </ul>	<ul style="list-style-type: none"> <li>■ The machine is fitted with a commutator motor which makes an unusual noise compared with other traditional machines. This motor enables a softer start to the spin and controls the increase in spin speed better. In this way, machine performance is improved.</li> </ul>
<ul style="list-style-type: none"> <li>■ <b>Water is not visible in the machine:</b></li> </ul>	<ul style="list-style-type: none"> <li>■ The machine, which is the result of modern technology, runs in a very economical way with low water consumption. Performance is nevertheless excellent.</li> </ul>
<ul style="list-style-type: none"> <li>■ <b>The machine does not dry or the laundry is not dry enough:</b></li> </ul>	<ul style="list-style-type: none"> <li>■ The drying time has not been selected.</li> <li>■ The tap is closed.</li> <li>■ The drain filter is blocked.</li> <li>■ A suitable drying time in the correct sector has not been selected.</li> <li>■ The drum is overloaded.</li> <li>■ You have selected option ↓⊙ before drying.</li> </ul>

If you are unable to identify or solve the problem, contact our service centre. Before telephoning, make a note of the model, serial number and purchase date of your machine: the Service Centre will require this information.

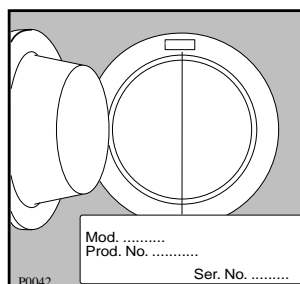



Made in Italy

Z

## Free Manuals Download Website

<http://myh66.com>

<http://usermanuals.us>

<http://www.somanuals.com>

<http://www.4manuals.cc>

<http://www.manual-lib.com>

<http://www.404manual.com>

<http://www.luxmanual.com>

<http://aubethermostatmanual.com>

Golf course search by state

<http://golfingnear.com>

Email search by domain

<http://emailbydomain.com>

Auto manuals search

<http://auto.somanuals.com>

TV manuals search

<http://tv.somanuals.com>