

ZANUSSI

WASHER-DRYER ZJD 12191

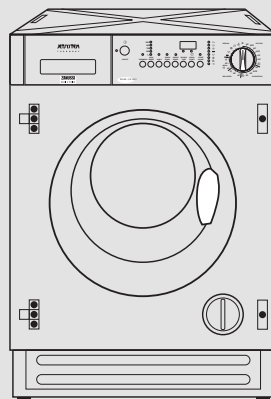

i Quick Installation Guide:

visit our WEB SITE to view an install video

www.video.uk.electrolux.com



Important Safety Information

It is most important that this instruction book should be retained with the appliance for future reference. Should the appliance be sold or transferred to another owner, or should you move house and leave the appliance, always ensure that the book is supplied with the appliance in order that the new owner can get to know the functioning of the appliance and the relevant warnings.

These warnings have been provided in the interest of safety. You **MUST** read them carefully before installing or using the appliance.

Installation

- This appliance is heavy. Care should be taken when moving it.
- It is dangerous to alter the specifications or attempt to modify this product in any way.
- All packing and transit bolts must be removed before use. Serious damage can occur to the product and to property if this is not adhered to. See relevant section in instructions.
- Any plumbing work required to install this appliance should be carried out by a qualified plumber or competent person.
- Any electrical work required to install this appliance should be carried out by a qualified electrician or competent person.
- Care must be taken to ensure that the appliance does not stand on the electrical supply cable.
- If the machine is situated on a carpeted floor, please adjust the feet in order to allow air to circulate freely.

Child Safety

- This appliance is designed to be operated by adults. Children should not be allowed to tamper with the controls or play with the product.
- Pets and children have been known to climb into washing machines. Please check your drum before use.
- The glass door becomes very hot during the washing and drying cycle. Keep children away from the vicinity of the appliance whilst it is in operation.
- Keep all packaging well away from children.
- Keep all detergents in a safe place out of children's reach.

Use

- Always unplug the appliance and turn off the water supply after use.
- Do not overload the appliance. See relevant section in the instruction book.
- Only wash fabrics which are designed to be machine washed. If in doubt, consult the care label on the clothes.



- Before washing, ensure that all pockets are empty and buttons and zips are fastened. Avoid washing frayed or torn articles and treat stains such as paint, ink, rust, and grass before washing. Underwired bras must NOT be machine washed.
- Any objects such as coins, safety pins, nails, screws, stones or any other hard, sharp material can cause extensive damage and must not be placed into the machine.
- Garments which have been in contact with volatile petroleum products should not be machine washed. If volatile cleaning fluids are used, care should be taken to ensure that the fluid is removed from the garment before placing in the machine.
- Wash small items such as socks, laces, washable belts etc in a washing bag or pillow case as it is possible for such items to slip down between the tub and the inner drum.
- Only use the advised quantities of fabric softener. Damage to the fabric can ensue if you over-fill. Refer to the manufacturer's recommendations of quantities.
- As some duvets and eiderdowns should be washed in large commercial machines because of their bulk, please check with the manufacturer of the item before washing in a domestic machine.
- Never tumble dry items that have had contact with chemicals such as dry cleaning fluid. These are of a volatile nature and could cause an explosion. Only tumble dry items which have been washed in water or require airing.
- Plastic detergent dispensers should not remain in the drum during the drying cycle, as the plastic used is not designed to withstand the heat. If you wish to wash-through-to-dry you should use the conventional detergent dispenser drawer.
- Leave the porthole door slightly ajar between washes to preserve the door seal.
- Under no circumstances should you attempt to repair the machine yourself. Repairs carried out by inexperienced persons may cause injury or serious malfunctioning. Contact your local Zanussi Service Force Centre. Always insist on genuine Zanussi spare parts.

Contents

For the User			
Important Safety Information	2		
Your New Washer Dryer	4		
Description of the Appliance	5		
Detergent dispenser drawer	5		
Child safety feature	5		
The Control Panel	6-10		
Programme Information	10		
Operating sequence	11-13		
Washing only	11		
Load the laundry	11		
Measure out the detergent and the fabric softener	11		
Jetsystem wash	11		
Switch the machine on	11		
Select the required programme	11		
Select the SPIN SPEED or RINSE HOLD option	12		
Select the required options	12		
Select the DELAY START	12		
Start the programme	12		
At the end of the programme	12-13		
Drying only	13		
Automatic washing and drying	13		
Washing and Drying Hints	14-15		
Which detergent?....	15		
And in which form?	15		
Wash Care Symbols	16		
Washing and Special Programmes	17-18		
Drying Programmes	19		
	24		
Maintenance and Cleaning		20-21	
Descaling		20	
After each wash		20	
Maintenance wash		20	
External cleaning		20	
Cleaning the dispenser drawer		20	
Cleaning the drawer recess		20	
Cleaning the filter		20	
The dangers of freezing		21	
Emergency emptying out		21	
Something Not Working		22-23	
Service and Spare Parts		23-24	
Guarantee conditions		24	
For the Installer			
Installation Instructions		25	
Technical Specifications		25	
Unpacking		26	
Positioning		26	
Water inlet		26-27	
Water drainage		27-28	
Levelling		28	
Special conditions		28	
In the interest of the environment		28	
Electrical connection		29	
Building-in		30-31	

Guide to use the Instruction Book

The following symbols will be found in the text to guide you throughout the instructions:

-  **Safety instructions**
-  **Hints and tips**
-  **Environmental information**

Your New Washer-Dryer

Your new washer-dryer fitted with the Zanussi "JET SYSTEM", meets all modern requirements for effective treatment of laundry with low water, energy and detergent consumption.

Even small loads are washed "economically" because the amount of water used is regulated automatically according to the load and type of fabric.

- **Automatic cooling of the wash water to 60°C** before draining, with the 95°C programme. This reduces thermal shock to fabrics, helping to prevent creasing.
- **The special WOOL programme** with its new delicate wash system treats your woollens with extreme care.
- **The anti-unbalance device** ensures that the washing machine remains stable when spinning.
- **The two drying programmes** will give your wash that soft, relaxed feel whatever the weather.

Ecological hints

To save water and energy and help protect the environment, we recommend that you follow these hints:

- Adjust the quantity of detergent according to the hardness of your water supply, the amount of laundry and the degree of soiling.
- Select an "economy" programme for lightly soiled laundry.
- A programme without prewash is sufficient for normally soiled laundry.
- The machine works more economically if it is fully loaded both for washing and drying cycles.
- With adequate pre-treatment, stains and limited soiling can be removed; the laundry can then be washed at a lower temperature.
- Always load well spun laundry. The higher the spin speed, the lower the electricity consumption and the shorter the drying times.

Important

Your machine is fitted with a balance control device, which ensures the machine is stable during the spin. If the wash load appears not to have been spun sufficiently at the end of the wash cycle, because it is not evenly distributed in the drum, the balance control device may have operated. It will therefore be necessary to redistribute the wash load manually and select a spin programme. For more detailed information see the section headed "Something Not Working".

In the interest of the environment

- Materials marked with the symbol  are recyclable.
- Check with your local Council or Environmental Health Office to see if there are facilities in your area for re-cycling this appliance.
- When the appliance is to be scrapped, cut off the power supply cable and make the door lock device unusable to prevent young children from being trapped inside.
- Help to keep your country tidy - use authorised disposal sites for your old appliance.

The symbol  on the product or on its packaging indicates that this product may not be treated as household waste. Instead it shall be handed over to the applicable collection point for the recycling of electrical and electronic equipment. By ensuring this product is disposed of correctly, you will help prevent potential negative consequences for the environment and human health, which could otherwise be caused by inappropriate waste handling of this product. For more detailed information about recycling of this product, please contact your local city office, your household waste disposal service or the shop where you purchased the product.



**How do we help to protect the environment?
We use recycled paper!**

Description of the Appliance

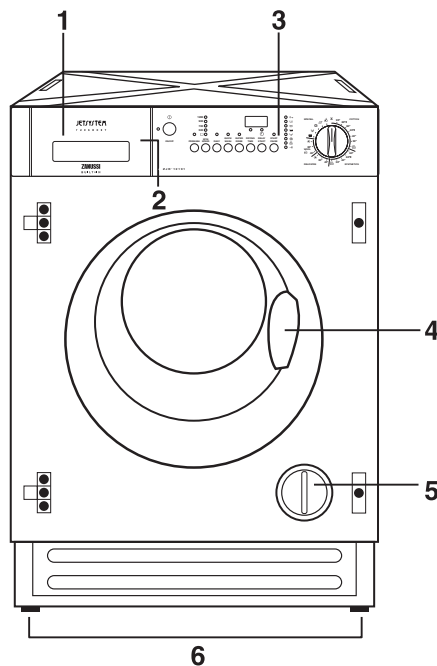
- 1 Detergent dispenser drawer
- 2 Programme guide
- 3 Control panel
- 4 Door opening handle
- 5 Filter
- 6 Adjustable feet



Detergent dispenser drawer

-  Prewash
-  Main wash
-  Fabric softener

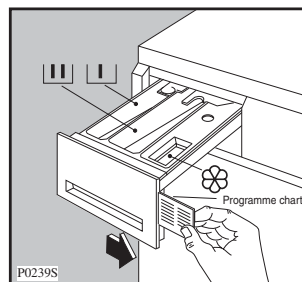

Child safety feature

This machine incorporates a special child safety feature to prevent small children from being trapped inside the machine.

To activate this device, rotate the button (without pressing it) inside the door clockwise until the groove is horizontal. If necessary use a coin.

To disable this device and restore the possibility of closing the door, rotate the button anti-clockwise until the groove is vertical.

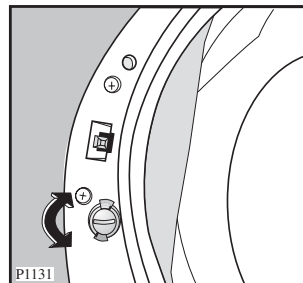

The Control Panel

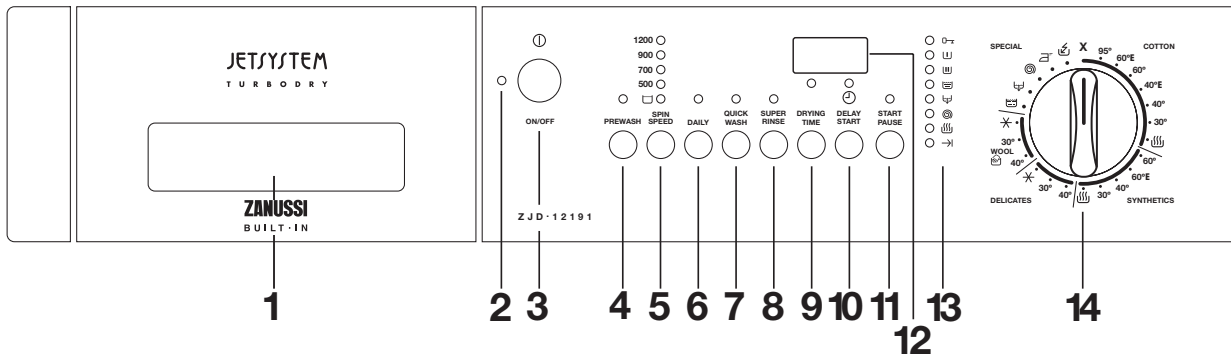

1 Detergent dispenser drawer

2 Mains-on light

This light comes on when the ON/OFF button is pressed, and goes out when it is pressed again.

3 ON/OFF button

Press this button to switch the machine on. Press it again to switch the machine off.

Programme Option buttons



Depending on the programme, different functions can be combined. These must be selected after choosing the desired programme and before depressing the START PAUSE button.

When these buttons are pressed, the corresponding pilot lights come on. When they are pressed again, the pilot lights go out.

If an incorrect option is selected, the corresponding pilot light flashes for about 2 seconds and the message **Err** is displayed.

4 PREWASH button

The machine performs a prewash cycle at 30°C max. The prewash cycle ends with a short spin at 650 r.p.m. in programmes for COTTON and SYNTHETICS, and with emptying of the water for DELICATES.



This option is **not** available with the WOOL programme/(handwash)  and Miniprogramme . For use when washing heavily soiled laundry.

5 SPIN SPEED button

Press this button to reduce the maximum speed of the final speed proposed by the machine for the selected programme or to select position  (RINSE HOLD).



The light corresponding to the selected option illuminates.

The following speeds are available for the different fabrics:



- **COTTON**, linen: 500/700/900 max 1200 r.p.m.
- **SYNTHETICS** and **WOOL/(handwash)**  : 500/700 max 900 r.p.m.
- **DELICATES** and **MINIPROGRAMME**  : 500 max 700 r.p.m.



The light corresponding to the selected option illuminates.

Rinse Hold

When RINSE HOLD option is selected, the last rinse water is not emptied out, to prevent the fabrics from creasing. When the programme has finished, the light of the START PAUSE button and the pilot light  (DOOR) go out, the light  and the pilot light  (END) are alight to indicate that the water must be emptied out.

To empty out water there are 2 possibilities:

- Select programme  (draining): The water is emptied out without spinning.
- Select programme  (spin): reduce eventually the spin speed by means of the relevant button and then depress the START PAUSE button. The water is emptied out and the laundry is spun at the selected spin speed.

Attention! Before selecting programmes  (Drain) or , the selector dial has to be positioned on **X** (cancelling).

The RINSE HOLD option CANNOT be selected for the automatic Washing & Drying programme.



6 DAILY button

This option can be used for lightly soiled **cotton** or **synthetic items** in order to obtain a good washing performance in a short time.

This option **cannot** be used with the Economy programmes **60°E** and **E°40** and Miniprogram  and also **not** in combination with QUICK WASH option .



7 QUICK WASH button

This option can be used for lightly soiled **cotton**, **synthetic or delicate items** that have been used or worn for a short time.

This option is **not** available with the **WOOL/ (handwash)**  programme, the Energy saving programmes (**60°E** and **40°E**) and Miniprogramme .

It **cannot** be used also in combination with DAILY option.

8 SUPER RINSE button

This option can be selected with all programmes, except the **WOOL/ HANDWASH**  and Miniprogramme .

The machine will add 2 rinses for cotton and 1 rinse for synthetics and delicates.

This option is recommended for people who are allergic to detergents and in areas where the water is very soft.

9 DRYING TIME button

By depressing this button you can select the desired drying time according to the fabrics (cotton or synthetics) you have to dry.

To select the drying time you have to push the button until the drying time you want appears in the display.

For COTTON and SYNTHETICS you can select a time from 10 to 130 minutes.

For automatic Washing & Drying programmes the drying time is displayed for 2 seconds, then the duration of the programme will appear.

10 DELAY START button

The wash programme can be delayed from 30 min - 60 min - 90 min, 2 hours and then by 1 hour up to a maximum of 23 hours by means of this button.

Selecting the delayed start

- Select the programme and the required options.
- Select the delay start.
- Depress START PAUSE button: the machine starts its hourly countdown.

The programme will start after the selected delay has

expired. The DELAY START **cannot** be used with  (**DRAIN**) or  (**SPIN**) programmes.

Cancelling the delayed start

- Depress START PAUSE button.
- Depress DELAY START button until «» is displayed.
- Depress START PAUSE button again, if you wish to restart the machine immediately.

11 START/PAUSE button

This button has two functions: Start - Pause

Start

After having selected the required programme, press this button to start the machine; the corresponding pilot light stops flashing.

If you have selected the delayed start, the machine begins its countdown. The duration of the programme or the delay appears on the display.

Pause

To interrupt a programme which is running, depress the START PAUSE button: the corresponding pilot light starts to flash.

To restart the programme from the point at which it was interrupted, **press the START PAUSE button again.**

12 DISPLAY

The display shows the following information:

Reset/Cancelling - Duration of the programme - Drying time - Delayed start - Incorrect option selection - Alarm code - End of programme

Reset/cancellation of the programme

If the programme selector dial is turned to **X** position, three blinking dashes are displayed.

Now you can select a new programme.

(If the programme selector dial has not turned to **X** position, when you press the ON/OFF button to switch the machine on, the display will show a blinking zero.)

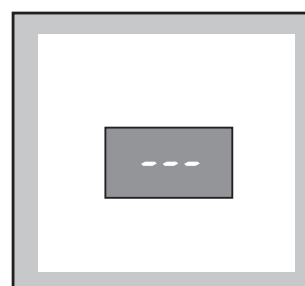

Duration of the selected programme

After selecting a programme, the duration is displayed in hours and minutes (for example **2.05**).



The duration is calculated automatically on the basis of the maximum recommended load for each type of fabric.

After the programme has started, the time remaining is updated every minute.

Drying time

The selected drying time is displayed in minutes.

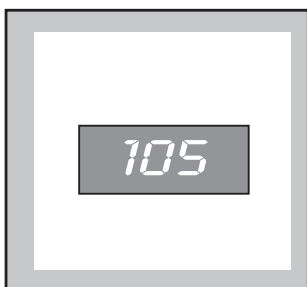

After starting the programme, the remaining time is updated every minute.

Delayed start

The selected delay (23 hours max) set by means of the relevant button appears on the display for 3 seconds, then the duration of the previously selected programme is displayed.

The countdown is updated every hour and, when remain the last 2 hours, each 30 min.

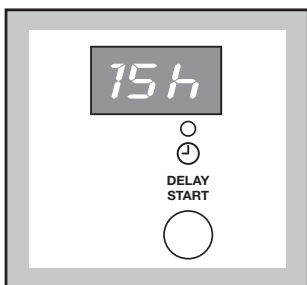

Incorrect option selection

If an option which is not compatible with the set wash programme is selected, the message **Err** is displayed for 2 seconds.

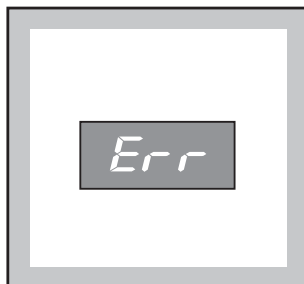

Alarm codes

In the event of operating problems, some alarm codes can be displayed, for example **E20** (see paragraph “Something not working”).

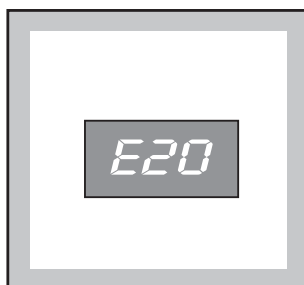

End of programme

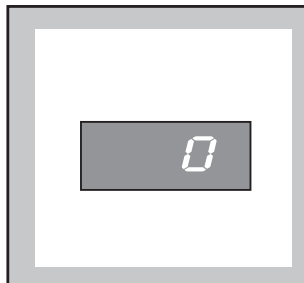

When the programme has finished a **flashing zero** is displayed. The door can be opened when (DOOR) pilot light has gone out and if the (RINSE HOLD) option **has not** been selected.



I3 Programme progress display



By selecting the wash programme, the pilot lights corresponding to the various phases making up the programme come on.

After the machine has started, the  (DOOR) pilot light and only the running phase light illuminate and stay on.

When the programme has finished, the  (END) pilot light comes on and the  (DOOR) pilot light goes off.



The  (DOOR) pilot light indicates if during the washing cycle the door can be opened:

- **Light on: the door can be opened**
(when the washer-dryer is set to PAUSE, the  (DOOR) pilot light will go off).
- **Light off:** the door cannot be opened
(when the washer-dryer is set to PAUSE, the  (DOOR) pilot light will start to flash)

The  (END) pilot light flashes in the event of operating problems and the corresponding alarm code appears on the display.

E10 = the machine does not fill

E20 = the machine does not empty

E40 = the door has not been closed

To eliminate the problem, see paragraph "Something not working".

I4 Programme selector dial

The selector is divided into 5 sections:

- COTTON,
- SYNTHETICS
- DELICATES
- WOOL  (hand washing)
- Special programmes

Reset programme X

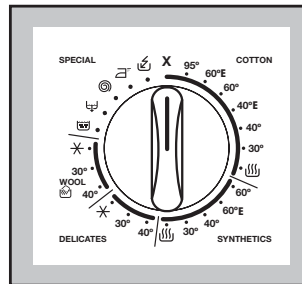

The selector dial can be turned either clockwise or anticlockwise.



Position **E** corresponds to the ENERGY SAVING programme and position **X** to "cold wash".

Position  corresponds to the drying programme.

At the end of the programme the selector dial must be turned to position X (reset).

Functions

End of programme

When the  (END) pilot light on the programme progress display illuminates, if the  (DOOR) pilot light has gone out, the door can be opened (if the  (RINSE HOLD) option **has not** been selected).

Turn the programme selector dial to **X**.

Switch the machine off by depressing the ON/OFF button before removing the laundry.

Altering an option or a running programme

It is possible to change any option before the programme carries it out.

Before you make any change, you must pause the washer dryer by pressing the START PAUSE button.

Changing a running programme is possible only by resetting it. Turn the programme selector dial to "X" and then to the new programme position. The washing water in the tub will not emptied out.

Start the new programme by depressing the START PAUSE button.

Interrupting a programme

Depress the START PAUSE button to interrupt a programme which is running: the corresponding light starts to flash.

Depress the same button to restart the programme.

Opening the door after the programme has started

You can open the door, after having set the washer-dryer to PAUSE, provided the following conditions exist:

- the drum temperature is not over 55°C;
- the level of the water is not high;
- the drum is not turning.

If these requirements are met, the  (DOOR) pilot light **will be on** and, when you pause the washing machine, it will go out: the door can be opened.

Should it not be possible to open the door, and should it be absolutely necessary to do so, switch the machine off by pressing the ON/OFF button.

After approximately 3 minutes, you can open the door.

Pay attention to the level and temperature of the water in the machine!

When you close the door and press the ON/OFF button again, the machine will resume the programme from the point where it had been interrupted.

Programme information

WOOL (HANDWASH)

Washing programme for machine washable wool as well as for hand washable woollens and delicate fabrics with the “hand washing” care symbol.

= Rinses

With this programme it is possible to rinse and spin cotton garments which have been washed by hand. The machine performs 3 rinses, followed by a final spin at 1200 r.p.m.
The spin speed can be reduced by depressing SPIN SPEED button.

= Drain

For emptying out the water of the last rinse in programmes with the RINSE HOLD option. Turn first the programme selector dial to **X**, then select programme  and depress the START PAUSE button.

= Spin

Separate long spin at the maximum speed for hand washed cotton garments. You can reduce the speed by means of SPIN SPEED button to adapt it to the fabrics to be spun.

= Easy to iron

With this programme the laundry is gently washed and spun to any creasing. In this way ironing is easier. To be used for synthetic items.

Washing temperature 40°C

Final spin speed 900 r.p.m.

= Miniprogramme

This is a complete programme that can be combined with the following options: SPIN SPEED, RINSE HOLD and DELAY START.

To be used for laundry which is lightly soiled or which needs freshening up.

Max load 2 kg.

Washing temperature 30°C

Programme duration 30 minutes

Final spin speed 700 r.p.m.

X = Cancelling

To reset a programme turn the selector dial to **X**. Now a new programme can be selected.

Operating Sequence

Washing only

Before the first wash, we recommend that you run a cotton cycle at 95°C, without any laundry in the machine, to remove any manufacturing residue from the drum and tub.

Pour 1/2 a measure of detergent into the main wash compartment  of the dispenser drawer and start the machine.

1. Load the laundry

Open the door by pulling the door handle outwards. Place the laundry in the drum, one item at a time, shaking them out as much as possible. Close the door.

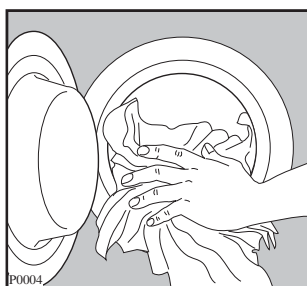

2. Measure out the detergent and the fabric softener

Pull out the dispenser drawer until it stops. Measure out the amount of detergent required and pour it into the main wash compartment .

If you have selected the **PREWASH** option, pour detergent into the compartment marked .

If required, pour fabric softener into the compartment marked  (the amount used must not exceed the "MAX" mark in the drawer). Close the drawer gently.

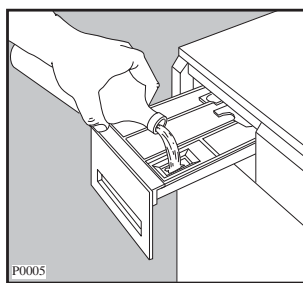
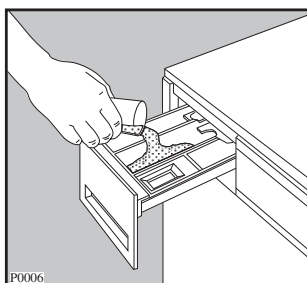

«JETSYSTEM» wash

As the Jetsystem is flexible and adjusts water intake according to wash load size it is not possible to give you exact recommendations as to the amount of detergent that should be used for any one wash.

Therefore we recommend that you use approximately 1/3 less than the detergent manufacturer recommends on the packet or bottle, making the appropriate allowances for soft or hard water, and light or heavy soilage of clothes. If you have judged the amount correctly you should expect to see a soft sudsy liquid during the wash. It is not necessary to have a head of lather on the water.

3. Switch the machine on

To switch the machine on, press the **ON/OFF** button: the mains-on light comes on. The display will show three flashing dashes or a blinking zero.

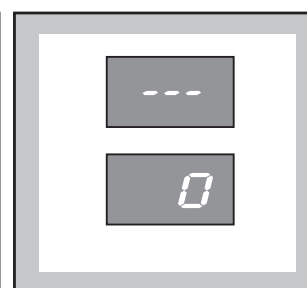
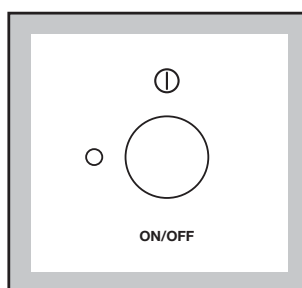

If the programme selector dial is on the Reset **X** position, three flashing dashes will be displayed. If the programme selector dial is positioned on a wash programme, a flashing zero appears on the display.

4. Select the required programme

Turn the programme selector dial to the desired position: the lights corresponding to the different phases making up the selected programme light on.

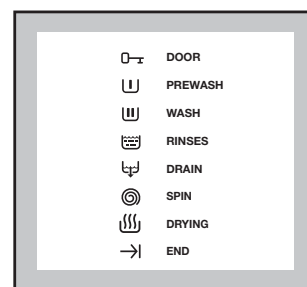
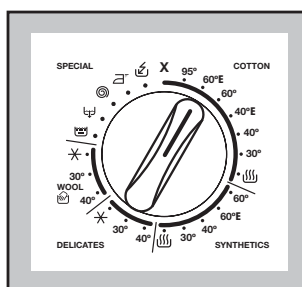

The display shows the duration of the programme.



5. Select the SPIN speed or RINSE HOLD option

Depress the spin speed button to choose the required speed or RINSE HOLD option  : the corresponding light comes on.

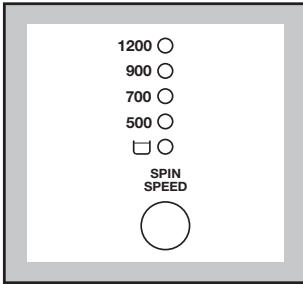

6. Select the required options

The light corresponding to the depressed button illuminates.

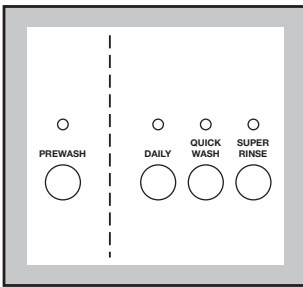

7. Select the Delay Start option

To delay starting of a programme, press the DELAY START button. The corresponding light illuminates. The figures corresponding to the selected delay will be displayed for about 3 seconds, after which the duration of the selected programme will appear on the display.

When the START PAUSE button is pressed, the selected delay will again appear on the display and the machine starts its countdown.

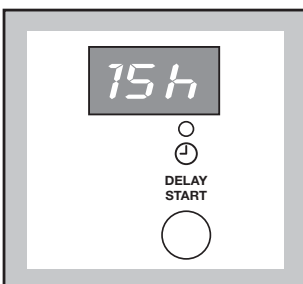

During this period it is possible to load other laundry: press the START PAUSE button. Open the door. Load the laundry. Close the door and press the START PAUSE button again.

8. Start the programme

To start the selected programme, press the START/PAUSE button; the corresponding light stops flashing and the  (Door) pilot light illuminates.

The pilot light corresponding to the wash phase which is running is on.

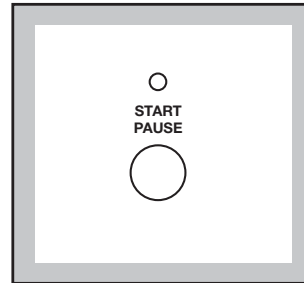

The machine starts operating.





If the DELAY START option has been selected the programme will start at the end of the countdown.



9. At the end of the programme

The machine stops automatically. The display shows a blinking zero.

If the RINSE HOLD  option has been selected, the door will be locked, the light of the START PAUSE button and the  (DOOR) pilot lights go out, the  light remains lit to indicate that the water must be drained before opening the door. The display shows a flashing zero.

To empty out the water you can after turning the programme selector dial to X position:

- select programme  (DRAIN), the water is emptied out without spinning
- select programme  (SPIN). Select the spin speed by means of the relevant button and then depress the START/PAUSE button. The water is emptied out and the laundry is spun at the selected spin speed.

At the end of the cycle, the light of the START PAUSE button and the  (DOOR) pilot light go out, and the  (END) light illuminates. The door can be opened.

Turn the programme selector dial to Reset X.

Switch the machine off by pressing the ON/OFF button. Remove the laundry from the drum and carefully check that the drum is empty so as to avoid any forgotten items being damaged in a subsequent wash (e.g. shrinking) or their colour running into a load of whites. If you do not intend to carry out another wash, close the water tap.

Leave the door open to prevent the formation of mildew and unpleasant smells.

Drying only

Warning! Do not exceed the maximum laundry loads:

- 2.5 kg for linen and cottons
- 2 kg for synthetics.

The water tap must be open and the drain hose must be positioned in the sink or connected to the drain pipe.

1. Load the laundry
2. Depress the ON/OFF button to switch the machine on.
3. Select the drying programme  (for COTTON or SYNTHETICS).
4. Depress the **DRYING TIME** button until the time you want appears in the display. The corresponding light comes on.
5. Press the START PAUSE button to start the programme.
6. At the end of the cycle, turn the programme selector dial to Reset **X** and press the ON/OFF button again to switch the appliance off.
7. Remove the laundry.

Automatic washing and drying (NON-STOP programme)

Warning! For NON-STOP programmes, it is also essential not to exceed the maximum load sizes of 2.5 kg for cotton and 2 kg for synthetics.

1. Load the laundry.
2. Add detergent and fabric softener.
Do not use dosing device/ball when carrying out the NON-STOP programme because the plastic material is not designed to withstand the high drying temperature.
3. Switch the machine on by depressing the ON/OFF button.
4. Select the wash programme.
5. Select eventually the required options by means of the relevant buttons. If possible, do not select a spin speed lower than that proposed by the appliance to avoid a too long drying time so saving energy. In any case the reduction of the spin speed is only possible after selecting drying. The lowest values you can select are the following:
- 900 r.p.m. for COTTONS and 700 r.p.m. for SYNTHETICS
6. Select the drying time.
7. Start the programme by depressing the START PAUSE button.
8. At the end of the programme, turn the selector dial to Reset **X** and press the ON/OFF button again to switch the machine off.
9. Remove the laundry.

Washing and Drying Hints

Do **NOT** overload the machine. Weigh the laundry the first few times you use the appliance.

The average weights of the most common items are listed below as a guide:

1000g = 1 kg

Sheet	700-1000 g
Pillow case	100-200 g
Tablecloth	400-500 g
Serviette	50-100 g
Tea towel	70-120 g
Linen hand towel	100-150 g
Towelling hand towel	150-250 g
Towelling bath towel	700-1000 g
Bath robe	1000-1500 g
Man's shirt	200-300 g
Apron	150-200 g

- Load the laundry loosely alternating large items with small ones.
- Sort the laundry according to the type of fabric, colour-fastness and how dirty it is.
- Avoid washing unhemmed or torn items as they may unravel.
- Before washing, empty all pockets of small objects which may have been left inside (coins, keys, screws etc). as these could damage the drain pump.
- When washing curtains, remove the hooks.
- Close poppers and zips and fasten loose buttons.
- It is essential to wash new coloured items separately when washing for the first time.
- When washing fabrics requiring different wash temperatures together, always select the lowest temperature.
- White items should not be washed with coloured items.
- Very small items (handkerchiefs, ribbons, socks etc) should be washed in a washing bag or a pillow case.
- Use a good quality detergent suitable for automatic washing machines.
- Use the correct quantities of detergent.
- For wool, use gentle detergent only in small quantities.
- Bleach is very corrosive; it should be used with care and kept out of reach of children.

- Some stains such as fruit, wine, grass, rust etc. are difficult to remove and should be treated before washing with specific products, which can be found in most household shops. In some cases it may help to soak the stain before washing with a special pre-soak product or biological detergent.
- If you have used the machine to wash, rinse or spin only non-colour fast garments, there may be dye left in the sump. To ensure any subsequent wash is not contaminated with the dye, select and carry out a rinse and spin programme, without any garments, to ensure that any dye is removed from the sump.
- Do not leave the damp laundry load in a heap too long before drying.
- Avoid drying dark clothes with light coloured fluffy items such as towels as these can attract the fluff.
- If you overdry the laundry, besides wasting energy, any subsequent ironing may become more difficult because the fabric could be heavily crumpled.
- Remove the laundry when the appliance has finished drying.
- To avoid a static charge when drying is completed, use either a fabric softener when you are washing the laundry or a fabric conditioner specifically for tumble dryers.
- Particularly delicate items such as synthetic curtains, woollen and silk, garments with metal inserts, nylon stockings, bulky garments such as anoraks, bedcovers, quilts, sleeping bags and duvets must not be machine dried.
- Garments padded with foam-rubber or materials similar to foam-rubber must not be machine dried; they represent a fire hazard.
- Also, fabrics containing residues of setting lotions or hair sprays, nail solvents or similar solutions must not be machine dried in order to avoid the formation of harmful vapours.
- For drying, follow the indications given on the manufacturer's labels.
 - May be tumble dried
 - Drying at high temperature
 - Drying at reduced temperature
 - Do not tumble dry

Important: As a dryer, the machine works on the condensation principle.

Therefore, the water taps must be open and the drain hose must drain water into a sink or into the drain pipe, even during the drying cycle.

Which detergent?....

To ensure you obtain the best wash results from your appliance, it is important to use the right detergent in your everyday wash, and only detergents recommended for use in automatic machines.

To maintain the appearance of your clothes and household textiles and to make them last longer you should use different types of detergent for different washes, whether for whites, colours or delicates.

WHITES

We recommend the Ariel product range which is biological and designed to provide excellent cleaning and stain removal even at low temperatures.



NON BIOLOGICAL

If you prefer to use a non biological detergent, which does not contain enzymes we recommend Fairy. Fairy provides good cleaning and stain removal.



COLOURED

For coloured items you should use a detergent which is designed to clean while maintaining the original colour.

Ariel Color does not contain bleach and therefore helps to preserve colours.



DELICATE ITEMS

When washing delicates such as woollens, you should use a product which is specially designed to care for fine fabrics.

Dreft Automatic is suitable for woollens and other delicates.



LAUNDRY BLEACH

For additional stain removal you may wish to use a product such as Ace Gentle Bleach which is used in addition to your chosen detergent. Ace is suitable for all washable fabrics including silks, woollens and coloureds.



And in which form?

Not only are there different types of detergent, but they are also available in different forms. Whether you chose a powder or liquid in traditional or compact form is your own personal choice.

TRADITIONAL POWDERS

Pour the powder directly into the dispenser drawer. Do not sprinkle powder onto clothes in the machine drum.

TRADITIONAL LIQUIDS

Liquid can be placed in the main wash compartment of the detergent drawer marked with the symbol , start the machine immediately upon placing the detergent in the dispenser drawer.

Alternatively the detergent is measured into the specially designed dosing device* which should be placed on top of the laundry, and at the back of the machine drum.

COMPACT POWDERS AND LIQUIDS

Compact detergents (or concentrates as they are also known) are available in liquid or powder form, and generally require a smaller dosage. Follow the manufacturer's instructions to ensure the most economical usage. Pour the detergent directly into the dispenser drawer, or alternatively measure the detergent into the specially designed dosing device* which should be placed on top of the laundry, and at the back of the machine drum.

* If you use a dosing device in a washer dryer, please ensure the dosing device/ball is removed before carrying out a drying programme.

FABRIC CONDITIONERS

These are ideal for improving 'softness', and also reduce static cling on synthetics and make ironing easier. They are available in two types:

For example Lenor liquid fabric softener, for use in the **washing machine/washer dryer**. The liquid fabric softener should be poured into the compartment marked with the symbol . Follow the manufacturer's dosage instructions and never exceed the MAX level.

















Bounce conditioning sheets for use in a **tumble dryer**. We recommend the conditioning sheets are pinned (using a safety pin) to an article of laundry and placed in the tumble dryer.



Wash Care Symbols

Wash care labels inside garments recommend how to launder your clothes with the best results. The care labelling code is in line with care labelling used in the rest of Europe. The symbols used make it easy to select the correct programme on your washing machine.

WASHING SYMBOL	WASH ACTION	FABRIC
	Normal (Maximum)	White Cotton or Linen without Special Finishes
	Normal (Maximum)	Cotton, Linen or Viscose without Special Finishes Colourfast at 60°C.
	Reduced (Medium)	Nylon, Polyester/Cotton, Viscose with Special Finishes, Cotton/Acrylic Mix.
	Normal (Maximum)	Cotton, Linen or Viscose Colourfast at 40°C but not 60°C.
	Reduced (Medium)	Acrylics, Acetate, Triacetate, Wool mixes, Polyester/wool blends.
	Much Reduced (Minimum)	Wool, wool mixtures, Silks
	Hand wash only	Do not machine wash
BLEACHING		
	Chlorine bleach may be used	
IRONING		
	Hot iron	Cotton, Linen, Viscose
	Warm iron	Polyester mixtures, Wool
	Cool iron	Acrylic, Nylon, Polyester
DRY CLEANING		
	May be dry cleaned. Other letters and/or a bar beneath the circle will indicate the required process to the dry cleaner.	
TUMBLE DRYING		
	with high heat setting	
	with low heat setting	
	May be tumble dried	
X	A cross through any symbol means « DO NOT »	

Important Notes

For best results, always use the dispenser drawer for dispensing detergents and liquid additives. Once the dispenser has been filled, close it by pushing it in gently. This is particularly important if you are using

fabric conditioner to avoid the conditioner entering the machine prematurely. When using liquid detergent and a prewash programme, place the detergent into the correct compartment in the dispenser drawer, after the prewash has finished.





Washing Programmes

Section	Temp.	Type of fabric	Programme description	Additional functions	Max. load	Consumption*		
						Energy kWh	Water lt	Time min
COTTON	95°	Whites	Wash at 95°C 3 rinses Normal spin	SPIN SPEED RINSE HOLD PREWASH DAILY, QUICK SUPER RINSE	5 kg	1.9	52	142
*COTTON	60°E	Whites Economy	Wash at 60°C 3 rinses Normal spin	SPIN SPEED RINSE HOLD PREWASH SUPER RINSE	5 kg	0.85	49	136
COTTON	60°	Whites and Fast coloureds	Wash at 60°C 3 rinses Normal spin	SPIN SPEED RINSE HOLD PREWASH DAILY, QUICK SUPER RINSE	5 kg	1.2	49	121
COTTON	40°E	Coloureds ECONOMY	Wash at 40°C 3 rinses Normal spin	SPIN SPEED RINSE HOLD PREWASH SUPER RINSE	5 kg	0.9	49	141
COTTON	30°-40°	Non-fast coloureds	Wash at 30°-40° 3 rinses Normal spin	SPIN SPEED RINSE HOLD PREWASH SUPER RINSE DAILY, QUICK	5 kg	0.7	49	118
SYNTHETICS	60°	Synthetics	Wash at 60°C 3 rinses Delicate spin	SPIN SPEED RINSE HOLD PREWASH SUPER RINSE DAILY, QUICK	2 kg	0.85	41	89
SYNTHETICS	60°E	Synthetics ECONOMY	Wash at 42°C 3 rinses Delicate spin	SPIN SPEED, PREWASH RINSE HOLD SUPER RINSE	2 kg	0.5	41	89
SYNTHETICS	30°-40°	Synthetics	Wash at 30°-40°C 3 rinses Delicate spin	SPIN SPEED RINSE HOLD PREWASH SUPER RINSE DAILY, QUICK	2 kg	0.45	38	79
DELICATES	30°-40° Cold ✱	Delicates	Wash at 30°-40°C or cold wash ✱ 3 rinses Delicate spin	SPIN SPEED, QUICK PREWASH RINSE HOLD SUPER RINSE	2 kg	0.55	58	58
WOOL 	30°-40° Cold ✱	Wool and Handwash	Wash at 30°-40°C or cold wash ✱ 3 rinses Delicate spin	SPIN SPEED RINSE HOLD	1 kg	0.4	58	57

*The "Cotton Whites Economy" at 60°E C is the reference programme for the data entered in the energy label, in compliance with EC 92/75 standards.

This data is given purely as an indication: the consumption values may vary in relation to the quantity and type of laundry, the temperature of the water supply and the ambient temperature. The data refers to the highest temperature for each programme.

Special Programmes

Selector dial position	Programme	Programme description	Additional functions	Max. load	Consumption*		
					Energy kWh	Water lt	Time min
	Rinses	3 rinses with liquid additive if required Long spin	SPIN SPEED RINSE HOLD SUPER RINSE	5 kg	0.1	40	47
	Drain			5 kg	-	-	2
	Spin	Separate long spin at 1200 rpm max	SPIN SPEED	-	-	-	10
	Easy Iron	Wash at 40°C 4 rinses Short spin at 900 r.p.m.	PREWASH SPIN SPEED RINSE HOLD DAILY, QUICK SUPER RINSE	1 kg	0.35	39	102
	Miniprogramme	Wash at 30°C 2 rinses Short spin at 700 r.p.m.	SPIN SPEED RINSE HOLD	2.5 kg	0.3	40	30
X	Reset	For cancelling the wash programme which is running				-	-

This data is given purely as an indication: the consumption values may vary in relation to the quantity and type of laundry, the temperature of the water supply and the ambient temperature.

Drying Programmes

Degree of drying	Type of fabric	Max. load	Spin speed	Drying time mins
Extra dry Ideal for towelling materials	Cotton and linen (bathrobes, bath towels, etc.)	2.5 kg	1200	110-120
		1 kg	1200	55-65
Store dry (*) Suitable for items to put away without ironing	Cotton and linen (towels, T-shirts, bathrobes)	2.5 kg	1200	100-110
		1 kg	1200	45-55
	Synthetics and mixed fabrics (jumpers, blouses, underwear, household linen)	1.5 kg	900	100-110
		1 kg	900	55-65
Iron dry Suitable for ironing	Cotton and linen (sheets, tablecloths, shirts, etc.)	2.5 kg	1200	70-80
		1 kg	1200	35-40

(*) The STORE DRY drying programme for cotton is the reference programme for the Energy Label data, in compliance with EC directive 92/75.

Maintenance and Cleaning

Before any maintenance or cleaning is carried out you must **DISCONNECT** the appliance from the electricity supply.

Descaling

The water we use normally contains lime. It is a good idea to periodically use a water softening powder in the machine. Do this separately from any laundry washing, and according to the softening powder manufacturer's instructions. This will help to prevent the formation of lime deposits.

After each wash

Leave the door open for a while. This helps to prevent mould and stagnant smells forming inside the appliance. Keeping the door open after a wash will also help to preserve the door seal.

Maintenance Wash

With the use of low temperature washes it is possible to get a build up of residues inside the drum. We recommend that a maintenance wash be performed on a regular basis.

To run a maintenance wash:

- The drum should be empty of laundry.
- Select the hottest cotton wash programme.
- Use a normal measure of detergent, must be a powder (such as Ariel Futur).

External cleaning

Clean the exterior cabinet of the appliance with soap and water only, and then dry thoroughly.

Cleaning the dispenser drawer

The washing powder and additive dispenser drawer should be cleaned regularly. Remove the drawer by pressing the catch downwards and by pulling it out. Flush it out under a tap, to remove any traces of accumulated powder. To aid cleaning, the top part of the additive compartment should be removed.

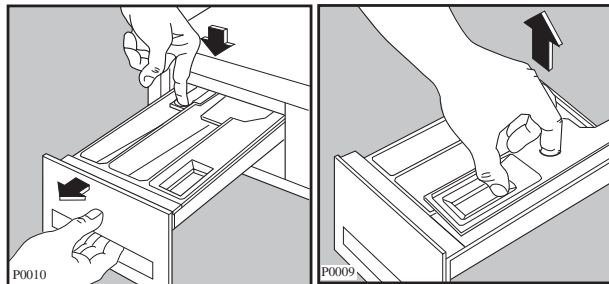

Cleaning the drawer recess

Having removed the drawer, use a small brush to clean the recess, ensuring that all washing powder residue is removed from the upper and lower part of the recess. Replace the drawer and run the rinse programme without any clothes in the drum.

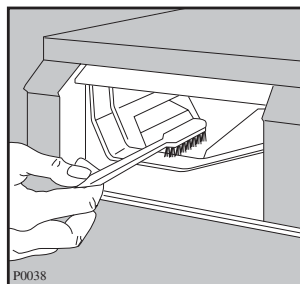

Cleaning the filter

The water drain filter

A clean filter is important for the correct functioning of the machine, and should therefore be cleaned after every washing and drying programme.

Place a container under the filter to catch any spillage. If the filter is blocked and the machine is unable to drain you will need to drain the water manually from the machine at this stage. To do this, unhook the drain hose from the standpipe or sink and hold the end of the hose over a bowl on the floor. The water should drain by gravity into the bowl. When the bowl is full, hook the hose back up and empty the bowl. Repeat the procedure until water stops flowing out.

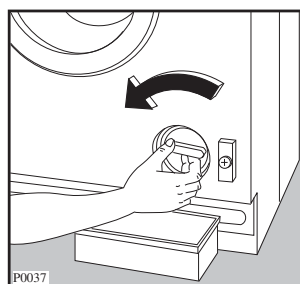

Unscrew and remove the filter.

Clean carefully under a fast running tap.

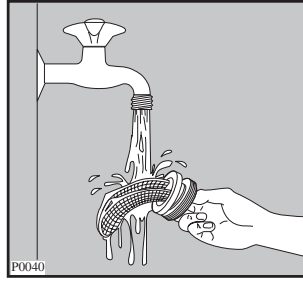
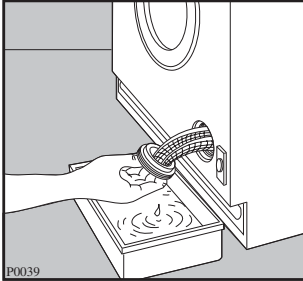

Warning

When the appliance is in use and depending on the programme selected there can be hot water in the filter. Never remove the filter during a wash cycle, always wait until the appliance has finished the cycle, and is empty. When replacing the filter, ensure it is securely retightened so as to stop leaks and young children being able to remove it.

The water inlet filter

If your water is very hard or contains traces of lime deposit, the water inlet filter may become clogged.

It is therefore a good idea to clean it from time to time.

Turn off the water tap. Unscrew the water inlet hose. Clean the filter using a hard bristle brush.

Tighten up the inlet hose.

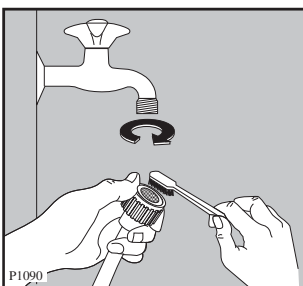

The dangers of freezing

If the machine is exposed to temperatures below 0°C, certain precautions should be taken.

- Turn off the water tap.
- Unscrew the inlet hose.
- Unhook the drain hose from the rear support and position the end of this hose and that of the inlet hose in a bowl. Run the draining programme.
- Disconnect the appliance.
- Screw the inlet hose and reposition the drain hose.
- When you intend to start the machine up again, make sure that the room temperature is above 0°C.

Emergency emptying out

If the water is not discharged, proceed as follows to empty out the machine:

- pull out the plug from the power socket;
- close the water tap;
- if necessary, wait until the water has cooled down;
- Unscrew and remove the filter;
- place a bowl on the floor. The water should drain by gravity into the bowl. When the bowl is full, empty the bowl. Repeat the procedure until water stops flowing out;
- clean the filter if necessary as previously described;
- screw the filter again.

Something Not Working

Certain problems are due to lack of simple maintenance or oversights, which can be solved easily without calling out an engineer. Before contacting your local Service Force Centre, please carry out the checks listed below.

IMPORTANT: if you call out an engineer to a fault listed below, or to repair a fault caused by incorrect use or installation, a charge will be made even if the appliance is under guarantee.

During machine operation it is possible that the →| (END) starts to flash and an alarm code appears on the display:

- **E10**: problem with the water supply
- **E20**: problem with water draining
- **E40**: door open

Once the problem has been eliminated, press the START/PAUSE button to restart the programme. If after all checks, the problem persists, contact your local Service Force Centre.

Symptom	Possible causes
The machine does not start	<ul style="list-style-type: none"> ● The door has not been closed. (E40) ● The plug is not properly inserted in the power socket. ● There is no current at the socket ● The main fuse or the fuse in the plug has blown. ● The selector dial is not correctly positioned. ● The START PAUSE button has not been depressed. ● The DELAY START option has been selected.
The machine does not fill	<ul style="list-style-type: none"> ● Ensure the water tap is open. (E10) ● The filter in the inlet hose is blocked. (E10) ● The inlet hose may be squashed or kinked. (E10) ● The door has not been closed. (E40)
The machine fills then empties immediately	<ul style="list-style-type: none"> ● The end of the drain hose is too low. ● The end of the drain hose is submerged in water. ● There is no vent in the end of the drain hose.
The machine does not empty and/or does not spin	<ul style="list-style-type: none"> ● The drain hose may be squashed or kinked. (E20) ● The RINSE HOLD option has been selected. ● The drain filter may be blocked. (E20) ● The drain hose extension is not correct. Follow the instructions for connecting to the waste. ● The drainage system pipes are blocked. (E20) ● The wash load is unbalanced: redistribute the clothes inside the drum to allow the machine to spin.
There is water on the floor	<ul style="list-style-type: none"> ● Too much detergent or unsuitable detergent has been used (creates too much foam). ● Check whether there are any leaks from one of the inlet hose fittings. It is not always easy to see this as the water runs down the hose; check to see if it is damp. ● The drain hose may be damaged or not securely positioned. ● The detergent dispenser drawer or recess is clogged. ● The drainage system pipes are blocked.
Unsatisfactory washing results	<ul style="list-style-type: none"> ● Too little detergent or unsuitable detergent has been used. An insufficient amount of detergent leaves the laundry looking grey and causes lime scale to form. ● Stubborn stains have not been treated prior to washing ● The correct wash programme has not been selected. ● Too much laundry has been placed in the drum.

Symptom	Possible causes
The machine vibrates when spinning	<ul style="list-style-type: none"> • The internal packing has not been removed. • The machine is in contact with the wall or furniture. • The machine is not level. • The washing load is badly distributed in the drum. • Maybe there is very little laundry in the drum.
The door will not open	<ul style="list-style-type: none"> • The water level is above the bottom edge of the door. • The machine is heating the water or drying the clothes. • The drum is turning.
Spinning starts late or the machine does not spin	<ul style="list-style-type: none"> • The electronic unbalance detection device has cut in because the laundry is not evenly distributed in the drum. The laundry is redistributed by reverse rotation of the drum. This may happen several times before the unbalance disappears and normal spinning can resume. If, after 10 minutes, the laundry is still not evenly distributed in the drum, the machine will not spin. In this case, redistribute the load manually and select the spin programme.
The machine makes an unusual noise	<ul style="list-style-type: none"> • The machine is fitted with a type of motor which makes an unusual noise compared with other traditional motors. This new motor ensures a softer start and more even distribution of the laundry in the drum when spinning, as well as increased stability of the machine.
No water is visible in the drum	<ul style="list-style-type: none"> • Machines based on modern technology operate very economically using very little water without affecting performance.
The machine does not dry or does not dry properly	<ul style="list-style-type: none"> • The drying time has not been selected. • The water tap is not turned on. (E10) • The drain filter is clogged. (E20) • The machine is overloaded. • The selected drying time or drying sector is not suitable for the laundry.

Service & Spare Parts **SERVICE FORCE**

In the event of your appliance requiring service, or if you wish to purchase spare parts, please contact your local Service Force Centre by telephoning:

0870 5 929929

For the address of your local Service Force Centre and further information about Service Force, please visit the website at www.serviceforce.co.uk.

For Customer Service in Ireland please contact us at the address below:

Zanussi
Electrolux Group (Irl) Ltd
Long Mile Road
Dublin 12
Republic of Ireland

Tel: +353 (0)1 4090751

Email: service.eid@electrolux.ie

Before calling out an engineer, please ensure you have read the details under the heading "Something Not Working".

When you contact the Service Force Centre you will need to give the following details:

1. Your name, address and post code
2. Your telephone number
3. Clear and concise details of fault
4. The model and serial number of the appliance (found on the rating plate - see picture)
5. The purchase date.

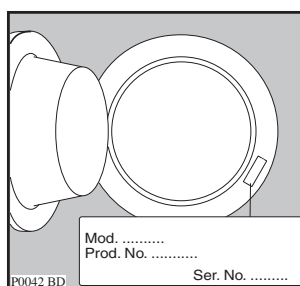

Customer

For general enquiries concerning your Zanussi appliance or for further information on Zanussi products, please contact our Customer Care Department by letter or telephone at the address below or visit our website at www.zanussi.co.uk

Customer Care Department - Zanussi

Major Appliances

Addington Way

Luton

Bedfordshire

LU4 9QQ

Tel 08705 727 727*

* calls to this number may be recorded for training purposes.

Guarantee Conditions

Standard guarantee conditions

We, Zanussi, undertake that if, within 24 months of the date of the purchase, this Zanussi appliance or any part thereof is proved to be defective by reason only of faulty workmanship or materials, we will, at our option, repair or replace the same **FREE OF ANY CHARGE** for labour, materials or carriage on condition that:

- The appliance has been correctly installed and used only on the electricity supply stated on the rating plate.
- The appliance has been used for normal domestic purposes only, and in accordance with the manufacturer's instructions.
- The appliance has not been serviced, maintained, repaired, taken apart or tampered with, by any person not authorised by us.

All service work under this guarantee must be undertaken by an Zanussi Service Force Centre. Any appliance or defective part replaced shall become the Company's property.

This guarantee is in addition to your statutory and other legal rights.

Home visits are made between **8.30am** and **5.30pm**

Monday to Friday. Visits may be available outside these hours in which case a **premium** will be charged.

Exclusions

This guarantee does not cover:

- Damage or calls resulting from transportation, improper use or neglect, the replacement of any light bulbs or removable parts of glass or plastic.
- Costs incurred for calls to put right an appliance which is improperly installed or calls to appliances outside the United Kingdom.

- Appliances found to be in use within a commercial environment, plus those which are subject to rental agreements.
- Products of Zanussi manufacture which are NOT marketed by Zanussi.

European guarantee





If you should move to another country within Europe then your guarantee moves with you to your new home subject to the following qualifications:

- The guarantee starts from the date you first purchased your product.
- The guarantee is for the same period and to the same extent for labour and parts as exists in the new country of use for this brand or range of products.
- The guarantee relates to you and cannot be transferred to another user.
- Your new home is within the European Community (EC) or European Free Trade Area.
- The product is installed and used in accordance with our instructions and is only used domestically, i.e. a normal household.
- The product is installed taking into account regulations in your new country.

Before you move please contact your nearest Customer Care Centre, listed below, to give them details of your new home. They will then ensure that the local Service Organisation is aware of your move and able to look after you and your appliances.

France	Senlis	+33 (0) 344 62 29 29
Germany	Nurnberg	+49 (0) 800 234 7378
Italy	Pordenone	+39 0434 39 4700
Sweden	Stockholm	+46 (0) 8 672 53 90
UK	Luton	+44 (0) 8705 727 727
Ireland	Dublin	+353 (0) 1 4090751

Installation Instructions

-  It is dangerous to alter the specifications or attempt to modify this product in any way.
-  Care must be taken to ensure that the appliance does not stand on the electrical supply cable.
-  Any electrical work required to install this appliance should be carried out by a qualified electrician or competent person.
-  Any plumbing work required to install this appliance should be carried out by a qualified plumber or competent person.

Technical Specifications

DIMENSIONS	Height Width Depth	82 cm (32.3") 60 cm (23.6") 54 cm (21.2")
POWER SUPPLY VOLTAGE TOTAL POWER ABSORBED		230-240 V/50 Hz 2050 W (10A)
WATER PRESSURE	Minimum Maximum	0.05 MPa 0.8 MPa
MAX. LOAD CAPACITY	Washing: Cotton, linen Synthetics Delicate fabrics Wool (Handwash ) Drying: Cotton, linen Synthetics	5 kg 2 kg 2 kg 1 kg 2.5 kg 1.5 kg
SPIN SPEED	Maximum	1200 rpm
CONSUMPTION DATA FOR WASHING 5 KG NORMALLY SOILED COTTON ITEMS WITH THE ECONOMY PROGRAMME 60°E	Energy Water Time	0.85 kWh 49 litres 145 mins

-  This appliance complies with the following E.E.C. Directives:
- 73/23 EEC of 19.2.73 (Low Voltage Directive) and subsequent modifications;
 - 89/336 EEC of 3.5.89 (Electromagnetic Compatibility Directive) and subsequent modifications.

Unpacking



All transit bolts and packing must be removed before using the appliance.

You are advised to keep all the packaging for re-use in case the machine is to be transported again.

Using a spanner unscrew and remove the rear right bolt. Lay the machine gently on its back, making sure that the hoses are not squashed.

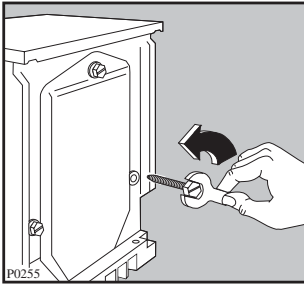

Remove the polystyrene base and take off the bottom panel by unscrewing the central screw. Carefully slide out the right polythene bag.

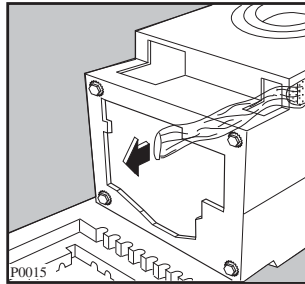
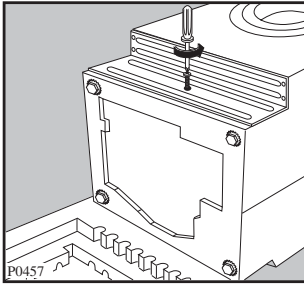

Repeat the operation for the left and central polythene bags.

Re-fit the bottom panel using the 4 screws supplied with the door hinges (in the plastic bag) and the previously removed screw.

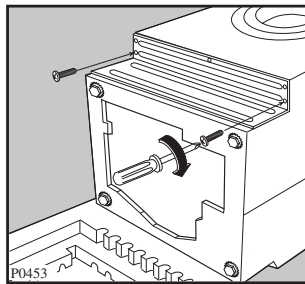
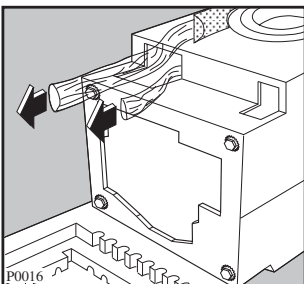

Set the machine upright and remove the two remaining bolts from the back.

Pull out the three plastic spacers from the holes into which the bolts were fitted.

Plug the open holes with the plugs supplied with the instruction booklet.

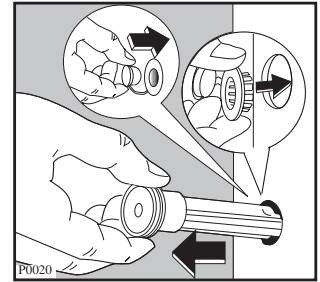
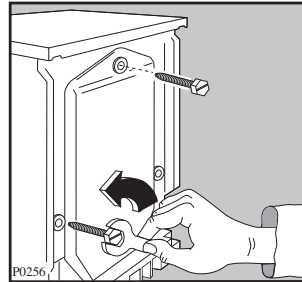

Positioning

Install the machine on a flat hard floor.

Make sure that air circulation around the machine is not impeded by carpets, rugs etc. Check that the machine does not touch the wall or other kitchen units.

Never place cardboard, wood or similar materials under the machine to compensate for any unevenness in the floor.

Your new washer-dryer has been designed to be permanently plumbed in to your home's water supply and drainage system. However, if this is not possible, it may be connected to a suitable existing tap with the drain hose discharging into a sink.

The appliance has an inlet hose, with female 3/4" BSP thread connector. If this connection is not compatible with the plumbing of the existing installation, a variety of connectors are available from good hardware stores and plumbers merchants to suit most domestic plumbing. Any alteration to your existing plumbing must be carried out by a competent person, or qualified plumber.

Water inlet

Connect the hose to a tap with a 3/4" thread.

Do not use previously employed hoses.

Installation should comply with local water authority and building regulations' requirements.

The appliance must be connected to a cold water supply.

A minimum water pressure of 0.05 MPa (0.5 bar) is required for safe operation of the appliance

If you cannot make the cold water connection direct from the rising mains, you may be able to operate the appliance from your cold water storage system.

There should be a minimum distance of 5.02m (16.5 ft) between the appliance's inlet and the bottom of the water storage tank.

Set the hoses correctly by loosening the ring nuts. After positioning the inlet hoses, be sure to tighten the ring nuts again to prevent leaks.

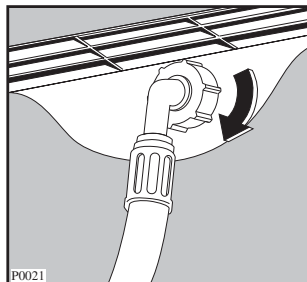
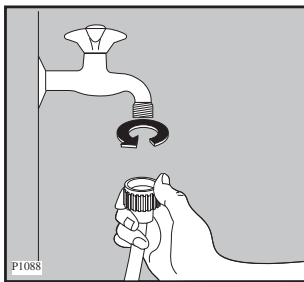

Water drainage

This appliance is designed to be permanently plumbed into your home's drainage system using one of the following methods.

1. Into a drainage standpipe.

Firstly form a hook in the end of the drain hose using the "U" piece" supplied.



Place the drain hose into your standpipe, which should have an internal diameter of approximately 38mm thus ensuring there is an air break between the drain hose and standpipe.

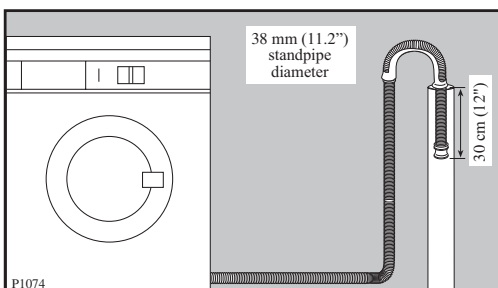

When discharging into a standpipe ensure that the top of the standpipe is no more than 90cm (35.4") and no less than 60cm (23.6") above floor level.

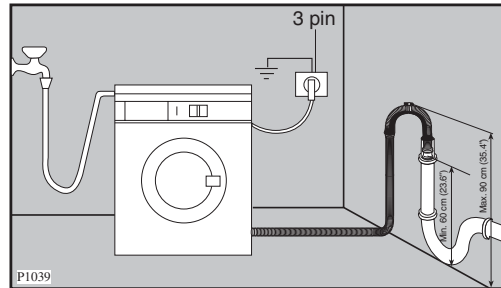

The drain hose may be extended to a maximum of 4 metres. An additional drain hose and joining piece is available from your local Service Force Centre. The joining piece must have an internal diameter of 18mm.

If your drain hose looks like this (see below) you do not require the "U" piece". Just push the hose firmly into the standpipe.

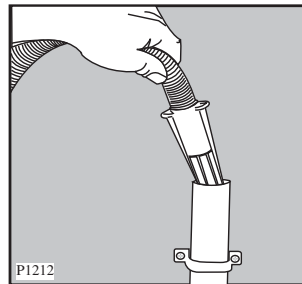

2. Onto a sink outlet spigot.

If the outlet spigot has not been used before, remove any blanking plug that may be in place.

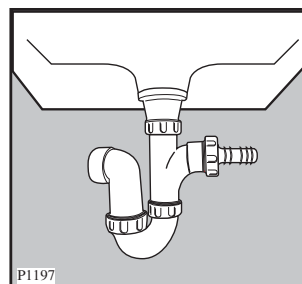

Push the drain hose onto the spigot and secure with a clip if required, ensure a loop is formed in the drain hose (see diagram) to prevent waste from the sink entering the washer dryer.

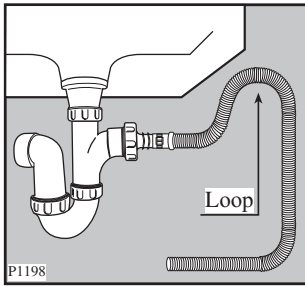

The drain hose may be extended to a maximum of 4 metres. An additional drain hose and joining piece is available from your local Service Force Centre. The joining piece must have an internal diameter of 18mm.

Important

Before connecting up the machine to new pipework or to pipework that has not been used for some time, run off a reasonable amount of water to flush out any debris that may have collected in the pipes.

Levelling

Level the washer-dryer by raising or lowering the feet. The feet may be tight to adjust as they incorporate a self locking nut, but the machine **MUST** be level and stable (check diagonally).

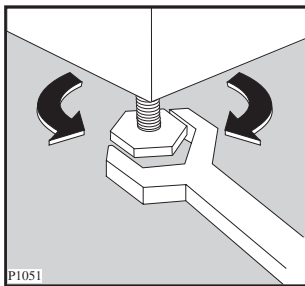

Any necessary adjustment can be made with a spanner. Accurate levelling prevents vibration, noise and displacement of the machine during operation.

Some vibration is inevitable, especially if mounted on a wooden floor.

Sprung wooden floors are particularly susceptible to vibration. For advice, consult a builder. If possible, always place the machine on a solid floor.

Special conditions

If the floor is carpeted or covered with crumbly or soft material, insert a rigid support base under the feet to prevent noise, vibration or displacement. The base should protrude a few centimetres beyond the edges of the machine.



Warning

The machine should **NOT** be placed on deep pile carpeting.

Note

Please ensure that when the appliance is installed it is easily accessible for the engineer in the event of a breakdown.

In the interest of the environment

Washer-dryers and dishwashers should be connected to the FOUL drainage system, the water will then be taken to a sewage works for treatment before being discharged safely into a river.

It is essential that these appliances are not connected to the surface water drainage system as this water is discharged directly into a river or stream and may cause pollution.

If you require any further advice please contact your local water authority.

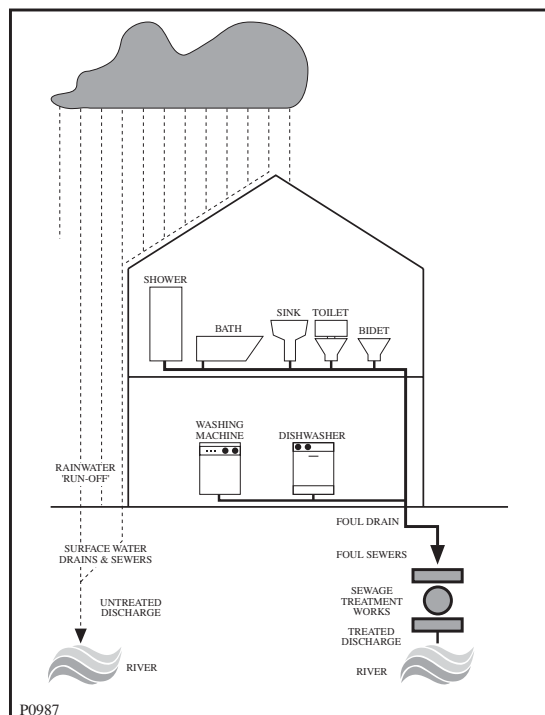

Electrical connection

Any electrical work required to install this appliance should be carried out by a qualified electrician or competent person.

WARNING: THIS APPLIANCE MUST BE EARTHED.

! The manufacturer declines any liability should this safety measure not be observed.

Before switching on, make sure the electricity supply voltage is the same as that indicated on the appliance's rating plate. The rating plate is located at the top of the rim of the open door.

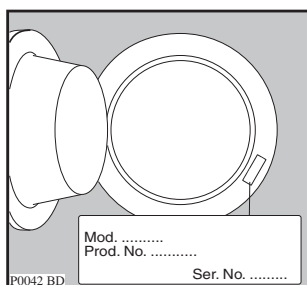

The appliance is supplied with a 13amp plug fitted. In the event of having to change the fuse in the plug supplied, a 13amp ASTA approved (BS1363/A) fuse must be used.

Should the plug need to be replaced for any reason, proceed as described below.

The wires in the mains lead are coloured in accordance with the following code:

Green and Yellow	- Earth
Blue	- Neutral
Brown	- Live

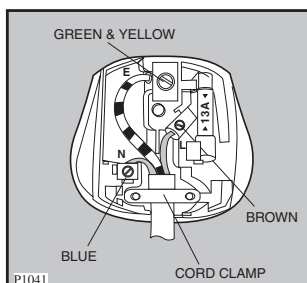

The wire coloured green and yellow must be connected to the terminal marked with the letter «E» or by the earth symbol \perp or coloured green and yellow.

The wire coloured blue must be connected to the terminal «N» or coloured black.

The wire coloured brown must be connected to the terminal marked «L» or coloured red.

Upon completion there must be no cut, or stray strands of wire present and the cord clamp must be secure over the outer sheath.

WARNING:

! A cut off plug inserted into a 13 amp socket is a serious safety (shock) hazard. Ensure that the cut off plug is disposed of safely.

Should the appliance power supply cable need to be replaced, this must be carried out by our Service Force Centre.

Note

When the appliance is installed the power supply cable must be accessible.

Permanent connection

In the case of permanent connection it is necessary that you install a double pole switch between the appliance and the electricity supply (mains), with a minimum gap of 3mm between the switch contacts and of a type suitable for the required load in compliance with the current electrical regulations.

The switch must not break the yellow and green earth cable at any point.

Building-in

This appliance has been designed to be built into the kitchen furniture. The recess should have the dimensions shown in picture A.

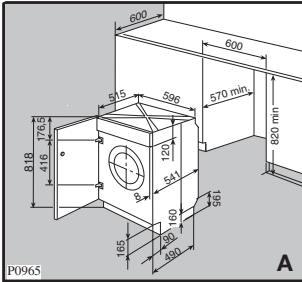

When installing the appliance into the kitchen furniture ensure, if possible, the hoses are placed in either of the two recesses on the back of the appliance. This will help to prevent the hoses from becoming kinked or trapped. Picture AB.

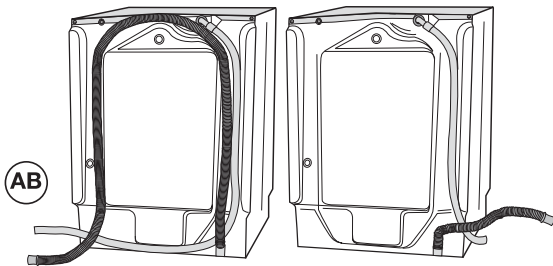

Preparation and assembly of the door

The machine is originally pre-arranged for the assembly of a door opening from right to left.

In this case it is sufficient to screw in the hinges (1) and the counter-magnet (6) provided with the appliance, at the right level (Fig. B).

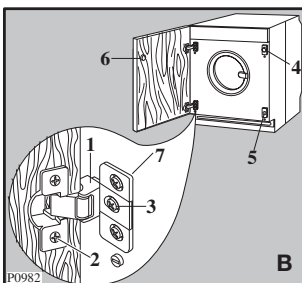

a) Door

The dimensions of the door should be:

- width 595-598 mm
- thickness 16-22 mm

The height (C-Fig. C) depends on the height of the adjacent furniture's base.

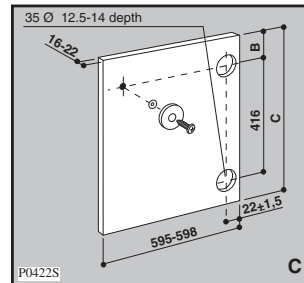

b) Hinges

To mount the hinges it is necessary to drill two holes (dia. 35 mm, depth 12.5-14 mm depending on the depth of door furniture) on the inner side of the door. The distance between the holes hobs fixing centres must be 416 mm.

The distance (B) from upper edge of the door to the centre of the hole depends on the adjacent furniture's dimensions.

The required dimensions are given in the picture C. The hinges will be fixed to the door by means of screws for wood (2-Fig. B) supplied with the appliance.

c) Mounting the door

Fix the hinges (1) to the machine by means of the M5x15 screws (3-Fig. B). The hinges can be adjusted to compensate for possible uneven thickness of the door. To align the door perfectly it is necessary to loosen the screw (3-Fig. B), adjust the door and tighten the screw again.

d) Counter-magnet (6)

The appliance is pre-arranged for a magnetic closure of the door. To enable a correct operation of this device, it is necessary to screw the counter-magnet (6) (steel disk + rubber ring) into the inner side of the door.

Its position must correspond to the magnet (4) on the appliance (see picture D).

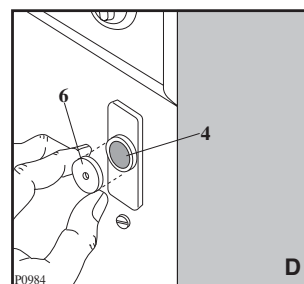

If the door has to be opened from left to right, invert the position of the plates (7), the magnet (4) and the plate (5) (Fig. B and E). Mount the counter magnet (6) and the hinges (1) as previously described.

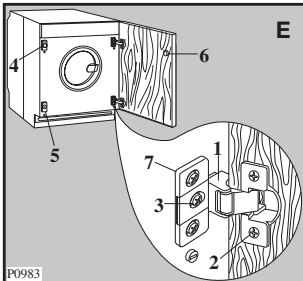

Recommendations regarding the construction and fitting of a base when the installation requires an integrated appliance to be raised

Where the appliance has been raised by mounting onto a wooden base provided by the installer. The material used to construct the base should have a non slip surface, be water repellent and if possible be one solid piece.

If it is not possible to use one solid piece, due to the additional height required, ensure that any additional strips of timber are glued and screwed to the underside of the base (see Fig. F).

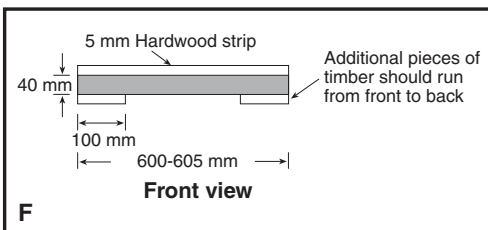

Drill four fixing holes see Fig. G

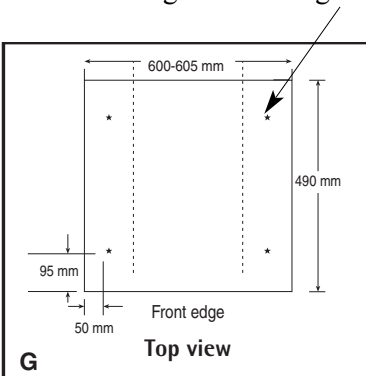

Position the base into the recess with its front edge as far forward as the adjoining plinth line will allow.

The reason for placing the base in this position is to allow a small strip of beading to be fitted in front of the appliance feet.

Fix the base firmly to the floor using four appropriate countersunk screws (see Fig. H).

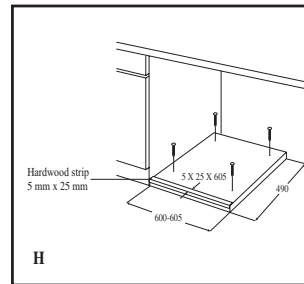

With the appliance installed adjust all four feet ensuring the machine is stable, and a clearance of approximately 5 mm is left between the top of the machine and the underside of the worktop.

A final check for stability should be carried out with the machine on spin with a load, this will identify the need for any further fine adjustment to the feet.

A strip of beading approximately 605 mm W, x 5 mm H, x 25 mm D must be screwed down into the base directly in front of the machine's feet, this will provide additional security.

If required an additional door magnet, part number 1242394-00/3 and disc, part number 1242393-00/5 are available from spare parts.

 **From the Electrolux Group. The world's No. 1 choice.**

The Electrolux Group is the world's largest producer of powered appliances for kitchen, cleaning and outdoor use. More than 55 million Electrolux Group products (such as refrigerators, cookers, washing machines, vacuum cleaners, chain saws and lawn mowers) are sold each year to a value of approx. USD 14 billion in more than 150 countries around the world.

© Electrolux plc 2005

Download from [Www.Somanuals.com](http://www.Somanuals.com). All Manuals Search And Download.

Free Manuals Download Website

<http://myh66.com>

<http://usermanuals.us>

<http://www.somanuals.com>

<http://www.4manuals.cc>

<http://www.manual-lib.com>

<http://www.404manual.com>

<http://www.luxmanual.com>

<http://aubethermostatmanual.com>

Golf course search by state

<http://golfingnear.com>

Email search by domain

<http://emailbydomain.com>

Auto manuals search

<http://auto.somanuals.com>

TV manuals search

<http://tv.somanuals.com>