

**User  
Manual**

**Washing  
Machine**



ZWF180M  
ZWF1000M

## Contents

Safety information	2	Care and cleaning	13
Product description	4	What to do if ...	15
Control Panel	5	Technical data	17
Washing programmes	7-8	Installation	18
Helpful hints and tips	9	Electrical connection	19
First use	10	Environmental concerns	19
Personalisation	10		
Daily use	11		

Subject to change without notice

## Safety information

**Important!** Read carefully and keep for future reference.

- The safety of your appliance complies with the industry standards and with legal requirements on the safety of appliances. However, as manufacturers, we feel it is our duty to provide the following safety notes.
- It is most important that this instruction book should be retained with the appliance for future reference. Should the appliance be sold or transferred to another owner, or should you move house and leave the appliance, always ensure that the book is supplied with the appliance in order that the new owner can get to know the functioning of the appliance and the relevant warnings.
- You **MUST** read them carefully before installing or using the appliance.
- Before first starting up, check the appliance for any damage incurred during transport. Never connect up a damaged appliance. If parts are damaged, contact your supplier.
- If the appliance is delivered in the winter months when there are minus temperatures, store it at room temperature for 24 hours before using for the first time.

### General safety

- It is dangerous to alter the specifications or attempt to modify this product in any way.
- During high temperature wash programmes the doorglass may get hot. Do not touch it!
- Make sure that small children and pets do not climb into the drum. To avoid this, please check into the drum before using.

- Any objects such as coins, safety pins, nails, screws, stones or any other hard, sharp material can cause extensive damage and must not be placed into the machine.
- Only use the advised quantities of fabric softener and detergent. Damage to the fabric can ensue if you over-fill. Refer to the manufacturer's recommendations of quantities.
- Wash small items such as socks, laces, washable belts etc in a washing bag or pillow case as it is possible for such items to slip down between the tub and the inner drum.
- Do not use your washing machine to wash articles with whalebones, material without hems or torn material.
- Always unplug the appliance and turn off the watersupply after use, cleaning and maintenance.
- Under no circumstances should you attempt to repair the machine yourself. Repairs carried out by inexperienced people may cause injury or serious malfunctioning. Contact your local Service Centre. Always insist on genuine spare parts.

### Installation

- This appliance is heavy. Care should be taken when moving it.
- When unpacking the appliance, check that it is not damaged. If in doubt, do not use it and contact the Service Centre.

- All packing and transit bolts must be removed before use. Serious damage can occur to the product and to property if this is not adhered to. See relevant section in the user manual.
- After having installed the appliance, check that it is not standing on the inlet and drain hose and the worktop is not pressing the electrical supply cable against the wall.
- If the machine is situated on a carpeted floor, please adjust the feet in order to allow air to circulate freely under the appliance.
- Always be sure, that there is no water leakage from hoses and their connections after the installation.
- If the appliance is installed in a location subject to frost, please read the “dangers of freezing” chapter.
- Any plumbing work required to install this appliance should be carried out by a qualified plumber or competent person.
- Any electrical work required to install this appliance should be carried out by a qualified electrician or competent person.

## Use

- This appliance is designed for domestic use. It must not be used for purposes other than those for which it was designed.
- Only wash fabrics which are designed to be machine washed. Follow the instructions on each garment label.
- Do not overload the appliance. See the Washing Programme Table.
- Before washing, ensure that all pockets are empty and buttons and zips are fastened. Avoid washing frayed or torn articles and treat stains such as paint, ink, rust, and grass before washing. Underwired bras must NOT be machine washed.
- Garments which have been in contact with volatile petroleum products should not be machine washed.

If volatile cleaning fluids are used, care should be taken to ensure that the fluid is removed from the garment before placing in the machine.

- Never pull the power supply cable to remove the plug from the socket; always take hold of the plug itself.
- Never use the appliance if the power supply cable, the control panel, the working surface or the base are damaged so that the inside of the washing machine is accessible.

## Child safety

- This appliance is not intended for use by person (including children) with reduced physical sensory or mental capabilities or lack of experience and knowledge unless they have been given supervision or instruction concerning use of the appliance by a person responsible for their safety.
- Children should be supervised to ensure that they do not play with the appliance.
- The packaging components (e.g. plastic film, polystyrene) can be dangerous to children - danger of suffocation! - Keep them out of children's reach!
- Keep all detergents in a safe place out of children's reach.
- Make sure that children or pets do not climb into the drum. To prevent children and pets becoming trapped inside the drum this machine incorporates a special feature.

## Product description

- 1 Dispenser detergent drawer
- 2 Control panel
- 3 Drain hose
- 4 Door
- 5 Main plug
- 6 Plinth
- 7 Filter cover
- 8 Adjustable feet

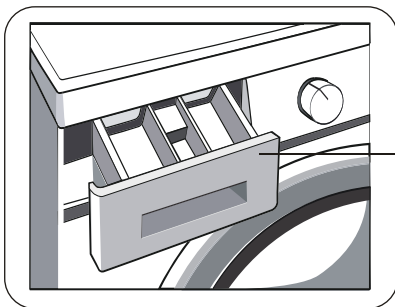
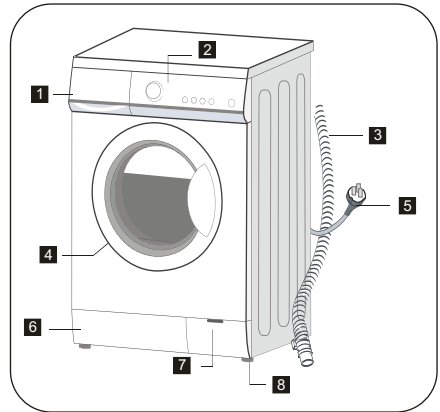

Detergent dispenser drawer

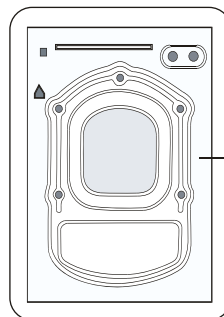

Back cabinet

### Quick Guide

1. Install the washing machine
2. Load the laundry
3. Measure out the detergent
4. Close the door
5. Install the drain and inlet hoses
6. Turn on the water tap
7. Plug the power supply
8. Select the desired programme
9. Press the [start/pause] button

### Accessories

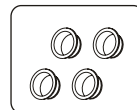

Transport hole plugs

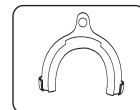

Drain hose support

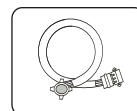

Inlet hose

## Detergent dispenser drawer

**U** Compartment for detergent used for prewash and soak phase or for stain remover used during the stain action phase (if available). The prewash and soak detergent is added at the beginning of the wash programme. The stain remover is added during the stain action phase.

**U** Compartment for powder or liquid detergent used for main wash. If using liquid detergent pour it just before starting the programme.

**⊗** Compartment for liquid additives (fabric softener, starch).

Follow the product manufacturer's recommendations on quantities to use and do not exceed the «MAX» mark in the detergent dispenser drawer. Any fabric softener or starching additives must be poured into the compartment before starting the wash programme.

## Control panel

### ZWF180M

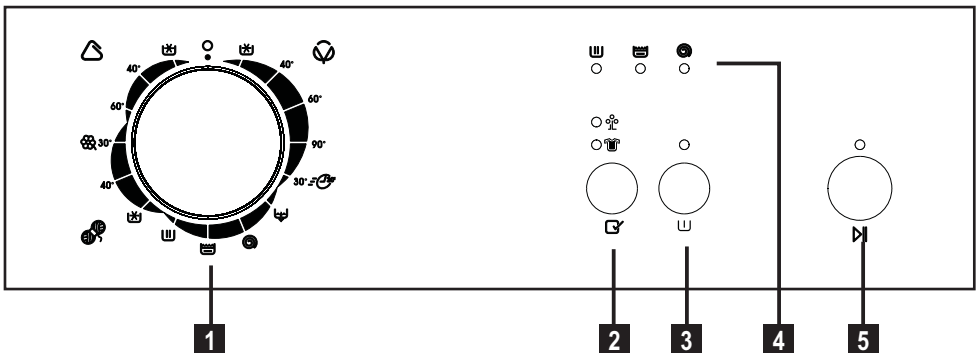



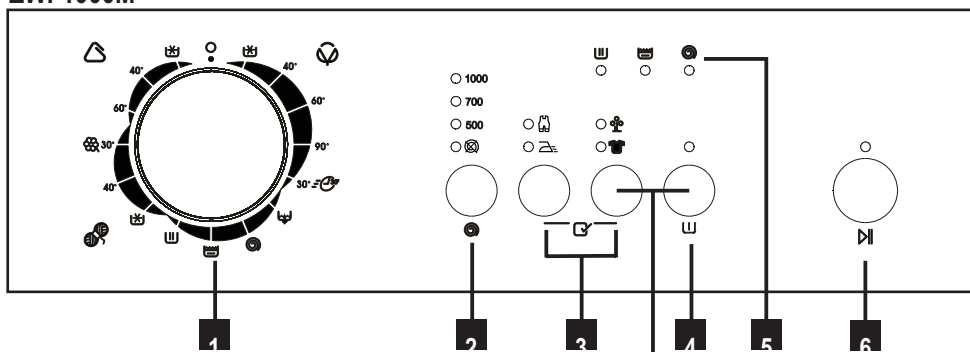

<b>1</b>	<p><b>Programme selector dial</b> Turn the selector dial to select the required washing programme.</p>
<b>2</b>	<p><b>OPTIONS button</b> In order to get better care of your clothes you can select the:</p> <ul style="list-style-type: none"> <li><b>⊗</b> Select the economy for cottons and synthetic items lightly or normally soiled. The washing temperature will be reduced. You can use the Economy option if you want to wash normally soiled laundry and at the same time save energy;</li> <li><b>U</b> Select the Intensive option for heavily soiled laundry. The washing cycle intensity will be increased and the washing time will be prolonged.</li> </ul>
<b>3</b>	<p>Select the PREWASH button option to perform a prewash cycle before the main wash phase. The washing time will be prolonged.</p>

<b>4</b>	<p><b>Washing phases</b> The washing phase running is indicated by the corresponding blinking led.</p>
<b>5</b>	<p>«Start/Pause» button, has the start and pause function. When this button is pressed continuously, this machine is switched between start and pause.</p>

## ZWF1000M











Child Lock

<b>1</b>	<p><b>Programme selector dial</b> So your clothes have a more efficient and clean wash different wash cycles can be selected depending on the users needs.</p>
<b>2</b>	<p><b>SPIN SPEED button</b> By pressing this button you can change the spin speed of the selected programme or to select No Spin option .</p>
<b>3</b>	<p><b>OPTIONS buttons</b> In order to get better care of your clothes you can select the:</p> <ul style="list-style-type: none"> <li> That is to increase the level of rinse water. Baby Care function can make the rinse performance better to protect the baby skin. Except single wash, rinse, drain and spin procedures, the other procedures can select Baby Care function.</li> <li> This means that there is neither drain nor spin after the final rinse. Less Iron function can be used in all procedures except single wash, rinse, drain and spin. To select drain, spin and/or any other washing programmes, first turn the selector dial in position O and then select the required programme.</li> <li> Only for cottons and synthetic items lightly or normally soiled at a temperature of 40°C or higher. The washing time will be prolonged and the washing temperature will be reduced. You can use Economy if you want to wash normally soiled laundry and at the same time save energy.</li> </ul>

<b>4</b>	Select the Prewash option to perform a prewash cycle before the main wash phase. The washing time will be prolonged. Available for cotton programmes.
<b>5</b>	Washing phases The washing phase running is indicated by the corresponding blinking led.
<b>6</b>	«Start/Pause» button, has the start and pause function. When this button is pressed continuously, this machine is switched between start and pause.

## Washing Programmes

Procedure Description	Load kg	Load Type	Detergent Box			Time(Min)	(Max.) Spin Speed (RPM)
			Case I	Case II	Tackifier Case		180M / 1000M
 Cotton Cold	5.0	Cotton		●	○	90	800 / 1000
Cotton 40°C	5.0	Cotton		●	○	80	800 / 1000
Cotton 60°C	5.0	Cotton		●	○	98	800 / 1000
Cotton 90°C	5.0	Cotton		●	○	135	800 / 1000
 Synthetic Cold	2.5	Synthetic		●	○	73	600 / 700
Synthetic 40°C	2.5	Synthetic		●	○	73	600 / 700
Synthetic 60°C	2.5	Synthetic		●	○	90	600 / 700
Delicate 30°C	1.5	Delicate		●	○	60	600 / 700
 Wool Cold	1.5	Wool		●	○	45	600 / 700
Wool 40°C	1.5	Wool		●	○	65	600 / 700
 Quick 30°C	2.5	All		●	○	30	800 / 1000
 Wash	5.0	All		●	○	33	800 / 1000
 Rinse	5.0	All				18	800 / 1000
 Drain	-	-				3	-
 Spin	5.0	All				11	800 / 1000

!Energy test program: Cotton 60 intensive

!Standard Wool program: 40

!●Compulsory

!○Optional

!The parameter in this table are only for user's reference



## Helpful hints and tips

### Sorting out the laundry

Follow the wash code symbols on each garment label and the manufacturer's washing instructions. Sort the laundry as follows: whites, coloureds, synthetics, delicates, woollens.

### Before loading the laundry

Never wash whites and coloureds together. Whites may lose their «whiteness» in the wash. New coloured items may run in the first wash; they should therefore be washed separately the first time. Button up pillowcases, close zip fasteners, hooks and poppers. Tie any belts or long tapes. Remove persistent stains before washing. Rub particularly soiled areas with a special detergent or detergent paste. Treat curtains with special care. Remove hooks or tie them up in a bag or net.

### Removing stains

Stubborn stains may not be removed by just water and detergent. It is therefore advisable to treat them prior to washing.

**Blood:** treat fresh stains with cold water. For dried stains, soak overnight in water with a special detergent then rub in the soap and water.

**Oil based paint:** moisten with benzine stain remover, lay the garment on a soft cloth and dab the stain; treat several times.

**Dried grease stains:** moisten with turpentine, lay the garment on a soft surface and dab the stain with the fingertips and a cotton cloth.

**Rust:** oxalic acid dissolved in hot water or a rust removing product used cold. Be careful with rust stains which are not recent since the cellulose structure will already have been damaged and the fabric tends to hole.

**Mould stains:** treat with bleach, rinse well (whites and fast coloureds only).

**Grass:** soap lightly and treat with bleach (whites and fast coloureds only).

**Ball point pen and glue:** moisten with acetone\*, lay the garment on a soft cloth and dab the stain.

**Lipstick:** moisten with acetone as above, then treat stains with methylated spirits. Treat any residual marks with bleach.

**Red wine:** soak in water and detergent, rinse and treat with acetic or citric acid, then rinse. Treat any residual marks with bleach.

**Ink:** depending on the type of ink, moisten the fabric first with acetone\*, then with acetic acid; treat any residual marks on white fabrics with bleach and then rinse thoroughly.

**Tar stains:** first treat with stain remover, methylated spirits or benzine, then rub with detergent paste.

### Detergents and additives

Good washing results also depend on the choice of detergent and use of the correct quantities to avoid waste and protect the environment.

Although biodegradable, detergents contain substances which, in large quantities, can upset the delicate balance of nature.

The choice of detergent will depend on the type of fabric (delicates, woollens, cottons, etc.), the colour, washing temperature and degree of soiling.

All commonly available washing machine detergents may be used in this appliance:

- powder detergents for all types of fabric
- powder detergents for delicate fabrics (60°C max) and woollens
- liquid detergents, preferably for low temperature wash programmes (60°C max) for all types of fabric, or special for woollens only.

The detergent and any additives must be placed in the appropriate compartments of the dispenser drawer before starting the wash programme.

If using liquid detergents, a programme without prewash must be selected.

Your appliance incorporates a recirculation system which allows an optimal use of the concentrated detergent.

Follow the product manufacturer's recommendations on quantities to use and do not exceed the «MAX» mark in the detergent dispenser drawer.

### Quantity of detergent to be used

The type and quantity of detergent will depend on the type of fabric, load size, degree of soiling and hardness of the water used.

Follow the product manufacturers' instructions on quantities to use.

Use less detergent if:

- you are washing a small load
- the laundry is lightly soiled
- large amounts of foam form during washing.

\* do not use acetone on artificial silk.

## Degrees of water hardness

Water hardness is classified in so-called «degrees» of hardness. Information on hardness of the water in your area can be obtained from the relevant water supply company, or from your local authority.

When the degree of hardness is soft, re-adjust the quantity of the detergent.

## First Use

---

- Ensure that the electrical and water connections comply with the installation instructions.
- Remove any material from the drum.
- Run a cotton cycle at the highest temperature without any laundry in the machine, to remove any manufacturing residue from the drum and tub. Pour 1/2 a measure of detergent into the main wash compartment and start the machine.

## Personalization

---

### Additional buzzer selection

There is an additional selectable buzzer feature. Press the Prewash button (L) for three seconds, there will be a «beep» and any operation on the control panel becomes silent. To restore the buzzer, press the Prewash button (L) for three seconds again. Turning the machine off and then on again will not change the buzzer state.

### Child safety lock (only for model ZWF1000M)

This device permits you to leave the appliance unattended so you do not need to worry that children might be injured by or cause damage to the

appliance. This function remains enabled also when the washing machine is not working.

You can activate it pressing the buttons 3 and 4 for three seconds to activate the safety device .

Now, it will be impossible to change any other programme or option.

## Daily Use

### Load the laundry

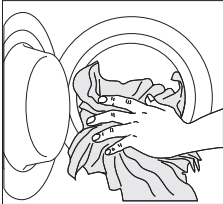

Open the door by carefully pulling the door handle outwards. Place the laundry in the drum, one item at a time, shaking them out as much as possible. Close the door.

### Measure out the detergent and the fabric softener

Pull out the dispenser drawer until it stops. Measure out the amount of detergent required, pour it into the main wash compartment or in the appropriate compartment if the selected programme/option it requires (see more details in «Detergent dispenser drawer»).

If required, pour fabric softener into the compartment marked (the amount used must not exceed the «MAX» mark in the drawer). Close the drawer gently.

### Select the required programme by means of the programme selector dial (1)

Turn the programme selector dial to the required programme.

The selector dial can be turned either clockwise or anticlockwise.

### Turn the selector dial to position **O** to reset the programme or to switch the machine off.

At the end of the programme the selector dial must be turned to position **O**, to switch the machine off.

**Important!** If you turn the programme selector dial to another programme when the machine is working, the machine will not perform the new selected programme.

### Select the spin speed or the Rinse Hold option by pressing button **2** (only for ZWF1000M)

When selecting a programme, the appliance proposes automatically a suggested spin speed for that programme. (See «Washing programmes» for the maximum allowed spin speed).

Press this button repeatedly to change the spin speed, if you want your laundry to be spun at a different speed. The relevant pilot light illuminates.

### Select the available options by pressing button **2** for the model ZWF180M and buttons **3** for model the ZWF1000M

When this button is pressed, the corresponding pilot light illuminates. When it is pressed again, the pilot light goes out.

### Select the Prewash option by pressing button **3** for the model ZWF180M and button **4** for the model ZWF1000M.

When this button is pressed, the corresponding pilot light illuminates. When it is pressed again, the pilot light goes out.

### Start the programme by pressing button **5** for model the ZWF180M and button **6** for the model ZWF1000M

Press this button to start the selected washing programme.

### Altering an option

It is possible to change some options before the programme carries them out.

Before you make any change, you must pause the washing machine by pressing button **5** for ZWF180M or **6** for ZWF1000M.

### Change a running programme

To change a running programme:

- turn the programme selector dial to **O**, select the new programme and press button **5** for ZWF180M or **6** for ZWF1000M to start the new programme;
- press button **5** for ZWF180M or **6** for ZWF1000M to pause the machine, turn the programme selector dial to the new programme and press button **5** or **6** again.

The washing water in the tub will be emptied out.

**⚠ Warning!** For safety reasons you are only able to change the programme before the heating phase has started.

### Interrupting a programme

Press the button **5** for ZWF180M or **6** for ZWF1000M, to interrupt a programme which is running.

Press the button again to restart the programme.

### **Cancelling a programme**

Turn the selector dial to **O** to cancel a programme which is running, and wait few minutes to open the door (This is only possible if there is no water in the tub).

### **At the end of the programme**

The machine stops automatically.

At the end of the programme, the door is released, after few minutes, and can be opened. Turn the programme selector dial to **O** to switch the machine off.

Remove the laundry from the drum and carefully check that the drum is empty. If you do not intend to carry out another wash, close the water tap. Leave the door open to prevent the formation of mildew and unpleasant smells.

### **Stand-By:**

Once the programme has finished after a few minutes the energy saving system will be enabled.

By pressing any button the appliance will come out of the energy saving status.

## Care and cleaning

**⚠ Warning!** You must **DISCONNECT** the appliance from the electricity supply, before you can carry out any cleaning or maintenance work.

### Descaling

The water we use normally contains lime. It is a good idea to periodically use a water softening powder in the machine.

Do this separately from any laundry washing, and according to the softening powder manufacturer's instructions.

This will help to prevent the formation of lime deposits.

### External cleaning

Clean the exterior cabinet of the appliance with soap and water only, and then dry thoroughly.

### Cleaning the dispenser drawer

The washing powder and additive dispenser drawer should be cleaned regularly.

1 Press

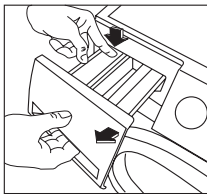

2 Pull out at the same time

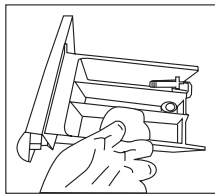

3 Clean

Flush it out under a tap, to remove any traces of accumulated powder.

### Cleaning the drawer recess

Have

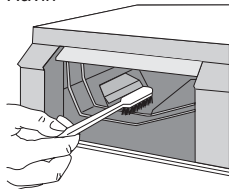

run the rinse programme drum.

g removed the drawer, use a small brush to clean the recess ensuring that all washing powder residue is removed from the upper and lower part of the recess.

Replace the drawer and

without any clothes in the

### Cleaning the pump

#### Important!

According to the soil level within the cycles and the frequency of the cycles, you have to inspect and clean the filter regularly.

The pump should be inspected if:

- the machine does not empty and/or spin;
- the machine makes an unusual noise during draining due to objects such as safety pins, coins etc. blocking the pump.

Proceed as follows:

- 1 disconnect the appliance;
- 2 if necessary wait until the water has cooled down.

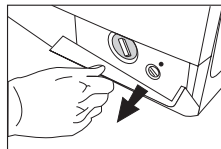

- 3 Open the pump door. Place a container close to the pump to collect any spillage.

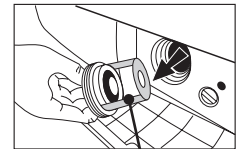
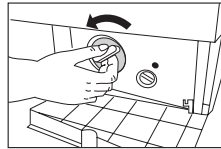

Pump cover

- 4 Gradually unscrew the pump cover to drain out the water.
- 5 When no more water comes out, unscrew the pump cover and remove it. Always keep a towel nearby to dry up spillage of water when removing the cover.
- 6 Remove any objects from the pump impeller by rotating it.
- 7 Screw the pump cover fully in.
- 8 Close the pump door.

#### ⚠ Warning!

When the appliance is in use and depending on the programme selected there can be hot water in the pump. Never remove the pump cover during a wash cycle, always wait until the appliance has finished the cycle, and is empty. When replacing the cover, ensure it is securely retightened so as to stop leaks and young children being able to remove it.

If you wash rugs, it is compulsory to inspect and clean the filter.

### Cleaning the water inlet filters

#### Important!

If the appliance doesn't fill, takes too long to fill with water, the start button blinks yellow or the display (if available) shows the relevant alarm (see chapter «What to do if...» for more details), check if the water inlet filters are blocked.

To clean the water inlet filters:

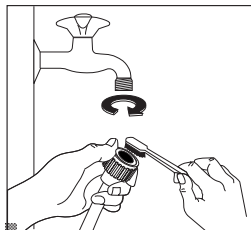

- Turn off the water tap.
- Unscrew the hose from the tap.
- Clean the filter in the hose with a stiff brush.

• Screw the hose back onto the tap. Make sure the connection is tight.

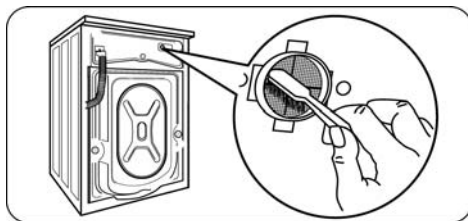

- Unscrew the hose from the machine. Keep a rag nearby because some water may flow.
- Clean the filter in the valve with a stiff brush or with the piece of cloth.

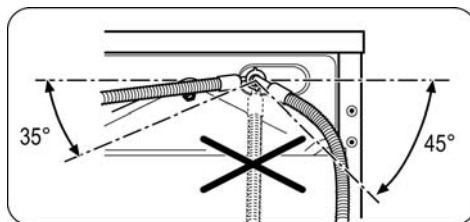

- Screw the hose back to the machine and make sure the connection is tight.
- Turn on the water tap.

### Frost precaution or emergency emptied out

If the machine is exposed to temperatures below 0°C or if the water is not discharged, proceed as follows.

- 1 Pull out the plug from the power socket.
- 2 Turn off the water tap.
- 3 Unscrew the inlet hose.
- 4 Place a bowl on the floor and place the end of the inlet and drain hoses into it. The water should drain by gravity into the bowl.
- 5 Select and run a draining programme.
- 6 Clean the pump if necessary as previously described.
- 7 Screw the water inlet hose back on.
- 8 When you intend to start the machine up again, make sure that the room temperature is above 0°C.

## What to do if.....

Certain problems are due to lack of simple maintenance or oversights, which can be solved easily without calling out an engineer.

Before contacting your local Service Centre, please carry out the checks listed below.

Malfunction	Possible Cause / Solution
<b>The washing machine does not work</b>	<ul style="list-style-type: none"> <li>• Close the washing machine's door.</li> <li>• Press the Start/Pause button.</li> </ul>
<b>Water leakage</b>	<ul style="list-style-type: none"> <li>• Correctly connect the inlet water pipe.</li> </ul>
<b>The spin of the clothes is abnormal</b>	<ul style="list-style-type: none"> <li>• Reload and distribute the laundry evenly in the drum.</li> </ul>
<b>There is a peculiar smell in the washing machine</b>	<ul style="list-style-type: none"> <li>• Run a washing cycle without any clothes at maximum temperature using a biological powder.</li> </ul>
<b>No water is visible in the drum</b>	<ul style="list-style-type: none"> <li>• No fault-water is under the visible area.</li> </ul>
<b>There is the remaining water in the softener's box</b>	<ul style="list-style-type: none"> <li>• No fault the effect of the softener will not be affected. Empty before next use.</li> </ul>
<b>The remaining detergent is left on the clothes</b>	<ul style="list-style-type: none"> <li>• The water-fast component of the non-phosphorus detergent will be left on the clothes to form into spot.</li> <li>• Please select «Rinse&amp;Spin» programme. or brush away the fleck after the clothes is dried.</li> </ul>
<b>The washing machine does not fill</b>	<ul style="list-style-type: none"> <li>• Turn on the water tap.</li> <li>• Check the selection of the procedure.</li> <li>• Check if the water pressure is sufficient.</li> <li>• Reconnect the water inlet pipe.</li> <li>• Close the washing machine's door.</li> <li>• Check if the inlet water pipe is bent or blocked.</li> </ul>
<b>The washing machine fills and drains at the same time.</b>	<ul style="list-style-type: none"> <li>• Make sure the end of the drainage pipe is higher than the water level inside the machine .</li> <li>• Please delete or amend this sentence we would not recommend for anyone to seal their drainage pipe.</li> </ul>
<b>The washing machine does not drain</b>	<ul style="list-style-type: none"> <li>• Check if the drainage pumps is blocked.</li> <li>• Check if the drainage pipe is bent or blocked.</li> <li>• Check the height of the drainage nozzle, make sure it is 0.6-1 meter high from the bottom of the washing machine.</li> </ul>
<b>Vibration of the washing machine</b>	<ul style="list-style-type: none"> <li>• Level the washing machine.</li> <li>• Fasten the footing.</li> <li>• Check if all the delivery bolts have all been removed.</li> </ul>

Malfunction	Possible Cause / Solution
<b>Foam spills from the detergent drawer</b>	<ul style="list-style-type: none"> <li>• Check if the amount of detergent is excessive, if it is the specialized detergent for the drum washing machine.</li> <li>• Dip one scoop of the softener mixed with 1/2 liter of water to the detergent box II.</li> <li>• Reduce the amount of detergent used next time.</li> </ul>
<b>The machine stops when the procedure has not been finished</b>	<ul style="list-style-type: none"> <li>• Power failure or water cut.</li> </ul>
<b>The drainage pump is noisy during operation after the water has been drained.</b>	<ul style="list-style-type: none"> <li>• The water inside the inner barrel has been drained but there is still a small amount of water in the drainage pump and pipe. The drainage pump continuously work and takes in the air, then there will be noise which is normal situation.</li> </ul>
<b>The machine stops for some time during the wash procedure.</b>	<ul style="list-style-type: none"> <li>• The washing machine adds water automatically.</li> <li>• There is too much foam in the drain tube, the foam is being drained.</li> </ul>



## Alarm codes

⚠ If the washing machine cannot work normally, a alarm code will appear on the display. Please carry out the following checks.

Alarm Code	Status of Corresponding Indicators			Description	Reason	Solution
	Wash	Rinse	Spin			
	Off	Off	Flash	Door lock problem	Door is not closed properly. Please call the service number if you experience any problems.	Restart after the door is closed
	Off	Flash	Off	Water fill problem when washing (water fill time exceeds 5 minutes)	Tap is not opened or water flows too slowly. Inlet valve filter is blocked. Inlet pipe is twisted. If water is not supplied Please call the service number if you experience any problems.	Open the tap or wait till the water supply becomes normal. Check inlet valve filter. Straighten the water pipe Check the other taps in the room.
	Off	Flash	Flash	Drain problem while washing (drain time exceeds 7 minutes)	Outlet hose is blocked or twisted Drain pump is blocked Please call the service number if you experience any problems.	Wash and straighten outlet hose. Wash drain pump filter
	Off	On	Flash	Excessive Foam	Excessive detergent has been used. Wrong detergent used. Detergent used improperly. Please call the service number if you experience any problems.	Reduce detergent quantity Use the detergents suitable for washing machine

Please call up the service line if there is any other problem.

If you are unable to identify or solve the problem, contact our service centre. Before telephoning, make a note of the product number, model, serial number and purchase date of your machine. The Service Centre will require this information.

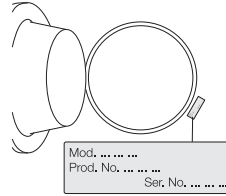

## Technical data

Parameter \ Model	ZWF180M	ZWF1000M
Power Supply	220V-240V~/50Hz	220V-240V~/50Hz
Dimension (W*D*H)	595*520*850mm	595*520*850mm
Weight	60kg	60kg
Maximum Power	2100W	2100W
Washing Capacity	5.0kg	5.0kg
Rated Current	10A	10A
Standard Water Pressure	0.05MPa ~ 1MPa	0.05MPa ~ 1MPa
Spin speed	800	No Spin-500/ 700/1000

# Installation

## Unpacking

All transit bolts and packing must be removed before using the appliance.

You are advised to keep all transit devices so that they can be refitted if the machine ever has to be transported again.

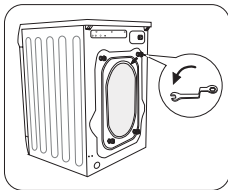

Unscrew the four bolts using a spanner. Slide out the relevant plastic spacers.

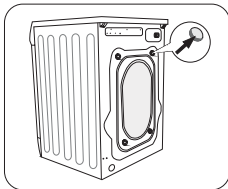

Fill the holes with the corresponding plastic plug caps supplied in the bag containing the instruction booklet.

## Positioning

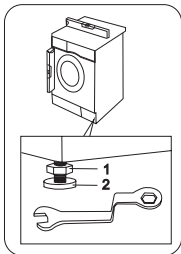

Install the machine on a flat hard floor. Make sure that air circulation around the machine is not impeded by carpets, rugs etc. Check that the machine does not touch the wall or other kitchen units. Level the washing machine by raising or lowering the feet. The feet may be tight to adjust as they incorporate a self locking nut,

but the machine **MUST** be level and stable. Any necessary adjustment can be made with a spanner.

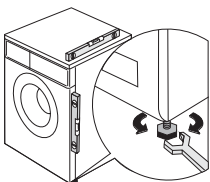

If necessary, check the setting with a spirit level.

Accurate levelling prevents vibration, noise and displacement of the machine during operation. Never place cardboard, wood or similar materials under the machine to compensate for any unevenness in the floor.

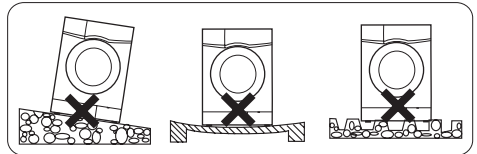

## Water inlet

**⚠ Caution!** This appliance must be connected to a cold water supply.

**⚠ Caution!** Before connecting up the appliance to new pipework or to pipework that has not been used for some time, run off a reasonable amount of water to flush out any debris that may have collected

**⚠ Caution!** Do not use the hose from your previous appliance to connect to water supply.

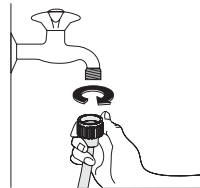

Connect the hose to a tap with a 3/4" thread.

Always use the hose supplied with the appliance.

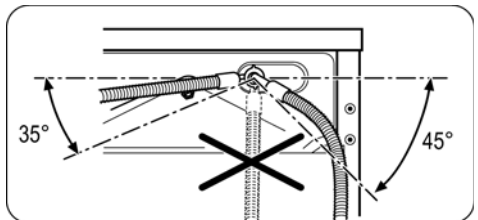

The other end of the inlet hose which connects to the appliance can be turned as showed in the picture. Do not place the inlet hose downwards. Angle the hose to the left or right depending on the position of your water tap. Set the hose correctly by loosening the ring nut. After positioning the inlet hose, be sure to tighten the ring nut again to prevent leaks.

**Caution!** The inlet hose must not be lengthened. If it is too short and you do not wish to move the tap, you will have to purchase a new, longer hose specially designed for this type of use.

## Water drainage

The end of the drain hose can be positioned in three ways:

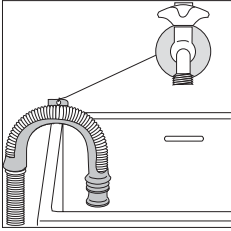

**Hooked over the edge of a sink** using the plastic hose guide supplied with the machine.

In this case, make sure the end cannot come unhooked when the machine is emptying.

This could be done by tying it to the tap with a piece of string or attaching it to the wall.

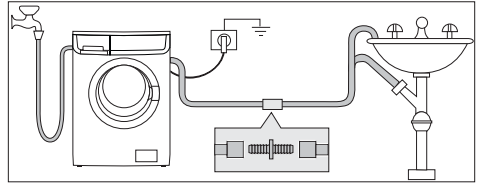

**In a sink drain pipe branch.**

This branch must be above the trap so that the bend is at least 60 cm above the ground.

**⚠ Caution!** This must be secured with a clip.

**Directly into a drain pipe** at a height of not less than 60 cm and not more than 90 cm. The end of the drain hose must always be ventilated, i.e. the inside diameter of the drain pipe must be larger than the outside diameter of the drain hose.

## Electrical connection

Information on the electrical connection is given on the rating plate on the inner edge of the appliance door. Check that your domestic electrical installation can take the maximum load required, also taking into account any other appliances in use.

**⚠ Caution!** Connect the machine to an earthed socket.

**⚠ Caution!** The manufacturer does not accept any responsibility for damage or injury through failure to comply with the above safety precaution.

**⚠ Caution!** Should the appliance power supply cable need to be replaced, this **MUST** be carried out by a Service Centre.

**⚠** The power supply cable must be easily accessible after installing the machine.

## Environment concerns



The symbol on the product or on its packaging indicates that this product may not be treated as household waste. Instead it should be taken to the appropriate collection point for the recycling of electrical and electronic equipment. By ensuring this product is disposed of correctly, you will help prevent potential negative consequences for the environment and human health, which could otherwise be caused by inappropriate waste handling of this product.

For more detailed information about recycling of this product, please contact your local council, your household waste disposal service or the shop where you purchased the product.

### Packaging materials

The materials marked with the symbol are recyclable.

>PE<=polyethylene

>PS<=polystyrene

>PP<=polypropylene

>PAP<=paper







[www.zanussi.co.uk](http://www.zanussi.co.uk)



## Free Manuals Download Website

<http://myh66.com>

<http://usermanuals.us>

<http://www.somanuals.com>

<http://www.4manuals.cc>

<http://www.manual-lib.com>

<http://www.404manual.com>

<http://www.luxmanual.com>

<http://aubethermostatmanual.com>

Golf course search by state

<http://golfingnear.com>

Email search by domain

<http://emailbydomain.com>

Auto manuals search

<http://auto.somanuals.com>

TV manuals search

<http://tv.somanuals.com>