

INSTRUCTION BOOKLET

**READ AND KEEP
THESE INSTRUCTIONS**

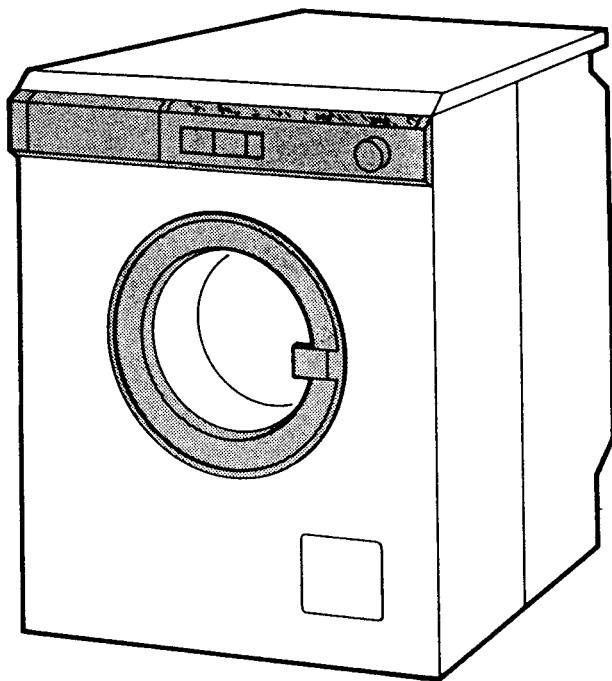

**WASHING MACHINE
FJ 831**

ZANUSSI

INDEX

Page 2	Technical specifications
Page 3	Warnings
Page 4	The control panel
Page 6	Your machine
Page 7	Installation instructions
Page 11	Use of controls
Page 14-15	The washing programmes
Page 16	Use of detergent and additives
Page 18	Washing 4 kg of white cotton at 95°C
Page 20	Washing 2 kg of delicate synthetic fabrics at 40°C
Page 22	Washing hints
Page 23	Maintenance
Page 24	Cleaning the filter
Page 25	Servicing
Page 32	Zanussi guarantee conditions

TECHNICAL SPECIFICATIONS

DIMENSIONS	Width	60 cm (23.6")
	Height	85 cm (33.5")
	Depth	57 cm (22.4")
ELECTRICAL CONNECTION	Voltage	220/240V - 50Hz
	Maximum power absorbed	2600 W (13A)
WATER PRESSURE	Minimum (hot)	5 psi
	Minimum (cold)	7 psi
	Maximum	110 psi
MAXIMUM RECOMMENDED LOAD	Cotton, linen	4.5 kg (10 lb)
	Synthetics, delicate fabrics	2 kg (4.5 lb)
	Wool	1 kg (2.2 lb)
SPIN SPEED	Maximum	800 r.p.m.

This appliance conforms to the E.E.C. directive No. 87/308 of 2/6/87 regarding the suppression of radio interference.

WARNINGS

It is most important that this instruction book should be retained with the appliance for future reference. Should the appliance be sold or transferred to another owner, or should you move house and leave the appliance, always ensure that the book is supplied with the appliance in order that the new owner can be acquainted with the functioning of the appliance and the relevant warnings.

These warnings are provided in the interest of safety. You must read them carefully before installing or using the appliance.

- ▲ This appliance is designed to be operated by adults. Children should not be allowed to tamper with the controls or play with the product.
- ▲ It is dangerous to alter the specifications or attempt to modify this product in any way.
- ▲ Any electrical work required to install this appliance should be carried out by a qualified electrician or competent person.
- ▲ Any plumbing work required to install this appliance should be carried out by a qualified plumber or competent person.
- ▲ This product should be serviced by an authorized Zanussi Service Centre, and only genuine Zanussi spare parts should be used.
- ▲ Care must be taken to ensure that the appliance does not stand on the electrical supply cable.
- ▲ Always unplug the appliance and turn off the water after use.
- ▲ Do not overload the appliance. See relevant section in instruction book.
- ▲ Always look through the glass door to check if water has drained before opening the door. If water is present do not open door before draining the water. If in doubt, refer to your instruction book.
- ▲ This appliance is heavy. Care should be taken when moving it.
- ▲ All packing and transit bolts must be removed before use. Serious damage can occur to the product and to property if this is not adhered to. See relevant section in instructions.
- ▲ The glass door becomes very hot during the washing cycle. Keep children away from the vicinity of the appliance whilst it is in operation.
- ▲ Leave the porthole door slightly ajar between washes to preserve the door seal.
- ▲ Only wash fabrics which are designed to be machine washed. If in doubt, consult the manufacturer of that item.
- ▲ Before washing, ensure that all pockets are empty and buttons and zips are fastened. Avoid washing frayed or torn articles and treat stains such as paint, ink, rust, and grass before washing. Underwired bras must not be machine washed.
- ▲ Any objects such as coins, safety pins, nails, screws, stones or any other hard, sharp material can cause extensive damage and must not be placed into the appliance.
- ▲ Before selecting a programme or changing an ongoing programme the machine must be switched off by depressing the START/STOP push-button.
- ▲ Garments which have been in contact with volatile petroleum products should not be machine washed. If volatile cleaning fluids are used, care should be taken to ensure that the fluid is removed from the garment before placing in the machine.
- ▲ Wash small items such as socks, laces, washable belts etc in a washing bag or pillow case as it is possible for such items to slip down between the tub and the inner drum.
- ▲ Only use the advised quantities of fabric softener. Damage to the fabric can ensue if you over-fill. Refer to the manufacturer's recommendations of quantities.
- ▲ As some duvets and eiderdowns should be washed/dried in large commercial machines because of their bulk, please check with the manufacturer of the item before washing in a domestic machine, even if the dry weight of the item is within the limit advised.
- ▲ Pets have been known to climb into washing machines. Please check your drum before use.
- ▲ If the machine is situated on a carpeted floor, please adjust the feet to ensure that air can circulate freely.
- ▲ Under no circumstances should you attempt to repair the machine yourself. Repairs carried out by inexperienced persons may cause injury or more serious malfunctioning. Contact your local Zanussi Service Centre. Always insist on genuine Zanussi spare parts.





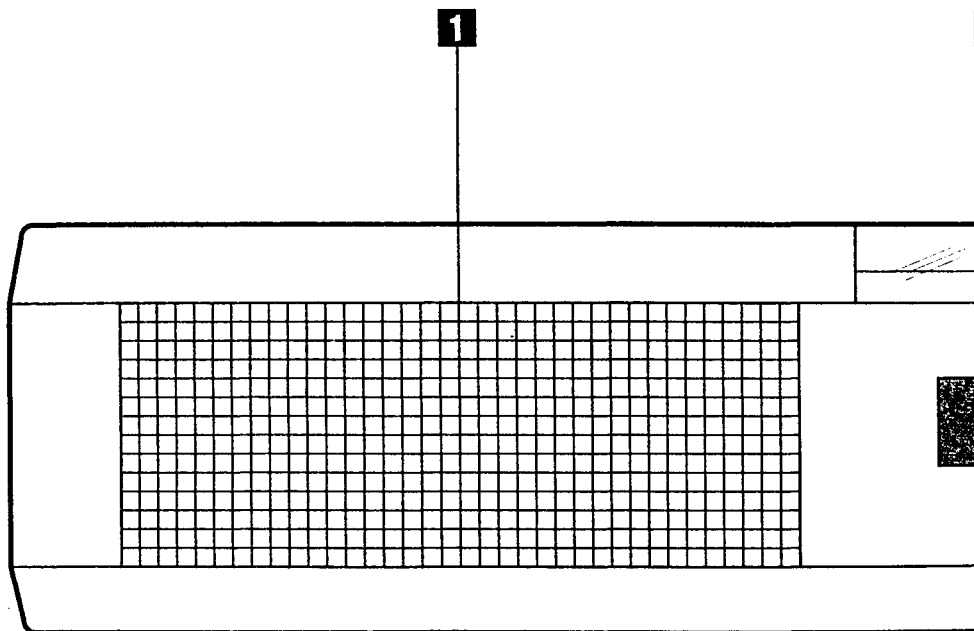





THE CONTROL PANEL

Keep this page open while reading the booklet



SYMBOLS

Symbols provided on the control panel have the following meaning:

- | | | |
|--|--|--|
|  Pilot light |  Prewash compartment |  Wash |
|  Start/Stop button |  Wash compartment |  Rinses |
|  Rinse Hold |  Softener compartment |  Spin |
|  Super economy | |  Drain |

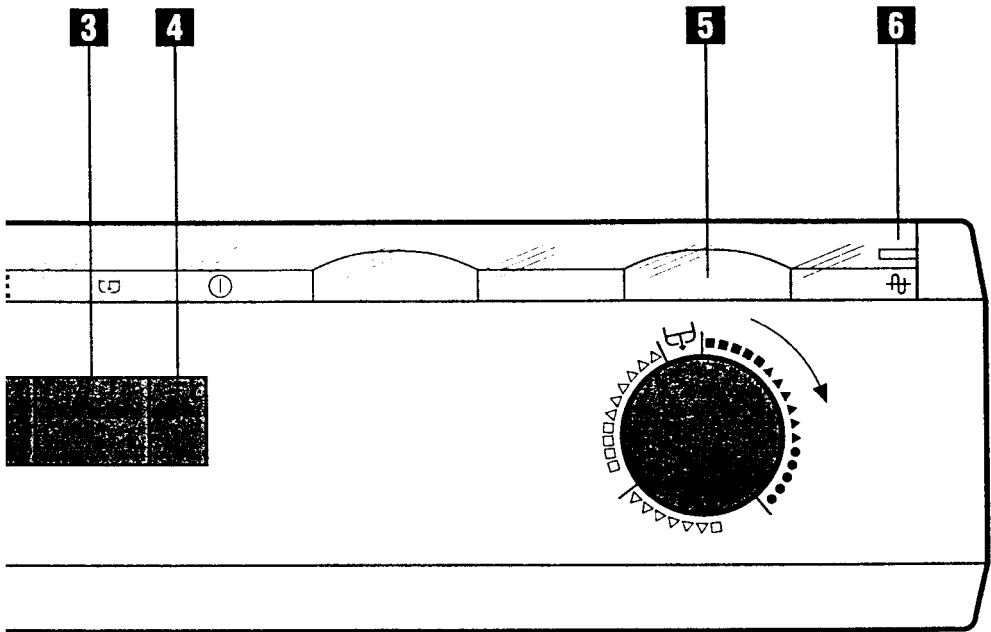

- 1** Programme chart
- 2** «Super economy» push button
- 3** «Rinse Hold» push button
- 4** Start/Stop button
- 5** Programme control
- 6** Pilot light

YOUR MACHINE

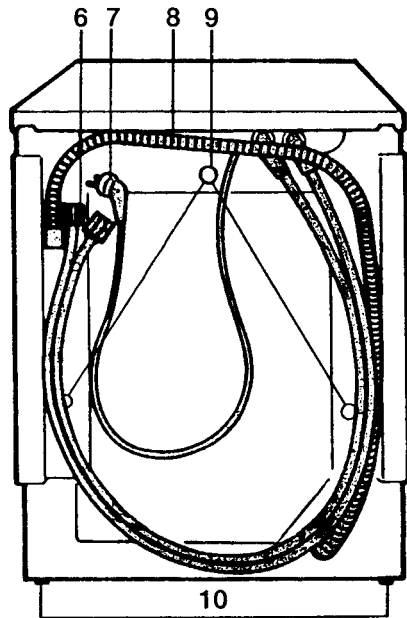
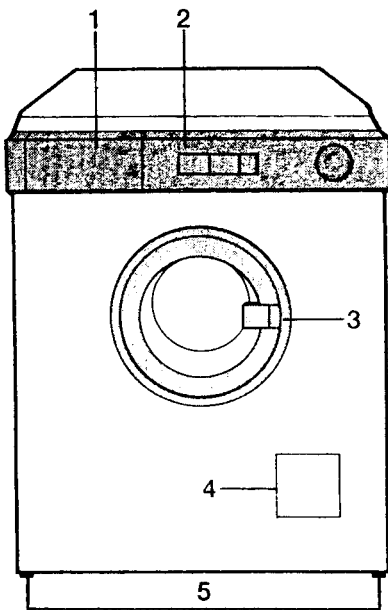

- 1 Washing powder dispenser drawer
- 2 Control panel
- 3 Door catch
- 4 Drain Filter
- 5 Adjustable feet

- 6 Water inlet hoses
- 7 Mains lead with plug
- 8 Drain hose
- 9 Transport safety screws
- 10 Rollers

INSTALLATION INSTRUCTIONS

CAUTION

Before starting the machine up, the packing must be removed as follows.

NOTE

You are advised to keep all the packing for re-use in case the machine has to be transported again.

1

Using a spanner unscrew and remove the rear right screw.

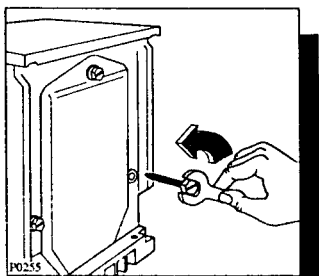

2

Lay the machine on its back making sure that the hoses are not squashed.

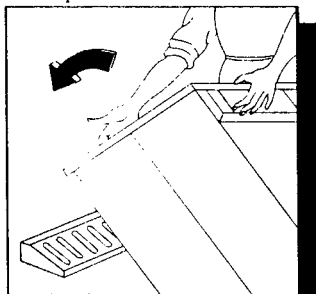

3

Remove the polystyrene block from the bottom of the machine.

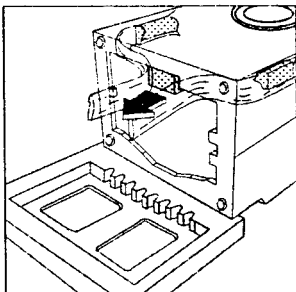

4

Carefully slide out the right polythene bag, removing it towards the centre of the machine.

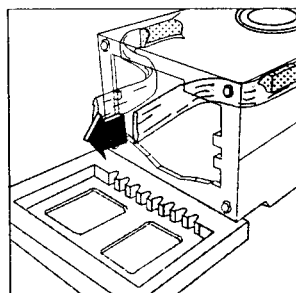

5

Repeat the operation for the left polythene bag, removing it towards the centre of the machine.

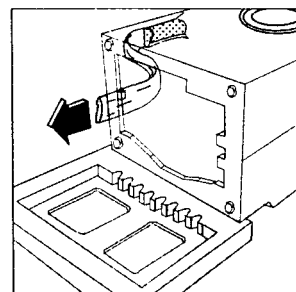

6

Remove the polystyrene base, set the machine upright and unscrew the two remaining rear screws.

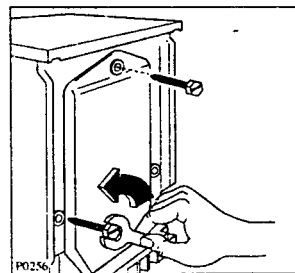

7

Slide out the 3 plastic pins.

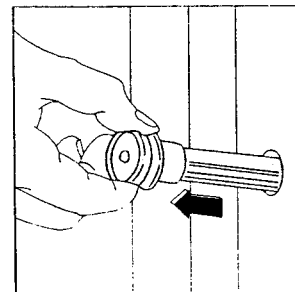

8

Plug the 3 holes with the 3 plastic plugs which you can find on the back of the machine.

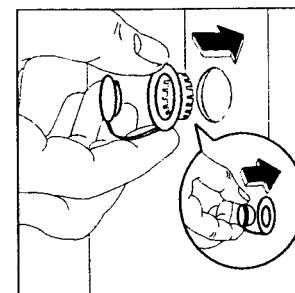

INSTALLATION INSTRUCTIONS

9

Your new Zanussi washing machine has been designed to be permanently plumbed in to your home's water supply and drainage system. However, if this is not possible, it may be connected to suitable existing taps, with the drain hose discharging into a sink.

The appliance has two inlet valves, hot and cold, with female 3/4" BSP thread connectors. If this connection size is not compatible with the plumbing of the existing installation, a variety of connectors are available from good hardware stores and plumbers merchants to suit most domestic plumbing. Any alterations to your existing plumbing must be carried out by a competent person, or qualified plumber.

10

The inlets on the back of the appliance are colour coded, blue for cold, red for hot.

Before connecting the hoses be sure to fit the mesh filters supplied as per diagram.

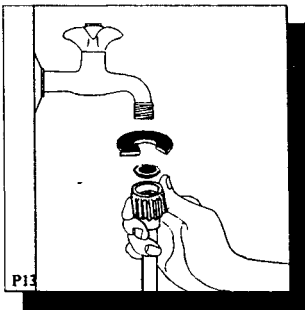

If only a cold water supply is available, connect the two hoses to a cold water outlet by means of a 'Y' connection piece.

Installation should comply with local water authority and building regulations' requirements.

The appliance must be given a separate cold water supply and not be connected to a mixer tap, a single outlet water heater or a booster pump. A minimum water pressure of 7 psi is required for safe operation of the appliance.

If you cannot make the cold water connection direct from the rising mains, you may be able to operate the appliance from your cold water storage system.

There should be a minimum distance of 5.02 m (16½ ft) between the appliance's inlet and the bottom of the tank.

There will be sufficient pressure for the hot water supply from the hot water cylinder if the height between the appliance's inlet and the bottom of the cold water storage cistern (not between the appliance and hot water cylinder) is at least 2.74 m (9 ft).

11

Set the hose correctly by loosening the ring nuts. After positioning the inlet hose, be sure to tighten the ring nut again to prevent leaks.

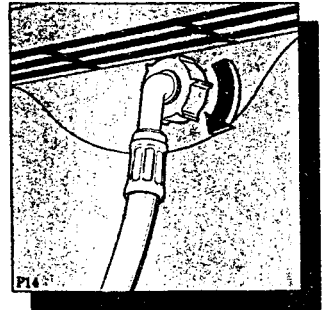

INSTALLATION INSTRUCTIONS

12

If you intend the drain hose from the machine to empty into a sink, make sure that the sink is empty and that the plug hole is not blocked.

If the machine is permanently plumbed in, hook the end of the drain hose into a standpipe installed for the purpose.

The standpipe must have an internal diameter of at least 30 mm (1 1/2 in), in order that there is an air gap between the drain hose and standpipe. Make sure, that it is designed in such a way, that the end of the drain hose cannot be covered with water.

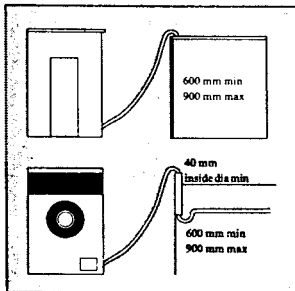

Important: Before connecting up the machine to new pipework or to pipework that has not been used for some time, run off a reasonable amount of water to flush out any debris that may have collected in the pipes.

Whether discharging into a sink or a standpipe check that the end of the drain hose is neither too high nor too low. The top of the curve in the hose's end should be no more than 90 cm (35.4") and no less than 60 cm (23.6") above floor level.

13

ELECTRICAL CONNECTION

WARNING:
THIS APPLIANCE
MUST BE EARTHED

The manufacturer declines any liability should this safety measure not be observed.

If the plug that is fitted to your appliance is not suitable for your socket outlet, it must be cut off and the appropriate plug fitted.

Remove the fuse from the cut off plug. The plug should then be disposed of to prevent the hazard of electric shocks in case it should be plugged into a 13 Amp socket in another part of your home.

Important

The wires in this mains lead are coloured in accordance with the following code:

GREEN AND YELLOW	- EARTH
BLUE	- NEUTRAL
BROWN	- LIVE

If you fit your own plug, the colours of the wires in the mains lead of your appliance may not correspond with the markings identifying the terminals in your plug, this is what you have to do:

Connect the green and yellow (earth) wire to the terminal in the plug which is marked with the letter «E» or the earth \perp symbol or coloured green, or green and yellow.

Connect the blue (neutral) wire to the terminal in the plug which is marked with the letter «N» or coloured black.

Connect the brown (live) wire to the terminal which is marked with the letter «L» or coloured red.

The plug moulded on to the cord incorporates a fuse. For replacement, use a 13 Amp BS 1362 fuse.

Only ASTA approved fuses should be used.

The fuse cover/carrier must be replaced in the event of changing fuse.

The right fuse cover/carrier colour is the one shown by the coloured insert at the base of the plug.

The plug must not be used if the fuse cover/carrier is lost.

A replacement cover/carrier must be obtained from Zanussi Service Agents whose addresses are listed on the attached «Zanussi Service Force Directory» or you could find your local agent by looking in your telephone directory under 'Z'.

This appliance complies with E.E.C. directive no. 87/308 of 2.6.87 relative to radio interference suppression.

INSTALLATION INSTRUCTIONS

14

Level the washing machine by raising or lowering the feet. Accurate levelling prevents vibrations, noises and displacement of the washing machine during operation. After levelling the machine, secure the feet by tightening the ring nuts.

Some vibration is inevitable, especially if mounted on a wooden floor.

Sprung wooden floors are particularly susceptible to vibration. For advice, consult a builder. If possible, always place the machine on a solid floor.

NOTE

Please ensure that when the appliance is installed it is easily accessible for the engineer in the event of a breakdown.

All plumbing and electrical work required to install this appliance must be carried out by competent persons or qualified plumbers or electricians.

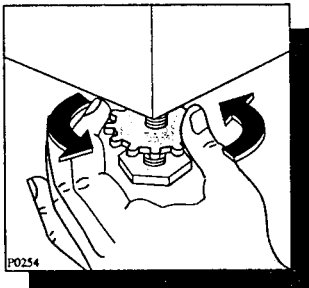

USE OF CONTROLS

The user must be familiar with the machine controls and use them correctly for best washing results.

1

WASHING POWDER

DISPENSER DRAWER

The washing powder and additives must be placed in this drawer before starting the programme.

There is also a brief guide to the washing programmes on the drawer itself.

Zanussi recommend the use of ARIEL detergents.

2

SUPER ECONOMY

BUTTON XE

By pressing in this push-button prior to selecting wash cycle A, you will obtain a reduction of the wash temperature from 95°C to 60°C whilst the duration of the programme will remain practically unchanged.

This will ensure a substantial saving in electricity consumption.

It is advisable to press in this push button particularly when washing strong white fabrics which do not have stubborn stains.

3

RINSE HOLD

BUTTON

Press this button to hold the water in the wash tub.

This is only for the use of synthetics and delicates.

The clothes are left suspended in water after the final rinse to prevent the formation of creases.

Press again to drain the water.

4

START/STOP BUTTON

By depressing this button the machine starts operating. When depressing it again, the machine stops.

The push button is provided with a child-proof safety lock.

Push the small slider placed on the button to lock it in the «off» position.

5

PROGRAMME CONTROL

To select the required programme press the knob to pop it out.

Turn the knob clockwise until the marker at the top of the dial coincides with the required programme letter.

Press the knob again if you wish to return it to its original position.

6

PILOT LIGHT

It lights up when the machine is operating.

HOW AND WHEN TO USE THE CONTROLS

START

After loading the laundry, place the washing powder and additives into the appropriate compartments. Before starting up the machine, check that:

- the appliance is plugged in
- the water supply taps are turned on
- the drain hose is correctly and securely positioned
- the door and the washing powder dispenser drawer are closed.

Depress the required pushbutton(s).

Select the required programme by pressing and turning the programme dial clockwise.

At this stage, press the «start/stop» button to start the programme up.

The pilot light comes on and the programme starts up

STOP

When the programme has finished, the programme dial will be in the «I» position and the washing machine will automatically stop.

If you have depressed the «Rinse Hold» button, the water remaining in the wash tub must be drained by pressing again the same button before opening the door.

The pilot light goes out.

Open the door **1 - 2 minutes** after the end of the programme to give the safety device time to unlock.

If necessary, stop the machine by pressing the «start/stop» button ① again.

At the end of the programme, all the buttons should be reset to the «rest» position (not depressed).

THE WASHING



















PROGRAMMES

This washing machine incorporates the «Jet System» washing for a rapid and economical wash, since the machine uses only the amount of water necessary to wash each load. This allows substantial savings of electricity, detergent and time, ensuring at the same time optimum washing results for all types of fabrics.

The following pages illustrating all the programmes provide a guide to the choice of the most suitable programme for your laundry.

The familiar wash code symbols which are found on the care labels in most clothes will gradually disappear and a new set of codes will be introduced. This change is due to changes in fabrics and detergents and

because people are tending to use fewer programmes and mix fabrics in one load. The change will bring the codes into line with the labelling used in the rest of Europe.









Old Symbol	New Symbol	Wash Action	Fabric
		Normal (Maximum)	White Cotton or Linen without Special Finishes
		Normal (Maximum)	Cotton, Linen or Viscose without Special Finishes Colourfast at 60° C.
	No longer used. White Nylon, Polyester/Cotton mixtures now included in 		
		Reduced (Medium)	Nylon, Polyester/Cotton, Viscose with Special Finishes: Cotton/Acrylic Mix.
		Normal (Maximum)	Cotton, Linen or Viscose Colourfast at 40°C but not 60°C.
		Reduced (Medium)	Acrylics, Acetate, Triacetate, Wool mixes, Polyester/wool blends.
		Much Reduced (Minimum)	Wool, wool mixes. Silks.
	No longer used. Silk now included in  ; printed acetate included in 		
	No longer used.		

The new symbols have been used on the Programme Guide of this machine, and are listed in the Programme Charts on page 14 and 15.

The new wash symbols will also appear on the side of Washing Powder packets.

PROGRAMMES FOR COTTON AND LINEN

Recommended load: max. 4.5 kg (10 lb)

PROGRAMME	DEGREE OF SOIL	COMPARTMENTS TO USE (☉ if required)	PROGRAMME DIAL POSITION	DESCRIPTION
 95 WHITES with prewash	Heavy		N	Prewash Wash at 95°C Rinses Spin
 95 WHITES (Boilwash)	Heavy		A	Wash at 95°C Rinses Spin
 60 WHITES COLOURED (Cotton/Polycottons)	Normal		B	Wash at 60°C Rinses Spin
 40 NON - FAST COLOURED	Normal		C	Wash at 40°C Rinses Spin
SPIN (800 rpm)			D	Long spin. Always preceded by a low-speed draining phase

Water filling











40°/50°C programmes - cold water filling

60°C programmes - hot and cold filling

95°C programmes - hot water filling only

PROGRAMMES FOR SYNTHETICS, MIXED FABRICS SILK AND WOOL

Recommended load: max. 2 kg (4.5 lb); wool max. 1 kg (2.2 lb)

PROGRAMME	DEGREE OF SOIL	COMPARTMENTS TO USE (⊗ if required)	PROGRAMME DIAL POSITION	DESCRIPTION
 50 MIXED FABRICS	Normal		F	Wash at 50°C Rinse Drain (*)
 40 DELICATES/ SYNTHETICS	Normal		G	Wash at 40°C Rinse Drain (*)
 40 WOOL 	Normal		H	Wash at 40°C Rinse Drain (*)
WORN ONCE	Light		J	Wash at 30°C Rinse Drain (*)
HAND RINSES			K	Rinse with additive if required Drain (*)
FRESHEN UP			L	1 rinse with additive if required Drain (*)
DRAIN			M	Draining of water

(*) if the RINSE HOLD button has not been depressed

USE OF DETERGENT AND ADDITIVES

Choosing the right washing powder. Always use a low lather powder. This is important as too much lather prevents the articles from being properly cleansed and you may damage the machine. **Ariel Automatic** is specially designed to complement the cleaning action of the machine.

USE OF WASHING

POWDER

The washing powder should be placed in the appropriate compartments in the washing powder dispenser drawer before starting the programme.

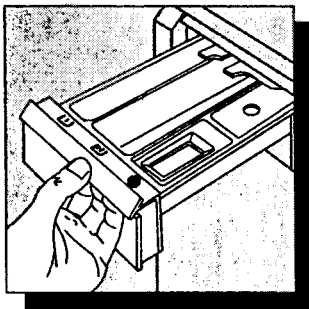

The compartment marked with the symbol **U** is for the prewash powder (if required by the programme).

The compartment marked with the symbol **W** is for the main wash powder.

HOW MUCH

DETERGENT?

Your washing machine has a unique water circulation system which runs continuously. This means that it uses detergent sparingly.

Initially you are advised to use less than the quantity specified by the detergent manufacturer.

Subsequently it is worth experimenting to see if your laundry comes out clean with smaller quantities.

Powder residue left on the clothes at the end of a wash indicates the use of too much powder. If the drum is only half-full, you can obviously use less detergent.

USE OF LIQUID

DETERGENT

Suitable liquid detergent such as Ariel can be used instead of washing powder.

In this case a programme without prewash must be selected.

Pour the liquid detergent into the compartment  in the dispenser drawer immediately before starting the wash programme. If the detergent has its own dispenser ball, this should be used according to the manufacturer's instructions.

USE OF LIQUID

ADDITIVES

Any liquid additives for softening or dressing the laundry must be poured into the appropriate compartment of the washing powder dispenser drawer before starting the programme.

The compartment marked with the symbol  is for softeners and dressing agents; never exceed the MAX level.

NOTE

Once the dispenser is filled, close it by pushing it in gently. This is particularly important if you are using fabric conditioner because if the drawer is slammed it will cause the conditioner to enter the machine prematurely.

WASHING NET

CURTAINS

To avoid excessive and damaging amount of lather, it is advisable to wash large curtains singularly and take extra care when measuring the detergent.

Should an excess of lather accidentally occur, switch off the machine, advance the programme to a short spin sequence which is preceded by a drain cycle, to remove the lather and then start the wash again.

WASHING 4 KG OF WHITE 'COTTON AT 95° C

Suppose you have 4 kg of normally dirty laundry to wash. It is white cotton and is suitable for high temperature washing.

1 LOAD THE LAUNDRY

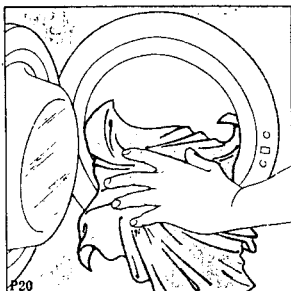

Open the door by pulling the catch outwards. Load the items to be washed one at a time and close the door.

2 MEASURE OUT THE WASHING POWDER

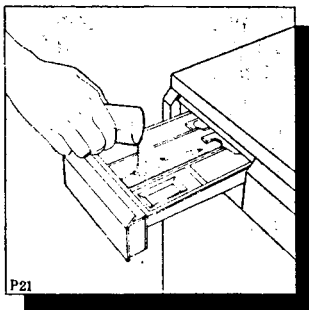

Measure the required quantity of washing powder and pour into the compartment marked **W**, the main wash compartment.

3 MEASURE OUT THE ADDITIVES

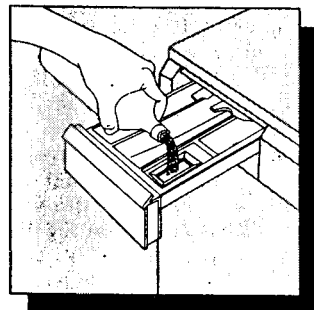

Pour the softener, if required, into the compartment marked **⊗**; do not exceed the MAX level. Close the drawer gently.

WASHING 4 KG OF WHITE COTTON AT 95° C

4 SELECT THE PROGRAMME

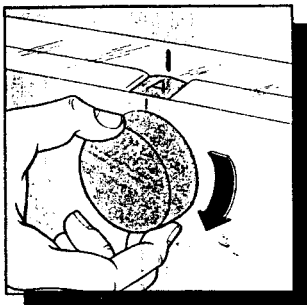

Turn the programme dial **clockwise** until letter **A** on the dial coincides with the red marker line.

5 START UP

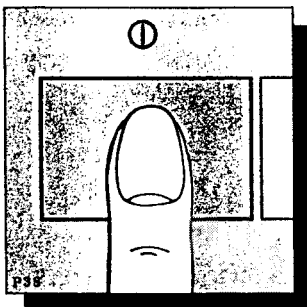

Check that:

- the appliance is plugged in,
- the water taps are on,
- the drain hose is correctly positioned.

Then push in the «start/stop» button .

The pilot lamp comes on and the washing machine starts to work.

6 AT THE END OF THE PROGRAMME

The machine automatically stops and the pilot light goes out. Push the «start/stop» button  again.

The door is controlled by a safety device which releases 1 - 2 minutes after the end of the programme.

When the programme has finished you are advised to unplug the appliance and turn off the water taps.

WASHING 2 KG OF SYNTHETIC FABRICS AT 40°C

Suppose you have 2 kg of synthetic fabric laundry to wash. They are rather delicate fabrics and should not be washed at a high temperature.

1

LOAD

THE LAUNDRY

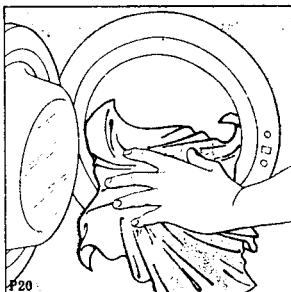



Open the door by pulling the catch outwards. Load the items to be washed one at a time and close the door.

2

MEASURE OUT

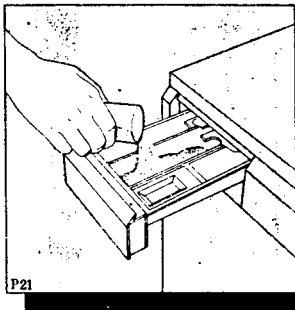
THE WASHING POWDER





Measure the required quantity of washing powder and pour into the compartment marked , the main wash compartment.

3

MEASURE OUT

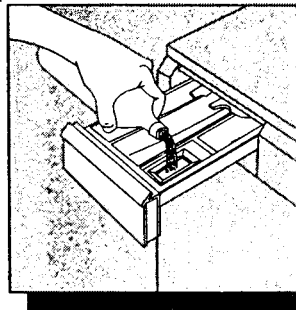
THE ADDITIVES

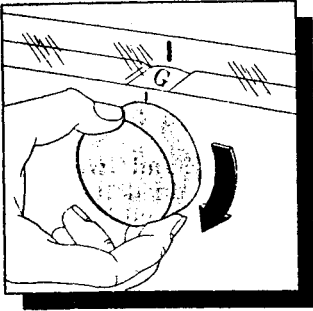

Pour the softener, if required, into the compartment marked ; do not exceed the MAX level. Close the drawer gently.

4**SELECT
THE PROGRAMME**

Turn the programme dial **clockwise** until letter **G** on the dial coincides with the red marker line.

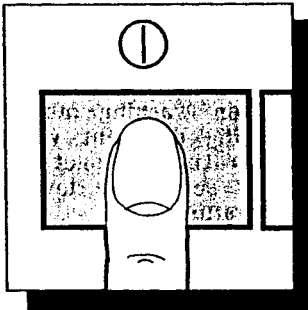
5**START UP**

Check that:

- the appliance is plugged in;
- the water taps are on,
- the drain hose is correctly positioned.

Then, push the «start/stop» button .

The pilot lamp comes on and the washing machine starts to work.

6**AT THE END OF
THE PROGRAMME**

The machine automatically stops and the pilot light goes out. Press the «start/stop» button  again.

The door is controlled by a safety device which releases 1 - 2 minutes after the end of the programme.

When the programme has finished you are advised to unplug the appliance and turn off the water taps.

WASHING HINTS

● Do not overload the washing machine. Weigh the laundry the first few times you use the washing machine.

The average weights of the most common items are listed below as a guide:

sheet	700-1000 gr.
pillow case	100- 200 gr.
tablecloth	400- 500 gr.
serviette	50- 100 gr.
tea towel	70- 120 gr.
linen hand towel	100- 150 gr.
towelling hand towel	150- 250 gr.
towelling bath towel	700-1000 gr.
bath robe	1000-1500 gr.
man's shirt	200- 300 gr.
apron	150- 200 gr.

● Load the laundry loosely alternating large items with small ones.

● Sort the laundry according to the type of fabric, colour-fastness and how dirty it is.

● Avoid washing un-hemmed or torn items as they may unravel.

● Before washing, empty all pockets of small objects which may have been left inside (coins, keys, screws etc.).

● When washing curtains, remove the hooks.

● Close poppers and zips and fasten loose buttons.

● It is essential to wash new coloured items separately when washing them for the first time.

● When washing fabrics requiring different wash temperatures together, always select the lowest temperature.

● White items should not be washed with coloured items.

● Very small items (handkerchiefs, ribbons, socks etc.) should be washed in a washing bag.

● Use a good quality detergent suitable for automatic washing machines.

● Use the correct quantities of detergent.

● For wool, use gentle detergents only in small quantities.

● Bleach is very corrosive; it should be used with care and kept out of reach of children.

● Some stains such as fruit, wine, grass, rust etc. are difficult to remove and should be treated before washing with specific products which can be found in most household shops. In some cases it may help to soak the stain before washing with a special pre-soak product or biological detergent.

● Only wool marked «Pure New Wool - washable, preshrunk» can be washed in the machine using the wool programme; other types of wool should be washed by hand or dry cleaned.

● Damp laundry should be hung out to dry as soon as possible after finishing the wash.

Knitwear and woollens should be dried flat away from direct sunlight.

● Once you have finished using the machine, you are advised to unplug it and turn off the water tap.

MAINTENANCE

Successful washing and smooth running of your machine depend on a series of routine maintenance operations which should be carried out from time to time.

IMPORTANT

You are advised to unplug the appliance before all cleaning and maintenance operations.

DECALCIFICATION

The water we normally use contains lime. From time to time, and more often for hard water, it is a good idea to use a water softening powder in the machine. Add this powder according to the softening powder manufacturer's instructions. This will help to prevent the formation of lime deposits.

AFTER EACH

WASH

Leave the door open for a while. This helps prevent mould and stagnant smells forming inside the appliance.

EXTERNAL CLEANING

Use soap and water only and then dry thoroughly.

CLEANING

THE DRAWER

From time to time the washing powder and additive dispenser drawer should be cleaned.

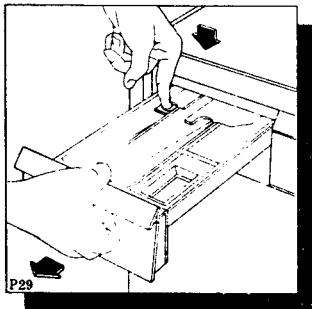

Remove the drawer and flush out under a tap.

The upper part of the additives compartment can be removed for easier cleaning.

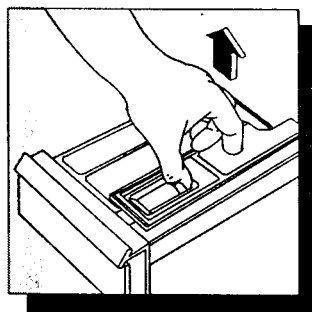

CLEANING

THE DRAWER RECESS

Having removed the drawer, use a small brush to clean the recess ensuring that all washing powder residue is removed from the upper part of the recess. Replace the drawer and run programme «C» for a few minu-

tes without any clothes and then the drain (M) cycle to clear any residues.

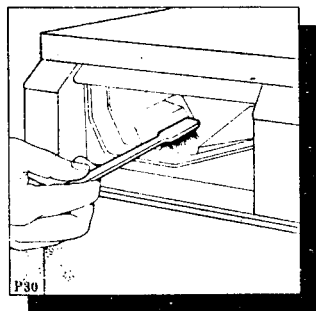

THE DANGERS OF FREEZING

If the machine is exposed to temperatures below 0°C; certain precautions should be taken.

- Turn off the water taps.
- Select a wash programme and run for a few seconds.
- Unscrew the inlet hoses.
- Unhook the drain hose from the rear support and position the end in a bowl. Run the draining programme for a few seconds.
- When you intend to start the machine up again, make sure that the room temperature is above 0°C.

CLEANING THE FILTER

THE WATER

DRAIN FILTER

A clean filter is important for correct functioning of the washing machine, and should therefore be cleaned after every wash.

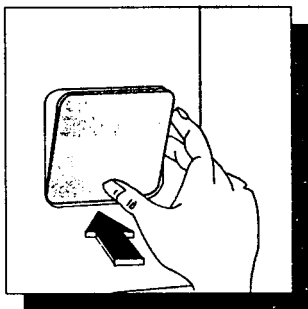

Open the panel covering the filter and place a container underneath to catch any spillage.

If the filter is blocked and the machine is unable to drain you will need to drain the water from the machine at this stage. To do this, unhook the drain hose from the standpipe or sink and hold the end of the hose over a bowl on the floor. The water should drain by gravity into the bowl. When the bowl is full, hook the hose back up and empty the bowl. Repeat the procedure until the water stops flowing out.

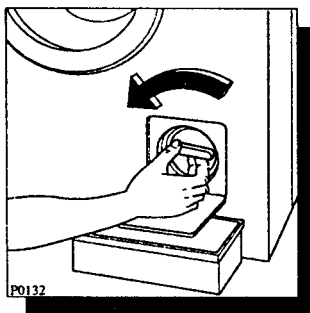

Unscrew the filter.

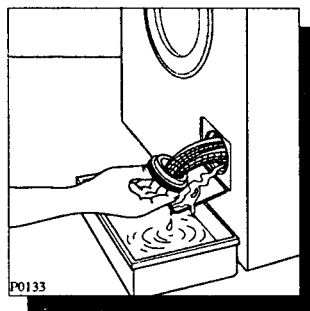

Remove the filter.

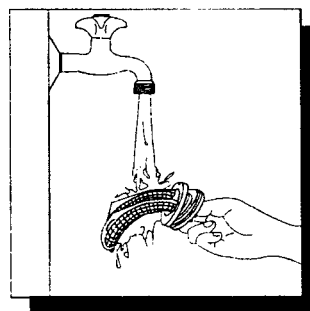

Clean carefully under a fast-running tap.

WARNING

When the appliance is in use and depending on the programme selected there can be hot water in the filter. Never remove the filter during a wash cycle, always wait until the appliance has finished the cycle, and is empty. When replacing the filter, ensure it is securely retightened. This will prevent leaks and also stop young children being able to remove the filter.

THE WATER

INLET FILTERS

If your water is very hard or contains traces of lime deposit, the water inlet filters may become clogged.

It is therefore a good idea to clean them from time to time. Turn off the water taps. Unscrew the water inlet hoses.

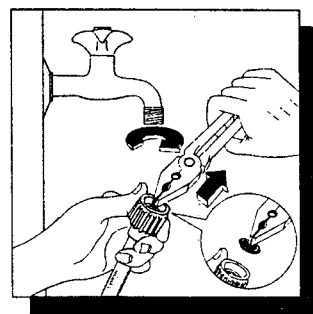

Remove and clean the filters using a hard bristle brush.

Replace the filters and tighten up the inlet hoses.

SERVICING

Certain problems are due to lack of simple maintenance or oversights and can be solved easily without having to call the Servicing Department.

PROBLEM	CAUSE	SOLUTION
<p>■ THE MACHINE DOES NOT START UP (with pilot light off)</p> <p>(with pilot light on)</p>	<ul style="list-style-type: none"> ● The «start/stop» button is not pressed in ● The child-proof safety lock on the start/stop button is in the "ON" position. ● The door is not closed properly ● The appliance is not plugged in ● There is no electric supply from the wall socket ● The programming dial is not correctly positioned ● No water is entering the machine 	<ul style="list-style-type: none"> ▶ Press the «start/stop» button ▶ Push the small slider to lock it in the OFF position. ▶ Close the door ▶ Plug the appliance in ▶ Check the fuse ▶ Consult a qualified electrician ▶ Press and turn the programme dial to the selected programme ▶ See solutions to the problem: THE MACHINE DOES NOT FILL
<p>■ THE MACHINE DOES NOT FILL</p>	<ul style="list-style-type: none"> ● The water tap is not on ● The water supply has been cut off ● The inlet hose is bent ● The water pressure is too low ● The water inlet filter is clogged 	<ul style="list-style-type: none"> ▶ Turn the tap on ▶ Wait until the water supply is restored ▶ Straighten the bend out ▶ If this occurs often, consult a qualified plumber ▶ Clean the filter (see page 24)
<p>■ THE MACHINE EMPTIES AS IT FILLS</p>	<ul style="list-style-type: none"> ● The end of the drain hose is too low ● The end of the drain hose is submerged in water ● Drain pipe without vent-hole 	<ul style="list-style-type: none"> ▶ Position the drain hose at the correct height (between 60 and 90 cm) ▶ The end of the drain hose must NOT be submerged ▶ Consult a qualified plumber
<p>■ THE MACHINE DOES NOT DRAIN OR SPIN</p>	<ul style="list-style-type: none"> ● You have pressed in the «Rinse Hold» button ● The drain filter is clogged ● The drain hose is bent ● The drainage system pipes are blocked ● The drain hose extension is incorrect 	<ul style="list-style-type: none"> ▶ Press this button again to drain the water ▶ Clean the filter. Before doing this, see page 24. ▶ Straighten the hose out ▶ Consult a qualified plumber ▶ Consult a qualified plumber

■ PROBLEM	● CAUSE	▶ SOLUTION
■ THE MACHINE LEAKS OR OVERFLOWS	● Too much washing powder	▶ Reduce the quantities of washing powder
	● Unsuitable washing powder	▶ Only use washing powder suitable for automatic machines
	● The inlet hose ring is loose	▶ Tighten the ring (see page 8)
	● The detergent dispenser drawer or recess are clogged	▶ Clean the drawer and recess (see page 23)
	● The end of the drain hose is not securely positioned	▶ Position the drain hose correctly
■ THE MACHINE VIBRATES OR IS NOISY	● The internal packing has not been removed	▶ Remove internal packing (see p. 7)
	● The machine is not level	▶ Adjust the feet (see page 10)
	● The machine is in contact with the wall or furniture	▶ Move the machine; it should rest freely on its feet
	● Washing load badly distributed	▶ Remember to shake out large items (e.g. sheets) when loading
	● The machine is overloaded	▶ Run the draining programme (M), reduce the load and continue
■ THE DOOR DOES NOT OPEN	● The safety device has locked it	▶ Wait 1 - 2 minutes after the end of the programme before opening the door
	● Water in the wash tub	▶ Drain the water by running the draining programme (M)

If, after the above checks, there is still a fault, call your nearest Zanussi Service Force Centre, whose address and telephone number can be found on the following pages.

Please make sure you give the model and serial number of the appliance. This information can be found on the rating plate (see picture), or on the guarantee certificate.

Original spare parts can be purchased from Zanussi Service Force Centres.

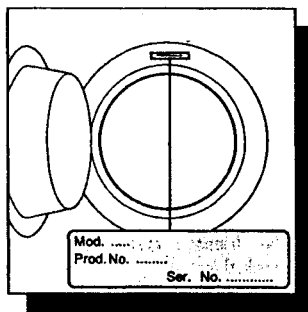

In-guarantee customers should ensure that the above checks have been made as the engineer will make a charge if the fault is not a mechanical or electrical breakdown.

Please note that proof of purchase is required for any in-guarantee service calls.

**How to find the telephone number of
your
Zanussi Service Force
listed in this leaflet**

Zanussi Service areas are allocated by postcodes which are listed in alphabetical order for easy reference.

1. Look for the two letters of your address postcode in the far left 'Postcode' column.
2. Match up the number of your postcode against the number listed in the 'Postcode Numbers' column.
3. Look across the column to the Service Force Key Number for your area. Turn to the last page of this directory for the address and telephone number to contact for service which is listed against your key number.

If you are unsure of your postcode, the main towns and cities are listed in alphabetical order for easy reference.

Additionally, your local Zanussi Service Force Centre telephone number is listed under 'Z' in your telephone directory.

The Customer Care Department at Zanussi House, Hambridge Road, Newbury, RG14 5EP, Tel: 0635 521313, will be happy to help you with any queries or difficulties.

For Service In The Republic Of Ireland

The telephone number of your service centre can be found in your Local Telephone Directory under 'Elektro Service' or 'Zanussi'. The information can also be found in the Golden Pages under 'Electrical Appliances - Repairing'.



Post-code Letter	Town	Post-code Number	Service Force Key Number	Post-code Letter	Town	Post-code Number	Service Force Key Number
AB	Aberdeen	1-5, 22-23, 30-38	1	DE	Derby	11-12	18
AB		41-45, 51-56	1	DE	Derby	4-5, 55	33
AL	St Albans	1-10	2	DG	Dumfries	1-7, 10-12, 14	34
A	Brecon	45	3	DG		8-9	34
BA	Bath	1-5, 11-15	4	DG	Dumfries	13	35
BA		7-10, 20-22	5	DH	Durham	1-9	37
BA		6, 16	6	DL	Darlington	1-17	37
BB	Blackburn	1-12	7	DN	Doncaster	1-7, 10-12, 22	33
BD	Bradford	1-23	8	DN		14	38
BD		24	7	DN	Doncaster	8-9, 15-21, 31-40	39
BH	Bournemouth	1-25	9				
BL	Bury	0-9	11	SUB POSTCODE DIVISION			
BN	Brighton	1-15,	12	DN	Gainsborough		
BN		20-27	12		South	21-1, 21-2, 21-5	40
BN		16-18	13	DN	Gainsborough		
BR	Bromley	1-8	14		North	21-3, 21-4	39
BS	Bristol	1-28, 88-89	15	DT	Dorchester	1-5, 10-11	9
BT	Belfast	1-82	16	DT		6-9	5
B	Birmingham	1-21, 25-33,	17				
B		38, 40, 45, 47-48,	17	SUB POSTCODE DIVISION			
B		60-71, 80, 90-94,		DT	Bridport East	6-3, 6-4	5
B		97-98	17	DT	Bridport West	6-5, 6-6	5
B	Birmingham	23-24, 34-37,	18				
B		42-44, 46, 72-	18	DY	Dudley	1-6, 8-9	17
B		79	18	DY		7, 10-14	41
B	Birmingham	49-50,	20	EC	London	All EC Codes	28
B		96	19	EH	Edinburgh	1-42, 46, 52-54	42
B	Birmingham	95	20	EH		43-45	35
CA	Carlisle	1-28	21	EH	Edinburgh	47-49, 51, 55	43
CB	Cambridge	1-8	22	EN	Enfield	1-11	28
CB		9-11	23	EX	Exeter	1-17, 20	45
CF	Cardiff	1-8, 31-48	3	EX		18-23, 31-39	46
CH	Chester	1-4	24	E	London	All East Codes	28
CH		5-7	25	FK	Falkirk	1-4	43
CH		8	26	FK		10-14, 18-19	32
CM	Chelmsford	0-6, 8-9, 11-15	27	FK	Falkirk	5-9, 15-17	47
CM		7	23	FK		20-21	31
CM	Chelmsford	16-24	28	FY	Fleetwood	0-8	7
CO	Colchester	1-16	23	GCI	Guernsey		48
CR	Croyden	0-9	29	GL	Gloucester	1-19,	49
CT	Canterbury	1-21	36	GL		50-56	49
CV	Coventry	1-8, 10-12, 21-23,	20	GL		20	19
CV		9, 13	18	GU	Guildford	1-24, 26, 34-35	50
CV	Coventry	31-37	20	GU		25	51
CW	Crewe	1-12	30	GU	Guildford	27-33	13
DA	Dartford	1-18	29	G	Glasgow	1-5, 11-15, 20-23,	47
DD	Dundee	1-5, 7-11	31	G		31-34, 40-46, 51-	47
DD		6	32	G	Glasgow	53, 58, 60-69, 73,	47
DE	Derby	1-3, 6-7, 13-15	10	G		76-78, 81-84	47
				G	Glasgow	71-72, 74-75	43

Post-code Letter	Town	Post-code Number	Service Force Key Number	Post-code Letter	Town	Post-code Number	Service Force Key Number
HA	Harrow	0-9	2	ME		1-2, 4-20, 99	36
HD	Huddersfield	1-8	8	MK	Milton Keynes	1-17, 19, 40-46	22
HG	Harrogate	1-5	8	MK		18	65
HP	Hemel	1-3	2	ML	Motherwell	1-12	43
HP	Hempstead	4-23	53	M	Manchester	1-35, 60	11
HR	Hereford	1-2, 4, 6-9	49	NE	Newcastle-on-Tyne	1-49, 61-70, 88	66
HR		3, 5	54	NE		98-99	66
HU	Hull	1-20, 55	38	NE		71	35
HX	Halifax	1-7	8	NG	Nottingham	1-14	10
IG	Ilford	1-11	28	NG		15-22, 25	33
IOM	Isle of Man		55	NG	Nottingham	23-24	40
IP	Ipswich	1-15, 30-31	56	NG		31-34	64
IP		16-27	57	NN	Northampton	1-7, 11-12	67
IP	Ipswich	28-29, 32-33	22	NN		8-10, 14-18	22
IV	Inverness	1-24, 26, 30-36,	58	NN	Northampton	13	65
IV		40-49, 51-56	58	NP	Newport	1-9, 44	3
IV	Inverness	25, 27-28	59	NR	Norwich	1-35	57
JCI	Jersey		60	NW	London	All NW Codes	52
KA	Kilmarnock	1-26, 28-30	43			Except 2,4,7,9,10	
KA		27	61	NW	London	2,4,7,9,10	2
KA		28	68	N	London	All N Codes	28
KT	Kingston-on-Thames	1-23	51	OL	Oldham	1-12, 15-16	11
KT		24	50	OL		13-14	7
KW	Wick	1-14	59	OX	Oxford	1-17	65
KW		15-17	62	PA	Paisley	1-4	47
KY	Kirkcaldy	1-16	32	PA		5-19	43
LA	Lancaster	1-23	7	PA	Paisley	20-27	68
LD	Llandrindod	1-8	54	PA		28-29, 41-49, 60-61	69
LD		3	3	PA		30-40	70
LE	Leicester	1-5, 7-8, 11-14,	63	PA		62-78	68
LE		16-17	63	PA	Paisley	80-82, 88	71
LE	Leicester	6, 9-10	63	PA		83-87	72
LE		15	64	PE	Peterborough	1-15, 34, 38	64
LL	Llandudno	11-15	25	PE		16-19	22
LL		16-19	26	PE	Peterborough	20-25	40
LL	Llandudno	20-21, 23, 27, 31-	25	PE		30-33, 35-37	57
LL		32, 34-40, 42-47	25	PH	Perth	1-2, 8-9, 10-18	31
LL	Llandudno	22, 24-26, 28-30,	26	PH		3-7	32
LL		33-34, 41, 48-49,	26	PH	Perth	19-26, 30-44	58
LL		51, 78	26	PL	Plymouth	1-21	73
LN	Lincoln	1-6, 8-10	40	PL		22-35	74
LN		7, 11-13	39	PO	Portsmouth	1-22	13
				PO	I.O.W.	30-41	75
				PR	Preston	1-9	7
				RG	Reading	1-17, 26	53
				RG		21-25, 27	50
				RG	Reading	28	4
				RH	Redhill	1-3, 6-7, 9-20	12
				RH		4-5	50
				RH	Redhill	8	29
SUB POSTCODE DIVISION							
LN	Lincoln	3-4, 3-5	40				
LN		3-6	39				
LS	Leeds	1-29	8				
LU	Luton	1-6	2				
LU		7	22				
L	Liverpool	1-49, 60-70	24				
ME	Medway	3	29				

Post-code Letter	Town	Post-code Number	Service Force Key Number	Post-code Letter	Town	Post-code Number	Service Force Key Number
RM	Rainford	1-5, 7, 10-18	27	TQ		14	45
RM		6, 8-9	28	TR	Truro	1-27	74
SA	Swansea	1-18, 31-32	3	TS	Stockton-on-		
SA		33-39, 41-44, 61-73	76		Tees	1-29	37
SA	Swansea	19-20, 40, 45-48	77	TW	Twickenham	1-20	51
SE	London	All SE Codes	14	UB	Uxbridge	1-10	2
SG	Stevenage	1-9, 11, 15	2	WA	Warrington	1-5, 8-9, 10-15	11
SG		10, 12-14	28	WA		6-7	24
SG	Stevenage	16-19	22	WA	Warrington	16	30
SK	Stockport	1-3, 6-12	30	WC	London	All WC Codes	44
SK		4-5, 13-16	11	WD	Watford	1-2, 4-7	2
SK	Stockport	17	33	WD		3	53
SL	Slough	1-10	53	WF	Wakefield	1-17	8
SM	Sutton	1-3, 7	51	WN	Wigan	1-5, 7	11
SM		4-6	29	WN		6, 8	24
SN	Swindon	1-8, 11-16	65	WR	Worcester	1-14	19
SN		9-10	4	WR		15	41
SO	Southampton	1, 4, 41 -43, 51	9	WS	Walsall	1-15	18
SO		2-3, 5, 21-24, 52	13	WV	Wolverhampton	1-4, 10-14	18
SO	Southampton	20	4	WV		5-9, 15-16	41
SP	Salisbury	1-5, 9-11	4	W	London	All West Codes	52
SP		6	9			Except 1-14	
SP	Salisbury	7-8	9	W	London	3, 4, 5, 7, 13	2
SR	Sunderland	1-7, 9	66	W	London	1-2, 6, 8-12, 14	44
SR		8	37	YO	York	1-3, 5, 7-8	8
SS	Southend-on-			YO		4, 6, 11-18, 25	38
	Sea	0-9, 11-17 ,99	27	YO	York	21-22	37
ST	Stoke-on-			ZE	Lerwick	1, 3	79
	Trent	1-18, 20-21	30	ZE		2	80
ST		19	18				
SW	London	2, 4, 8-9, 12, 16-17	14				
SW	London	1-3, 5-7, 10-11	44				
SW	London	13-15, 18	44				
SW	London	19-20	51				
SY	Shrewsbury	1-6, 9-17, 18-22	25				
SY		7, 17-19	54				
SY	Shrewsbury	8	41				
SY		23-25	77				
S	Sheffield	1-19, 30-31, 40-45	33				
S		60-66, 74, 80-81	33				
S	Sheffield	70-73, 75	8				
TA	Taunton	1-11, 21-24	6				
TA		12-20	5				
TD	Selkirk	1-15	35				
TF	Telford	1-8, 10-13	41				
TF		9	30				
TN	Tonbridge	1-2, 4, 8-11, 13-16	29				
TN		12, 17-19, 23-40	36				
TN	Tonbridge	3, 5-7	12				
TQ	Torquay	1-8, 9, 12-13	78				
TQ		7-8	73				

Service Force Key Number	Service Force Address	Telephone Number	Service Force Key Number	Service Force Address	Telephone Number
1	60 Commerce Street, Aberdeen, AB2 1BP	0224 583949	41	1 Underhill Street, Bridgnorth, Salop, WV16	0746 763322
	or Tel:	0224 582704	42	38 Buccleuch Street, Dalkeith, Midlothian, EH22	031 663 7758
2	Unit 4, Riverside Est. Coldharbour Ln, Harpenden	0582 461909	43	Block 2 Unit 5, Auchanraith Ind. Est Rosendale Way, Blantyre	0698 828145
3	3 Pentwyn Road, Blackwood, Gwent, Sth Wales	0495 223151	44	4 Royal Lane, Viewsley, W- Drayton, UB7	0895 441917
4	31 St Andrews Road, Bemerton, Salisbury, SP2	0722 336072	45	91 Exeter Road, Exmouth, Devon, EX8 10D	0395 263531
5	3 Bancombe Ct Trad Est., Martock, Yeovil, TA12	0935 822836	46	Unit 4, Uproct Ave, Pottington Ind Est, Barnstaple	0271 71774
6	6 Hamp Ind. Est. Bridgwater, Somerset, TA6 3NT	0278 424550	47	Unit E6C Anniesland Ind Est Netherton Rd, Glasgow, Scotland	041 954 5304
7	333 Ranglet Road, Walton Summit, Preston, PR5	0772 321200		or Tel:	041 954 5349
8	57 Ingram Road, Holbeck, Leeds, Yorks,	0532 460992	48	Blencathra, Saumarez Lane, Castel, Guernsey	0481 56854
9	63 Curzon Road, Bournemouth, BH1 4PW	0202 303363	49	134 Eastgate Street, Gloucester, GL1 10T	0452 422488
10	Unit 2, Furnace Road, Ilkeston, Derbyshire	0602 442770	50	Unit 1 Redfields Ind. Pk, Church Crooknam, Fleet	0252 851414
11	Unit 41/42 Clarendon Ct, Winwick Quay, W ton	0925 50822	51	127 Walton Road, Molesey, Surrey, KT8 0DT	081 9796366
12	Unit 3, 21/25 Bridge Road, Haywards Heath, RH1	0444 417656		or Tel:	081 9797962
13	266 Main Road, Southbourne, Emsworth, PO10	0243 374814	52	Unit 4, Riverside Est, Coldharbour Ln, Harpenden	0582 461909
	or Tel:	0243 371170	53	Reform Road, Maidenhead, Berkshire	0628 783711
14	9 Bourne Road, Bromley, Kent, BR2 9PB	081 3139533	54	Merion House, High Street, Llandrindod Wells	0597 824842
15	Unit 1, Albert Crescent, Bristol, BS2 0YH	0272 713217	55	South Quay Industrial Estate, Douglas, I O M.	0624 622114
16	Owenmore Hse, Kilwee Ind Est., Upper Dunmurry Lane, Belfast	0232 301121	56	Unit 2b, Elton Park Business Centre, Hadleigh Rd, Ipswich, IP2 0DQ	0473 211713
17	66 Birch Rd East, Wyreley Rd Ind Est, B'ham	021 327 1671	57	75 Grove Road, Norwich, NR1 3RL	0603 629653
18	Unit 3 Sterling Park, Claymore, Tamworth	0827 289800	58	Unit 3B3, Smithton Ind Est, Smithton, Inverness	0468 791822
	or Tel:	0827 289822	59	Drummuie Road, Golspie, Sutherland, KW10 6SY	0408 633517
19	22 Newton Road, Malvern, Worcester, WR141NZ	0684 572915	60	P O Box 45, Queens Road, St Helier, Jersey	0534 67001
	Unit 23/24, Alliance Business PK, Townsend Drv, Nuneaton, CV11	0203 350666	61	Bruach, Blackwaterfoot, Isle of Arran	077 086 246
21	High Ehenside, Egremont, Cumbria, CA22	0946 820509	62	Hatson Ind. Estate, Kirkwall, Orkney	0856 5457
22	1 Wharf Road, Higham Ferrers, Northants	0933 317727	63	75 St Marys Road, Market Harborough, Leics	0858 433229
23	Unit 2b, Elton Park Business Centre, Hadleigh Road, Ipswich IP2 1DQ	0473 211713	64	Pinfold Rd, Manning Rd Ind Est Bourne, Lincs	0778 422147
24	Unit 14, Dock Road, Birkenhead, L41 1JJ	051 639 1287	65	Unit E19, Telford Rd, Launton Ind Est Bicester	0869 248598
25	Plas Fynnon W/house, Middleton Rd. Oswestry	0691 652917	66	Unit C1, Bergen Ct, Tyne Tunnel Trad Estate, North Shields, Tyne & Wear	091 2960166
26	Easy Launderette, Pantton Hall, Denbigh, Clwyd	0745 81 3272	67	53 Sandringham Road, Northampton, NN1	0604 37061
27	19 Sirdar Rd. Off Brook Rd, Rayleigh, Essex	0268 741171	68	96 Argyll Street, Dunoon, Argyll, PA23 7NE	0369 2147
28	284 Alma Road, Enfield, EN3	081 805 6825	69	Inverasdale, Gallow Hill Rd, Cambeltown, Argyll	0586 553753
29	Unit B4, Imperial Bus. Estate, Gravesend, Kent	0474 353771	70	Moss Field Workshop, Moss Field Drive, Oban	0631 664530
30	Unit 8, Croft Road, Newcastle under Lyme, Staffs. ST5 0TW	0782 713003	71	2 Killweivagh, Gregory, Benbecula, Outer Hebrides	0870 2331
31	3-7 Blackness Street, Dundee, Scotland, DD1	0382 642828	72	Churchhouse, 16 James St, Stornaway, Isle of Lewis	0851 705555
	or Tel:	0382 455862	73	16 Faraday Mill, Cattedown, Plymouth, PL4	0752 257455
	or Tel:	0382 826809	74	80 Killigrew Street, Falmouth, Cornwall, TR11	0326 314600
32	33a Burnside, Auchtermuchty, Fife, Scotland	0337 28807	75	109-111 Hunnyhill, Newport, Isle of Wight	0983 523062
33	Unit 63, Storforth Ln Trad. Est. Chesterfield	0246 231790	76	Roch, Haverfordwest, Dyfed	0437 710366
34	93 Irish Street, Dumfries, Scotland	0387 69694	77	Unit 16, Llambod Ind. Est., Lampeter, SA48	0570 423424
35	2-8 Wood Market, Kelso, Borders, TD5 7AX	0573 24411	78	278 Torquay Road, Preston, Paignton	0803 529969
36	Unit 2, Bridge Rd Bus. Centre, Bridge Road, Ashford, Kent, TN23 1BB	0233 613463	79	3-4 Carlton Place, Lerwick, Shetland, ZE1	0595 2915
37	8 Cumbie Way, Aycliffe Ind. Est. Newton Aycliffe	0325 300606	80	Harlsdale, Symbister, Whalasaay, Shetland	08066 546
38	Unit 1, Boulevard Unit Fact. Est. Hull, HU3 4AY	0482 223335	81	London House, Victoria Str., Alderney	048182 3563
39	Unit 2, Cromwell Road, Grimsby, DN31 2BN	0472 358760			
40	Unit 14 Stonefield Park, Clifton Street, Lincoln	0522 532330			

PEACE OF MIND FOR TWELVE MONTHS

ZANUSSI

GUARANTEE

CONDITIONS

This guarantee is in addition to your statutory and other legal rights which will not be excluded or in any way diminished by the return of this guarantee card.

We, Zanussi Ltd., undertake that if, within twelve months of the date of the purchase, this ZANUSSI appliance or any part thereof is proved to be defective by reason only of faulty workmanship or materials, we will, at our option, repair or replace the same **FREE OF ANY CHARGE** for labour, materials or carriage on condition that:

- * The appliance has been correctly installed and used only on the electricity supply stated on the rating plate.
- * The appliance has been used for normal domestic purposes only, and in accordance with the manufacturer's operating and maintenance instructions.
- * The appliance has not been serviced, maintained, repaired, taken apart or tampered with by any person not authorised by us.
- * The appliance is still in the possession of the original purchaser.

All service work under this guarantee must be undertaken by a Zanussi Service Force Centre.

Home visits are made between 8.30 am and 5.30 pm Monday to Friday. Visits may be available outside these hours in which case a premium will be charged.

Any appliance or defective part replaced shall become our property.

EXCLUSIONS

This guarantee does not cover:

- * Damage or calls resulting from transportation, improper use or neglect, the replacement of any light bulbs or removable parts of glass or plastic.
- * Costs incurred for calls to put right machines improperly installed or calls to machines outside the UK and the Republic of Ireland.
- * Appliances found to be in use within a commercial or similar environment, plus those which are the subject to rental agreements.
- * Products of Zanussi manufacture which are NOT marketed by Zanussi Ltd.
- * EEC Countries - The standard guarantee is applicable but subject to the owner's responsibility and cost to ensure the appliance meets the standards set by the country to which the product is taken. The Zanussi company in the country concerned will be pleased to advise further. Sight of your purchase receipt will be required by them.

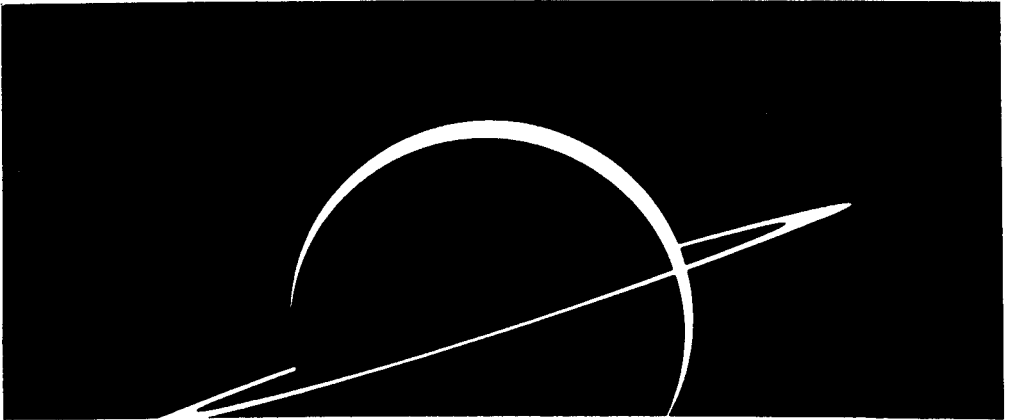

ZANUSSI

The appliance of science

Zanussi Ltd., Zanussi House, Newbury

The information in this manual is correct at time of going to press.
Zanussi reserve the right to alter specifications without notice.

Free Manuals Download Website

<http://myh66.com>

<http://usermanuals.us>

<http://www.somanuals.com>

<http://www.4manuals.cc>

<http://www.manual-lib.com>

<http://www.404manual.com>

<http://www.luxmanual.com>

<http://aubethermostatmanual.com>

Golf course search by state

<http://golfingnear.com>

Email search by domain

<http://emailbydomain.com>

Auto manuals search

<http://auto.somanuals.com>

TV manuals search

<http://tv.somanuals.com>