

# ZANUSSI

## WASHING MACHINE FLA 802 W

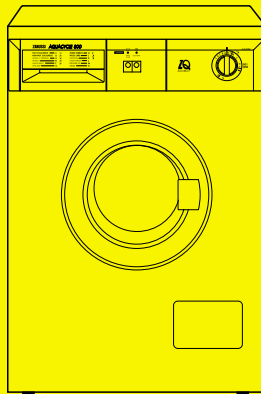

INSTRUCTION BOOKLET



# Important Safety Information

It is most important that this instruction book should be retained with the appliance for future reference. Should the appliance be sold or transferred to another owner, or should you move house and leave the appliance, always ensure that the book is supplied with the appliance in order that the new owner can get to know the functioning of the appliance and the relevant warnings.

This information has been provided in the interest of safety. You **MUST** read it carefully before installing or using the appliance.

## Installation

- This appliance is heavy. Care should be taken when moving it.
- It is dangerous to alter the specifications or attempt to modify this product in any way.
- All packing and transit bolts must be removed before use. Serious damage can occur to the product and to property if this is not adhered to. See relevant section in instructions.
- Any plumbing work required to install this appliance should be carried out by a qualified plumber or competent person.
- Any electrical work required to install this appliance should be carried out by a qualified electrician or competent person.
- Care must be taken to ensure that the appliance does not stand on the electrical supply cable.
- If the machine is situated on a carpeted floor, please adjust the feet in order to allow air to circulate freely.
- The washing machine must be unplugged when removing the interior transit bolts. Do not plug in the appliance before finishing the removal of the transit bolts and the fixing of the caps in the holes where the security bolts were

## Child Safety

- This appliance is designed to be operated by adults. Children should not be allowed to tamper with the controls or play with the product.
- Pets and children have been known to climb into washing machines. Please check your drum before use.
- The glass door becomes very hot during the washing cycle. Keep children away from the vicinity of the appliance whilst it is in operation.
- Keep all packaging well away from children.
- Keep all detergents in a safe place out of children's reach.

## During Use

- Always unplug the appliance and turn off the water after use.

- Do not overload the appliance. See relevant section in instruction book.
- Always look through the glass door to check if water has drained before opening the door.
- The user should always check that they have not left their gas lighter (disposable or otherwise) in their clothing
- Only wash fabrics which are designed to be machine washed. If in doubt, consult the care label on the clothes.
- Before washing, ensure that all pockets are empty and buttons and zips are fastened. Avoid washing frayed or torn articles and treat stains such as paint, ink, rust, and grass before washing. Underwired bras must NOT be machine washed.
- Any objects such as coins, safety pins, nails, screws, stones or any other hard, sharp material can cause extensive damage and must not be placed into the machine.
- Garments which have been in contact with volatile petroleum products should not be machine washed. If volatile cleaning fluids are used, care should be taken to ensure that the fluid is removed from the garment before placing in the machine.
- Wash small items such as socks, laces, washable belts etc in a washing bag or pillow case as it is possible for such items to slip down between the tub and the inner drum.
- Only use the advised quantities of fabric softener. Damage to the fabric can ensue if you over-fill. Refer to the manufacturer's recommendations of quantities.
- As some duvets and eiderdowns should be washed in large commercial machines because of their bulk, please check with the manufacturer of the item before washing in a domestic machine.
- Leave the porthole door slightly ajar between washes to preserve the door seal.
- Under no circumstances should you attempt to repair the machine yourself. Repairs carried out by inexperienced persons may cause injury or serious malfunctioning. Contact your local Zanussi Service Centre. Always insist on genuine Zanussi spare parts.

# Contents

## For the User

<b>Important Safety Information</b>	2
<b>Your New Washing Machine</b>	4
<b>Description of the Appliance</b>	5
<b>The Control Panel</b>	6
<b>Operating sequence</b>	7-10
Washing 4,5 kg of white cotton at 90 °C	7
Load the laundry	7
Measure out the detergent	7
Measure out the fabric softener	7
Select the required programme	7
Start the machine	8
At the end of the programme	8
Washing 2 kg of mixed fabrics at 50 °C	9
Load the laundry	9
Measure out the detergent	9
Measure out the fabric softener	9
Select the required option	9
Select the required programme	10
Start the machine	10
At the end of the programme	10
<b>Washing Hints</b>	11-13
Which detergent to use?....	12
And in which form?	13
How much detergent and fabric softener?	13
Using a water softening agent	13
<b>Wash Care Symbols</b>	14
<b>Washing Programmes</b>	15-16
<b>Maintenance and Cleaning</b>	17-18
Descaling	17
After each wash	17
External cleaning	17
Cleaning the dispenser drawer	17
Cleaning the drawer recess	17
Cleaning the filter	18
The dangers of freezing	18
Maintenance Wash	18
<b>Something Not Working</b>	19-20
<b>Service &amp; Spare Parts</b>	20
<b>Customer Care</b>	20
<b>Guarantee conditions</b>	21
<b>Zanussi Service Force Addresses</b>	22-23

## For the Installer

<b>Installation Instructions</b>	24
<b>Technical Specifications</b>	24
Unpacking	25
Positioning	26
Water inlet	26
Water drainage	27
Levelling	28
Special conditions	28
In the interest of the environment	28
Electrical connections	29
Permanent connection	29

## Guide to use the Instruction Book

The following symbols will be found in the text to guide you throughout the instructions:

-  **Safety instructions**
-  **Hints and tips**

**i**

# Your New Washing Machine

Your new washing machine, meets all modern needs for effective treatment of laundry with low water, energy and detergent consumption.

- **Automatic cooling of the wash water to 60°C** before draining, with the 90°C programme. This reduces thermal shock to fabrics, helping to prevent any creasing.
- **The special wool programme** with its new delicate wash system treats your woollens with extreme gentleness.
- **The anti-unbalance device** ensures that the washing machine remains stable when spinning.

## Ecological hints

To save water and energy and help protect the environment, we recommend that you follow these hints:

- Adjust the quantity of detergent according to the hardness of your water supply, the amount of laundry and the degree of soiling.
- Select an “economy” programme for normally soiled laundry and a “quick” programme for lightly soiled laundry.
- A programme without prewash is sufficient for normally soiled laundry.

## In the interest of the environment

- Materials marked with the symbol  are recyclable.
- Check with your local Council or Environmental Health Office to see if there are facilities in your area for re-cycling this appliance.
- When the appliance is to be scrapped, cut off the power supply cable and make the door closing device unusable to prevent young children from being trapped inside.
- Help to keep your country tidy - use authorised disposal sites for your old appliance.



**How do we help to protect the environment?  
We use recycled paper!**

# Description of the Appliance

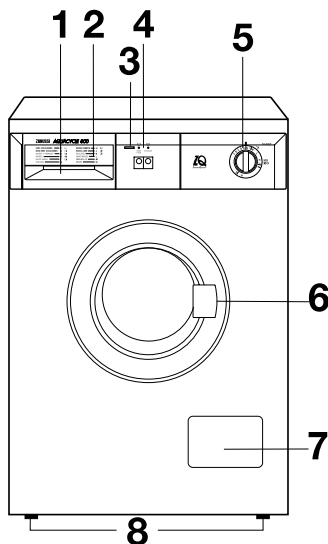
- 1 Detergent dispenser drawer
- 2 Programme guide
- 3 "Mains-on" light
- 4 "Options" buttons
- 5 Programme selector dial & ON/OFF switch
- 6 Door opening handle
- 7 Filter
- 8 Adjustable feet



## Detergent dispenser drawer

-  Prewash
-  Main Wash
-  Fabric softener

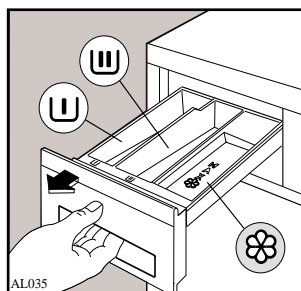

# The Control Panel

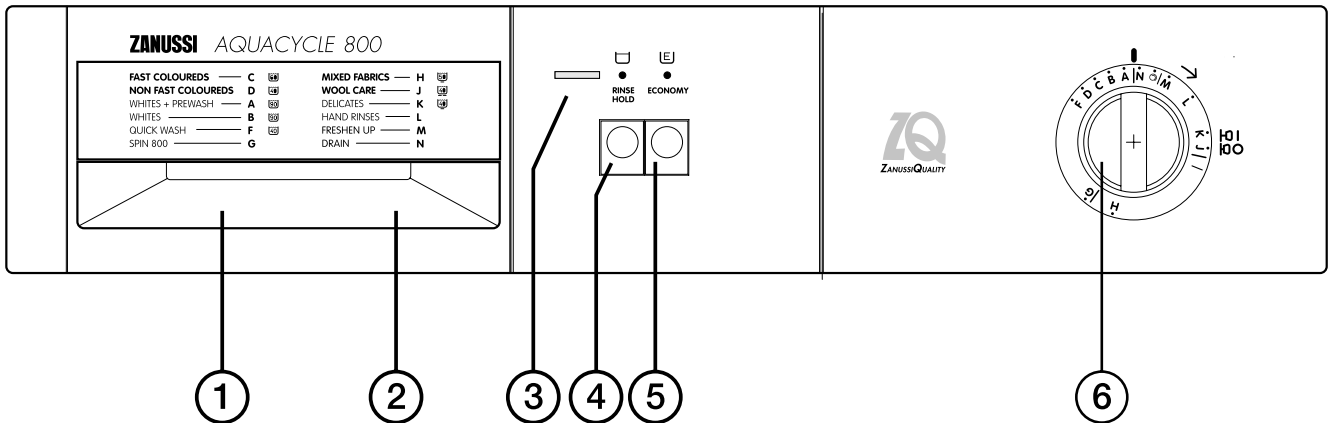

## 1 Detergent dispenser drawer

## 2 Programme Guide

## 3 Mains-on light

This light illuminates when the appliance is operating.

## 4 Rinse hold button

Press this button to make the machine stop with water in the drum after the synthetic or delicate wash cycles. This prevents any creasing which may take place if the clothes are left damp in the drum. When it is convenient for you to empty the machine, simply press this button again so that the machine can proceed to drain and short spin, or turn the dial to the drain programme “N”. If this button is not activated, the washing programmes will end with a short spin.

Do not press this button for woollens: wool items should be gently spun.

## 5 Economy button

By depressing this button prior to selecting wash programmes “B”, “C” and “H”, you will obtain a reduction of the temperature from 90°C to 60°C and from 60°/50°C to 40°C. The duration of the programme will not alter. This will ensure a substantial saving in electricity consumption. Use Economy when washing fabrics which are lightly soiled.

## 6. Programme Selector

To select the required programme turn the control clockwise until the marker on the top coincides with the number of the required programme (reference mark on the control panel). If you pass the required number **NEVER TURN THE CONTROL ANTICLOCKWISE** just continue clockwise until the required number is reached again.

# Operating Sequence

Before your first wash, we recommend that you run a cotton cycle at 60°C, without any laundry in the machine, to remove any manufacturing residue from the drum and tub.

Pour 1/2 a measure of detergent into the dispenser drawer and start the machine.

## WASHING 4.5 KG OF WHITE COTTON AT 90°C

Suppose you have 4.5 kg of heavily soiled laundry to wash. It is white cotton and is suitable for high temperature washing

### 1. Load the laundry

Open the door.

Place the laundry in the drum, one item at a time, shaking out as much as possible. Close the door.

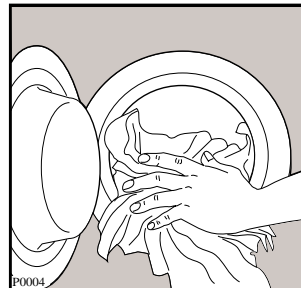

### 2. Measure out the detergent

Pull out the dispenser drawer until it stops.

Measure out the amount of detergent recommended by the manufacturer in a graduated cup and pour it into the main wash compartment .

If you wish to carry out a prewash(\*), pour detergent into the compartment marked .

(\* Prewash is available in programme "A".

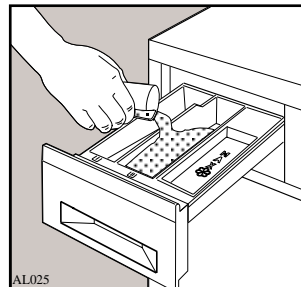

### 3. Add the fabric softener (if required)

If required, pour fabric softener into the compartment marked  (the amount used must not exceed the «MAX» mark in the drawer).

Close the drawer gently

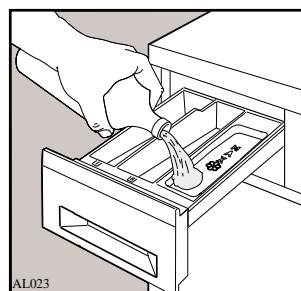

### 4. Select the required programme

Turn the programme selector dial **CLOCKWISE** to the required programme.

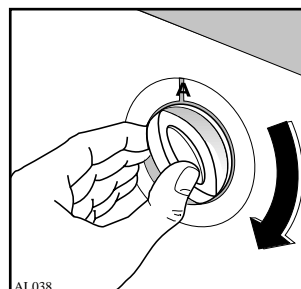

## 5. Start the machine

Before starting up the machine check that:

- the appliance is plugged in
- the water supply taps are turned on
- the door and the detergent dispenser drawer are closed.

Pull the programme selector dial outwards

The operating pilot light will illuminate and the machine will start operating

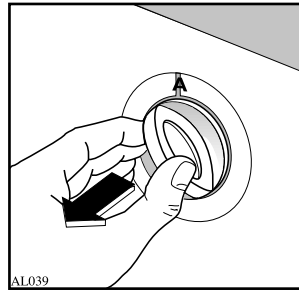

## 6. At the end of the programme

The machine stops automatically and the mains-on light goes out.

The door is controlled by a safety device which releases 3 minutes after the end of the programme.

**Before opening the door ensure there is no water in the drum.**

Switch the machine off by pushing in the programme selector dial.

When the programme has finished, you are advised to unplug the appliance and turn off the water taps

Leave the door open to prevent the formation of mildew and unpleasant smells.



## WASHING 2 KG OF MIXED FABRICS AT 50 °C

Suppose you have 2 kg of MIXED FABRICS to wash. They are rather delicate fabrics and should not be washed at a high temperature.

### 1. Load the laundry

Open the door.

Place the laundry in the drum, one item at a time, shaking out as much as possible. Close the door.



### 2. Measure out the detergent

Pull out the dispenser drawer until it stops.

Measure out the amount of detergent recommended by the manufacturer in a graduated cup and pour it into the main wash compartment .

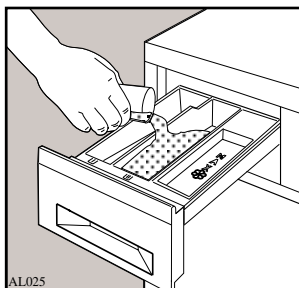

### 3. Add the fabric softener (if required)

If required, pour fabric softener into the compartment marked  (the amount used must not exceed the «MAX» mark in the drawer).

Close the drawer gently.

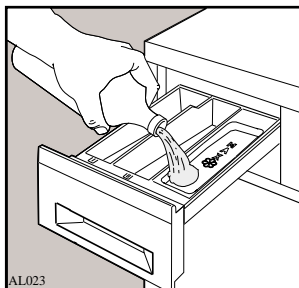

### 4. Select the required option(S)

Depress Rinse Hold button , if required

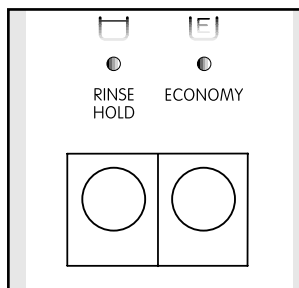

## 5. Select the required programme

Turn the programme selector dial **CLOCKWISE** to the required programme

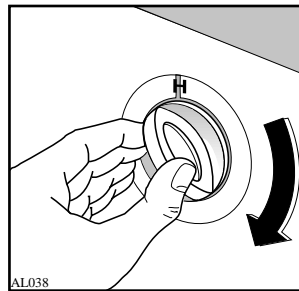

## 6. Start the machine

Before starting up the machine check that:

- the appliance is plugged in
- the water supply taps are turned on
- the door and the detergent dispenser drawer are closed.

Pull the programme selector dial outwards

The mains-on light will illuminate and the machine will start operating

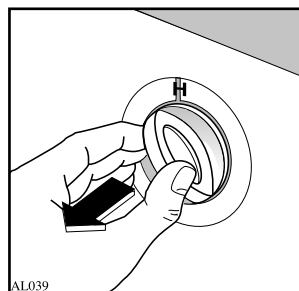

## 7. At the end of the programme

The machine stops automatically and the mains-on light goes out.

If you have depressed the Rinse Hold button , the machine will stop with the water left in the tub, to prevent the fabric from creasing. To drain the water release the same button (the clothes will be gently spun) or select programme “N”

The door is controlled by a safety device which releases 3 minutes after the end of the programme.

**Before opening the door ensure there is no water in the drum.**

Switch the machine off by pushing in the programme selector dial.

When the programme has finished, you are advised to unplug the appliance and turn off the water taps

Leave the door open to prevent the formation of mildew and unpleasant smells.

# **i** Washing Hints

Do **NOT** overload the machine. Weigh the laundry the first few times you use the appliance.

The average weights of the most common items are listed below as a guide:

**1000g = 1 kg**

Sheet	700-1000 g
Pillow case	100-200 g
Tablecloth	400-500 g
Serviette	50-100 g
Tea towel	70-120 g
Linen hand towel	100-150 g
Towelling hand towel	150-250 g
Towelling bath towel	700-1000 g
Bath robe	1000-1500 g
Man's shirt	200-300 g
Apron	150-200 g

- Load the laundry loosely alternating large items with small ones.
- Sort the laundry according to the type of fabric, colour-fastness and how dirty it is.
- Avoid washing unhemmed or torn items as they may unravel.
- Before washing, empty all pockets of small objects which may have been left inside (coins, keys, screws etc). as these could damage the drain pump.
- When washing curtains, remove the hooks.
- Close poppers and zips and fasten loose buttons.
- It is essential to wash new coloured items separately when washing for the first time.
- When washing fabrics requiring different wash temperatures together, always select the lowest temperature.
- White items should not be washed with coloured items.
- Very small items (handkerchiefs, ribbons, socks etc) should be washed in a washing bag or a pillow case.
- Use a good quality detergent suitable for automatic washing machines.
- Use the correct quantities of detergent.
- For wool, use gentle detergent only in small quantities.
- Bleach is very corrosive; it should be used with care and kept out of reach of children.
- Some stains such as fruit, wine, grass, rust etc. are difficult to remove and should be treated before washing with specific products, which can be found in most household shops. In some cases it may help to soak the stain before washing with a special pre-soak product or biological detergent.
- Only wool marked «Pure New Wool - washable, preshrunk» can be washed in the machine using the wool programme; other types of wool should be washed by hand or dry cleaned.
- If you have used the machine to wash, rinse or spin only non-colour fast garments, there may be dye left in the sump. To ensure any subsequent wash is not contaminated with the dye, select and carry out a rinse and spin programme, without any garments, to ensure that any dye is removed from the sump.
- Once you have finished using the machine, you are advised to unplug it and turn off the water taps.
- To avoid an excessive and damaging amount of lather when washing net curtains, it is advisable to wash large curtains singularly and take extra care when measuring the detergent.
- Should an excess of lather accidentally occur, switch off the machine, select the spin programme which is preceded by a drain cycle, to remove the lather and then start the wash again.

## Which detergent to use?....

To ensure you obtain the best wash results from your appliance, it is important to use the right detergent in your everyday wash, and only detergents recommended for use in automatic machines.

To maintain the appearance of your clothes and household textiles and to make them last longer you should use different types of detergent for different washes, whether for whites, colours or delicates.

### Whites

We recommend the Ariel product range which is biological and designed to provide excellent cleaning and stain removal even at low temperatures.



### Non Biological

If you prefer to use a non biological detergent, which does not contain enzymes we recommend Fairy. Fairy provides good cleaning and stain removal.



### Coloureds

For coloured items you should use a detergent which is designed to clean while maintaining the original colour. Ariel Color does not contain bleach and therefore helps to preserve colours.



### Delicate Items

When washing delicates such as woollens, you should use a product which is specially designed to care for fine fabrics. Dreft Automatic is suitable for woollens and other delicates.



### Laundry Bleach

For additional stain removal you may wish to use a product such as Ace Gentle Bleach which is used in addition to your chosen detergent. Ace is suitable for all washable fabrics including silks, woollens and coloureds.



## And in which form?

Not only are there different types of detergent, but they are also available in different forms. Whether you choose a powder or liquid in traditional or compact form is down to personal choice.

### Traditional Powders

Pour the powder directly into the dispenser drawer. Do not sprinkle powder onto clothes in the machine drum.

### Traditional Liquids

Liquid can be placed in the main wash compartment of the detergent drawer marked with the symbol , start the machine immediately upon placing the detergent in the dispenser drawer.

Alternatively the detergent is measured into the specially designed dosing device\* which should be placed on top of the laundry, and at the back of the machine drum.

### Compact Powders and Liquids

Compact detergents (or concentrates as they are also known) are available in liquid or powder form, and generally require a smaller dosage. Follow the manufacturer's instructions to ensure the most economical usage. Pour the detergent directly into the dispenser drawer, or alternatively measure the detergent into the specially designed dosing device\* which should be placed on top of the laundry, and at the back of the machine drum.

**\*If you use a dosing device in a washer dryer, please ensure the dosing device/ball is removed before carrying out a drying programme.**

### Fabric Conditioners

These are ideal for improving "softness", and also reduce static cling on synthetics and make ironing easier. They are available in two types:

For example Lenor liquid fabric softener, for use in the washing machine/washer dryer. The liquid fabric softener should be poured into the compartment marked with the symbol .

Follow the manufacturer's dosage instructions and never exceed the MAX level.



Bounce conditioning sheets for use in a tumble dryer. We recommend the conditioning sheets are pinned (using a safety pin) to an article of laundry and placed in the tumble dryer.



## How much detergent and fabric softener?

The amount to be used depends on:

the load:

if the detergent manufacturer does not make any specification for small loads, use a third less for half loads, and for very small loads only use half of the amount of washing powder recommended for a full load.

the degree of soiling of the washing:

for only lightly soiled washing use less washing powder. Follow the instructions of the detergent manufacturer.

the water hardness:

















the harder the water, the higher the dosage!

## Using a water softening agent

In hard water areas, the use of a water softening agent can reduce the amount of detergent necessary. See manufacturers recommendations.

# Wash Care Symbols

Wash care labels inside garments recommend how to launder your clothes with the best results. The care labelling code is in line with care labelling used in the rest of Europe. The symbols used make it easy to select the correct programme on your washing machine.

WASHING SYMBOL	WASH ACTION	FABRIC
	Normal (Maximum)	White Cotton or Linen without Special Finishes
	Normal (Maximum)	Cotton, Linen or Viscose without Special Finishes Colour fast at 60°C.
	Reduced (Medium)	Nylon, Polyester/Cotton, Viscose with Special Finishes, Cotton/Acrylic Mix.
	Normal (Maximum)	Cotton, Linen or Viscose Colour fast at 40°C but not 60°C.
	Reduced (Medium)	Acrylics, Acetate, Triacetate, Wool mixes, Polyester/wool blends.
	Much Reduced (Minimum)	Wool, wool mixtures, Silks
	Hand wash only	Do not machine wash
<b>BLEACHING</b>		
	Chlorine bleach may be used	
<b>IRONING</b>		
	Hot iron	Cotton, Linen, Viscose
	Warm iron	Polyester mixtures, Wool
	Cool iron	Acrylic, Nylon, Polyester
<b>DRY CLEANING</b>		
	May be dry cleaned. Other letters and/or a bar beneath the circle will indicate the required process to the dry cleaner.	
<b>TUMBLE DRYING</b>		
	May be tumble dried	
	with high heat setting	
	with low heat setting	
	A cross through any symbol means «DO NOT»	









## Important Notes

For best results, always use the dispenser drawer for dispensing detergents and liquid additives. Once the dispenser has been filled, close it by pushing it in gently. This is particularly important if you are using fabric conditioner to avoid the conditioner entering the machine prematurely.

When using liquid detergent and a prewash programme, place the detergent into the correct compartment in the dispenser drawer, after the prewash has finished.

# Washing Programmes

## Programmes for cotton and linen

Wash programme	Degree of soil and type of laundry	Programme dial position	Description	Possible options	Max. load
 <b>Whites+Prewash</b>	White cotton, for example heavy soiled work garments, sheets, household linen, underwear, towels.	<b>A</b>	Prewash at 40 °C Wash at 90°C 4 rinses Long spin at 800 rpm		4.5 kg
 <b>Whites</b>	White cotton, for example normally soiled sheets and household linen.	<b>B</b>	Wash at 90°C 4 rinses Long spin at 800 rpm		4.5 kg
 <b>Whites+ Economy</b>	White cotton economy, for example lightly soiled sheets and household linen.	<b>B +  (*)</b>	Wash at 60°C 4 rinses Long spin at 800 rpm		4.5 kg
 <b>Fast coloureds</b>	Coloured cotton or linen fabric, shirts, underwear, towels.	<b>C</b>	Wash at 60°C 4 rinses Long spin at 800 rpm		4.5 kg
 <b>Fast coloureds + Economy</b>	Coloured garments economy, for example delicate coloureds, men's shirts, blouses, underwear.	<b>C + </b>	Wash at 40°C 4 rinses Long spin at 800 rpm		4.5 kg
 <b>Non Fast Coloureds</b>	Non fast coloured cotton or linen fabrics, shirts, blouses, underwear.	<b>D</b>	Wash at 40°C 4 rinses Long spin at 800 rpm		4.5 kg
 <b>Quick wash</b>	Lightly soiled laundry such as sport apparel, sheets used once.	<b>F</b>	Wash at 40°C 4 rinses Long spin at 800 rpm		4.5 kg
<b>Spin 800 rpm</b>	Separate spin for cotton and linen items	<b>G</b>	Long spin at 800 rpm		4.5 kg

(\*)This 60°C programme is the reference programme for the Energy label according to EEC Directive 92/75.













Water 67 litres  
 Energy 1,2 kWh  
 Time 125 minutes

Water filling:

Programmes 30°-40°C **cold** water filling  
 Programmes 50°-60°C **hot and cold** water filling  
 Programmes 90°C **hot** water filling

# Washing Programmes

## Programmes for synthetics, delicates and wool

Wash programme	Degree of soil and type of laundry	Programme dial position	Description	Possible options	Max. load
 <b>Mixed Fabrics</b>	Synthetic or mixed fabrics, underwear, coloured garments, non-shrink shirts, blouses. (Normally soiled)	<b>H</b>	Wash at 50°C 3 rinses Short spin at 600 rpm		2 kg
 <b>Mixed Fabrics +Economy</b>	Synthetic or mixed fabrics, underwear, coloured garments, non-shrink shirts, blouses.	<b>H + </b>	Wash at 40°C 3 rinses Short spin at 600 rpm		2 kg
 <b>Wool Care</b>	Specially tested programme for wool garments	<b>J</b>	Wash at 40°C 3 rinses Short spin at 600 rpm		1 kg
 <b>Delicates</b>	Delicate fabrics, for example curtains.	<b>K</b>	Wash at 40°C 3 rinses Short spin at 600 rpm		2 kg
<b>Hand Rinses</b>	This programme can be used for rinsing hand washed garments.	<b>L</b>	3 rinses (with fabric softener if required). Short spin at 600 rpm		2 kg
<b>Freshen Up</b>	Laundry which needs freshening up	<b>M</b>	1 rinse with fabric softener and short spin at 600 rpm		2 kg
	Separate spin for synthetics and delicates		Draining of water and short spin at 600 rpm.		2 kg
<b>Drain</b>	For emptying out the last rinse water in programs with Rinse Hold option	<b>N</b>	Draining of water		-



# Maintenance and Cleaning

 Before any maintenance or cleaning is carried out you must **DISCONNECT** the appliance from the electricity supply

## Descaling

The water we normally use contains lime. It is a good idea to periodically run a high temperature wash with detergent or use a descaler in the machine. Do this separately from any laundry washing, and according to the manufacturer's instructions. This will help to prevent the formation of lime deposits.

## After each wash

Leave the door open for a while. This helps to prevent mould and stagnant smells forming inside the appliance. Keeping the door open after a wash will also help to preserve the door seal.

## Maintenance Wash

With the use of low temperature washes it is possible to get a build up of residues inside the drum.

We recommend that a maintenance wash be performed on a regular basis.

### To run a maintenance wash:

- \* The drum should be empty of laundry.
- \* Select the hottest cotton wash programme.
- \* Use a normal measure of detergent, must be a powder (such as Ariel Futur).

## External cleaning

Clean the exterior cabinet of the appliance with soap and water only, and then dry thoroughly.

Clean the control panel using a damp cloth only.

 **Do not use abrasives**

## Cleaning the dispenser drawer

From time to time the washing powder and additive dispenser drawer should be cleaned.

Remove the drawer by pulling it out firmly. Flush it out under a tap, to remove any traces of accumulated powder.

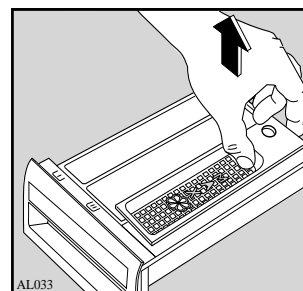
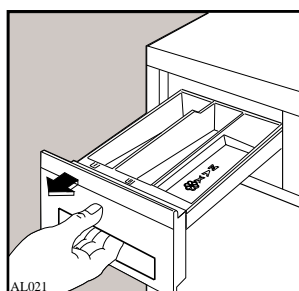

## Cleaning the drawer recess

Having removed the drawer, use a small brush to clean the recess, ensuring that all washing powder residue is removed from the upper and lower part of the recess.

Replace the drawer and run the rinse programme for a few minutes without any clothes in the drum.

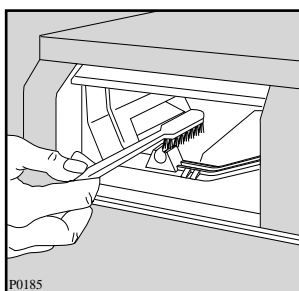

## Cleaning the filter

### The water drain filter

A clean filter is important for the correct functioning of the machine, and should therefore be cleaned after every washing programme.

Open the filter door and place a container underneath to catch any spillage. If the filter is blocked and the machine is unable to drain you will need to drain the water manually from the machine at this stage. To do this, unhook the drain hose from the standpipe or sink and hold the end of the hose over a bowl on the floor. The water should drain by gravity into the bowl. When the bowl is full, hook the hose back up and empty the bowl. Repeat the procedure until water stops flowing out.

Unscrew and remove the filter.

Clean carefully under a fast running tap.

Replace the filter turning now clockwise and tighten it.

### Warning

When the appliance is in use and depending on the programme selected there can be hot water in the filter. Never remove the filter during a wash cycle, always wait until the appliance has finished the cycle, and is empty. When replacing the filter, ensure it is securely retightened so as to stop leaks and young children being able to remove it.

### The water inlet filters

If your water is very hard or contains traces of lime deposit, the water inlet filters may become clogged.

It is therefore a good idea to clean it from time to time.

Turn off the water taps. Unscrew the water inlet hoses. Remove and clean the filters using a hard bristle brush. Replace the filters and tighten up the inlet hoses.

## The dangers of freezing

If the machine is exposed to temperatures below 0°C, certain precautions should be taken.

- Turn off the water taps.
- Unscrew the inlet hoses.
- Unhook the drain hose from the rear support and position the end of this hose and that of the inlet hose in a bowl. Run the draining programme.
- Disconnect the appliance.
- Screw the inlet hoses and reposition the drain hose.
- When you intend to start the machine up again, make sure that the room temperature is above 0°C.

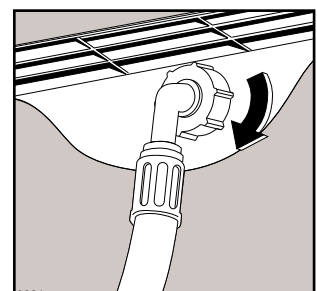
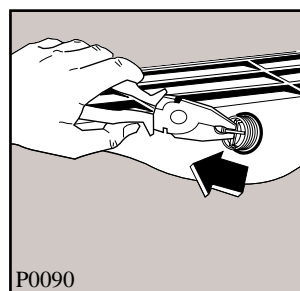
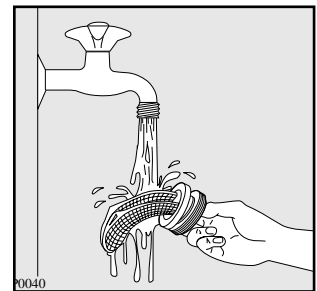
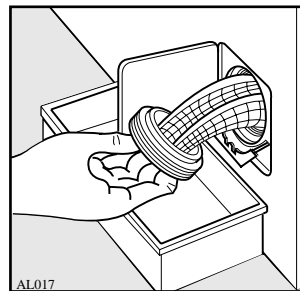
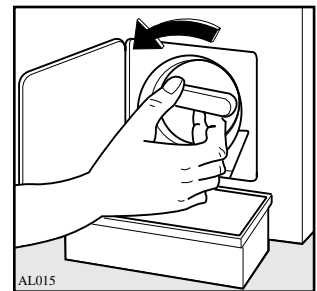
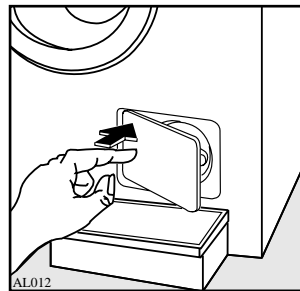

# Something Not Working

Certain problems are due to lack of simple maintenance or oversights, which can be solved easily without calling out an engineer. Before contacting your Zanussi Service Force Centre, please carry out the checks listed below.

**Important:** If you call out an engineer to a fault listed below or to repair a fault caused by incorrect use or installation a charge will be made even if the appliance is in guarantee.

Symptom	Possible causes
<b>The machine does not start</b>	<ul style="list-style-type: none"> <li>■ The door has not been closed.</li> <li>■ The plug is not properly inserted in the power socket.</li> <li>■ There is no current at the socket</li> <li>■ The main fuse has blown.</li> <li>■ The selector dial is not correctly positioned and pulled out</li> <li>■ No water is entering the machine (see: the machine does not fill)</li> </ul>
<b>The machine does not fill</b>	<ul style="list-style-type: none"> <li>■ Ensure the water taps are open and the water supply has not been disconnected</li> <li>■ The filter in the inlet hoses are blocked.</li> <li>■ The inlet hoses may be squashed or kinked.</li> <li>■ The water pressure is too low</li> </ul>
<b>The machine fills then empties immediately</b>	<ul style="list-style-type: none"> <li>■ The end of the drain hose is too low.</li> <li>■ The end of the drain hose is submerged in water.</li> <li>■ There is no vent in the end of the drain hose.</li> </ul>
<b>The machine does not empty and/or does not spin</b>	<ul style="list-style-type: none"> <li>■ The drain hose may be squashed or kinked</li> <li>■ The RINSE HOLD option has been selected.</li> <li>■ The drain filter may be blocked</li> <li>■ The drain hose extension is not correct. Follow the instructions for connecting to the waste.</li> <li>■ The drainage system pipes are blocked.</li> </ul>
<b>There is water on the floor</b>	<ul style="list-style-type: none"> <li>■ Too much detergent or unsuitable detergent has been used (creates too much foam).</li> <li>■ Check whether there are any leaks from one of the inlet hose fittings. It is not always easy to see this as the water runs down the hose; check to see if it is damp.</li> <li>■ The drain hose may be damaged or not securely positioned.</li> <li>■ The detergent dispenser drawer or recess is clogged.</li> <li>■ The drainage system pipes are blocked.</li> </ul>
<b>Unsatisfactory washing results</b>	<ul style="list-style-type: none"> <li>■ Too little detergent or unsuitable detergent has been used. An insufficient amount of detergent leaves the laundry looking grey and causes lime scale to form.</li> <li>■ Stubborn stains have not been treated prior to washing</li> <li>■ The correct temperature to suit the wash programme has not been selected.</li> <li>■ Too much laundry has been placed in the drum.</li> </ul>
<b>The machine vibrates or is noisy</b>	<ul style="list-style-type: none"> <li>■ The internal packing has not been removed.</li> <li>■ The machine is in contact with the wall or furniture.</li> <li>■ The machine is not level.</li> <li>■ The washing load is badly distributed in the drum.</li> <li>■ There is very little laundry in the drum.</li> <li>■ The machine is overloaded</li> </ul>

Symptom	Possible causes
<b>The door will not open</b>	<ul style="list-style-type: none"> <li>■ The programme is still running.</li> <li>■ The door lock has not yet released</li> <li>■ The water level in the drum is too high or the machine is heating.</li> </ul>
<b>Spinning starts late or the machine does not spin</b>	<ul style="list-style-type: none"> <li>■ The electronic unbalance detection device has cut in because the laundry is not evenly distributed in the drum. The laundry is redistributed by reverse rotation of the drum. This may happen several times before the load is evenly distributed and spinning can resume eventually at a lower speed. If the wash load is still not sufficiently distributed, after 10 minutes, the machine will not spin. In this case, redistribute the load manually and reselect the spin programme.</li> </ul>
<b>The machine makes an unusual noise</b>	<ul style="list-style-type: none"> <li>■ The noise produced when spinning may differ from your previous washing machine, which is due to the modern drive system. This new motor ensures a softer start and more even distribution of the laundry in the drum when spinning, as well as increased stability of the machine.</li> </ul>
<b>No water is visible in the drum</b>	<ul style="list-style-type: none"> <li>■ Machines based on modern technology operate very economically using very little water without affecting wash results.</li> </ul>

## Service & Spare Parts

In the event of your appliance requiring service, or if you wish to purchase spare parts, please contact your local Zanussi Service Force Centre by telephoning:-

**0870 5 929929**

Your telephone call will be automatically routed to the Service Force Centre covering your post code area. The addresses are listed on the following pages. Before calling out an engineer, please ensure you have read the details under the heading "Something Not Working."

When you contact the Service Force Centre you will need to give the following details:

1. Your name, address and post code
2. Your telephone number
3. Clear and concise details of the fault
4. The model and serial number of the appliance (found on the rating plate)
5. The purchase date

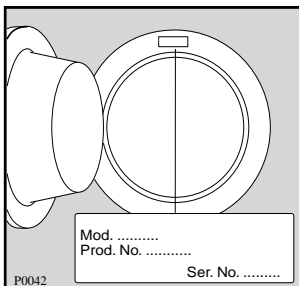

## Customer care

For general enquiries concerning your Zanussi appliance or for further information on Zanussi products, please contact our Customer Care Department by letter or telephone at the address below or visit our website at [www.zanussi.co.uk](http://www.zanussi.co.uk)

Customer Care Department

Zanussi

55-77 High Street

Slough

Berkshire

SL1 1DZ

Tel 08705 727727 \*

\* Calls to this number may be recorded for training purposes

# Guarantee Conditions

## Zanussi standard guarantee conditions

This guarantee is in addition to your statutory and other legal rights.

We, Zanussi, undertake that if, within 12 months of the date of the purchase, this ZANUSSI appliance or any part thereof is proved to be defective by reason only of faulty workmanship or materials, we will, at our option, repair or replace the same **FREE OF ANY CHARGE** for labour, materials or carriage on condition that:

- The appliance has been installed correctly and used only on the electricity supply stated on the rating plate.
- The appliance has been used for normal domestic purposes only, and in accordance with the manufacturer's operating and maintenance instructions.
- The appliance has not been serviced, maintained, repaired, taken apart or tampered with, by any person not authorised by us.
- All service work under this guarantee must be undertaken by a Zanussi service representative or authorised agent

Any appliance or defective part replaced shall become our property.

Home visits are made between **8.30am** and **5.30pm** Monday to Friday. Visits may be available outside these hours in which case a **charge** will be made.

## Exclusions

**This guarantee does not cover:**

- Damage or calls resulting from transportation, improper use or neglect, the replacement of any light bulbs or removable parts of glass or plastic.
- Costs incurred for calls to put right an appliance which is improperly installed or calls to appliances outside the United Kingdom.
- Appliances found to be in use within a commercial environment, plus those which are subject to rental agreements.
- Products of Zanussi manufacture which are NOT marketed by Zanussi.

## Zanussi European guarantee

If you should move to another country within Europe then your guarantee moves with you to your new home subject to the following qualifications:

- The guarantee starts from the date you first purchased your product
- The guarantee is for the same period and to the same extent for labour and parts as exists in the new country of use for this brand or range of products
- This guarantee relates to you and cannot be transferred to another user
- Your new home is within the European Community (EC) or European Free Trade Area
- The product is installed and used in accordance with our instructions and is only used domestically, i.e. a normal household

Before you move please contact your nearest Customer Care Centre, listed below, to give them details of your new home. They will then ensure that the local Service Organisation is aware of your move and able to look after you and your appliances.

France	Senlis	+33 (0)3 44 62 29 99
Germany	Nurnberg	+49 (0)911 323 2600
Italy	Pordenone	+39 (0) 1678 47053
Sweden	Stockholm	+46 (0)8 738 79 50
UK	Slough	+44 (0)1753 219 897

# SERVICE FORCE

**To contact your local Zanussi Service Force Centre telephone 08705 929 929**

<p style="text-align: center;"><b>CHANNEL ISLANDS</b></p> <p><b>GUERNSEY</b>      Guernsey Electricity PO Box 4 Vale, Guernsey Channel Islands GY1 3AD</p> <p><b>JERSEY</b>            Jersey Electricity Company Haut De L'orme Rue De Haut De L'orme Trinity Jersey Channel Islands JE3 5FG</p>	<p><b>ISLE OF LEWIS</b>      ND Macleod 16 James Street Stornoway Isle of Lewis PA87 2QW</p> <p><b>KELSO</b>                2, 6 &amp; 8 Woodmarket Kelso Borders TD5 7AX</p> <p><b>ORKNEY</b>              7 King Street Kirkwall Orkney KW15 1JF</p>	<p style="text-align: center;"><b>NORTH EAST</b></p> <p><b>GATESHEAD</b>        Unit 356a Dukesway Court Dukesway Gateshead NE11 0BH</p> <p><b>GRIMSBY</b>            15 Hainton Avenue Grimsby N. E. Lincs DN32 9AS</p> <p><b>HULL</b>                 Unit 1 Boulevard Industrial Estate Hull HU3 4AY</p> <p><b>LEEDS</b>                64-66 Cross Gates Road Cross Gates Leeds LS15 7YS</p> <p><b>NEWTON AYCLIFFE</b> Unit 23 Northfield Way Aycliffe Industrial Park Newton Aycliffe DL5 6EJ</p> <p><b>SHEFFIELD</b>        Pennine House Roman Ridge Road Sheffield S9 1GB</p>
<p style="text-align: center;"><b>SCOTLAND</b></p> <p><b>ABERDEEN</b>        54 Claremont Street Aberdeen AB10 6RA</p> <p><b>AUCHTERMUCHTY</b> 33a Burnside Auchtermuchty Fife KY14 7AJ</p> <p><b>BLANTYRE</b>         Unit 5 Block 2 Auchenraith Ind. Estate Rosendale Way Blantyre G72 0NJ</p> <p><b>DUMFRIES</b>        93 Irish Street Dumfries DG1 2 PQ</p> <p><b>DUNOON</b>            7 Hill Street Dunoon Argyll PA23 7AL</p> <p><b>EDINBURGH</b>      Unit 12 Dumbryden Ind. Estate 2 Dumbryden Road Edinburgh EH14 2AB</p> <p><b>GLASGOW</b>         Unit 4 Wellington Road Bishopriggs Glasgow G64 2SA</p> <p><b>INVERNESS</b>      Unit 3BI Smithton Ind. Estate Smithton Inverness IV2 7WL</p> <p><b>ISLE OF ARRAN</b>   R Haggerty Bruach Blackwaterfoot Isle of Arran</p> <p><b>ISLE OF BARRA</b>   J Zerfah 244 Bruernish Isle of Barra Western Islands HS9 5QY</p> <p><b>ISLES OF BUTE</b>   Walker Engineering Glenmhor Upper Serpentine Road Rothsay Isle of Bute PA20 9EH</p>	<p><b>PERTH</b>                Scottish Hydro Electric Central Warehouse Inveralmond Perth PH1 3AF (OWN SALES)</p> <p><b>SHETLAND</b>        3-4 Carlton Place Lerwick Shetland ZE1 0PW (OWN SALES)</p> <p><b>SHETLAND</b>        Bolts Shetland 26 North Road Lerwick Shetland ZE1 0PE (OWN SALES)</p> <p><b>WHALSAY</b>         Leask Electrical Harisdale Symbister, Whalsay Shetland ZE2 9AA (OWN SALES)</p>	<p style="text-align: center;"><b>NORTH WEST</b></p> <p><b>BIRKENHEAD</b>      1 Kelvin Park Dock Road Birkenhead CH41 1LT</p> <p><b>CARLISLE</b>         Unit 7 James Street Workshops James Street Carlisle Cumbria CA2 5AH</p> <p><b>ISLE OF MAN</b>     South Quay Ind. Estate Douglas Isle of Man IM1 5AT</p> <p><b>BOLTON</b>            Unit B Central Industrial Estate St Marks Street Bolton BL3 6NR</p> <p><b>PRESTON</b>         Unit 250 Dawson Place Bamber Bridge Preston Lancashire PR5 8AL</p> <p><b>STOCKPORT</b>      Unit 20 Haigh Park Haigh Avenue Stockport SK4 1QR</p>
	<p style="text-align: center;"><b>NORTHERN IRELAND</b></p> <p><b>BELFAST</b>         Owenmore House Kilwee Business Park Dunmurry Belfast BT17 0HD</p>	
	<p style="text-align: center;"><b>WALES</b></p> <p><b>CARDIFF</b>         Unit 4 Guardian Industrial Estate Clydesmuir Road Cardiff CF2 2QS</p> <p><b>CLYWD</b>            Unit 6-7 Coed Parc Abergele Road Rhuddlan Clwyd LL18 5UG</p> <p><b>DYFED</b>             Unit 9 St. Clears Business Park Tenby Road St. Clears Carmarthen SA33 4JW</p> <p><b>OSWESTRY</b>        Plas Ffynnon Warehouse Middleton Road Oswestry SY11 2PP</p>	

# SERVICE FORCE

To contact your local Zanussi Service Force Centre telephone **08705 929 929**

MIDLANDS		LONDON & EAST ANGLIA		SOUTH EAST	
BIRMINGHAM	66 Birch Road East Wyrley Trading Estate Witton Birmingham B6 7DB	BECKENHAM	11a Gardner Ind. Estate Kent House Lane Beckenham Kent BR3 1QZ	ASHFORD	Unit 2 Bridge Road Business Cent Bridge Road Ashford Kent TN23 1BB
BOURNE	Pinfold Road Bourne PE10 9HT	CHELMSFORD	Hanbury Road Widford Ind. Estate Chelmsford Essex CM12 3AE	FLEET	Unit 1 Redfields Ind. Estate Church Crookham Fleet Hampshire GU13 0RD
BRIDGNORTH	68 St. Mary's Street Bridgnorth Shropshire WV16 4DR	COLINDALE	Unit 14 Capitol Park Capitol Way Colindale London NW9 0EQ	HAYWARDS HEATH	21-25 Bridge Road Haywards Heath Sussex RH16 1UA
GLOUCESTER	101 Rycroft Street Gloucester GL1 4NB	ELTHAM	194 Court Road Mottingham Eltham London SE9 4EW	TONBRIDGE	Unit 30 Deacon Trading Estate Morley Road Tonbridge TN9 1RA
HEREFORD	Units 3 & 4 Bank Buildings Cattle market Hereford HE4 9HX	ENFIELD	284 Alma Road Enfield London EN3 7BB	<b>SOUTH WEST</b>	
HIGHAM FERRERS	30 High Street Higham Ferrers Northants NN10 8PL	GRAVESEND	Unit B4 Imperial Business Estate West Mill Gravesend Kent DA11 0DL	BARNSTAPLE	Main Road Fremington Barnstaple North Devon EX31 2NT
ILKESTON	Unit 2 Furnace Road Ilkeston DE7 5EP	IPSWICH	Unit 6C Elton Park Business Centre Hadleigh Road Ipswich IP2 0DD	BOURNEMOUTH	63-65 Curzon Road Bournemouth Dorset BH1 4PW
LEICESTER	Unit 7 Oaks Industrial Estate Coventry Road Narborough Leicestershire LE9 5GF	LETCHWORTH	16-17 Woodside Ind. Park Works Road Letchworth Herts SG6 1LA	BRIDGEWATER	6 Herswell Business Park Salmon Parade Bridgwater Somerset TA6 5PY
LINCOLN	Unit 8 Clifton Street Stone Field Park Lincoln LN5 8LQ	LONDON	2 - 4 Royal Lane Yiewsley West Drayton Middlesex UB7 8DL	BRISTOL	11 Eldon Way Eldonwall Trading Estate Bristol BS4 3QQ
NEWCASTLE UNDER LYME	18-21 Croft Road Brampton Ind. Estate Newcastle under Lyme Staffordshire ST5 0TW	MAIDENHEAD	Reform Road Maidenhead Berkshire SL6 8BY	EMSWORTH	266 Main Road Southbourne Emsworth PO10 8JL
REDDITCH	13 Thornhill Road North Moons Moat Redditch Worcestershire B98 9ND	MOLESEY	10 Island Farm Avenue West Molesey Surrey KT8 2UZ	ISLE OF WIGHT	Unit 8 Enterprise Court Ryde Business Park Ryde Isle of Wight PO33 1DB
TAMWORTH	Unit 3 Sterling Park Claymore Tamworth B77 5DQ	NEWBURY	9 Pipers Court Berkshire Drive Thatcham Berkshire RG19 4ER	NEWTON ABBOT	Unit 2 Zealley Ind. Estate Kingsteignton Newton Abbot TQ12 3TD
WORCESTER	Units 1 & 2 Northbrooks Close Gregorys Mill Ind. Estate Worcester WR3 8BP	NORWICH	2b Trafalgar Street Norwich NR1 3HN	REDRUTH	Unit 7D Pool Ind. Estate Druids Road Redruth Cornwall TR15 3RH
		SUNBURY	Unit 1a The Summit Hanworth Road Sunbury on Thames TW16 5DB		

# Installation Instructions

- ⚠ It is dangerous to alter the specifications or attempt to modify this product in any way.
- ⚠ Care must be taken to ensure that the appliance does not stand on the electrical supply cable.
- ⚠ Any electrical work required to install this appliance should be carried out by a qualified electrician or competent person.
- ⚠ Any plumbing work required to install this appliance should be carried out by a qualified plumber or competent person.

# Technical Specifications

DIMENSIONS	Height Width Depth	85 cm (33.5") 60 cm (23.6") 55 cm (22.7")
POWER SUPPLY VOLTAGE MAX. POWER ABSORBED		230-240 V/50 Hz 2600 W (13A)
WATER PRESSURE	Minimum (cold) Minimum (hot) Maximum	50 kPa (7 psi) 30 kPa (4 psi) 800 kPa (110 psi)
MAXIMUM RECOMMENDED LOAD	Cotton, linen Synthetics Delicate fabrics Wool	4.5 kg (10 lbs) 2 kg (4.5 lbs) 2 kg (4.5 lbs) 1 kg (2.2 lbs)
SPIN SPEED	Maximum	800 rpm



This appliance complies with the following E.E.C. Directives:

- 73/23 EEC of 19.2.73 (Low Voltage Directive) and subsequent modifications;
- 89/336 EEC of 3.5.89 (Electromagnetic Compatibility Directive) and subsequent modifications.



# Unpacking

**⚠ All transit bolts and packing must be removed before using the appliance**

You are advised to keep all the packaging for re-use in case the appliance has to be transported again.

- Unscrew and remove the three rear transit bolts (using a spanner).

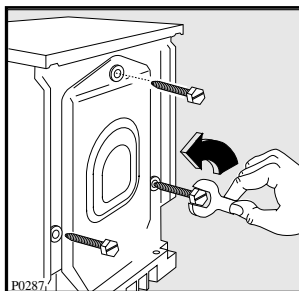

- Lay the machine gently on its back, making sure that the hoses are not squashed.

We suggest a polystyrene angle bracket from the packing is placed on the floor before tilting it back to avoid the hoses being squashed.

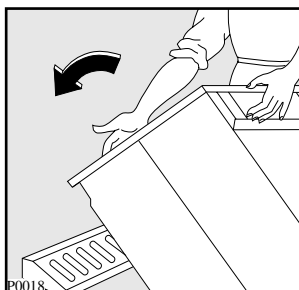

- Carefully remove the polyethylene bags located at the base of the machine by pulling them toward the centre of the machine.

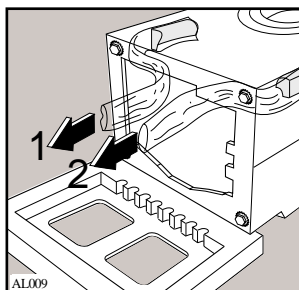

- Place the machine in an upright position and remove the three plastic spacers.

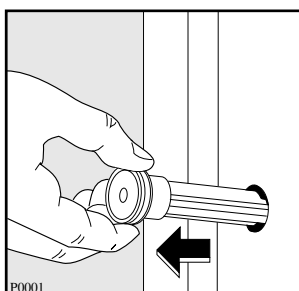

- Plug the 3 holes with the plastic plugs which you can find in the envelope containing the instruction booklet.

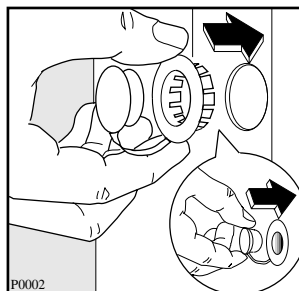

## Positioning

Your new Zanussi washing machine has been designed to be permanently plumbed in to your home's water supply and drainage system. However, if this is not possible, it may be connected to suitable existing taps, with the drain hose discharging into the sink.

The appliance has two inlet hoses, hot and cold, with female 3/4" BSP thread connectors. If this connection is not compatible with the plumbing of the existing installation, a variety of connectors are available from good hardware stores and plumbers merchants to suit most domestic plumbing. Any alterations to your existing plumbing must be carried out by a competent person, or qualified plumber.

## Water inlet

The inlets on the back of the appliance are colour coded, blue for cold and red for hot.

Before connecting the hoses, be sure to fit the black washers supplied (A) as per diagram.

If only a cold water supply is available, connect the two hoses to a cold water outlet by means of a 'Y' connection piece.

Installation should comply with local water authority and building regulation requirements.

The appliance must be given a separate cold water supply and not be connected to a mixer tap, a single outlet water heater or a booster pump. A minimum water pressure of 7psi is required for safe operation of the appliance.

If you cannot make the cold water connection direct from the rising mains, you may be able to operate the appliance from your cold water storage system.

There should be a minimum distance of 5.02m (16 1/2ft) between the appliance's inlet and the bottom of the tank.

There will be sufficient pressure for the hot water supply from the hot water cylinder if the height between the appliance's inlet and the bottom of the cold water storage cistern (not between the appliance and the hot water cylinder) is at least 2.74m (9ft).

Set the hoses correctly by loosening the ring nuts. After positioning the inlet hoses, be sure to tighten the ring nuts again to prevent leaks.

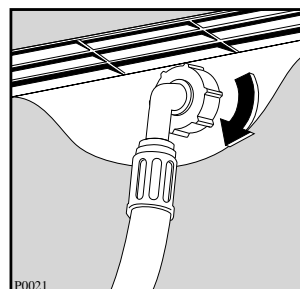
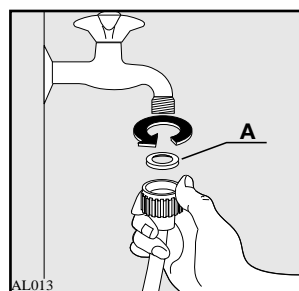
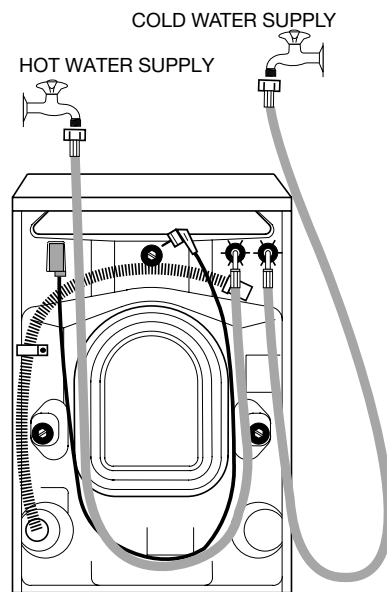

## Water drainage

This appliance is designed to be permanently plumbed into your home's water supply and drainage system.

The appliance drain hose should hook (use the plastic "U-piece" supplied) into a standpipe with an internal diameter of approximately 38mm (see diagram) thus ensuring there is an air break between the drain hose and standpipe.

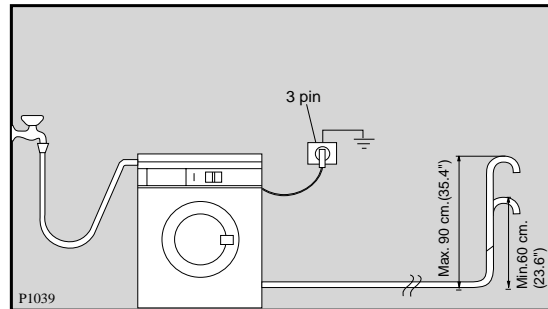

When discharging into a standpipe ensure that the top of the curve in the hose end is no more than 90cm (35.4") and no less than 60cm (23.6") above floor level. The upright standpipe should have a minimum length of 30cm (12") from the bottom of the elbow to the top of the pipe (see diagram).

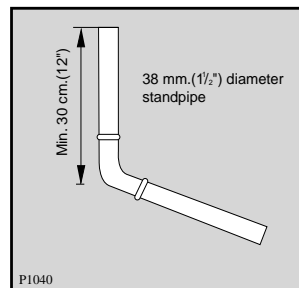

Make sure that it is designed in such a way, that the end of the drain hose cannot be covered with water.

The drain hose may be extended to a maximum of 3 metres. An additional drain hose and joining piece is available from your local Service Force Centre.

The joining piece must have an internal diameter of 18mm.

If you intend the drain hose to empty into a sink, make sure that the sink is empty and the plug hole is not blocked. Use the plastic "U-piece" supplied.

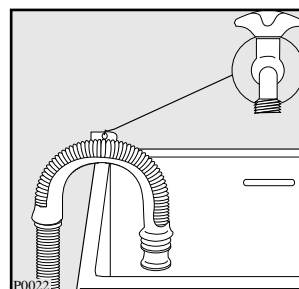

## Levelling

Level the washing machine by loosening or tightening the feet. Once in the right position fix the feet by pushing the nuts against the base of the case

Accurate levelling prevents vibration, noise and displacement of the machine during operation. After levelling the machine, secure the feet by tightening the ring nuts with the aid of a screwdriver.

Some vibration is inevitable, especially if mounted on a wooden floor.

Sprung wooden floors are particularly susceptible to vibration. For advice, consult a builder. If possible, always place the machine on a solid floor.

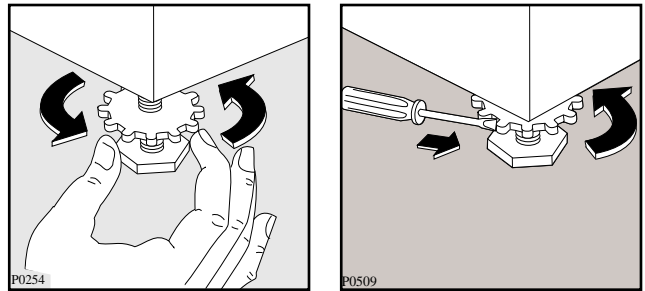

## Special conditions

If the floor is carpeted with a deep-pile carpet or covered with crumbly or soft material, insert a rigid support base under the feet to prevent noise, vibration or displacement. The base should protrude a few centimetres beyond the edges of the machine.



### Warning

The machine should NOT be placed on deep pile carpeting.

### Note

Please ensure that when the appliance is installed it is easily accessible for the engineer in the event of a breakdown.

## In the interest of the environment

Washing machines and dishwashers should be connected to the FOUL drainage system, the water will then be taken to a sewage works for treatment before being discharged safely into a river.

It is essential that these appliances are not connected to the surface water drainage system as this water is discharged directly into a river or stream and may cause pollution.

If you require any further advice please contact your local authority drainage department.

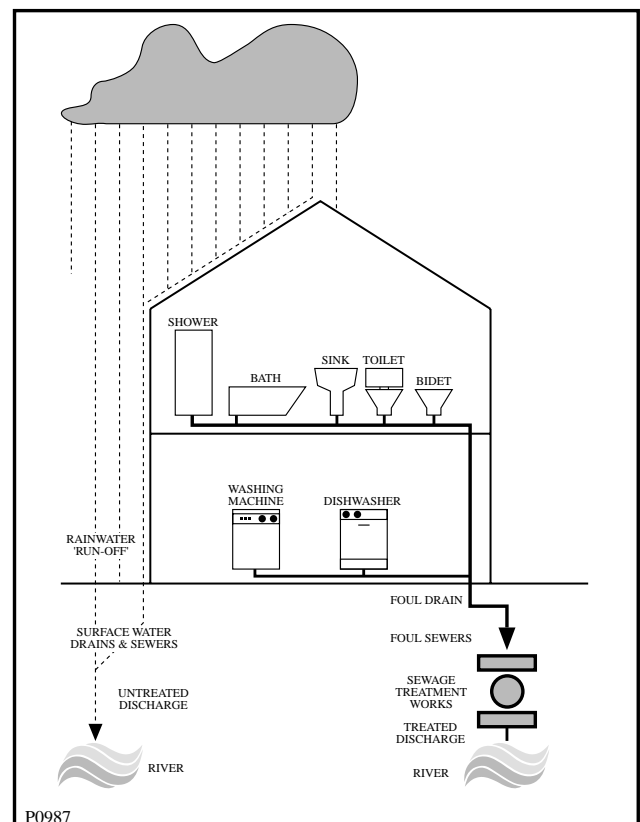

## Electrical connections

Any electrical work required to install this appliance should be carried out by a qualified electrician or competent person

---

**WARNING: THIS APPLIANCE MUST BE EARTHED.**



**The manufacturer declines any liability should this safety measure not be observed.**

---

Before switching on, make sure the electricity supply voltage is the same as that indicated on the appliance rating plate (the plate is stuck to the rear of the appliance).

The appliance is supplied with a 13 amp plug fitted. In the event of having to change the fuse in the plug supplied, use a 13 Amp BS1362 fuse. Only ASTA or BSI approved fuses must be used.

Should the plug need to be replaced for any reason, proceed as described below.

The wires in the mains lead are coloured in accordance with the following code:

Green and Yellow	- Earth
Blue	- Neutral
Brown	- Live

Connect the green and yellow (earth) wire to the terminal in the plug which is marked with the letter «E» or the earth symbol  $\perp$  or coloured green and yellow.

Connect the blue (neutral) wire to the terminal in the plug which is marked with the letter «N» or coloured black.

Connect the brown (live) wire to the terminal in the plug which is marked with the letter «L» or coloured red.

The plug must not be used if the fuse cover/carrier is lost. The cover/carrier is indicated by the coloured insert at the base of the plug.

A replacement cover/carrier must be obtained from your local Zanussi Service Centre, whose address is listed in this instruction manual.

---

**WARNING: a cut off plug inserted into a 13 amp socket is a serious safety (shock) hazard.**



**Ensure that the cut off plug is disposed of safely.**

---

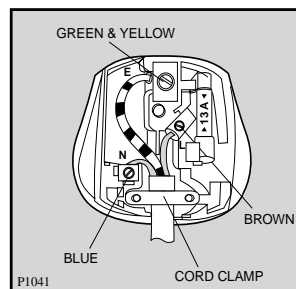

## Permanent connection

In the case of permanent connection it is necessary that you install a double pole switch between the appliance and the electricity supply (mains), with a minimum gap of 3 mm between the switch contacts and of a type suitable for the required load in compliance with the current electrical regulations.

The switch must not break the yellow and green earth cable at any point.





*The Electrolux Group is the world's largest producer of powered appliances for kitchen, cleaning and outdoor use. More than 55 million Electrolux Group products (such as refrigerators, cookers, vacuum cleaners, chain saws and lawn mowers) are sold each year to a value of approx. 14 billion USD in more than 150 countries around the world.*

 **From the Electrolux Group. The world's No.1 choice.**



## Free Manuals Download Website

<http://myh66.com>

<http://usermanuals.us>

<http://www.somanuals.com>

<http://www.4manuals.cc>

<http://www.manual-lib.com>

<http://www.404manual.com>

<http://www.luxmanual.com>

<http://aubethermostatmanual.com>

Golf course search by state

<http://golfingnear.com>

Email search by domain

<http://emailbydomain.com>

Auto manuals search

<http://auto.somanuals.com>

TV manuals search

<http://tv.somanuals.com>