

# ZANUSSI

## WASHING MACHINE FLS 571 C

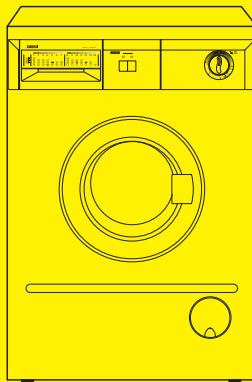

INSTRUCTION BOOKLET



# Important Safety Information

**It is most important that this instruction book should be retained with the appliance for future reference. Should the appliance be sold or transferred to another owner, or should you move house and leave the appliance, always ensure that the book is supplied with the appliance in order that the new owner can get to know the functioning of the appliance and the relevant warnings.**

**These warnings have been provided in the interest of safety. You MUST read them carefully before installing or using the appliance.**

**CHECK THE APPLIANCE UPON RECEPTION AND SHOULD ANY DAMAGE BE OBSERVED CALL YOUR RETAILER BEFORE YOU MAKE IT WORK.**

## Installation

- This appliance is heavy. Care should be taken when moving it.
- It is dangerous to alter the specifications or attempt to modify this product in any way.
- All packing and transit bolts must be removed before use. Serious damage can occur to the product and to property if this is not adhered to. See relevant section in instructions.
- Any plumbing work required to install this appliance should be carried out by a qualified plumber or competent person.
- Any electrical work required to install this appliance should be carried out by a qualified electrician or competent person.
- Care must be taken to ensure that the appliance does not stand on the electrical supply cable.
- If the machine is situated on a carpeted floor, please adjust the feet in order to allow air to circulate freely.
- The washing machine must be unplugged when removing the interior transits bolts. Do not plug the appliance before finishing the removal of the transit bolts and the fixing of the caps in the holes where the security bolts were

## Child Safety

- This appliance is designed to be operated by adults. Children should not be allowed to tamper with the controls or play with the product.
- Pets and children have been known to climb into washing machines. Please check your drum before use.
- The glass door becomes very hot during the washing cycle. Keep children away from the vicinity of the appliance whilst it is in operation.
- Keep all packaging well away for children.
- Keep all detergents in a safe place out of children's reach.

## Use

- Always unplug the appliance and turn off the water after use.
- Do not overload the appliance. See relevant section in instruction book.
- Always look through the glass door to check if water has drained before opening the door before draining the water. If in doubt, refer to your instruction book
- The user should always check that they have not left their gas lighter (disposable or otherwise) in their clothing
- Only wash fabrics which are designed to be machine washed. If in doubt, consult the care label on the clothes.
- Before washing, ensure that all pockets are empty and buttons and zips are fastened. Avoid washing frayed or torn articles and treat stains such as paint, ink, rust, and grass before washing. Underwired bras must NOT be machine washed.
- Any objects such as coins, safety pins, nails, screws, stones or any other hard, sharp material can cause extensive damage and must not be placed into the machine.
- Garments which have been in contact with volatile petroleum products should not be machine washed. If volatile cleaning fluids are used, care should be taken to ensure that the fluid is removed from the garment before placing in the machine.
- Wash small items such as socks, laces, washable belts etc in a washing bag or pillow case as it is possible for such items to slip down between the tub and the inner drum.
- Only use the advised quantities of fabric softener. Damage to the fabric can ensue if you over-fill. Refer to the manufacturer's recommendations of quantities.
- As some duvets and eiderdowns should be washed in large commercial machines because of their bulk, please check with the manufacturer of the item before washing in a domestic machine.
- Leave the porthole door slightly ajar between washes to preserve the door seal.
- Under no circumstances should you attempt to repair the machine yourself. Repairs carried out by inexperienced persons may cause injury or serious malfunctioning. Contact your local Zanussi Service Centre. Always insist on genuine Zanussi spare parts.

# Table of Contents

## For the User

<b>Important Safety Information</b>	2
<b>Description of the Appliance</b>	4
<b>The Control Panel</b>	5
<b>Operating sequence</b>	6-7
Before the first use	6
Load the laundry	6
Measure out the detergent	6
Measure out the additive	6
Select the required programme	7
Start the machine	7
At the end of the programme	7
<b>Washing Programmes</b>	8-9
<b>Washing Hints</b>	10
<b>Wash Care Symbols</b>	11
<b>Maintenance and Cleaning</b>	12-13
Descaling	12
After each wash	12
External cleaning	12
Cleaning the dispenser drawer	12
Cleaning the drawer recess	12
Cleaning the filter	13
The dangers of freezing	13
<b>Something Not Working</b>	14
<b>Service and Spare Parts</b>	14

## For the Installer

<b>Installation Instructions</b>	15
<b>Technical Specifications</b>	15
Unpacking	16
Positioning	17
Water inlet	17
Water drainage	17-18
Levelling	18
Special conditions	18
Electrical connections	19
Permanent connection	19

## Guide to use the Instruction Book

The following symbols will be found in the text to guide you throughout the instructions:



**Safety instructions**



**Hints and tips**

**How do we help to protect the environment?**



**We use recycled paper!**

# Description of the Appliance

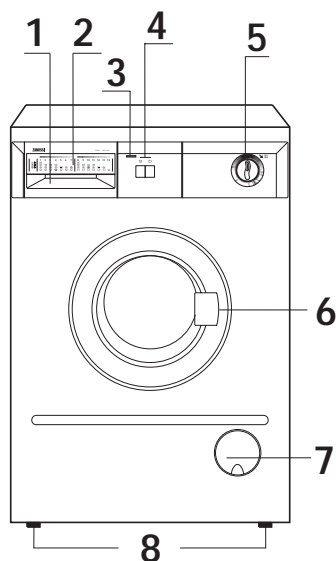
- 1 Detergent dispenser drawer
- 2 Programme guide
- 3 "Mains-on" light
- 4 "Options" buttons
- 5 Program selector dial & ON/OFF switch
- 6 Door opening handle
- 7 Filter
- 8 Adjustable feet



## Detergent dispenser drawer

-  Prewash
-  Wash
-  Fabric softener

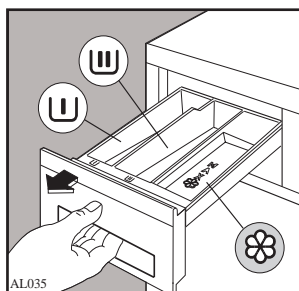

# The Control Panel

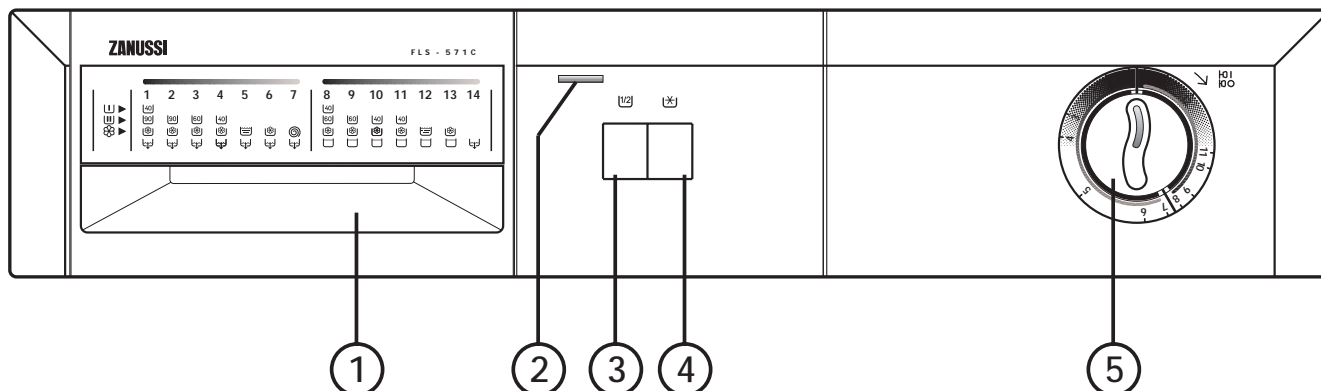

## 1 Programme Guide

## 2 ON/OFF LAMP

It lights when the appliance is operating.

## 3 Half load button

Available only for programmes 1 to 5

Pressing this button before starting the intense program there will be one rinse less which leads to energy and water saving

## 4 Cold Wash button

Pressing this button when starting any program it will be run through with cold water. All other features of the program as intensity and duration remain unchanged. Advisable for synthetic and delicate fabrics: curtains, stores and other not too dirty fabrics

## 5. PROGRAM SELECTOR

To select the required program turn the control clockwise until the marker on the top coincides with the number of the required program (reference mark on the control panel). If at any chance you pass by the required number **NEVER TURN THE CONTROL ANTICLOCKWISE** just continue clockwise until the required number is reached again.

# Operating Sequence

**i** Before your first wash, we recommend that you run a cotton cycle at 60°C, without any laundry in the machine, to remove any manufacturing residue from the drum and tub. Pour 1/2 a measure of detergent into the dispenser drawer and start the machine.

## 1. Load the laundry

Open the door.

Place the laundry in the drum, one item at a time, shaking them out as much as possible.

Close the door.

Do not overload the washing machine, but always try to use it utmost capacity in accordance with the type of fabric. Reduce the quantity when washing very dirty or fluffy laundry.

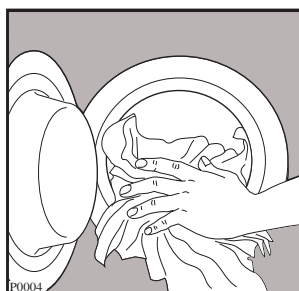

## 2. Measure out the detergent

Pull out the dispenser drawer until it stops.

Measure out the amount of detergent recommended by the manufacturer in a graduated cup and pour it into the main wash compartment **III**.

If you wish to carry out a prewash(\*), pour detergent into the appropriate compartment marked **I**

(\* Prewash is available in programme "1".

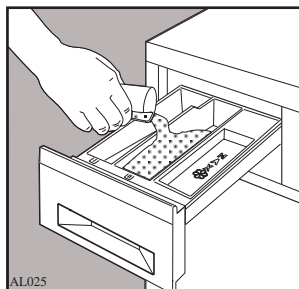

## 3. Measure out the additive

If required, pour fabric softener into the compartment marked **⊗** (the amount used must not exceed the «MAX» mark in the drawer).

Close the drawer gently.

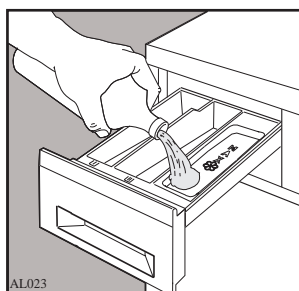

## 4. Select the required programme

Turn the programme selector dial **CLOCKWISE** to the required programme.

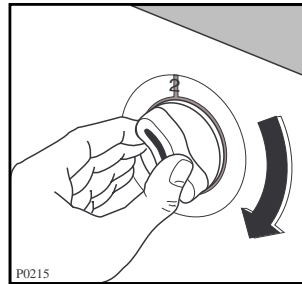

## 5. Start the machine

Before starting up the machine check that:

- the appliance is plugged in
- the water supply tap is turned on
- the door and the detergent dispenser drawer are closed.

Pull the programme selector dial outwards, the operating pilot light will illuminate and the machine will start operating.

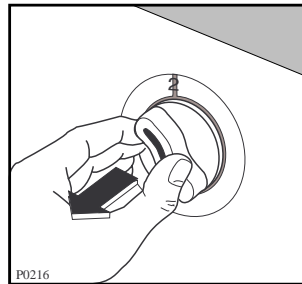

## 6. At the end of the programme

The machine stops automatically and the operating pilot light goes out.

The door is controlled by a safety device which releases 3 minutes after the end of the programme.

**Before opening the door ensure there is no water in the drum.**

Switch the machine off by depressing the programme selector dial.

When the programme has finished, you are advised to unplug the appliance and turn off the water tap.

Leave the door open to prevent the formation of mildew and unpleasant smells.

# Washing Programmes

Programmes for cotton and linen

Maximum load 5 kg

Program. dial position	Program	Temperature °C	Degree of soil	Compartments to use	Description	Possible options
1	Whites with prewash	90°	Heavy soiled		Prewash at 40 °C Wash at 90°C 4 rinses Spin at 500 rpm	
2	Whites without prewash	90°	Normal soiled		Wash at 90°C 4 rinses Spin at 500 rpm	
3 (•)	Fast Coloureds	60°	Normal soiled		Wash at 60°C 4 rinses Spin at 500 rpm	
4	Non Fast Coloureds	40°	Normal soiled		Wash at 40°C 4 rinses Spin at 500 rpm	
5	Rinses				4 rinses Spin at 500 rpm	
6	Additives softener				Load additive 1 rinses Spin at 500 rpm	
7	Spin				Draining of water Spin at 500 rpm	









(•) This 60°C programme is the reference programme for the Energy label according to the article 2, paragraph 1 of the EEC Directive 92/75

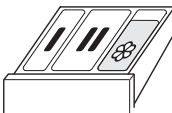

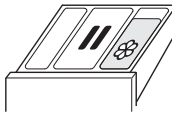
# Washing Programmes

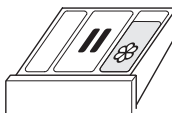
Programmes for synthetics, delicates and wool

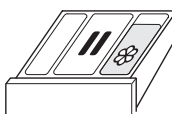
Maximum load 2 kg (wool maximum load 1 kg)

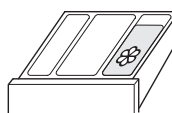
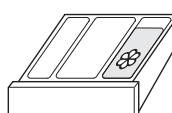
Program. dial position	Program	Temperature °C	Degree of soil	Compartments to use	Description	Possible options
8	Mixed Fabrics	60°	Heavy soiled		Prewash at 40 °C Wash at 60°C 3 rinses <b>Stop with water</b>	
9	Non Fast Coloureds	60°	Normal soiled		Wash at 60°C 3 rinses <b>Stop with water</b>	
10	Synthetics Delicates	40°	Normal soiled		Wash at 40°C 3 rinses <b>Stop with water</b>	
11	Wool Silk	40°	Normal soiled		Wash at 40°C 3 rinses <b>Stop with water</b>	
12	Rinses Delicates				3 rinses <b>Stop with water</b>	
13	Additives Softener				Load additive 1 rinses <b>Stop with water</b>	
14	Drain				Draining of water	

The machine will stop after the last rinse with water in the drum. **To prevent water spillage you must select either Drain (14) or Spin (7) before attempting to open the door.**

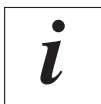

# Washing Hints

Do **NOT** overload the machine. Weigh the laundry the first few times you use the appliance.

The average weights of the most common items are listed below as a guide:

















## 1000g = 1 kg

Sheet	700-1000 g
Pillow case	100-200 g
Tablecloth	400-500 g
Serviette	50-100 g
Tea towel	70-120 g
Linen hand towel	100-150 g
Toweling hand towel	150-250 g
Toweling bath towel	700-1000 g
Bath robe	1000-1500 g
Man's shirt	200-300 g
Apron	150-200 g

- Load the laundry loosely alternating large items with small ones.
- Sort the laundry according to the type of fabric, colour-fastness and how dirty it is.
- Avoid washing unhemmed or torn items as they may unravel.
- Before washing, empty all pockets of small objects which may have been left inside (coins, keys, screws etc). as these could damage the drain pump.
- When washing curtains, remove the hooks.
- Close poppers and zips and fasten loose buttons.
- It is essential to wash new coloured items separately when washing for the first time.
- When washing fabrics requiring different wash temperatures together, always select the lowest temperature.
- White items should not be washed with coloured items.
- Very small items (handkerchiefs, ribbons, socks etc) should be washed in a washing bag or a pillow case.
- Use a good quality detergent suitable for automatic washing machines.
- Use the correct quantities of detergent.
- For wool, use gentle detergent only in small quantities.
- Bleach is very corrosive; it should be used with care and kept out of reach of children.
- Some stains such as fruit, wine, grass, rust etc. are difficult to remove and should be treated before washing with specific products, which can be found in most household shops. In some cases it may help to soak the stain before washing with a special pre-soak product or biological detergent.
- Only wool marked «Pure New Wool - washable, preshrunk» can be washed in the machine using the wool programme; other types of wool should be washed by hand or dry cleaned.
- If you have used the machine to wash, rinse or spin only non-colour fast garments, there may be dye left in the sump. To ensure any subsequent wash is not contaminated with the dye, select and carry out a rinse and spin programme, without any garments, to ensure that any dye is removed from the sump.
- Once you have finished using the machine, you are advised to unplug it and turn off the water tap.
- To avoid an excessive and damaging amount of lather when washing net curtains, it is advisable to wash large curtains singularly and take extra care when measuring the detergent.
- Should an excess of lather accidentally occur, switch off the machine, select the spin programme which is preceded by a drain cycle, to remove the lather and then start the wash again.

# Wash Care Symbols

Wash care labels inside garments recommend how to launder your clothes with the best results. The care labelling code is in line with care labelling used in the rest of Europe. The symbols used make it easy to select the correct programme on your washing machine.

WASHING SYMBOL	WASH ACTION	FABRIC
	Normal (Maximum)	White Cotton or Linen without Special Finishes
	Normal (Maximum)	Cotton, Linen or Viscose without Special Finishes Colour fast at 60°C.
	Reduced (Medium)	Nylon, Polyester/Cotton, Viscose with Special Finishes, Cotton/Acrylic Mix.
	Normal (Maximum)	Cotton, Linen or Viscose Colour fast at 40°C but not 60°C.
	Reduced (Medium)	Acrylics, Acetate, Triacetate, Wool mixes, Polyester/wool blends.
	Much Reduced (Minimum)	Wool, wool mixtures, Silks
	Hand wash only	Do not machine wash
<b>BLEACHING</b>		
	Chlorine bleach may be used	
<b>IRONING</b>		
	Hot iron	Cotton, Linen, Viscose
	Warm iron	Polyester mixtures, Wool
	Cool iron	Acrylic, Nylon, Polyester
<b>DRY CLEANING</b>		
	May be dry cleaned. Other letters and/or a bar beneath the circle will indicate the required process to the dry cleaner.	
<b>TUMBLE DRYING</b>		
	May be tumble dried	
	with high heat setting	
	with low heat setting	
	A cross through any symbol means «DO NOT»	

## Important Notes

For best results, always use the dispenser drawer for dispensing detergents and liquid additives. Once the dispenser has been filled, close it by pushing it in gently. This is particularly important if you are using fabric conditioner to avoid the conditioner entering the machine prematurely.

When using liquid detergent and a prewash programme, place the detergent into the correct compartment in the dispenser drawer, after the prewash has finished.

# Maintenance and Cleaning

**Before any maintenance or cleaning is carried**

**out you must DISCONNECT the appliance from the electricity supply**

## Descaling

The water we normally use contains lime. It is a good idea to periodically use a water softening powder in the machine. Do this separately from any laundry washing, and according to the softening powder manufacturer's instructions. This will help to prevent the formation of lime deposits.

## After each wash

Leave the door open for a while. This helps to prevent mould and stagnant smells forming inside the appliance. Keeping the door open after a wash will also help to preserve the door seal.

## External cleaning

Clean the exterior cabinet of the appliance with soap and water only, and then dry thoroughly.

## Cleaning the dispenser drawer

From time to time the washing powder and additive dispenser drawer should be cleaned.

Remove the drawer by pressing the catch downwards and by pulling it out. Flush it out under a tap, to remove any traces of accumulated powder.

**Keep clean the control panel to avoid liquids to spread in the inside part of the panel**

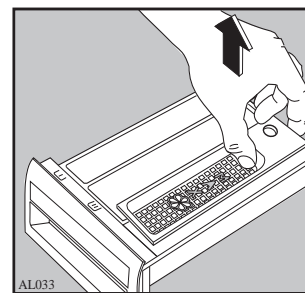
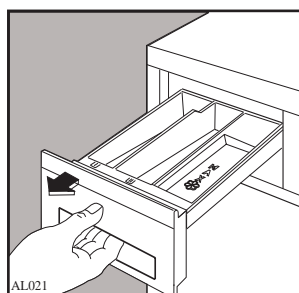

## Cleaning the drawer recess

Having removed the drawer, use a small brush to clean the recess, ensuring that all washing powder residue is removed from the upper and lower part of the recess.

Replace the drawer and run the rinse programme for a few minutes without any clothes in the drum.

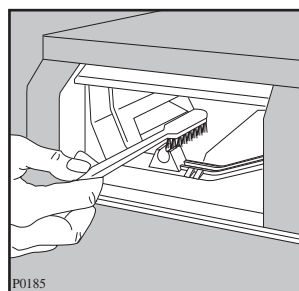

## Cleaning the filter

### The water drain filter

A clean filter is important for the correct functioning of the machine, and should therefore be cleaned after every washing programme.

Open the filter door and place a container underneath to catch any spillage. If the filter is blocked and the machine is unable to drain you will need to drain the water manually from the machine at this stage. To do this, unhook the drain hose from the standpipe or sink and hold the end of the hose over a bowl on the floor. The water should drain by gravity into the bowl. When the bowl is full, hook the hose back up and empty the bowl. Repeat the procedure until water stops flowing out.

Unscrew and remove the filter.

Clean carefully under a fast running tap.

Replace the filter turning now clockwise and tighten it.

#### **Warning**

When the appliance is in use and depending on the programme selected there can be hot water in the filter. Never remove the filter during a wash cycle, always wait until the appliance has finished the cycle, and is empty. When replacing the filter, ensure it is securely retightened so as to stop leaks and young children being able to remove it.

### The water inlet filter

If your water is very hard or contains traces of lime deposit, the water inlet filter may become clogged.

It is therefore a good idea to clean it from time to time.

Turn off the water tap. Unscrew the water inlet hose. Remove and clean the filter using a hard bristle brush. Replace the filter and tighten up the inlet hose.

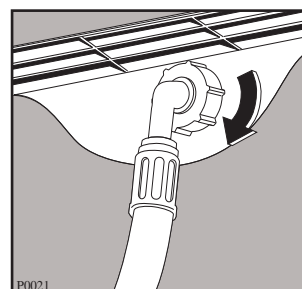
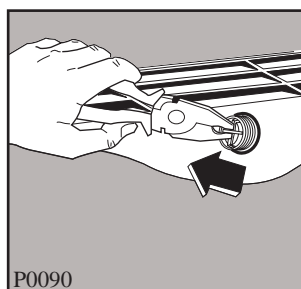
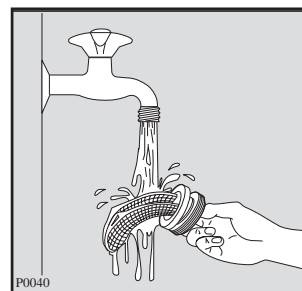
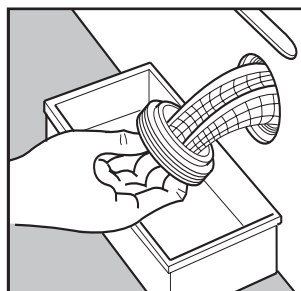
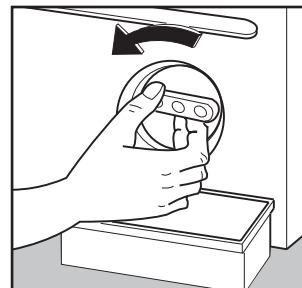
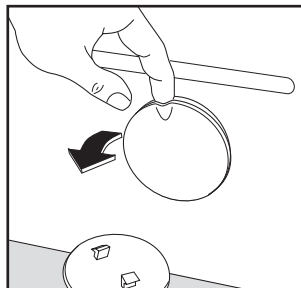

## The dangers of freezing

If the machine is exposed to temperatures below 0°C, certain precautions should be taken.

- Turn off the water tap.
- Unscrew the inlet hose.
- Unhook the drain hose from the rear support and position the end of this hose and that of the inlet hose in a bowl. Run the draining programme.
- Disconnect the appliance.
- Screw the inlet hose and reposition the drain hose.
- When you intend to start the machine up again, make sure that the room temperature is above 0°C.

# Something Not Working

Certain problems are due to lack of simple maintenance or oversights, which can be solved easily without calling out an engineer. Before contacting your Local service Force Centre, please carry out the checks listed below.



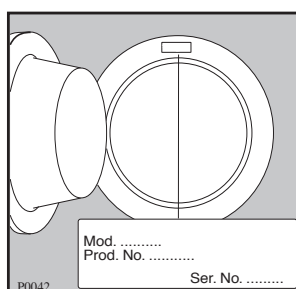

Symptom	Possible causes
<b>The machine does not start</b>	<ul style="list-style-type: none"> <li>■ The door has not been closed.</li> <li>■ The plug is not properly inserted in the power socket.</li> <li>■ There is no current at the socket</li> <li>■ The main fuse has blown.</li> <li>■ The selector dial is not correctly positioned and pulled out</li> <li>■ No water is entering the machine (see: the machine does not fill)</li> </ul>
<b>The machine does not fill</b>	<ul style="list-style-type: none"> <li>■ Ensure the water tap is open and the water supply has not been disconnected</li> <li>■ The filter in the inlet hose is blocked.</li> <li>■ The inlet hose may be squashed or kinked.</li> <li>■ The water pressure is too low</li> </ul>
<b>The machine fills then empties immediately</b>	<ul style="list-style-type: none"> <li>■ The end of the drain hose is too low.</li> <li>■ The end of the drain hose is submerged in water.</li> <li>■ There is no vent in the end of the drain hose.</li> </ul>
<b>The machine does not empty and/or does not spin</b>	<ul style="list-style-type: none"> <li>■ The drain hose may be squashed or kinked</li> <li>■ The drain filter may be blocked</li> <li>■ The drain hose extension is not correct. Follow the instructions for connecting to the waste.</li> <li>■ The drainage system pipes are blocked.</li> </ul>
<b>There is water on the floor</b>	<ul style="list-style-type: none"> <li>■ Too much detergent or unsuitable detergent has been used (creates too much foam).</li> <li>■ Check whether there are any leaks from the inlet hose fittings. It is not always easy to see this as the water runs down the hose; check to see if it is damp.</li> <li>■ The drain hose may be damaged or not securely positioned.</li> <li>■ The detergent dispenser drawer or recess is clogged.</li> <li>■ The drainage system pipes are blocked.</li> </ul>
<b>The machine vibrates or is noisy</b>	<ul style="list-style-type: none"> <li>■ The internal packing has not been removed.</li> <li>■ The machine is in contact with the wall or furniture.</li> <li>■ The machine is not level.</li> <li>■ The washing load is badly distributed in the drum.</li> <li>■ Maybe there is very little laundry in the drum.</li> <li>■ The machine is overloaded</li> </ul>

If after all these checks, the problem persists, contact your local Service Force Centre, quoting the model and serial number. This information can be found on the rating plate (see picture).

Please note that it will be necessary to provide proof of purchase for any in-guarantee service calls. In-guarantee customers should ensure that the above checks have been made as the engineer will make a charge if the fault is not a mechanical or electrical breakdown.



# Installation Instructions

-  It is dangerous to alter the specifications or attempt to modify this product in any way.
-  Care must be taken to ensure that the appliance does not stand on the electrical supply cable.
-  Any electrical work required to install this appliance should be carried out by a qualified electrician or competent person.
-  Any plumbing work required to install this appliance should be carried out by a qualified plumber or competent person.

# Technical Specifications

DIMENSIONS	Height Width Depth	85 cm 60 cm 55 cm
POWER SUPPLY VOLTAGE MAX. POWER ABSORBED		220-230 V/50 Hz 2200 W (10A)
WATER PRESSURE	Minimum Maximum	5 N/cm <sup>2</sup> 80 N/cm <sup>2</sup>
MAXIMUM RECOMMENDED LOAD	Cotton, linen Synthetics Delicate fabrics Wool	5 kg 2 kg 2 kg 1 kg
SPIN SPEED	Maximum	500 rpm

-  This appliance complies with the following E.E.C. Directives:
- 73/23 EEC of 19.2.73 (Low Voltage Directive) and subsequent modifications;
  - 89/336 EEC of 3.5.89 (Electromagnetic Compatibility Directive) and subsequent modifications.

## Unpacking

Before starting the machine up, **the transport security bolts must be removed** as follows:

You are advised to keep all the packaging for re-use in case the appliance has to be transported again.

- Unscrew and remove the three rear transit bolts (using a spanner).

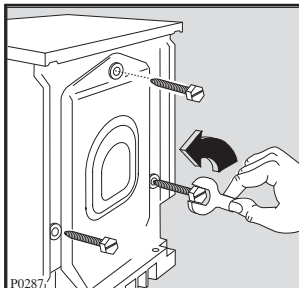

- Lay the machine gently on its back, making sure that the hoses are not squashed.

We suggest a polystyrene angle bracket from the packing is placed on the floor before tilting it back to avoid the hoses being squashed.

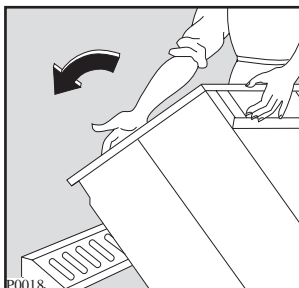

- Carefully remove the polyethylene bags located at the base of the machine by pulling them toward the centre of the machine.

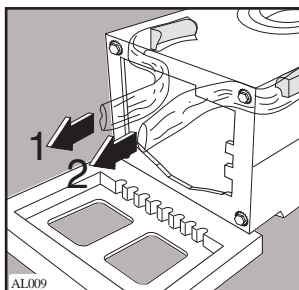

- Place the machine in an upright position and remove the three plastic bolts.

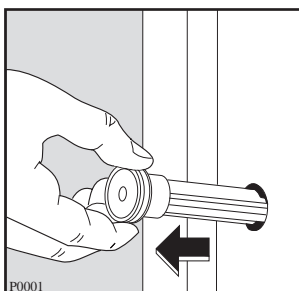

- Plug the 3 holes with the plastic plugs which you can find in the envelope containing the instruction booklet.

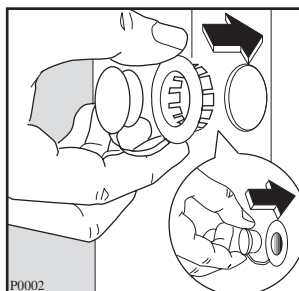



## Positioning

Your new Zanussi washing machine has been designed to be permanently plumbed in to your home's water supply and drainage system. However, if this is not possible, it may be connected to suitable existing taps, with the drain hose discharging into the sink.

## Water inlet

There should be a COLD WATER tap near the washing machine with a screwing on connection pipe of 3/4 gas for the water supply, a sink, a wash basin or a drainage system in the wall.

Previously check if:

- it is not a hot water tap.
- the running water is clean. If not, run off a reasonable amount of water to flush out any debris that may have collected in the pipes.

Have the permanent drainage system in the wall checked by a plumber.

Place the enclosed rubber joint, delivered in a plastic bag together with the appliance (A), at the very end of the inlet hose and carefully screw the pipe to the tap taking care not to damage the screwdriver and fix the nut well on to the end in order to avoid leaking.

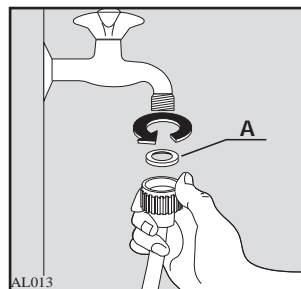

If necessary turn the hose adequately by unscrewing the nut at the rear of the appliance.

Now tighten the nut anew to avoid leaks. (Open the tap and assure that it does not leak and close it again.)

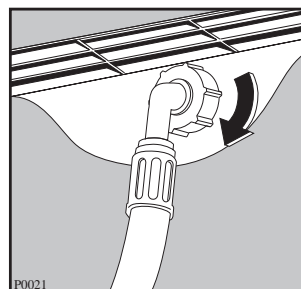

## Water drainage

If you intend the drain hose from the machine to empty into a sink, make sure that the sink is empty and that the plug hole is not blocked.

Place the drain hose in the sink with the aid of the bent piece delivered separately.

The bent piece has to be entered into the tube's mouth in order to assure the support. Aforesaid piece allows the hose to be fixed to the wall by means of an opening on the upper part and that way the hose does not move and its falling is avoided.

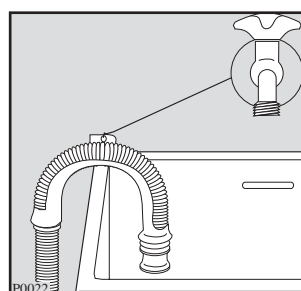

If the machine is permanently plumbed in, hook the end of the hose into a standpipe installed for the purpose. The standpipe must have an internal diameter of at least 40mm in order that there is an air gap between the drain hose and the standpipe. Make sure, that it is designed in such a way, that the end of the drain hose cannot be covered with water.

Whether discharging into a sink or a standpipe check that the end of the drain hose is neither too high nor too low. The top of the curve in the hose's end should be no more than 90 cm, and no less than 60 cm above floor level.

Should a prolongation of the drain hose be unavoidable this must never surpass 1.5 m and must be of the same diameter as the original hose

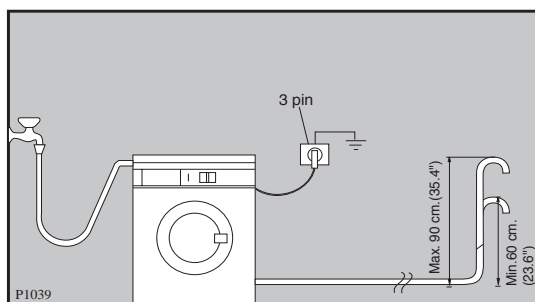

### Important

Before connecting up the machine to new pipework or to pipework that has not been used for some time, run off a reasonable amount of water to flush out any debris that may have collected in the pipes.

### Levelling

Level the washing machine by loosening or tightening the feet. Once in the right position fix the feet by pushing the nuts against the base of the case

Accurate levelling prevents vibration, noise and displacement of the machine during operation. After levelling the machine, secure the feet by tightening the ring nuts with the aid of a screwdriver.

Some vibration is inevitable, especially if mounted on a wooden floor.

Sprung wooden floors are particularly susceptible to vibration. For advice, consult a builder. If possible, always place the machine on a solid floor.

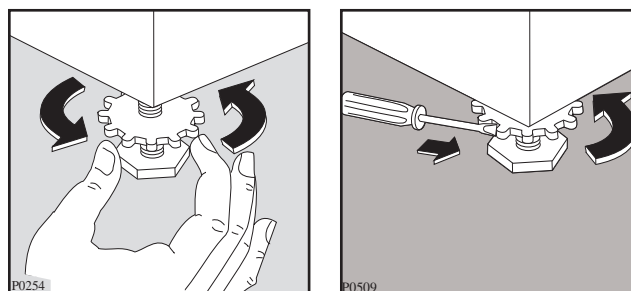

### Special conditions

If the floor is carpeted with a deep-pile carpet or covered with crumbly or soft material, insert a rigid support base under the feet to prevent noise, vibration or displacement. The base should protrude a few centimetres beyond the edges of the machine.



#### Warning

The machine should NOT be placed on deep pile carpeting.

#### Note

Please ensure that when the appliance is installed it is easily accessible for the engineer in the event of a breakdown.

## Electrical connections

Any electrical work required to install this appliance should be carried out by a qualified electrician or competent person

---

**WARNING: THIS APPLIANCE MUST BE EARTHED.**



**The manufacturer declines any liability should this safety measure not be observed.**

---

Before switching on, make sure the electricity supply voltage is the same as that indicated on the appliance rating plate. (the plate is stuck to the rear of the appliance).

The appliance is supplied with a 10 amp plug fitted. In the event of having to change the fuse in the plug supplied, use a 10 Amp fuse.

Should the plug need to be replaced for any reason, proceed as described below.

The wires in the mains lead are coloured in accordance with the following code:

Green and Yellow	- Earth
Blue	- Neutral
Brown	- Live

Connect the green and yellow (earth) wire to the terminal in the plug which is marked with the letter «E» or the earth symbol  $\perp$  or coloured green and yellow.

Connect the blue (neutral) wire to the terminal in the plug which is marked with the letter «N» or coloured black.

Connect the brown (live) wire to the terminal in the plug which is marked with the letter «L» or coloured red.

The plug must not be used if the fuse cover/carrier is lost. The cover/carrier is indicated by the coloured insert at the base of the plug.

A replacement cover/carrier must be obtained from your local Zanussi Service Centre, whose address is listed in the Customer Care Booklet which accompanies your instruction manual

---

**WARNING: a cut off plug inserted into a 10 amp socket is a serious safety (shock) hazard.**



**Ensure that the cut off plug is disposed of safely.**

---

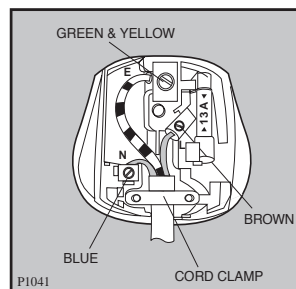

## Permanent connection

In the case of permanent connection it is necessary that you install a double pole switch between the appliance and the electricity supply (mains), with a minimum gap of 3 mm between the switch contacts and of a type suitable for the required load in compliance with the current electrical regulations.

The switch must not break the yellow and green earth cable at any point.



## Free Manuals Download Website

<http://myh66.com>

<http://usermanuals.us>

<http://www.somanuals.com>

<http://www.4manuals.cc>

<http://www.manual-lib.com>

<http://www.404manual.com>

<http://www.luxmanual.com>

<http://aubethermostatmanual.com>

Golf course search by state

<http://golfingnear.com>

Email search by domain

<http://emailbydomain.com>

Auto manuals search

<http://auto.somanuals.com>

TV manuals search

<http://tv.somanuals.com>