

ZANUSSI

 **Electrolux**

WASHING MACHINE ZWC 1300W

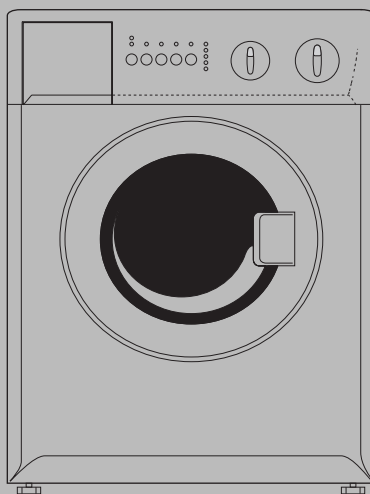

Contents

For the user

Important safety information	3
Disposal	4
Your new washing machine	4
Description of the appliance	5-7
- Machine front, Machine rear	
- Control panel	
Hints & Tips	8
Which detergent?	9
And in which form?	9
Programme chart	10-11
Using the appliance	12-13
- Starting a wash programme	
- Changing a wash programme	
- Interrupting a programme	
- Cancelling a programme	
- Opening the door when the programme has started	
- At the end of the programme	
Maintenance and cleaning	14
- The cabinet	
- The detergent drawer	
- Inside the recess for the detergent drawer	
- Cleaning inside the machine	
- Descaling	
- Protecting the machine against freezing	
Something Not Working	15
Service	16
- Service and spare parts	
- Customer care	
Guarantee Conditions	17

For the installer

Technical specifications	18
Unpacking the machine	19
- If the machine is damaged	
- When lifting the machine	
- Transit locking bolts	
Installation	20-22
- Levelling the machine	
- Water inlet	
- Water drainage	
- Power supply	

Guide to use the instruction book

The following symbols will be found in the text to guide you throughout the instructions:



Safety instructions



Step by step instructions



Hints and tips



Environmental information



Important safety information

Before installing and first using the washing machine, read the instruction booklet carefully, including its hints and warnings. Doing so will ensure that your machine will perform properly and to best advantage. Anyone using the machine should be thoroughly familiar with its instructions for use and safety features. Save these instructions and make sure they remain with the machine if it is moved or sold, so that everyone using it through its life can be properly informed on appliance use and safety.

Installation

- All packaging and transit locking devices must be removed before the machine is first used. If they are not, the result may be damage to the machine or other property. See the section *Transit locking bolts*.
- All installation work and other work done on the product must be carried out by a qualified technician. Work performed by persons with inadequate knowledge may adversely affect the satisfactory functioning of the product and may cause personal injury or damage.
- The machine is heavy, so take care when lifting it. **Never** lift the machine by gripping its control panel, door, or detergent dispenser.
- Make sure that the power cord is not nipped or otherwise damaged and that its hoses do not get crushed or kinked when moving the machine in connection with installation or cleaning etc.
- If the power cable is damaged, it must be replaced by a special cable or assembly available from the manufacturer's service agent.
- Objects such as coins, safety pins, nails, screws and other hard objects can cause serious damage to the machine. Make sure that all pockets have been emptied before putting garments into the machine.
- Remove or pre-treat stains such as rust, dye, ink and grass before machine-washing.
- Avoid washing clothes which are frayed or excessively worn.
- Items which have been treated with chemicals such as stain removal products, liquid domestic cleaning products and similar must be rinsed thoroughly by hand before they can be washed in the machine.
- Wash small items such as thin socks, garment ties/laces, lace items etc. in a special laundry net to prevent them from getting between the inner and outer drums.
- Always follow the recommendations of the manufacturers of detergent and fabric conditioner concerning the quantities of these products to use. Using too much can damage your laundry items.

Child Safety

- The washing machine should be used by adults only. Do not allow children to play with it or touch its controls and moving/movable parts.
- When the machine is operating, the door glass will get hot, so it should not be touched. Keep children away from the machine when it is operating.
- Before loading the machine, check that there are no foreign objects or pets inside the drum.
- Do not overload the drum. Overloading impairs the machine's performance and can damage laundry items.
- Before opening the door always check that the water has been pumped out of the machine.
- Do not leave the premises while the machine is operating.
- After using the machine, turn off its water supply and disconnect it from the power supply. When removing the electrical plug, grip the plug, not the lead.

During Use

- This machine is intended only for normal domestic washing and only in accordance with these instructions. Using it for other purposes could lead to physical injury or damage to property.
- Only machine-washable items should be washed in the machine. If in doubt, contact the manufacturer or retailer of the item.
- Follow the recommendations of the care label, and make sure that pockets are empty and zips and buttons are done up before washing.
- Leave the door ajar when the machine is not in use, to prevent any stale odour.
- Make sure that the machine is disconnected from the power supply during cleaning and maintenance work.
- Servicing and repairs must be carried out by a service company authorised by the manufacturer. Use only spare parts supplied by these. Never try to repair the machine yourself.



Disposal

- the packing material:



Never leave packaging material in a place where children may play with it.

All materials used in packaging this machine are environmentally-friendly. The various plastics used are identified and can be recycled:

- PE stands for polyethylene, which is used for the bag around the machine and the bag in which these instructions were supplied.
- PS stands for polystyrene (in this case moulded polystyrene), which is used for the sections of packaging needed to cushion the machine in transit.

The cardboard components of the packaging are made from recyclable paper and should be taken to a collection point for recycling. The machine contains plastic and rubber components. These have identifying marks to show what they are made from, so they can be recycled or disposed of properly at the end of the machine's life. The materials are identified according to international standards.

- the old appliance:

At the end of the appliance's useful life, disconnect the electrical plug from the power supply, then cut the electrical lead at the point where it enters the appliance. Make quite sure that children will not be able to play with it.



A severed 3 pin plug poses a serious health/shock risk if inserted into a socket. Please dispose of effectively.



Remove or damage the door locking mechanism to prevent a child from becoming trapped inside the machine.

- energy saving tips:

To save water, energy and help protect the environment, we recommend that you follow these hints:

- The washing machine is especially economical when you fully utilise the stated filling quantities.
- Adjust the quantity of washing detergent according to the hardness of the water, the amount of laundry and the degree of soiling.
- A programme without pre-wash is sufficient for normally soiled laundry.
- For small amounts of washing, use only half to two thirds the recommended amount of washing detergent.
- Suitable pretreatment enables stains and small amounts of dirt to be removed. You can then wash at a lower temperature.
- Use the option button "Economy" to wash garments which are lightly to moderately dirty.

Your new washing machine

Your new washing machine meets all modern requirements for effective treatment of laundry with low water, energy and detergent consumption.

- **The programme selector** combines the function of programme and temperature selection, making it easier to set the programme.
- **Programme progress display** shows current phase of the selected programme.
- **The automatic cooling of the washing water** from 90°C to 60°C before draining will reduce thermal shock to fabrics, helping to prevent creasing.

- **The special wool programme** with its new delicate wash system treats your woollens with extreme care.
- **The unbalance detection system** discovers and prevents vibrations caused by incorrect distribution of the laundry during the spin cycle.
- **The ECO valve** makes the full use of detergent possible and saves energy by lower water consumption.

Description of the appliance

Machine front

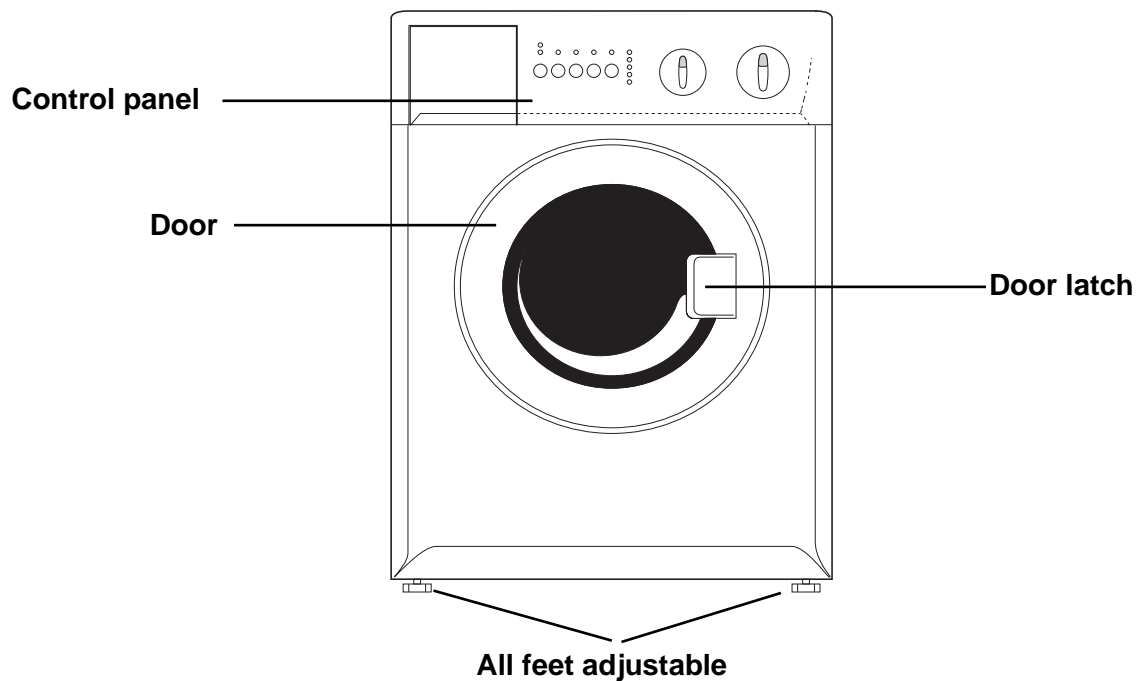

Machine rear

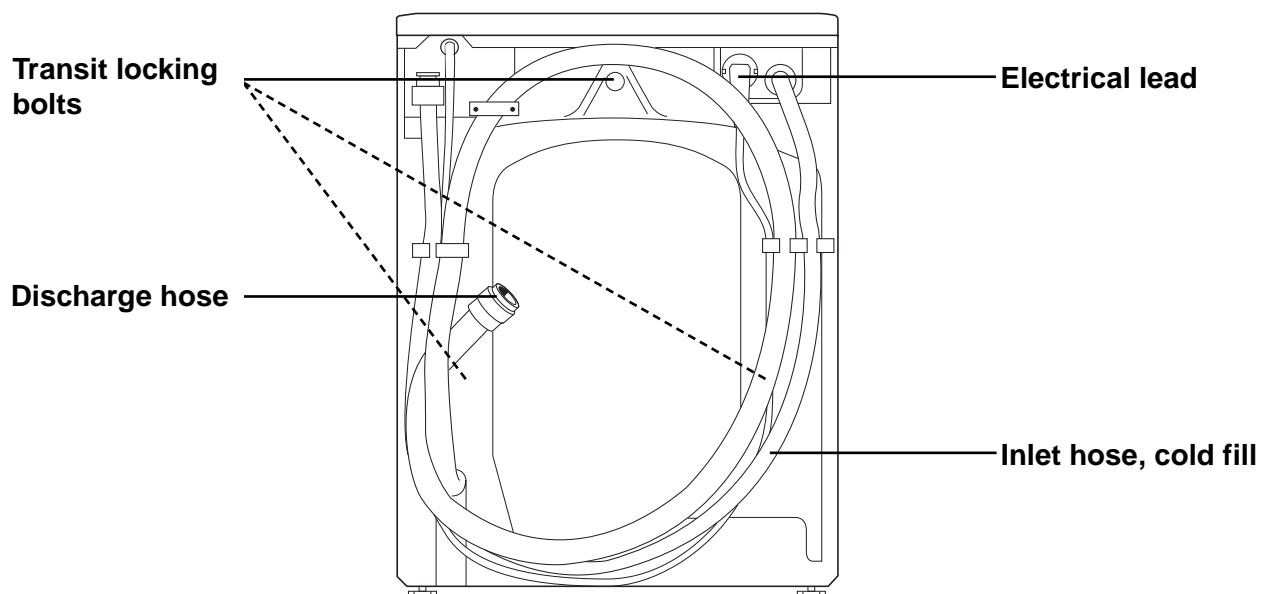

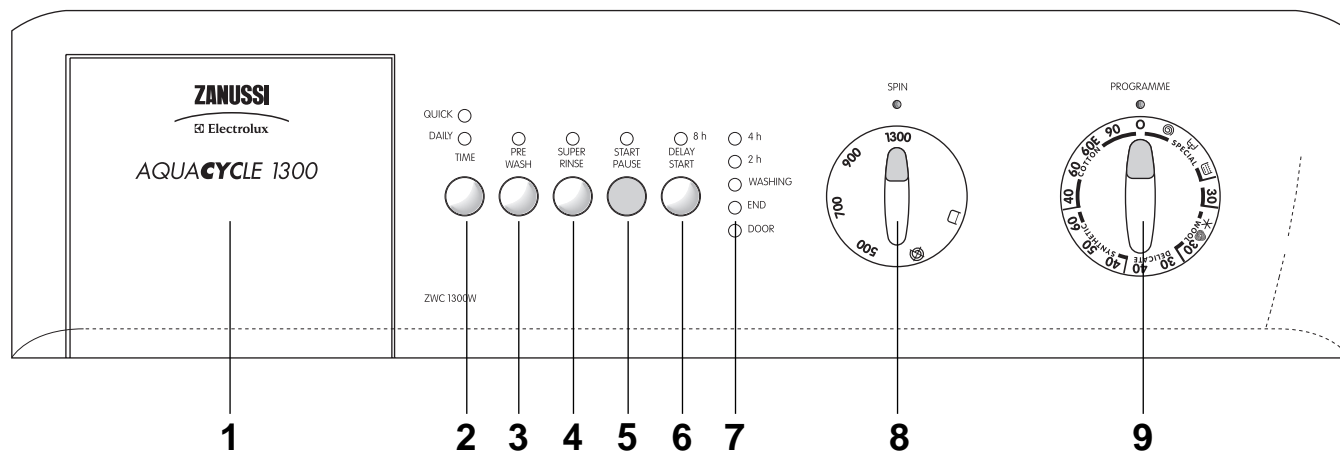

Description of the appliance

Control panel



1 Detergent dispenser

With separate compartments for detergent and fabric conditioner. The detergent is poured in the larger compartment on the left marked with the symbol  and the fabric conditioner in the smaller one on the right marked with the symbol .

i Pre wash detergent is to be added straight into the drum.

Programme option buttons

Depending on the programme, different functions can be combined. They must be selected after the requested programme has been chosen and before depressing the Start/Pause button.

When any of these buttons are depressed, the corresponding indicator lamp comes on. When pressed again, the indicator lamp goes out.

i If an incorrect option is selected, the corresponding indicator lamp flashes for about 2 seconds.

2 Button "Quick" and "Daily"

If you press this button, you can choose between 2 different options. The relevant lamp comes on.

- **Daily:** Short programme for lightly soiled white-/coloured and synthetic laundry. The washing time will be reduced approx. 10 minutes. Max. recommended temperature 60° C.
- **Quick:** Very short programme for lightly soiled laundry, except for wool. The washing time will be reduced approx. 30 minutes for cotton and by 20 minutes for synthetics. The machine will perform 1 rinse less.

i These options can not be chosen together with the economy programme 60E. The washing time will be reduced depending on the type of material and the selected temperature. Recommended load for cotton is 2 kg.

3 Button "Pre wash"

If the laundry is heavily soiled, you can choose a programme with pre wash. Before the main wash the machine then run a pre wash up to 30° C. The washing time will be prolonged approx. 20 minutes.

The pre wash ends with a short spin in the programmes for cotton and synthetic laundry. In the programme for delicate laundry the water is only drained.

i The pre wash option is not available for the wool programme.

4 Button "Super Rinse"

When pressing this button, the machine will perform 2 additional rinses. Can be used with all programmes except for wool.

i Recommended for people with sensitive skin, or in areas with very soft water.

5 Button "Start/Pause"

This button has two functions:

Start: Press the button in order to start the required programme. The corresponding indicator lamp is lit. The indicator lamp for "Door" in the programme progress display is lit and the door is locked.

Pause: To interrupt a programme which is running, press the button. The corresponding indicator lamp starts to flash. To continue the programme, press the button again.

6 Button "Delay Start"

This button makes it possible to delay the starting of the washing programme by 8, 4 or 2 hours. The delay you have selected is indicated by the illumination on of the corresponding light.



You must select this option after you have set the programme and before you press the Start/Pause button.



If you have already pressed the Start/Pause button and you wish to cancel the delay time, proceed as follows:



1. Set the washing machine to Pause by pressing the Start/Pause button.
2. Press the Delay button once, the light relevant to the selected delay goes off.
3. Press in the Start/Pause button again.

Important!

- The selected delay can be changed only after selecting the washing programme again.
- The door will be locked throughout the delay time (door locked light lit).

The Delay start cannot be selected with "Spin"  and "Drain"  programmes.

7 Programme progress display

When you choose the delayed start, the light relevant to the selected delay lights up.

After the machine has started, the remaining time is shown by the corresponding indicator light.

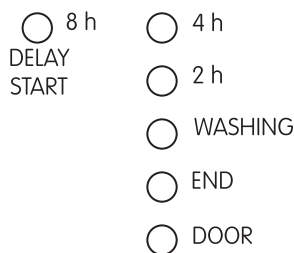

washing: the light comes on when the machine is performing the washing phase (main wash). If you have chosen the "Pre wash" option by pressing that button, the light will be on during the pre-wash phase too.

end: end of programme.

door: the light indicates if the door can be opened:

- the light is lit: the door can not be opened
- the light is out: the door can be opened
- the light flashes: the door can soon be opened

8 Spin speed or function

With this selector you can reduce the final spin speed or select the  "No spin" option. The speeds are applied for the "white-" and "coloured" programmes.

- The position 1300 is equivalent to 900 rpm/min for the synthetic and wool programmes and 700 rpm/min for the delicate wash programme.

- The position 500 is equivalent to 500 rpm/min for the synthetic and wool programmes and 450 rpm/min for the delicate wash programme.





"No spin", by selecting this option all the spinning phases are excluded. To be used for extremely delicate material. The machine will add 3 extra rinses to the cotton programmes and 1 extra rinse to the synthetic programmes.



"Rinse Hold", when selecting this position the water of the last rinse is not drained to prevent the laundry from creasing. The lights "End" and "Door" on the programme progress display are lit when the programme is finished and indicating that the water must be drained before the door can be opened.

To drain the water:



1. Turn the programme selector to the "Reset"  position.
2. Choose the programme "Drain"  or "Spin" . You can reduce the spin speed by turning the selector.
3. Press in the Start/Pause button.

9 Programme selector

The selector is divided into 5 sections:

- Cotton
- Synthetic
- Delicate
- Wool
- Special programmes

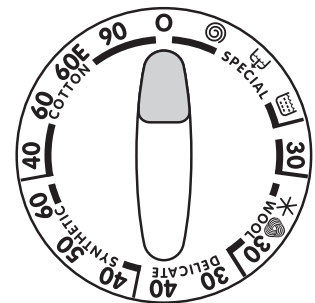

Turn the programme selector clockwise or anticlockwise to select the programme and temperature according to the care label, or one of the special programmes.

 = cold, the water is not heated

 = resets, cancels the programme, switches the machine off.



If you turn the programme selector to an other programme when the machine is working, the lights in the programme progress display starts to flash. The machine will not perform the new selected programme.



When the programme is finished, the programme selector must be turned back to the reset position.

Hints & Tips

For Best Washing Results

- Load the laundry loosely alternating large items with small ones.
- Sort the laundry according to the type of fabric, colour fastness and degree of soilage.
- White items should not be washed with coloured items.
- Wash new coloured items separately when washing for the first time.
- Treat stains such as paint, ink, rust and grass before washing.
- Avoid washing frayed or torn articles.
- When washing fabrics requiring different wash temperatures, always select the lowest temperature.
- Weigh the laundry the first few times you use the appliance.

The average weights of the most common items are listed below as a guide:

1000g = 1kg

Sheet	700-1000 g
Pillow case	100-200 g
Tablecloth	400-500g
Serviette	50-100 g
Tea towel	70-120 g
Linen hand towel	100-150 g
Towelling hand towel	150-250 g
Towelling bath towel	700-1000 g
Bath robe	1000-1500 g
Man's shirt	200-300 g
Apron	150-200 g

Always:

- Empty pockets.
- Ensure buttons and zips are fastened.
- Consult the care label on the garment. Only wash fabrics which are designed to be machine washed.
- Place small items such as socks, laces, handkerchiefs etc in a washing bag or pillow case, as it is possible for such items to slip down between the tub and the inner drum.

Items that should not be put in the machine:

- Underwired bras.
- Garments which have been in contact with volatile or petroleum based products.
- Some duvets and eiderdowns should be washed in large commercial machines. Check with the manufacturer of the item.

































Help the Environment:

To save water, energy and help protect the environment.

- Do not use a pre wash for normally soiled washing.
- Wash full loads.
- Pre-treat stains and then wash at a lower temperature.
- Only use the advised quantities of detergent and fabric softener.

Textile care labelling

These are the commonest symbols used on garments and textiles, plus brief explanations.

normal wash  WASHING  delicate wash	 90° wash 	 60° wash 	 40° wash 	 30° wash 	 hand wash only	 do not wash in water
 BLEACHING	 may be bleached in cold water			 do not bleach		
 IRONING	 ironing max. 200°	 ironing max. 150°	 ironing max. 100°	 do not iron		
 DRY-CLEAN	 dry cleaning in all solvents	 dry cleaning in perchloroethylene, petrol, pure alcohol, R 111 & R 113		 dry cleaning in petrol, pure alcohol and R 113	 do not dry-clean	
 DRYING	 dry flat	 drip dry	 hang-dry	 normal temp.  low temp.	 do not tumble-dry	

Which detergent?

To ensure you obtain the best wash results from your appliance, it is important to use the right detergent in your everyday wash, and only detergents recommended for use in automatic machines.

To maintain the appearance of your clothes and household textiles and to make them last longer you should use different types of detergent for different washes, whether for whites, colours or delicates.

Whites

We recommend the Ariel product range which is biological and designed to provide excellent cleaning and stain removal even at low temperatures.



Non Biological

If you prefer to use a non biological detergent, which does not contain enzymes we recommend Fairy. Fairy provides good cleaning and stain removal.



Coloureds

For coloured items you should use a detergent which is designed to clean while maintaining the original colour. Ariel Color does not contain bleach and therefore helps to preserve colours.



Delicate Items

When washing delicates such as woollens, you should use a product which is specially designed to care to care for fine fabrics. Drefs Automatic is suitable for woollens and other delicates.



Laundry Bleach

For additional stain removal you may wish to use a product such as Ace Gentle Bleach which is used in addition to your chosen detergent. Ace is suitable for all washable fabrics including silks, woollens and coloureds.



And in which form?

Not only are there different types of detergent, but they are also available in different forms. Whether you choose a powder or liquid in traditional or compact form is down to personal choice.

Traditional Powders

Pour the powder directly into the dispenser drawer. Do not sprinkle powder onto clothes in the machine drum.

Traditional Liquids

Liquid can be placed in the main wash compartment of the detergent drawer marked with the symbol , start the machine immediately upon placing the detergent in the dispenser drawer. Alternatively the detergent is measured into the specially designed dosing device which should be placed on top of the laundry and at the back of the machine drum.

Compact Powders and Liquids

Compact detergents (or concentrates as they are also known) are available in liquid or powder form, and generally require a smaller dosage. Follow the manufacturer's instructions to ensure the most economical usage. Pour the detergent directly into the dispenser drawer.

This washing machine has a washing system which uses a minimum amount of water in order to make the laundry clean. It is therefore a risk that the detergent will not dissolve and residues can be found on the garments after the programme is finished if a dosing device is used.



Pre wash detergent is to be added straight into the drum.

Fabric Conditioners

These are ideal for improving 'softness' and also reduce static cling on synthetics and make ironing easier. They are available in two types:

For example Lenor liquid fabric softener, for use in the **washing machine/washer dryer**. The liquid fabric softener should be poured into the compartment marked with the symbol .



Follow the manufacturer's dosage instructions and never exceed the MAX level.

Bounce conditioning sheets for use in a tumble dryer. We recommend the conditioning sheets are pinned (using a safety pin to an article of laundry and placed in the tumble dryer).



Programme chart

Cotton 3.0 kg dry load weight





Synthetics and Delicate 1.5 kg dry load weight

Load type	Temperature °C	Programme content	Option buttons	Consumption *		
				Energy kWh	Water litres	Time minutes
White heavily soiled working clothes, sheets, tablecloths, underwear, towels.	90°	Wash programme 90°C without pre wash. 3 rinses and spin max. 1300 rpm/min.	Quick Daily Pre wash Super rinse Delay start	1,43	44	~ 126
White normally soiled sheets, towels, underwear.	** 60°E	Wash programme 60°C without pre wash. 3 rinses and spin max. 1300 rpm/min.	Pre wash Super rinse Delay start	0,57	39	~ 130
Coloured normally soiled underwear, terry, tablecloths, towels, sheets.	40° 60°	Wash programme 40°, 60°C without pre wash. 3 rinses and spin max. 1300 rpm/min.	Quick Daily Pre wash Super rinse Delay start	0,78	44	~ 107
Synthetic heavily soiled underwear, anti-crease shirts, blouses.	60°	Wash programme 60°C without pre wash. 3 rinses and spin max. 900 rpm/min.	Quick Daily Pre wash Super rinse Delay start	0,57	42	~ 82
Synthetic lightly soiled underwear, anti-crease shirts, blouses.	40° 50°	Wash programme 40°, 50° without pre wash. 3 rinses and spin max. 900 rpm/min.	Quick Daily Pre wash Super rinse Delay start	0,45	42	~ 76
Delicate for fragile items e.g. net curtains.	30° 40°	Wash programme 30°, 40°C without pre wash. 3 rinses and spin max. 700 rpm/min.	Quick Pre wash Super rinse Delay start	0,38	45	~ 61

* The consumption figures can deviate from the stated figures depending on the water pressure, water hardness, inlet temperature, room temperature, type and quantity of laundry, the detergent used, fluctuations in the main voltage and chosen additional functions. The stated figures refers to the highest water temperatures for each wash programme.

** The consumer information on the energy declaration is in accordance with directive EEC 92/75 and refers to the 60E wash programme for cotton.

Wool 1.0 kg and Miniprogram 1,5 kg dry load weight
Special programmes 3.0 kg dry load weight

Load type	Temperature °C	Programme content	Option buttons	Consumption *		
				Energy kWh	Water litres	Time minutes
 Woollens garments with wool-symbol or marked with "Machine washable".	* Cold 30°	Wash programme Cold, 30°C without pre wash. 3 rinses and spin max. 900 rpm/min.	Quick Daily Pre wash Super rinse Delay start	0,20	45	~ 45
Mini for lightly soiled laundry or for laundry which needs freshening up.	30°	Wash programme 30°C without pre wash. 2 rinses and spin max. 700 rpm/min.		0,18	35	~ 30
 Rinses this programme can be used for rinsing hand washed garments.	Cold	3 rinses and spin max. 1300 rpm/min.		0,03	30	~ 27
 Drain emptying the last rinse water in programmes with the rinse hold option.		Draining		-	-	~ 1
 Spin separate spin for hand washed items.		Draining and spin max. 1300 rpm/min.		-	-	~ 5
 Reset		Reset the programme. Switches the machine off.		-	-	-

Using the appliance



Have you removed all the transit locking devices?

The very first time the machine is used, you should run a wash programme without any load, to clear any residues which may have been left by the manufacturing process. Pour approx. 100 ml of detergent straight into the drum and run a programme at 60°C. When the programme is finished, the machine will be ready for use.

Starting a wash programme

Before starting up the machine, check that:

- the door is properly closed
- the appliance is plugged in
- the water supply tap is turned on

To start the machine, proceed as follows:



1. Pull the door latch gently to open the door.

2. Fill the drum evenly with the laundry. Large and small items can be mixed.



Always try to wash full loads: for maximum load weights see the programme charts. You should only reduce the load weight for heavily soiled items and sensitive materials.

3. Close the door.

4. Pull out the dispenser drawer.

5. Measure out the amount of detergent required and pour it into the larger compartment on the left (fig 1).

6. Pour fabric softener into the smaller compartment on the right without exceeding the max. level (fig. 2).

7. Close the drawer.

8. Select the required programme (fig. 3).

9. Turn the spin speed selector to the required position (fig. 4).

10. Select the required option. The corresponding light illuminates (fig. 5).

11. Press the Start/Pause button to start the required wash programme. The indicator lights "Washing" and "Door" comes on and the programme starts.

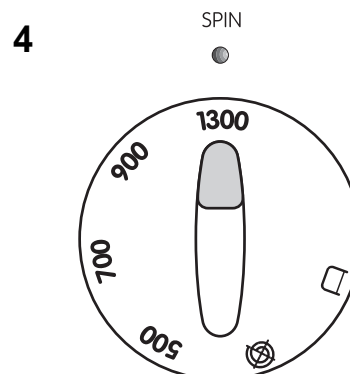
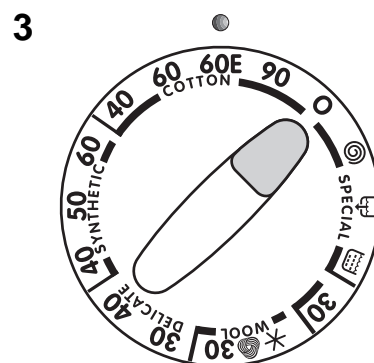
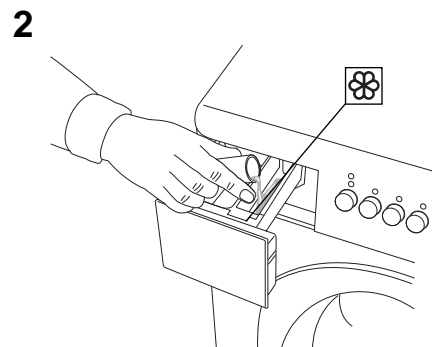
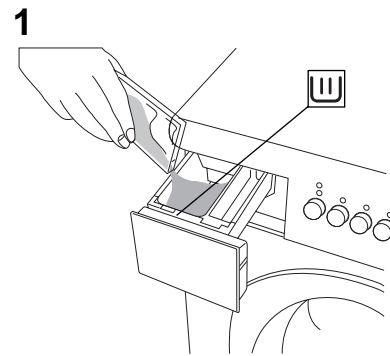

5

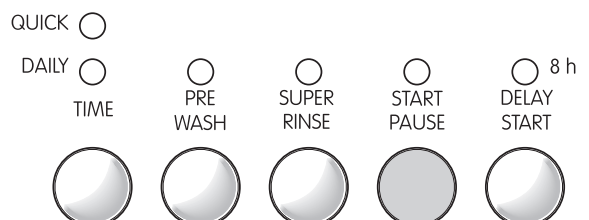

Changing a wash programme

The programme can be changed as long as the Start/Pause button hasn't been depressed. If the programme has started, you can only change it by turning the programme selector to the "Reset" position and cancel the programme. Select a new programme and press the Start/Pause button.



If you turn the programme selector to another programme when the machine is running, the lights in the programme progress display start to flash. The machine will not perform the new selected programme.

Interrupting a programme

Press the Start/Pause button to interrupt a programme which is running. The corresponding light starts to flash. After approx. 1 minute the door can be opened. The programme continues when you press the button again.

Cancelling a programme

Turn the programme selector to the "Reset" position, to cancel a pre-set programme. Now you can select a new programme.

Opening the door when the programme has started

Press the Start/Pause button. The door can be opened after approx. 1 minute, when the following conditions are observed:

- The water temperature is below 55°C.
- The water level is below the bottom edge of the door.
- The machine doesn't spin.

If it's absolutely necessary to open the door and the conditions above have been observed, you must switch the machine off by turning the programme selector to the "Reset" position. After approx. 1 minute can the door be opened.



Pay attention that there can be remaining water in the machine. This could spill out and be hot.

At the end of the programme

The machine stops automatically.

When the "End" light is lit, the programme is finished. The "Door" light goes out, the door can be opened and the laundry can be removed.

If the "Rinse hold" option has been selected, the lights "End" and "Door" continue to be lit to indicate that the water must be drained before opening the door.

To drain the water:



1. Turn the programme selector to the "Reset" position.
2. Select the programme "Draining" or "Spinning". You can reduce the spin speed by turning the selector to avoid synthetic, wool or other fragile materials becoming creased.
3. Press in the Start/Pause button.
4. When the "Door" light goes out, the door can be opened and the laundry can be removed.
5. Turn the programme selector to the "Reset" position.



If you do not intend to carry out any more laundry, turn off the water supply and for safety reasons, also disconnect the power supply to the machine.



Leave the door ajar, so that the remaining moisture inside the drum can evaporate and prevent any musty smells developing.

Maintenance and cleaning

The cabinet

Clean the outside surfaces of the machine using a mild solution of washing up liquid and water. Finish by removing remaining traces of the product with a damp cloth.

The detergent drawer

In time, residues of detergent and fabric conditioner are likely to build up inside the detergent drawer. It should be cleaned at regular intervals by flushing it out with water. If necessary, the whole drawer can be taken out of the machine for cleaning. Pull the drawer out as normal until it stops at the retaining stop. With a hand each side of the body of the drawer and with care, give the drawer a sharp tug towards you so it becomes free of the retaining stop (Fig. 1).

To remove the syphon (at the inside edge of the drawer) for cleaning, you need to press it inwards and pull it upwards at the same time (Fig. 2). When you put it back, press it downwards until you hear a distinct click.

Inside the recess for the detergent drawer

Detergent residues can also build up inside the recess for the detergent drawer. You can use an old toothbrush for cleaning this area (Fig. 3). When you have finished and put back the drawer, run a short programme with no wash load in the machine to rinse it clean.

Cleaning inside the machine

If you mostly use your machine for low-temperature washes and/or if you use only very little detergent, you should clean the inside of the machine about once a month. This will prevent mould or stale odours from developing.

Use a normal measure of detergent, must be a biological powder (such as Ariel Futur) and run a wash programme at the highest temperature with no wash load in the machine.

Descaling

If your water supply is harder than 7° dH, you should descale your washing machine at least once every three months. Use approx. 150 ml of citric acid instead of detergent and run a wash programme at the highest temperature with no wash load in the machine. Limescale deposits on components such as the machine's heating element will reduce their service life. (Contact your water company to find out the hardness level of your local water supply).

Protecting the machine against freezing

If the machine is kept in a place where the temperature may sometimes falls below 0° C, there is a risk that the small amount of water which remains inside parts of the machine after normal use will freeze and damage it.

To prevent this you should:

1. Turn off the water supply and disconnect the water inlet hose from the supply tap.
2. Select a wash programme, start the machine and let the programme run for a short time.
3. Interrupt the programme by turning the programme selector to the "Reset" position.

4. Place the end of the inlet and discharge hoses down low, into the waste gully (floor drain) set into the floor. Make sure that the end of the hose does not go below the water level in the gully's (drain's) water trap.
5. Select the programme "Drain" and let that run until it is finished.
6. Turn the programme selector to the "Reset" position.

The appliance is only to be used and stored indoors at normal room temperature. The manufacture is not responsible for any frost damage.

 **Do not use cleaning products which contain alcohol (spirits), thinners and similar substances.**

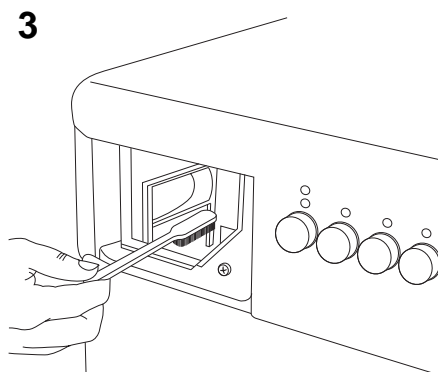
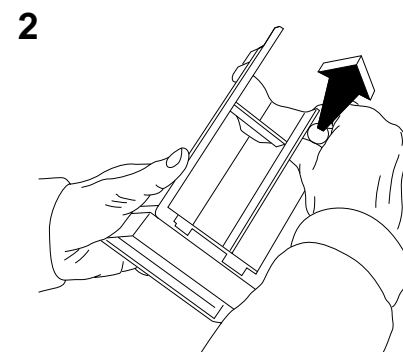
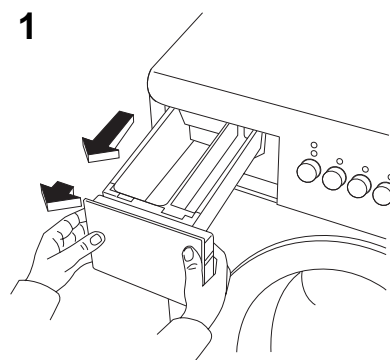

Something Not Working

Before calling out an engineer, please check through the details below because some faults can be rectified easily without the need to call out an engineer. If an engineer is called to resolve a problem listed below or to repair a fault caused by incorrect installation or mis-use a charge will be made, even if the appliance is under guarantee.

Fault	Check
The machine will not start.	<ul style="list-style-type: none"> • Is the door closed properly? • Have you pressed the Start button? • Is the water tap turned on? • Is the machine plugged in? • Has the fuse blown? (Check the fuse in electrical plug and on the household circuit board). • Have you set the programme selector properly?
The machine is not filling with water.	<ul style="list-style-type: none"> • Is the water tap turned on? • Has your domestic water supply been cut off temporarily? • Is the water inlet hose kinked or blocked? • Is the filter inside the inlet hose blocked? • Is the water pressure too low?
The machine is discharging water at the same time as filling.	<ul style="list-style-type: none"> • Is the end of the discharge hose too low down? (See Installation) • Is there a proper air gap between the end of the discharge hose and the wall standpipe? (See Installation)
The machine will not empty or spin.	<ul style="list-style-type: none"> • Did you select a programme without drain and spin? • Is the discharge hose kinked or constricted? • Have any extensions to the outlet hose been done correctly? (See Installation).
The machine is leaking or overflowing.	<ul style="list-style-type: none"> • Have you used too much detergent? • Have you been using the detergent for automatic machines? • Are both hoses correctly installed? (See Installation) • Is the detergent compartment blocked?
The machine is vibrating or noisy.	<ul style="list-style-type: none"> • Have you removed all three transit locking bolts? • Has the machine been installed on a suitable surface and levelled? • Is the machine knocking against a wall? • Is the machine standing firmly on all four feet? • Is the load level/balanced?
The machine door will not open.	<ul style="list-style-type: none"> • Did you wait approx. 1 minute after that the programme had finished and has the indicator light for locked door gone out? Read the chapter "Maintenance" on door opening. Never try to force the door open. Contact your local Service Force Centre.
Spinning starts late or the machine does not spin.	<ul style="list-style-type: none"> • The electronic unbalance detection system has cut in because the laundry is not evenly distributed in the drum. The laundry is redistributed by reverse rotation of the drum. This may happen several times before the unbalance disappears and normal spinning can resume. If, after 10 minutes, the laundry is still not evenly distributed in the drum, the machine will not spin. In this case, redistribute the load manually and select the spin programme.
The "End" indicator light flashes: 1 flash = the machine does not fill 2 flashes = the machine will not drain 4 flashes = the door is opened	<ul style="list-style-type: none"> • Is the water tap turned on? • Is the filter inside the inlet hose blocked? • Is the discharge hose kinked or constricted? • Is the door closed properly?

Service and Spare Parts

In the event of your appliance requiring service, or if you wish to purchase spare parts, please contact your local Service Force Centre by telephoning:

08705 929929

Your telephone call will be automatically routed to the Service Force Centre covering your post code area.

For the address of your local Service Force Centre and further information about Service Force, please visit the website at www.serviceforce.co.uk

For Customer Service in Ireland please contact us at the address below:

Zanussi Electrolux
Electrolux Group (Irl) Ltd
Long Mile Road
Dublin 12
Republic of Ireland
Tel: + 353 (0)1 4090751
Email: service.eid@electrolux.ie

Before calling out an engineer, please ensure you have read the details under the heading "Something Not Working".

When you contact the Service Force Centre you will need to give the following details:

1. Your name, address and post code
2. Your telephone number
3. Clear and concise details of the fault
4. The model and serial number of the appliance (found on the rating plate)
5. The purchase date

Please note that a valid purchase receipt or guarantee documentation is required for in-guarantee service calls.

Customer Care Department

For general enquiries concerning your Zanussi Electrolux appliance or for further information on Zanussi Electrolux products, please contact our Customer Care Department by letter or telephone at the address below or visit our website at www.zanussi.co.uk

Customer Care Department
Zanussi Electrolux
55-77 High Street
Slough
Berkshire
SL1 1DZ
Tel: 08705 727727 *

* call to this number may be recorded for training purposes.

Guarantee Conditions

Standard guarantee conditions

We, Zanussi Electrolux, undertake that if within 12 months of the date of the purchase this ZANUSSI ELECTROLUX appliance or any part thereof is proved to be defective by reason only of faulty workmanship or materials, we will, at our option repair or replace the same FREE OF CHARGE for labour, materials or carriage on condition that:

- The appliance has been correctly installed and used only on the electricity supply stated on the rating plate
- The appliance has been used for normal domestic purposes only and in accordance with the manufacturer's instructions
- The appliance has not been serviced, maintained repaired, taken apart or tampered with by any person not authorised by us
- All service work under this guarantee must be undertaken by a Zanussi Electrolux Service Force Centre
- Any appliance or defective part replaced shall become the Company's property
- This guarantee is in addition to your statutory and other legal rights

Home visits are made between **8.30am** and **5.30pm** Monday to Friday. Visits may be available outside these hours in which case a premium will be charged.

Exclusions

This guarantee does not cover:

- Damage or calls resulting from transportation, improper use or neglect, the replacement of any light bulbs or removable parts of glass or plastic
- Costs incurred for calls to put right an appliance which is improperly installed or calls to appliances outside the United Kingdom
- Appliances found to be in use within a commercial environment, plus those which are the subject to rental agreements
- Products of Zanussi Electrolux manufacture which are not marketed by Zanussi Electrolux

European Guarantee

If you should move to another country within Europe then your guarantee moves with you to your new home subject to the following qualifications:

- The guarantee starts from the date you first purchased your product
- The guarantee is for the same period and to the same extent for labour and parts as exists in the new country of use for this brand or range of products
- This guarantee relates to you and cannot be transferred to another user
- Your new home is within the European Community (EC) or European Free Trade Area
- The product is installed and used in accordance with our instructions and is only used domestically, i.e. a normal household
- The product is installed taking into account regulations in your new country

Before you move please contact your nearest Customer Care centre, listed below, to give them details of your new home. They will then ensure that the local Service Organisation is aware of your move and able to look after you and your appliances.

France	Senlis	+33 (0)3 44 62 29 99
Germany	Nurnberg	+49 (0)800 234 7378
Italy	Pordenone	+39 (0)0434 39 4700
Sweden	Stockholm	+46 (0)8 672 53 90
UK	Slough	+44 (0)1753 219897
Ireland	Dublin	+353 (0)1 4090751

Installation instructions

 Any electrical work required to install this appliance should be carried out by a qualified electrician or competent person.

 Any plumbing work required to install this appliance should be carried out by a qualified plumber or competent person.

Technical specifications

DIMENSIONS	Height	67 cm
	Width	49.5 cm
	Depth	51.5 cm
WEIGHT	Net	54 kg
RECOMMENDED CAPACITY (DRY WEIGHT)	Cotton	3.0 kg
	Synthetics/Delicate	1.5 kg
	Wool	1.0 kg
WATER PRESSURES	Minimum	50 kPa (0.5 bar)
	Maximum	1000 kPa (10 bar)
DRUM VOLUME		27 litres
SPIN SPEED	Maximum	1 300 rpm
ELECTRICAL DATA	Power supply	230 V - 50 Hz
	Fuse	13 A
	Power rating	1600 W



This appliance complies with the requirements of the following EU directives:

- 73/23/EEC, dated 19.02.1973 – low-voltage directive.
- 89/336/EEC, dated 03.05.1989 (incl. amendment 92/31/EEC) – directive on electromagnetic compatibility.

Unpacking the machine

If the machine is damaged

If the machine has been damaged during transportation, you should immediately notify the company responsible for delivering it.

Check that the washing machine is undamaged. If you discover any damage, faults or that anything is missing, you should notify the seller immediately.



Never leave packaging material in a place where children may play with it.

When lifting the machine

Take care when lifting the machine. Incorrect methods of lifting can cause physical injuries, and also increase the risk of damage to the machine. Open the door and take hold of it inside the top of the door opening. You can also grasp the rear overhang of the machine top to lift this machine.



Never lift the machine by gripping its control panel, the door itself, or its detergent drawer (Fig. 1).

Transit locking bolts

When supplied the washing machine is packed using a number of locking devices/packing pieces to prevent drum and motor from damage in transit. These must all be removed before the washing machine is installed.



1. Spread some of the polystyrene packaging materials on the floor behind the machine and then lay the machine carefully rearside down on them.



Make sure that no hoses are crushed in the process (Fig. 2).

2. Remove the polystyrene base and the support bar which the machine rests on.
3. Return the machine to its normal upright position and remove the three bolts and their spacers on its rear (Fig. 3).
4. The three holes must then be plugged with the plastic plugs supplied, which can be found in a plastic bag inside the drum (Fig. 4).

1

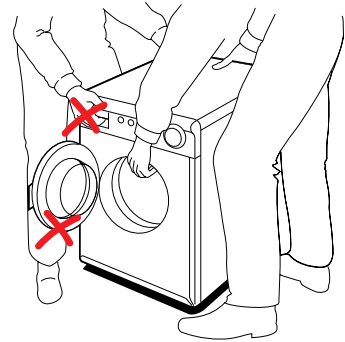

2

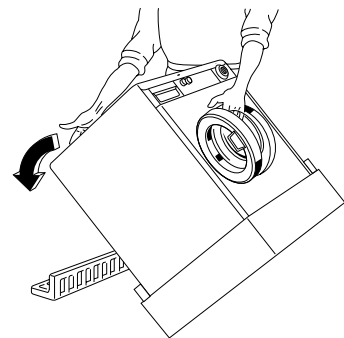

3

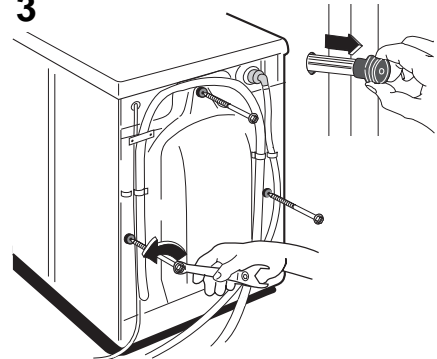

4

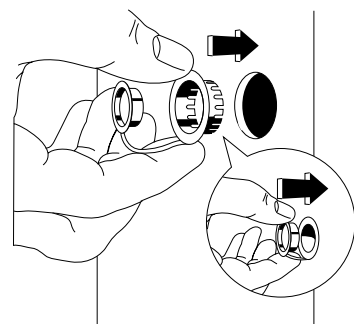

Installation

The machine must be installed on a sound and firm surface and must not be touching walls or furniture.

Levelling the machine

Adjust the feet to level the machine. Make sure the machine is standing on all four feet. Accurate levelling prevents vibration, noise and displacement of the machine during operation. (Fig. 1).

Some vibration is normal and unavoidable when the machine is spinning the load, especially if mounted on a wooden floor.

Sprung wooden floors are particularly susceptible to vibration. For advice, consult a builder. If possible, always place the machine on a solid floor.

 **When the appliance location is on carpet floors, attention must be paid so as to ensure that there is no obstruction to the bottom vents.**

Water inlet

Connect the inlet hose to a tap with a 3/4" pipe thread (Fig. 2).

The inlet hose must not be joined onto any form of extension hose. If it is too short, the entire hose must be replaced with a longer high-pressure hose, specially designed for the purpose. These are available from your local Service Force Centre.

The machine end of this hose can be turned in any direction. Loosen the retaining nut, turn the hose, then retighten the nut (Fig. 3).

 **Check that the nut is tightend before the machine is moved into position.**

 **Use only the inlet hose supplied with the machine, do not reuse the old inlet hose.**

1

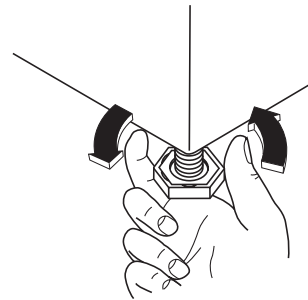

2

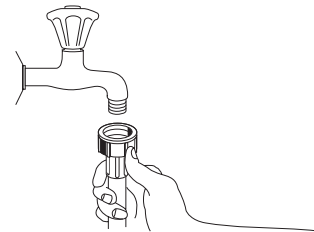

3

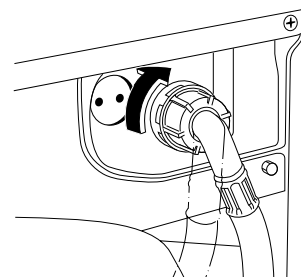

Water drainage

If you intend the drain hose from the machine to empty into a sink, make sure that the sink is empty and that the plug hole is not blocked.

If the machine is permanently plumbed in, hook the end of the hose into a standpipe installed for the purpose. The standpipe must have an internal diameter of at least 40 mm (1 1/2") in order that there is an air gap between the drain hose and the standpipe. Make sure, that it is designed in such a way, that the end of the drain hose cannot be covered with water.

Important

Before connecting up the machine to new pipework or to pipework that has not been used for some time, run off a reasonable amount of water to flush out any debris that may have collected in the pipes.

Whether discharging into a sink or a standpipe, check that the end of the drain hose is neither too high or too low. The top of the curve in the hose's end should be no more than 800 mm (31.5"), and no less than 650 mm (25.6") above floor level.

The discharge hose can be extended up to a total of 3,5 m. For the extension piece use a hose with an internal diameter at least as large as that of the machine's own hose. Use a suitable hose connector.



In order for the machine to function properly, the drain hose must be hooked on the factory fitted support piece situated on top of the back side of the appliance.

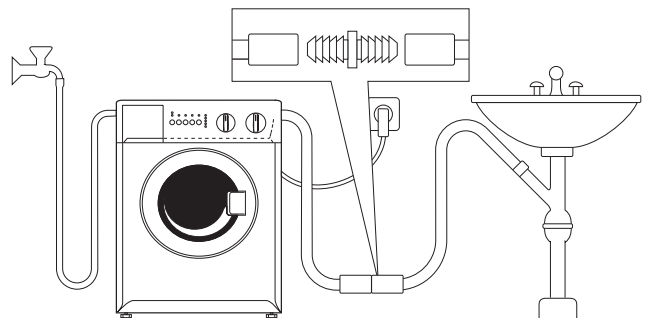
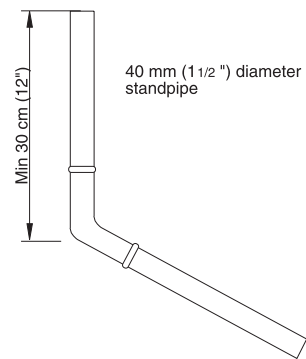
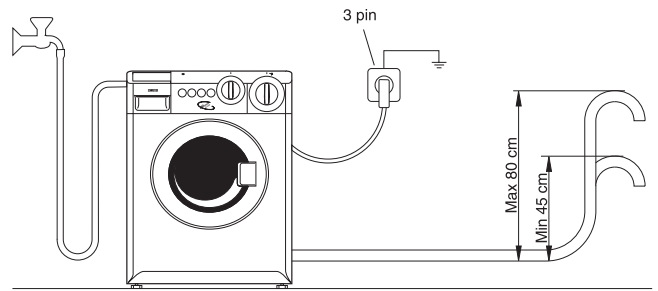

Electrical installation

Power supply

The washing machine is supplied with a lead and electrical plug for connection to a 230 V, 13 A earthed wall socket. Before any work is carried out on the washing machine, it must be isolated from the electric mains supply, for example by removing the plug from the wall socket.



Permanent electrical installation must be carried out by an authorised electrician or competent person.

WARNING: THIS APPLIANCE MUST BE EARTHED.

The manufacturer declines any liability should this safety measure not be observed.

The appliance should not be connected to the electrical supply by means of an extension cable.

If the plug that is fitted to your appliance is not suitable for your socket outlet, it must be cut off and the appropriate plug fitted.

Remove the fuse from the cut off plug.

The cut off plug should then be disposed of to prevent the hazard of shocks in case it should be plugged into a 13 amp socket in another part of your home.

Important

The wires in the mains lead are coloured in accordance with the following code:

Green and Yellow	- Earth
Blue	- Neutral
Brown	- Live

If you fit your own plug, the colours of the wires in the mains lead of your appliance may not correspond with the markings identifying the terminals in your plug, proceed as follows:

Connect the Green and Yellow (earth) wire to the terminal in the plug which is marked with the letter «E» or the earth symbol \oplus or coloured green and yellow.

Connect the blue (neutral) wire to the terminal in the plug which is marked with the letter «N» or coloured black.

Connect the brown (live) wire to the terminal in the plug which is marked with the letter «L» or coloured red.

The plug moulded onto the lead incorporates a fuse.

For replacement, use a 13 amp BSI362 fuse.

Only ASTA or BSI approved fuses should be used.

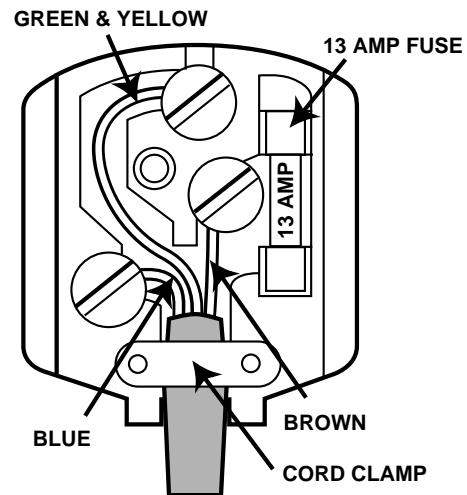

ZANUSSI

 **Electrolux**

© Electrolux plc 2004

 **From the Electrolux Group. The world's No.1 choice.**

The Electrolux Group is the world's largest producer of powered appliances for kitchen, cleaning and outdoor use. More than 55 million Electrolux Group products (such as refrigerators, cookers, washing machines, vacuum cleaners, chain saws and lawn mowers) are sold each year to a value of approx. USD 14 billion in more than 150 countries around the world.



AGB 03-06

Free Manuals Download Website

<http://myh66.com>

<http://usermanuals.us>

<http://www.somanuals.com>

<http://www.4manuals.cc>

<http://www.manual-lib.com>

<http://www.404manual.com>

<http://www.luxmanual.com>

<http://aubethermostatmanual.com>

Golf course search by state

<http://golfingnear.com>

Email search by domain

<http://emailbydomain.com>

Auto manuals search

<http://auto.somanuals.com>

TV manuals search

<http://tv.somanuals.com>