

ZANUSSI

Manual de
utilización

User's manual

Lavadora

Washing
Machine



ZWF 6115
ZWG 6105
ZWG 5125

ZANUSSI**Thank you for selecting our appliance**

We wish you lots of enjoyment with your new appliance and we hope that you will consider our brand again when purchasing household appliances.

Please read this user manual carefully and keep it throughout the product life cycle as a reference document. The user manual should be passed on to any future owner of the appliance.

The following symbols are used in this manual:



Important information concerning your personal safety and information on how to avoid damaging the appliance.



General information and tips



Environmental information

Content

Safety information -----	-32	Care and cleaning -----	-44
Description of the appliance -----	-34	Something not working -----	-46
Detergent dispenser drawer -----	-34	Technical data-----	-49
Control panel and functions -----	-35	Consumption values -----	-50
Programme table -----	-36	Installation instruction -----	-51
Washing Hints -----	-37	Environmental concerns -----	-55
Before the first use -----	-39	Guarantee conditions -----	-56
Operating Sequence -----	-40	Technical Service's Telephones -----	-57

Safety information

In the interest of your safety and to ensure the correct use, before installing and first using the appliance, read this user manual carefully, including its hints and warnings. To avoid unnecessary mistakes and accidents, it is important to ensure that all people using the appliance are thoroughly familiar with its operation and safety features. Save these instructions and make sure that they remain with the appliance if it is moved or sold, so that everyone using it through its life will be properly informed on appliance use and safety.

General safety

- It is dangerous to alter the specifications or attempt to modify this product in any way.
- During high temperature wash programmes the door glass may get hot. Do not touch it!
- Make sure that small pets do not climb into the drum. To avoid this, please check into the drum before using.
- Any objects such as coins, safety pins, nails, screws, stones or any other hard, sharp material can cause extensive damage and must not be placed into the machine.
- Only use the advised quantities of fabric softener and detergent. Damage to the fabric can ensue if you over-fill. Refer to the manufacturer's recommendations of quantities.
- Wash small items such as socks, laces, washable belts etc in a washing bag or pillow case as it is possible for such items to slip down between the tub and the inner drum.
- Do not use your washing machine to wash articles with whalebones, material without hems or torn material.

- Always unplug the appliance and turn off the water supply after use, clean and maintenance.
- Under no circumstances should you attempt to repair the machine yourself. Repairs carried out by inexperienced persons may cause injury or serious malfunctioning. Contact your local Service Centre. Always insist on genuine spare parts.

Installation

- This appliance is heavy. Care should be taken when moving it.
- When unpacking the appliance, check that it is not damaged. If in doubt, do not use it and contact the Service Centre.
- All packing and transit bolts must be removed before use. Serious damage can occur to the product and to property if this is not adhered to. See relevant section in the user manual.
- After having installed the appliance, check that it is not standing on the inlet and drain hose and the worktop is not pressing the electrical supply cable.
- If the machine is situated on a carpeted floor, please adjust the feet in order to allow air to circulate freely
- Always be sure, that there is no water leakage from hoses and their connections after the installation.
- If the appliance is installed in a location subject to frost, please read the «**dangers of freezing**» chapter.
- Any plumbing work required to install this appliance should be carried out by a qualified plumber or competent person.
- Any electrical work required to install this appliance should be carried out by a qualified electrician or competent person.

ZANUSSI

Use

- This appliance is designed for domestic use. It must not be used for purposes other than those for which it was designed.
- Only wash fabrics which are designed to be machine washed. Follow the instructions on each garment label.
- Do not overload the appliance. See the relevant section in the user manual.
- Before washing, ensure that all pockets are empty and buttons and zips are fastened. Avoid washing frayed or torn articles and treat stains such as paint, ink, rust, and grass before washing. Underwired bras must NOT be machine washed.
- Garments which have been in contact with volatile petroleum products should not be machine washed. If volatile cleaning fluids are used, care should be taken to ensure that the fluid is removed from the garment before placing in the machine.
- Never pull the power supply cable to remove the plug from the socket; always take hold of the plug itself.
- Never use the washing machine if the power supply cable, the control panel, the working surface or the base are damaged so that the inside of the washing machine is accessible.

Child safety

- This washing machine is not intended for use by young children or infirm persons without supervision.
- Young children should be supervised to ensure that they do not play with the appliance.
- The packaging components (e.g. plastic film, polystyrene) can be dangerous to children - danger of suffocation! Keep them out of children's reach
- Keep all detergents in a safe place out of children's reach.
- Make sure that children or pets do not climb into the drum. To avoid this the machine incorporates special feature.

Description of the appliance

- 1** Detergent dispenser drawer
- 2** Control panel
- 3** Door opening handle
- 4** Drain pump
- 5** Adjustable feet

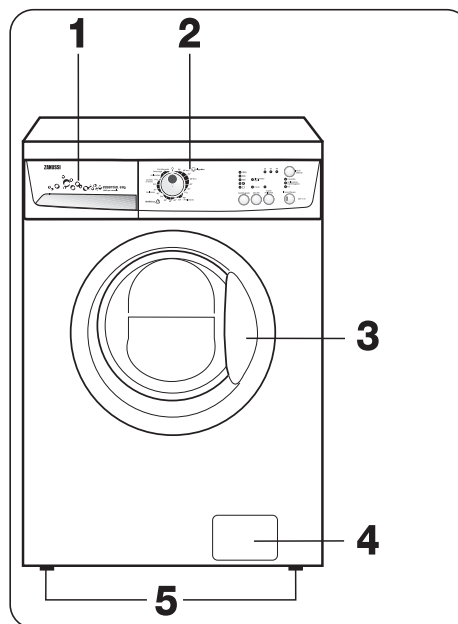

Detergent dispenser drawer

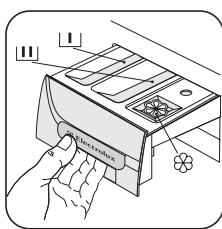

 Prewash

 Wash

 Fabric Softener



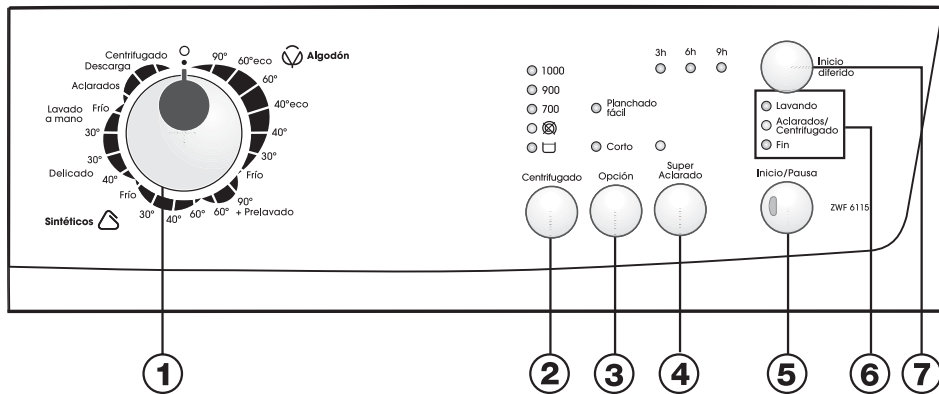

ZANUSSI

Control panel and functions



<p>1 Programme selector dial and On/Off switch</p>	<ul style="list-style-type: none"> • The programme selector dial allows to select a programme and/or to switch the machine on/off. It can be turned either clockwise or anticlockwise. The light Start/Pause starts to flash.
<p>2 Spin reduction button</p>	<ul style="list-style-type: none"> • Press the Spin button repeatedly to change the spin speed, if you want your laundry to be spun at a speed different from the one proposed by the washing machine or to select the Night cycle and Rinse Hold. The relevant light will light up.
<p>3 Options button</p>	<ul style="list-style-type: none"> • By means of the Options button, you can select only one of the following option: Prewash, Intensive, Super Quick (see the relevant chapter «Operating sequence»). • The relevant light will light up.
<p>4 Extra Rinse button</p>	<ul style="list-style-type: none"> • By means of this button, the machine performs some additional rinses.
<p>5 Start/Pause button</p>	<ul style="list-style-type: none"> • The Start/Pause button allows to start the selected programme; the corresponding green pilot light stops flashing. • This button interrupts also a programme which is running, the corresponding green pilot light starts to flash.
<p>6 Programme progress display</p>	<ul style="list-style-type: none"> • The different pilot lights illuminate depending on the running programme phase.
<p>7 Delay Start button</p>	<ul style="list-style-type: none"> • This button makes it possible to delay the starting of the washing programme by 3, 6 or 9 hours.

Programme table

Programme/ Temperature	Type of laundry	Options
 Cotton	White or colored For example: workcloths, bedcloths, tablecloths, etc	Rinse Hold Easy Iron Extra Rinse Super Quick (*)
 Synthetic	Synthetics or mixed fabrics , underwear, blouses, etc	Rinse Hold Prewash SuperQuick
 Delicates	Delicates fabrics to be gentle washed.	Rinse Hold
 Handwash	Special programme for hand washing fabrics (with the "hand washing " care symbol.	Rinse Hold
Rinse	Separate rinse cycle for hand washed items of cotton fabric.	
Drain	For emptying out the last rinse water in programmes with the Rinse Hold.	
Spin	Separate spin for cottons.	

(*) Not available with Eco and Prewash programmes.

(*) The "Cottons 60° Eco" is the reference programme for the data entered in the energy label, in compliance with EEC 92/75 standards."

ZANUSSI

Washing hints

Sorting the laundry

Follow the wash code symbols on each garment label and the manufacturer's washing instructions. Sort the laundry as follows: whites, coloureds, synthetics, delicates, woollens.

Temperatures

90°	for normally soiled white cottons and linen (e.g. tea cloths, towels, tablecloths, sheets...)
50°/60°	for normally soiled, colour fast garments (e.g. shirts, night dresses, pyjamas...) in linen, cotton or synthetic fibres and for lightly soiled white cotton (e.g. underwear).
30°-40°-Cold	for delicate items (e.g. net curtains), mixed laundry including synthetic fibres and woollens bearing the label «pure new wool, machine washable, non-shrink».

Before loading the laundry

Never wash whites and coloureds together. Whites may lose their «whiteness» in the wash.

New coloured items may run in the first wash; they should therefore be washed separately the first time.

Make sure that no metal objects are left in the laundry (e.g. hair clips, safety pins, pins). Button up pillowcases, close zip fasteners, hooks and poppers. Tie any belts or long tapes.

Remove persistent stains before washing. Rub particularly soiled areas with a special detergent or detergent paste.

Treat curtains with special care. Remove hooks or tie them up in a bag or net.

Maximum loads

Recommended loads are indicated in the programme charts.

General rules:

Cotton, linen: drum full but not too tightly packed;

Synthetics: drum no more than half full;

Delicate fabrics and woollens: drum no more than one third full.

Washing a maximum load makes the most efficient use of water and energy.

For heavily soiled laundry, reduce the load size.

Laundry weights

The following weights are indicative:

bathrobe	1200 g
napkin	100 g
quilt cover	700 g
sheet	500 g
pillow case	200 g
tablecloth	250 g
towelling towel	200 g
tea cloth	100 g
night dress	200 g
ladies' briefs	100 g
man's work shirt	600 g
man's shirt	200 g
man's pyjamas	500 g
blouse	100 g
men's underpants	100 g

Removing stains

Stubborn stains may not be removed by just water and detergent. It is therefore advisable to treat them prior to washing.

Blood: treat fresh stains with cold water. For dried stains, soak overnight in water with a special detergent then rub in the soap and water.

Oil based paint: moisten with benzine stain remover, lay the garment on a soft cloth and dab the stain; treat several times.

Dried grease stains: moisten with turpentine, lay the garment on a soft surface and dab the stain with the fingertips and a cotton cloth.

Rust: oxalic acid dissolved in hot water or a rust removing product used cold. Be careful with rust stains which are not recent since the cellulose structure will already have been damaged and the fabric tends to hole.

Mould stains: treat with bleach, rinse well (whites and fast coloureds only).

Grass: soap lightly and treat with bleach (whites and fast coloureds only).

Ball point pen and glue: moisten with acetone (*), lay the garment on a soft cloth and dab the stain.

Lipstick: moisten with acetone as above, then treat stains with methylated spirits. Remove any residual marks from white fabrics with bleach.

Red wine: soak in water and detergent, rinse and treat with acetic or citric acid, then rinse. Treat any residual marks with bleach.

Ink: depending on the type of ink, moisten the fabric first with acetone (*), then with acetic acid; treat any residual marks on white fabrics with bleach and then rinse thoroughly.

Tar stains: first treat with stain remover, methylated spirits or benzine, then rub with detergent paste.

(*) do not use acetone on artificial silk.

Detergents and additives

Good washing results also depend on the choice of detergent and use of the correct quantities to avoid waste and protect the environment. Although biodegradable, detergents contain substances which, in large quantities, can upset the delicate balance of nature.

The choice of detergent will depend on the type of fabric (delicates, woollens, cottons,

etc.), the colour, washing temperature and degree of soiling.

All commonly available washing machine detergents may be used in this appliance:

- powder detergents for all types of fabric,
- powder detergents for delicate fabrics (60°C max) and woollens,
- liquid detergents, preferably for low temperature wash programmes (60°C max) for all types of fabric, or special for woollens only.

The detergent and any additives must be placed in the appropriate compartments of the dispenser drawer before starting the wash programme.

If using concentrated powder or liquid detergents, a programme **without** prewash must be selected.

Pour liquid detergent into the dispenser drawer compartment marked **III** **just before** starting the programme.

Any fabric softener or starching additives must be poured into the compartment marked **IV** before starting the wash programme.

Follow the product manufacturer's recommendations on quantities to use and **do not exceed the «MAX» mark in the detergent dispenser drawer.**

ZANUSSI

Quantity of detergent to be used

The type and quantity of detergent will depend on the type of fabric, load size, degree of soiling and hardness of the water used. Water hardness is classified in so-called «degrees» of hardness. Information on hardness of the water in your area can be obtained from the relevant water supply company, or from your local authority. Follow the product manufacturers' instructions on quantities to use.

Use less detergent if:

- you are washing a small load,
- the laundry is lightly soiled,
- large amounts of foam form during washing.

Degrees of water hardness

Level	Characteristic	Degrees	
		German °dH	French °T.H.
1	soft	0-7	0-15
2	medium	8-14	16-25
3	hard	15-21	26-37
4	very hard	> 21	> 37

Before the first use

WARNING!

Ensure that the electrical and water connections comply with the installation instructions.

IMPORTANT!

Remove the polystyrene block and any material from the drum.

IMPORTANT!

Pour 2 litres of water into the main wash compartment  of the detergent drawer in order to activate the ECO valve. Then run a cotton cycle at 95°C, without any laundry in the machine, to remove any manufacturing residue from the drum and tub. Pour 1/2 a measure of detergent into the dispenser drawer and start the machine.

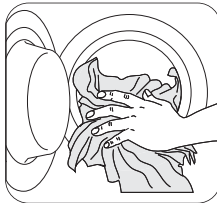

Operating sequence

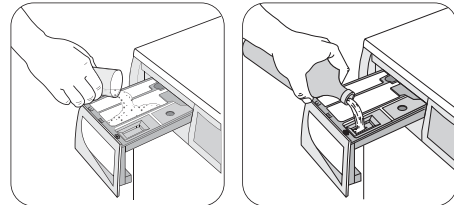

1. Load the laundry
Open the door by carefully pulling the door handle outwards. Place the laundry in the drum, one item at a time, shaking them out as much as possible. Close the door.

2. Measure out the detergent and the fabric softener



Pull out the dispenser drawer until it stops. Measure out the amount of detergent required, pour it into the main wash compartment  and, if you wish to carry out a programme with the prewash phase, pour it into the compartment marked .

If required, pour fabric softener into the compartment marked  (the amount used must not exceed the «MAX» mark in the drawer). Close the drawer gently.

3. Select the required programme

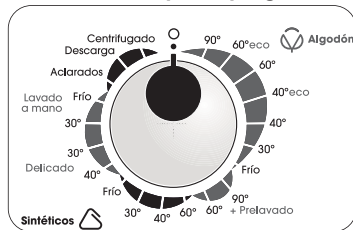

The selector dial is divided into following sections:

- **Cottons,**
- **Synthetics**

The green Start/Pause light starts to flash. The selector dial can be turned either clockwise or anticlockwise.

Position «Off» to Reset programme/Switching OFF of the machine.

At the end of the programme the selector dial must be turned to position «Off», to switch the machine off.

IMPORTANT!

If you turn the programme selector dial to another programme when the machine is working, the red Start/Pause pilot light will flash 3 times to indicate a wrong selection. The machine will not perform the new selected programme.

4. Select the spin speed or Night Cycle or Rinse Hold option

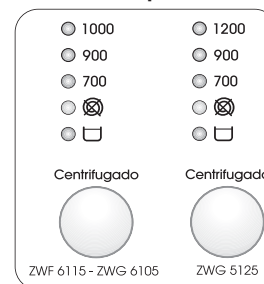



Press the Spin button repeatedly to change the spin speed, if you want your laundry to be spun at a speed different from the one proposed by the appliance.

The relevant light will light up.

Maximum speeds are:

- Cottons: 1000, 1200 rpm depending on the Model;
- Synthetics, Handwash: 900 rpm
- Delicates: 700 rpm;

No Spin : By selecting this option, all spinning phases are suppressed. On Cotton, Synthetics and Delicates programmes, the rinses will be performed with more water.

Rinse Hold : by selecting this option the water of the last rinse is not emptied out to prevent the fabrics from creasing. When the programme has finished the pilot lights «Door» and «End» are alight, the Start/Pause and «Wash» lights are off and the door is locked to indicate that the water must be emptied out.

ZANUSSI

Operating sequence

To empty out the water:

1. turn the programme selector dial to «Off»
2. select the **Drain** or **Spin** programme
3. reduce the spin speed if needed, by means of the relevant button
4. depress Start/Pause button
5. at the end of programme, only the pilot lights End comes on.

5. Select Easy Iron or Super Quick option

Press the «Options» button repeatedly, to select only one of the available options. The relevant light will light up.

Easy Iron: by selecting this option, the

Planchado
f cil

Corto

Opci n



washing and rinse is performed softly. This option avoid to crease laundry.

This option isn't available for Handwash, Delicates, Prewash and Eco programmes.

Super Quick: a very short cycle for slightly soiled items that have been used or worn for a short time.

This option is **not available** with the Handwash, and Eco programmes.

The **max. load** recommended for cotton: is 3 kg and for synthetic and delicate is 1.5 kg.

IMPORTANT!

If an option is chosen that is not allowed with the selected programme, the **red** pilot light of the Start/Pause button will flash 3 times.

The washing time will be reduced according to the type of fabric and the selected temperature.

6. Select the Extra Rinse option



This button can be selected with all programmes except the Hand wash program. The machine performs some additional rinses. This option is recommended for people who are allergic to detergents, and in areas where the water is very soft.

7. Select the Start/Pause

- Lavando
- Aclarados/
Centrifugado
- Fin

Inicio/Pausa



To start the selected programme, press the Start/Pause button; the corresponding green pilot light stops flashing.

The «Wash» and «Door» lights are alight to indicate that the appliance starts operating and the door is locked.

To **interrupt** a programme which is running, depress the Start/Pause button: the corresponding green pilot light starts to flash.

To **restart** the programme from the point at which it was interrupted, press the Start/Pause button again.

If you have chosen a delayed start, the machine will begin the countdown.

IMPORTANT!

If an incorrect option is selected, the red pilot light of the Start/ Pause button flashes for 3 times.

Operating sequence

8. Select the Delay Start



Before you start the programme, if you wish to delay the start, press the Delay Start button repeatedly, to select the desired delay.

The relevant light illuminates.

This button makes it possible to delay the starting of the washing programme by 3, 6, and 9 hours.

You must select this option after you have set the programme and before you press the Start/Pause button.

You can cancel the delay time at any moment, before you press the Start/Pause button.

If you have already pressed the Start/Pause button, and you wish to cancel the delay time, proceed as follows:

- set the washing machine to PAUSE by pressing the Start/Pause button;
- press the Delay Start button once, the light relevant to the selected delay goes off.
- press the Start/Pause button again to start the programme.

IMPORTANT!

- The selected delay can be changed only after selecting the washing programme again.
- The door will be locked throughout the delay time. If you need to open the door, you must first set the washing machine to PAUSE by pressing the Start/Pause button and then wait about 2 minutes until the «Door» light has gone off. After you have closed the door, press the Start/Pause button again.

The Delay Start can not be selected with Drain programmes.

Programme progress display

After having depress Start/Pause button, the «Wash» pilot light illuminates and stays on while the machine is working.

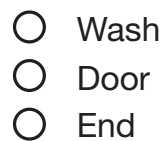

The «Door» pilot light indicates if the door can be opened:

- light on: the door cannot be opened. The appliance is running.
- light off: the door can be opened. The washing programme is finished.
- flashing light: the door is opening.

When the programme has finished, the «End» pilot light illuminates and the «Wash» light goes off.

Altering an option or a running programme

It is possible to change any option before the programme carries it out. Before you make any change, you must pause the washing machine by pressing the Start/Pause button. Changing a running programme is possible only by resetting it. Turn the programme selector dial to Off and then to the new programme position. The washing water in the tub will not emptied out. Start the new programme by depressing the Start/Pause button again.

Interrupting a programme

Depress the Start/Pause button to interrupt a programme which is running, the corresponding light starts to flash. Depress the button again to restart the programme.

ZANUSSI

Cancelling a programme

Turn the selector dial to Off to cancel a programme which is running. Now you can select a new programme.

Opening the door after the programme has started

First set the machine to pause by pressing the Start/Pause button.

If the «Door» light flashes and after 2 minutes goes off, the door can be opened.

If the «Door» light does not flash, this means that the machine is already heating, that the water level is above the bottom edge of the door or that the drum is turning.

In this case the door can not be opened.

If you cannot open the door but you need to open it you have to switch the machine off by turning the selector dial to «Off».

After about 2 minutes the door can be opened (pay attention to the water level and temperature!).

At the end of the programme

The machine stops automatically. The Start/Pause and «wash» lights go off and the «end» phase light illuminates. The door can be opened (the Door light is off).

If the «Rinse Hold» or «No spin» option has been selected, the «end» and «door» lights illuminates but the door remains locked to indicate that the water must be emptied out before opening the door.

To empty out the water please read the steps on the Rinse Hold option paragraph.

Turn the programme selector dial to «Off» to switch the machine off. Remove the laundry from the drum and carefully check that the drum is empty.

If you do not intend to carry out another wash, close the water tap. Leave the door open to prevent the formation of mildew and unpleasant smells.

Care and cleaning

IMPORTANT!

You must **DISCONNECT** the appliance from the electricity supply, before you can carry out any cleaning or maintenance work.

Descaling

The water we use normally contains lime. It is a good idea to periodically use a water softening powder in the machine. Do this separately from any laundry washing, and according to the softening powder manufacturer's instructions. This will help to prevent the formation of lime deposits.

Maintenance Wash

With the use of low temperature washes it is possible to get a build up of residues inside the drum.

We recommend that a maintenance wash be performed on a regular basis.

To run a maintenance wash:

- The drum should be empty of laundry.
- Select the hottest cotton wash programme.
- Use a normal measure of detergent, must be a powder with biological properties.

External cleaning

Clean the exterior cabinet of the appliance with soap and water only, and then dry thoroughly.

Cleaning the dispenser drawer

The washing powder and additive dispenser drawer should be cleaned regularly.

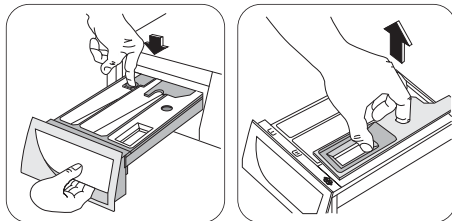

To aid cleaning, the top part of the additive compartment should be removed. Remove the drawer by pressing the catch downwards and by pulling it out. Flush it out under a tap, to remove any traces of accumulated powder.

Cleaning the drawer recess

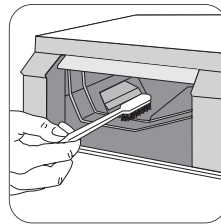

Having removed the drawer, use a small brush to clean the recess, ensuring that all washing powder residue is removed from the upper and lower part of the recess.

Replace the drawer and run the rinse programme without any clothes in the drum.

Cleaning the pump

The pump should be inspected if

- the machine does not empty and/or spin
- the machine makes an unusual noise during draining due to objects such as safety pins, coins etc. blocking the pump.

Proceed as follows:

- Pull out the plug from the power socket.
- If necessary, wait until the water has cooled down.
- Open the drainage area door.
- Place a bowl to collect the water.
- Turn slowly the lid of the diaphragm towards left side and allow that the water of the washing machine goes flowing slowly to the bowl.
- When the bowl is full, turn and close the lid of the diaphragm.
- Empty the bowl. Repeat the procedure until you have completely emptied the washing machine.
- To continue, unscrew the lid of the diaphragm by turning it counter clockwise and pull it out.
- Always keep a rag nearby to dry up spillage of water when removing the cover.
- Remove the objects such as buttons, coins and the lint that has been accumulated in the area of the pump impeller by rotating it.

ZANUSSI

- Screw the lid of the diaphragm clockwise, be sure is completely tighten.
- Close the drainage area door.

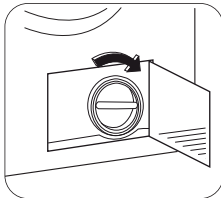
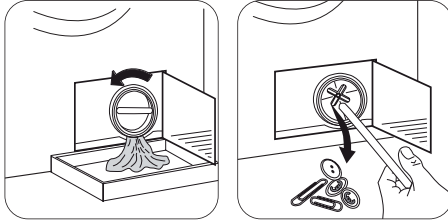

IMPORTANT!

When the appliance is in use and depending on the programme selected there can be hot water in the pump.

Never remove the pump cover during a wash cycle, always wait until the appliance has finished the cycle, and is empty. When replacing the cover, ensure it is securely retightened so as to stop leaks and young children being able to remove it.

Cleaning the water inlet filter

If your water is very hard or contains traces of lime deposit, the water inlet filter may become clogged.

It is therefore a good idea to clean it from time to time.

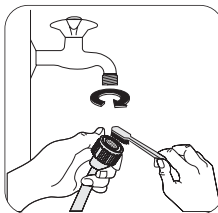

Turn off the water tap. Unscrew the water inlet hose. Clean the filter using a hard bristle brush. Tighten up the inlet hose.

The dangers of freezing

If the machine is exposed to temperatures below 0°C, certain precautions should be taken.

- Turn off the water tap.
- Unscrew the inlet hose.
- Place the end of the inlet hose in a bowl placed on the floor and let water drain out.
- Screw the water inlet hose back on
- When you intend to start the machine up again, make sure that the room temperature is above 0°C.

IMPORTANT!

Every time you drain the water through the emergency emptying hose you must pour 2 litres of water into the main wash compartment of the detergent drawer and then run the drain programme. This will activate the **ECO VALVE** device avoiding that part of the detergent remains unused at next washing.

Emergency emptying out

If the water is not discharged, proceed as follows to empty out the machine:

- pull out the plug from the power socket;
- close the water tap;
- if necessary, wait until the water has cooled down;
- open the pump door;
- clean the pump if necessary as previously described;
- screw the pump cover again and close the door.

Something not working

IMPORTANT!



Certain problems are due to lack of simple maintenance or oversights, which can be solved easily without calling out an engineer. Before contacting your local Service Centre, please carry out the checks listed below.

During machine operation it is possible that the **red Start/Pause pilot light** flashes to indicate that the machine is not working.

Once the problem has been eliminated, press the Start/Pause button to restart the programme. If after all checks, the problem persists, contact your local Service Centre.

Malfunction	Possible Cause / Solution
The washing machine does not start:	<p>The door has not been closed. (Red Start/Pause pilot light flashes)</p> <ul style="list-style-type: none"> • Close firmly the door. <p>The plug is not properly inserted in the power socket.</p> <ul style="list-style-type: none"> • Insert the plug into the power socket. <p>There is no power at the socket.</p> <ul style="list-style-type: none"> • Please check your domestic electrical installation. <p>The main fuse has blown.</p> <ul style="list-style-type: none"> • Replace the fuse. <p>The selector dial is not correctly positioned and the Start/Pause button has not been depressed.</p> <ul style="list-style-type: none"> • Please turn the selector dial and press the Start/Pause button again. <p>The delay start has been selected.</p> <ul style="list-style-type: none"> • If the laundry are to be washed immediately, cancel the delay start
The machine does not fill:	<p>The water tap is closed. (Red Start/Pause pilot light flashes)</p> <ul style="list-style-type: none"> • Open the water tap. <p>The inlet hose is squashed or kinked. (Red Start/Pause pilot light flashes)</p> <ul style="list-style-type: none"> • Check the inlet hose connection. <p>The filter in the inlet hose is blocked. (Red Start/Pause pilot light flashes)</p> <ul style="list-style-type: none"> • Clean the water inlet hose filter. <p>The door is not properly closed. (Red Start/Pause pilot light flashes)</p> <ul style="list-style-type: none"> • Close firmly the door.

ZANUSSI

Malfunction	Possible Cause / Solution
The machine fills then empties immediately:	<p>The end of the drain hose is too low.</p> <ul style="list-style-type: none"> Refer to relevant paragraph in «water drainage» section.
The machine does not empty and/or does not spin:	<p>The drain hose is squashed or kinked. (Red Start/ Pause pilot light flashes)</p> <ul style="list-style-type: none"> Check the drain hose connection. <p>The drain pump is clogged. (Red Start/Pause pilot light flashes)</p> <ul style="list-style-type: none"> Clean the drain pump. <p>The option  or  has been selected.</p> <ul style="list-style-type: none"> Select the Drain or Spin programmes <p>The laundry is not evenly distributed in the drum.</p> <ul style="list-style-type: none"> Redistribute the laundry.
There is water on the floor:	<p>Too much detergent or unsuitable detergent (creates too much foam) has been used.</p> <ul style="list-style-type: none"> Reduce the detergent quantity or use another one. <p>Check whether there are any leaks from one of the inlet hose fittings. It is not always easy to see this as the water runs down the hose; check to see if it is damp.</p> <ul style="list-style-type: none"> Check the water inlet hose connection. <p>The inlet hose is damaged.</p> <ul style="list-style-type: none"> Change it with a new one..
Unsatisfactory washing results:	<p>Too little detergent or unsuitable detergent has been used.</p> <ul style="list-style-type: none"> Increase the detergent quantity or use another one. <p>Stubborn stains have not been treated prior to washing.</p> <ul style="list-style-type: none"> Use commercial products to treat the stubborn stains. <p>The correct temperature was not selected.</p> <ul style="list-style-type: none"> Check if you have selected the correct temperature. <p>Excessive laundry load.</p> <ul style="list-style-type: none"> Introduce into the drum less laundry.



Malfunction	Possible Cause / Solution
The door will not open:	<p>The programme is still running.</p> <ul style="list-style-type: none"> • Wait the end of washing cycle. <p>The door lock has not been released.</p> <ul style="list-style-type: none"> • Wait about 2 minute. <p>There is water in the drum.</p> <ul style="list-style-type: none"> • Select drain or spin programme to empty out the water.
The machine vibrates or is noisy:	<p>The transit bolts and packing have not been removed.</p> <ul style="list-style-type: none"> • Check the correct installation of the appliance. <p>The support feet have not been adjusted.</p> <ul style="list-style-type: none"> • Check the correct levelling of the appliance. <p>The laundry is not evenly distributed in the drum.</p> <ul style="list-style-type: none"> • Redistribute the laundry. <p>Maybe there is very little laundry in the drum.</p> <ul style="list-style-type: none"> • Load more laundry.
Spinning starts late or the machine does not spin:	<p>The electronic unbalance detection device has cut in because the laundry is not evenly distributed in the drum. The laundry is redistributed by reverse rotation of the drum. This may happen several times before the unbalance disappears and normal spinning can resume. If, after 10 minutes, the laundry is still not evenly distributed in the drum, the machine will not spin. In this case, redistribute the load manually and select the spin programme.</p> <ul style="list-style-type: none"> • Redistribute the laundry.
The machine makes an unusual noise	<p>The machine is fitted with a type of motor which makes an unusual noise compared with other traditional motors. This new motor ensures a softer start and more even distribution of the laundry in the drum when spinning, as well as increased stability of the machine.</p>
No water is visible in the drum	<p>Machines based on modern technology operate very economically using very little water without affecting performance.</p>

If you are unable to identify or solve the problem, contact our service centre. Before telephoning, make a note of the model, serial number and purchase date of your machine: the Service Centre will require this information.

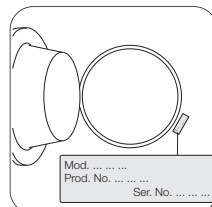

ZANUSSI**Technical data**

Dimensions	Width	60 cm
	Height	85 cm
	Depth (including the porthole)	63 cm
Electrical connection Voltage - Overall power - Fuse	Information on the electrical connection is given on the rating plate on the inner edge of the appliance door	
Water supply pressure	Minimum	0,05 MPa
	Maximum	0,8 MPa
Maximum Load	ZWF 6115	5kg
	ZWG 6105	6kg
	ZWG 5125	6kg
Spin Speed	Maximum	ZWF 6115 1000 rpm
		ZWG 6105 1000 rpm
		ZWG 5125 1200 rpm

Consumption values

Programme	Programme duration (in minutes)	Energy consumption (in kWh)	Water consumption (in litres)
Cottons 95°C	125	2.0	61
Cottons 60° Eco(*)	ZWG6105-ZWG 5125....155 ZWF6115125	ZWG6105-ZWG 5125...1.02 ZWF61150.85	ZWG6105-ZWG 5125.....54 ZWF611552
Cottons 60°C - 40°C	100	1.3	58
Cottons 40°C Eco	145	1.14	54
Synthetics 60° C - Cold	80	0.8	51
Delicates 40° - Cold	55	0.55	60
Handwash 30° - Cold	60	0.4	53
Rinse	45	0.1	42
Drain	2	-	-
Spin	10	-	-

Infos

The consumption data shown on this chart is to be considered purely indicative, as it may vary depending on the quantity and type of laundry, on the inlet water temperature and on the ambient temperature. It refers to the highest temperature for each wash programme.

(*) The "Cottons 60° Eco" is the reference programme for the data entered in the energy label, in compliance with EEC 92/75 standards.

ZANUSSI

Installation instruction

Transit security bars

Before starting the machine up, the transport security bars must be removed as follows: You are advised to keep all the transport security bars. In case the appliance has to be transported again.

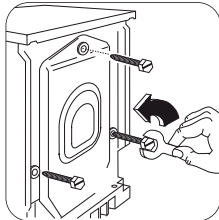

1. Unscrew and remove the three rear screws by means of a key.

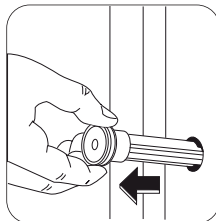
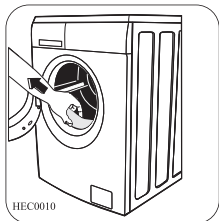

2. Open the porthole and remove the polystyrene block fitted with adhesive tape on the door seal.
3. Place the machine in an upright position and remove the three plastic bolts.

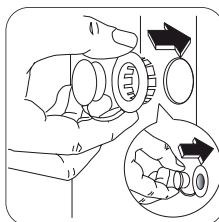

4. Plug the 3 holes with the plastic plugs which you can find in the envelope containing the instruction booklet.

Positioning

Install the machine on a flat hard floor. Make sure that air circulation around the machine is not impeded by carpets, rugs etc. Check that the machine does not touch the wall or other kitchen units. Level the washing machine by raising or lowering the feet. Once in the right position fix the feet by pushing the nuts against the base of the case. The feet may be tight to adjust as they incorporate but the machine **MUST** be level and stable. If necessary, check the setting with a spirit level.

Accurate levelling prevents vibration, noise and displacement of the machine during operation. Never place cardboard, wood or similar materials under the machine to compensate for any unevenness in the floor. Some vibration is inevitable, especially if mounted on a wooden floor.

Sprung wooden floors are particularly susceptible to vibration. For advice, consult a builder. If possible, always place the machine on a solid floor.

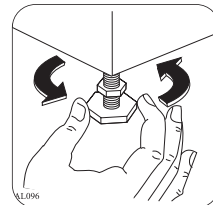
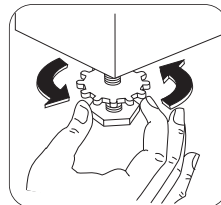

Water inlet

There should be a COLD WATER tap near the washing machine with a screwing on connection pipe of 3/4" for the water supply, a sink, a wash basin or a drainage system in the wall.

Previously check if:

- it is not a hot water tap.
- the running water is clean. If not, run off a reasonable amount of water to flush out any debris that may have collected in the pipes. Have the permanent drainage system in the wall checked by a plumber.

1. Connect the hose to a tap with a 3/4" thread. Always use the hose supplied with the appliance. The inlet hose must not be lengthened. If it is too short and you do not wish to move the tap, you will have to purchase a new, longer hose specially designed for this type of use.



NOTE

Installation should comply with local water authority and building regulations' requirements.

2. If necessary turn the hose adequately by unscrewing the nut at the rear of the appliance. Now tighten the nut anew to avoid leaks. (Open the tap and assure that it does not leak and close it again.)

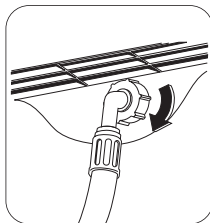

The appliance must be connected to a cold water supply.

A minimum water pressure of 0.05 MPa (0.5 bar) is required for safe operation of the appliance.

If you cannot make the cold water connection direct from the rising mains, you may be able to operate the appliance from your cold water storage system.

There should be a minimum distance of 5.02m (16.5 ft) between the appliance's inlet and the bottom of the water storage tank.

Water drainage

This appliance is designed to be permanently plumbed into your home's drainage system using one of the following methods.

1. Into a drainage standpipe.

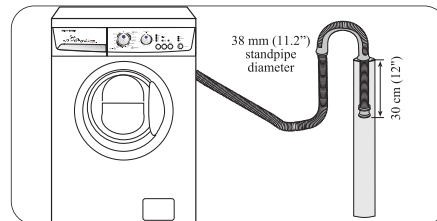
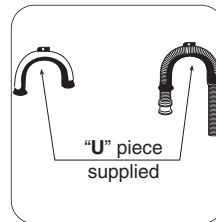

Firstly form a hook in the end of the drain hose using the «U» piece supplied. Place the drain hose into your standpipe, which should have an internal diameter of approximately 38mm thus ensuring there is an air break between the drain hose and standpipe.

When discharging into a standpipe ensure that the top of the standpipe is no more than 90 cm (35.4") and no less than 60 cm (23.6") above floor level.

ZANUSSI

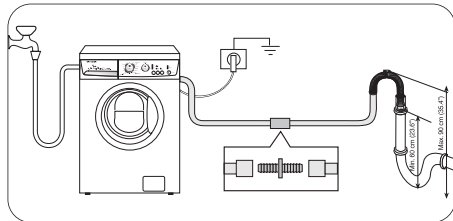

The drain hose may be extended to a maximum of 4 metres. An additional drain hose and joining piece is available from your local Service Force Centre. The joining piece must have an internal diameter of 18mm.

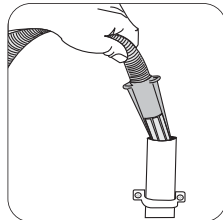

If your drain hose looks like this (see below) you do not require the «U» piece. Just push the hose firmly into the standpipe.

2. Onto a sink outlet spigot.

If the outlet spigot has not been used before, remove any blanking plug that may be in place.

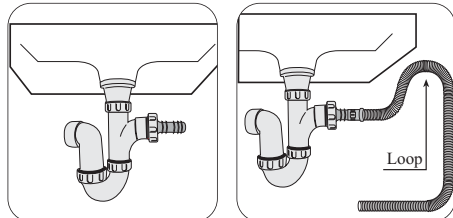

Push the drain hose onto the spigot and secure with a clip if required, ensure a loop is formed in the drain hose (see diagram) to prevent waste from the sink entering the washing machine.

Important!

Before connecting the machine to new pipework or to pipework that has not been used for some time, run off a reasonable amount of water to flush out any debris that may have collected in the pipes.

Special conditions

If the floor is carpeted or covered with crumbly or soft material, insert a rigid support base under the feet to prevent noise, vibration or displacement. The base should protrude a few centimetres beyond the edges of the machine.

! WARNING!

The machine should NOT be placed on deep pile carpeting.

NOTE

Please ensure that when the appliance is installed it is easily accessible for the engineer in the event of a breakdown.

In the interest of the environment

Washing machines and dishwashers should be connected to the FOUL drainage system, the water will then be taken to a sewage works for treatment before being discharged safely into a river. It is essential that these appliances are not connected to the surface water drainage system as this water is discharged directly into a river or stream and may cause pollution.

If you require any further advice please contact your local water authority.

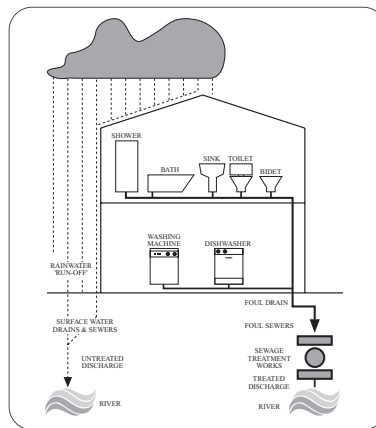



Electrical connection

Any electrical work required to install this appliance should be carried out by a qualified electrician or competent person.

! WARNING!

This appliance must be earthed.

The manufacturer declines any liability should this safety measure not be observed.

Before switching on, make sure the electricity supply voltage is the same as that indicated on the appliance's rating plate.

IMPORTANT!

Information on the electrical connection is given on the rating plate on the inner edge of the appliance door.

The appliance is supplied with a 13amp plug fitted. In the event of having to change the fuse in the plug supplied, a 13amp ASTA approved (BS1363/A) fuse must be used.

Should the plug need to be replaced for any reason, proceed as described below.

The wires in the mains lead are coloured in accordance with the following code:

- Green and Yellow- Earth
- Blue- Neutral
- Brown.....- Live

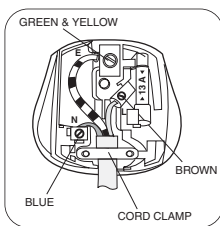

The wire coloured green and yellow must be connected to the terminal marked with the letter «E» or by the earth symbol  or coloured green and yellow.

The wire coloured blue must be connected to the terminal marked «N» or coloured black.

The wire coloured brown must be connected to the terminal marked «L» or coloured red. Upon completion there must be no cut, or stray strands of wire present and the cord clamp must be secure over the outer sheath.

! WARNING!

A cut off plug inserted into a 13 amp socket is a serious safety (shock) hazard. Ensure that the cut off plug is disposed of safely. Should the appliance power supply cable need to be replaced, this must be carried out by our Service Force Centre.

The power supply cable must be easily accessible after installing the appliance.

Permanent connection

In the case of permanent connection it is necessary that you install a double pole switch between the appliance and the electricity supply (mains), with a minimum gap of 3mm between the switch contacts and of a type suitable for the required load in compliance with the current electrical regulations.

The switch must not break the yellow and green earth cable at any point.

ZANUSSI

Environmental concerns

Packaging materials

The materials marked with the symbol  are recyclable.

>PE<=polyethylene

>PS<=polystyrene

>PP<=polypropylene

This means that they can be recycled by disposing of them properly in appropriate collection containers.

Old machine

Use authorised disposal sites for your old appliance. Help to keep your country tidy!

The symbol  on the product or on its packaging indicates that this product may not be treated as household waste. Instead it shall be handed over to the applicable collection point for the recycling of electrical and electronic equipment. By ensuring this product is disposed of correctly, you will help prevent potential negative consequences for the environment and human health, which could otherwise be caused by inappropriate waste handling of this product. For more detailed information about recycling of this product, please contact your local city office, your household waste disposal service or the shop where you purchased the product.

Ecological hints

To save water, energy and to help protect the environment, we recommend that you follow these tips:

- Normally soiled laundry may be washed without prewashing in order to save detergent, water and time (the environment is protected too!).
- The machine works more economically if it is fully loaded.
- With adequate pre-treatment, stains and limited soiling can be removed; the laundry can then be washed at a lower temperature.
- Measure out detergent according to the water hardness, the degree of soiling and the quantity of laundry being washed.

Guarantee conditions

Standard guarantee conditions

We, Electrolux, undertake that if within 12 months of the date of the purchase this Electrolux appliance or any part thereof is proved to be defective by reason only of faulty workmanship or materials, we will, at our option repair or replace the same FREE OF CHARGE for labour, materials or carriage on condition that:

- The appliance has been correctly installed and used only on the electricity supply stated on the rating plate.
- The appliance has been used for normal domestic purposes only, and in accordance with the manufacturer's instructions.
- The appliance has not been serviced, maintained, repaired, taken apart or tampered with by any person not authorised by us.
- Electrolux Service Force Centre must undertake all service work under this guarantee
- Any appliance or defective part replaced shall become the Company's property.
- This guarantee is in addition to your statutory and other legal rights.

Exclusions

- Damage or calls resulting from transportation, improper use or neglect, the replacement of any light bulbs or removable parts of glass or plastic.
- Costs incurred for calls to put right an appliance which is improperly installed or calls to appliances outside the United Kingdom.
- Appliances found to be in use within a commercial environment, plus those which are subject to rental agreements.
- Products of Electrolux manufacturer that are not marketed by Electrolux.

European Guarantee

This appliance is guaranteed by Electrolux in each of the countries listed at the back of this user manual, for the period specified in the appliance



guarantee or otherwise by law. If you move from one of these countries to another of the countries listed below the appliance guarantee will move

with you subject to the following qualifications:

- The appliance guarantee starts from the date you first purchased the appliance which will be evidenced by production of a valid purchase document issued by the seller of the appliance.
- The appliance guarantee is for the same period and to the same extent for labour and parts as exists in your new country of residence for this particular model or range of appliances.
- The appliance guarantee is personal to the original purchaser of the appliance and cannot be transferred to another user.
- The appliance is installed and used in accordance with instructions issued by Electrolux and is only used within the home, i.e. is not used for commercial purposes.
- The appliance is installed in accordance with all relevant regulations in force within your new country of residence.

The provisions of this European Guarantee do not affect any of the rights granted to you by law."

ZANUSSI**www.electrolux.com**

		
Belgique/België/Belgien	+32 2 363 04 44	Bergensesteenweg 719, 1502 Lembeek
Česká republika	+420 2 61 12 61 12	Budějovická 3, Praha 4, 140 21
Danmark	+45 70 11 74 00	Sjællandsgade 2, 7000 Fredericia
Deutschland	+49 180 32 26 622	Muggenhofer Str. 135, 90429 Nürnberg
Eesti	+37 2 66 50 030	Mustamäe tee 24, 10621 Tallinn
España	+34 902 11 63 88	Carretera M-300, Km. 29,900 Alcalá de Henares Madrid
France	www.electrolux.fr	
Great Britain	+44 8705 929 929	101 Oakley Road LUTON Beds LU4 9RJ
Hellas	+30 23 10 56 19 70	4, Limnou Str., 54627 Thessaloniki
Hrvatska	+38 51 63 23 338	Slavonska avenija 3, 10000 Zagreb
Ireland	+353 1 40 90 753	Longmile Road Dublin 12
Italia	+39 (0) 434 558500	C.so Lino Zanussi, 26 - 33080 Porcia (PN)
Latvija	+37 17 84 59 34	Kr. Barona iela 130/2, LV-1012, Riga
Lituania	+370 5 27 80 609	Verkiu 29, 09108 Vilnius, Lithuania
Luxembourg	+35 2 42 43 13 01	Rue de Bitbourg, 7, L-1273 Hamm
Magyarország	+36 1 252 1773	H-1142 Budapest XIV, Erzsébet királyné útja 87
Nederland	+31 17 24 68 300	Vennootsweg 1, 2404 CG - Alphen aan den Rijn
Norge	+47 81 5 30 222	Risløkkvn. 2, 0508 Oslo
Österreich	+43 18 66 400	Herziggasse 9, 1230 Wien
Polska	+48 22 43 47 300	ul. Kolejowa 5/7, Warsaw
Portugal	+35 12 14 40 39 39	Quinta da Fonte - Edifício Gonçalves Zarco - Q35 -2774-518 Paço de Arcos
Romania	+40 21 44 42 581	B-dul Timisoara 90, S6, Bucharest
Schweiz - Suisse - Svizzera	+41 62 88 99 111	Industriestrasse 10, CH-5506 Mägenwil
Slovenija	+38 61 24 25 731	Tržaška 132, 1000 Ljubljana
Slovensko	+421 2 43 33 43 22	Electrolux Slovakia s.r.o., Electrolux Domáce spotrebiče SK, Seberínho 1, 821 03 Bratislava
Suomi	+35 8 26 22 33 00	Konepajaranta 4, 28100 Pori
Sverige	+46 (0)771 76 76 76	Electrolux Service, S:t Göransgatan 143, S-105 45 Stockholm
Türkiye	+90 21 22 93 10 25	Tarlabası caddesi no : 35 Taksim Istanbul
Россия	+7 095 937 7837	129090 Москва, Олимпийский проспект, 16, БЦ "Олимпик"

ZANUSSI

www.electrolux.com

126.2936.33

Free Manuals Download Website

<http://myh66.com>

<http://usermanuals.us>

<http://www.somanuals.com>

<http://www.4manuals.cc>

<http://www.manual-lib.com>

<http://www.404manual.com>

<http://www.luxmanual.com>

<http://aubethermostatmanual.com>

Golf course search by state

<http://golfingnear.com>

Email search by domain

<http://emailbydomain.com>

Auto manuals search

<http://auto.somanuals.com>

TV manuals search

<http://tv.somanuals.com>