

Cat. No. 12-2115 **B**  
**OWNER'S MANUAL**

Please read before using this equipment.

# High-Power In-Dash AM/FM Stereo Cassette

with Anti-Theft Detachable Faceplate

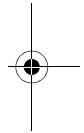
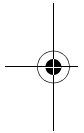

**RadioShack®**

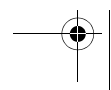
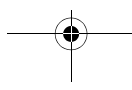

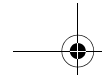

## FEATURES

---

Your RadioShack High-Power In-Dash AM/FM Stereo Cassette has many practical, easy-to-use features, and you can install it in almost any vehicle. The tuner's digital synthesized PLL (Phase-Locked Loop) circuitry gives you precise tuning and drift-free reception. The stereo's anti-theft control panel is easy to remove.

The auto-reverse cassette deck, memory tuning, and seek and scan tuning features all help make your stereo's operation simple and quick to help you drive safely.

**Caution:** Use common sense. Do not change your stereo's settings in heavy traffic or during hazardous driving conditions.

This stereo's features include:

**Anti-Theft Control Panel** — lets you quickly remove and store the stereo's control panel in the supplied carrying case. This discourages theft because the stereo cannot operate without the control panel.

**High Power** — provides 80 watts of total power to give you excellent audio response for all types of music.

**Auto-Reverse** — continuously plays both sides of a cassette tape.

**Auto-Search Music System** — automatically searches for the beginning of the previous or next track on the tape.

**Dolby® B Noise Reduction** — assures low noise music reproduction and a wide dynamic range.

**Manual/Automatic Memory Programming** — lets you manually or automatically store 18 FM and 12 AM stations into memory groups so you can quickly tune to those stations.

**Memory Scan Tuning** — scans all stations in an AM or FM memory group, playing each for 5 seconds.

**Seek Tuning** — searches forward or backward to the next strong station in the selected band. This makes finding a station quick and easy.

**RCA Line In Jacks** — let you connect an external portable CD player or a stand-alone CD changer/controller system to your stereo.

**RCA Line Out Connectors** — let you connect an optional amplifier to your stereo.

**Metal Tape Selector** — takes advantage of the improved sound quality of metal tapes.

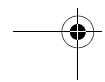
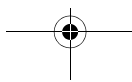

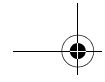

---

**Lock-In Fast-Forward/Rewind** — lets you quickly move the tape forward or backward.

**Advanced FM Optimizer Circuitry** — automatically adjusts the tuner's high-frequency response and stereo separation to give you the best possible sound, regardless of the signal level.

**Automatic FM Tuning Adjustment** — automatically changes FM reception on weak stations from stereo to mono, to improve reception of those stations.

**Lighted Liquid-Crystal Display with Clock** — lets you easily see the clock/radio/cassette deck's current functions.

**Digitally Synthesized Circuitry** — gives you precise tuning and drift-free reception.

**Mute** — lets you silence or restore sound with the push of a button.

**Reset** — lets you clear all stored stations.

**Built-In Noise Suppression Choke** — reduces the noise caused by your vehicle's electrical system.

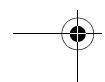
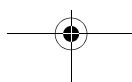
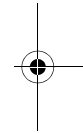
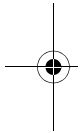

# CONTENTS

---

<b>Installation .....</b>	<b>5</b>
Before You Begin the Installation .....	5
Preparing the Mounting Area .....	5
Routing Speaker Wires .....	5
Using an Adapter Harness .....	6
Making the Connections .....	6
Connecting Ground, Power, and Optional Components .....	8
Connecting Two Pairs of Speakers .....	9
Connecting One Pair of Speakers .....	10
Connecting the Antenna .....	11
Completing the Connections .....	11
Testing the Connections .....	11
Removing the Shipping Screw .....	11
Mounting the Stereo .....	12
Removing the Stereo from the Dash .....	14
<b>Using the Control Panel .....</b>	<b>15</b>
Replacing the Control Panel .....	15
Removing the Control Panel .....	15
<b>Basic Operation .....</b>	<b>16</b>
Setting the Clock .....	16
Adjusting the Controls .....	16
Using the Auxiliary Source Input .....	17
<b>Radio Operation .....</b>	<b>18</b>
Playing the Radio .....	18
Memory Tuning .....	19
Manually Storing Stations .....	19
Automatically Storing Stations .....	19
Selecting a Stored Station .....	20
Scanning Stored Stations .....	20
<b>Cassette Player Operation .....</b>	<b>21</b>
Playing a Cassette .....	21
Fast-Forward and Rewind .....	22
Auto-Search Music System .....	22
<b>Care and Maintenance .....</b>	<b>23</b>
The FCC Wants You to Know .....	23
Cleaning the Tape-Handling Parts .....	24
Restoring Tape Tension and Sound Quality .....	24
Replacing a Fuse .....	24
<b>Specifications .....</b>	<b>26</b>

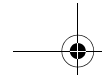

## INSTALLATION

---



### BEFORE YOU BEGIN THE INSTALLATION

Before you install your stereo, read all the instructions in this owner's manual. You should be able to answer these questions about your vehicle's electrical system:

- Which terminal in the vehicle's fuse box supplies power even when the ignition is off?
- Which terminal in the vehicle's fuse box is for accessories?
- How do I connect a wire to the fuse box?

Also, be aware that installation in your vehicle might require cutting or modifying your vehicle.

Place the stereo as close as possible to the selected mounting location. We recommend that you install the stereo by temporarily connecting it to ground and power, optional components, and your speakers. Then test the connections, disconnect the stereo, mount it in your vehicle, and reconnect it. The instructions in this manual are arranged in this order.

#### Cautions:

- For added safety and to protect your stereo, disconnect the cable from your vehicle's negative (-) battery terminal before you begin.

- Be sure your speakers can handle 20 watts of power output per channel. Each speaker must have an impedance of at least 4 ohms. Your local RadioShack store carries a full line of speakers.

### Preparing the Mounting Area

Before you mount the stereo, make sure you have all the necessary materials. Then confirm that the stereo fits your vehicle's mounting area. This stereo is a DIN-E size unit that requires a  $2\frac{1}{16}$ -inch high by  $7\frac{3}{16}$ -inch wide by  $6\frac{11}{16}$ -inch deep ( $53 \times 182 \times 170$  mm) mounting area.

**Caution:** Be sure to avoid obstructions behind the mounting surface.

**Note:** If the mounting area is larger than the stereo requires, you might be able to mount the stereo with an in-dash installation kit, available at your local RadioShack store. Follow the installation kit's instructions to mount the stereo.

### Routing Speaker Wires

If you install speakers, avoid routing the speaker wires near moving parts or sharp edges. You can usually route wires along the wiring channel beneath the vehicle's door facings by carefully removing the molding that holds the carpet in place. After you route the wires, replace the molding.

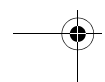
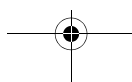
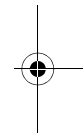
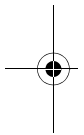

## Using an Adapter Harness

If you are replacing an existing stereo, or if your vehicle has been factory-wired for autosound components, you can use an adapter harness to connect the power and speakers. RadioShack stores sell adapter harnesses for most vehicles.

Follow the directions that come with the adapter harness to temporarily connect the power and speakers.

After you connect the adapter harness to your vehicle, you can skip to "Testing the Connections" on Page 11.

## MAKING THE CONNECTIONS

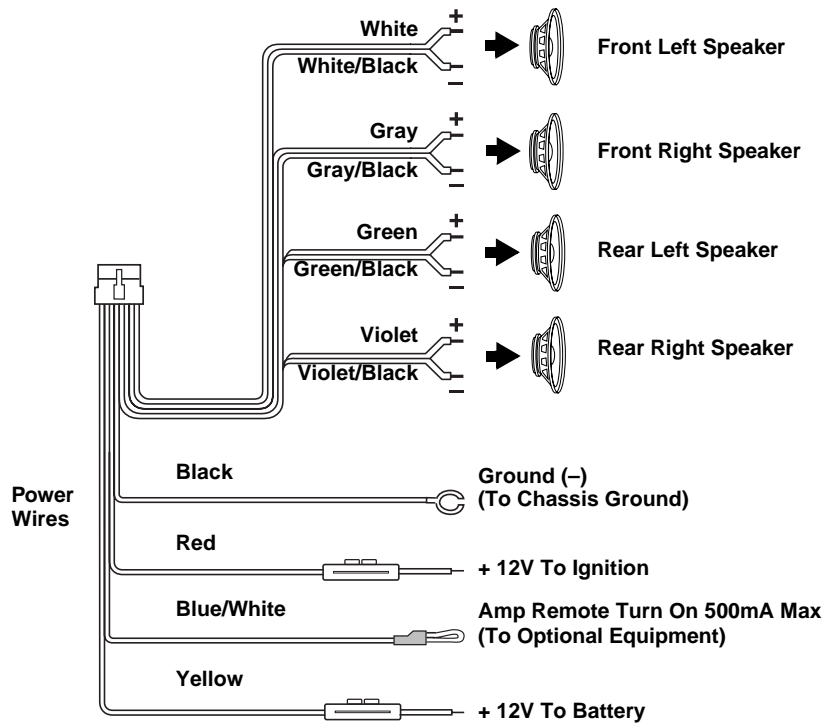

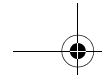

---

The supplied wiring harness with its 14-pin connector includes all the lead wires you need to connect the stereo to ground, power, some optional components, and speakers.

**Important:** Do not cut these wires. If you cut any wire, you cannot obtain a refund or exchange on this product. RadioShack will provide warranty service if you cut a wire and find the product is defective.

You might need additional wire to complete the connections, depending on your individual auto sound system. Your local RadioShack store carries a full line of wire and wire management accessories.

**Cautions:**

- You *must* connect the GROUND, +12V TO IGNITION, and +12V TO BATTERY wires first, then make all other connections as described in the following sections before you plug the wiring harness into the stereo. If you do not make the connections in the order shown, an incorrect connection could damage the stereo.
- You must connect a separate wire to each speaker terminal as described in “Connecting Two Pairs of Speakers” on Page 9 or “Connecting One Pair of Speakers” on Page 10. Do not use a common wire or chassis ground for any speaker connection.

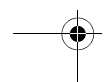
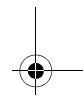
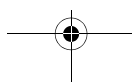
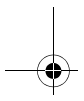
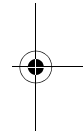
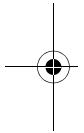

## Connecting Ground, Power, and Optional Components

Follow these steps to connect the wiring harness to ground, power, clock memory, and optional components.

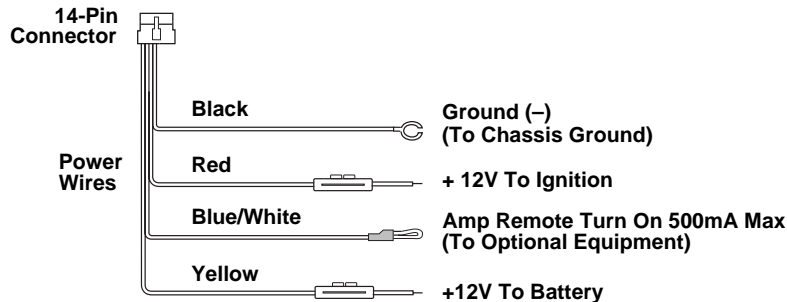

1. Disconnect the cable from your vehicle's negative (-) battery terminal.
2. Connect the black ground wire to a chassis ground, such as a metal screw attached to a metal part of the vehicle's frame. Be sure the screw is not insulated from the chassis by a plastic or rubber part.
3. Connect the red +12V To Ignition wire (with in-line fuse holder) to a point in your vehicle's fuse block that has power only when you turn the vehicle's key to either the accessory (ACC) or START position.

This connection turns on the stereo when you turn on the ignition or turn the key to ACC, and turns off the stereo when you turn off the ignition. This prevents your vehicle's battery from being drained if you leave the stereo on when you turn off the ignition.

4. Connect the yellow +12V To Battery wire (with in-line fuse holder) to your

vehicle's positive (+) battery terminal or to a point in your vehicle's fuse block that provides a continuous source of 12 volts. This connection provides power for the stereo's components (such as the clock), and continuous power for the stereo's memory when the ignition is off.

5. Connect the blue/white wire to any optional equipment (designed to run from a switched source) that you want the stereo to turn on and off (such as a remote amplifier or a power antenna).

This wire does not provide power to the components. It simply turns them on or off. If you do not use this wire, secure it with a wire tie and do not let it touch metal.

**Note:** To connect an optional amplifier, use the line out connectors on the back of your car stereo and follow the instructions in the amplifier's owner's manual.



## Connecting Two Pairs of Speakers

If you are using both front and rear speakers, follow these steps to connect the wiring harness to the speakers.

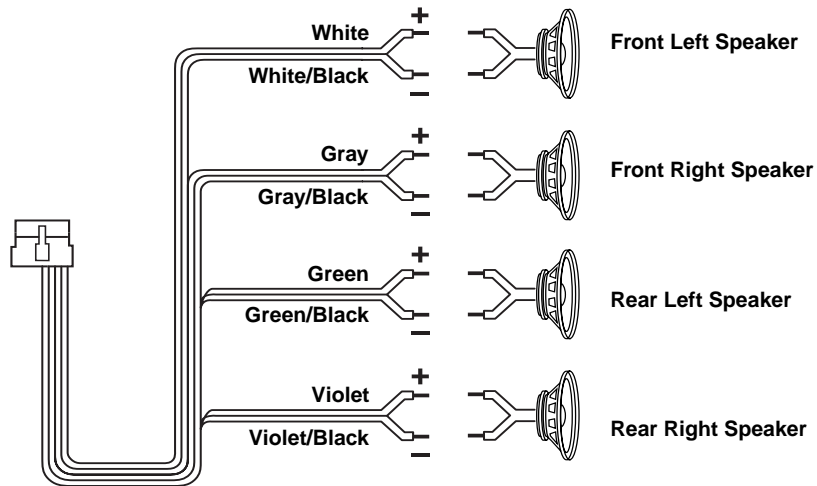

1. Connect the gray wire to the right front speaker's positive terminal. This terminal is usually marked with a plus (+) sign or red mark.
2. Connect the gray/black wire to the right front speaker's negative terminal. This terminal might be marked with a minus (-) sign or it might not be marked at all.
3. Connect the white wire to the left front speaker's positive terminal.
4. Connect the white/black wire to the left front speaker's negative terminal.
5. Connect the violet wire to the right rear speaker's positive terminal.
6. Connect the violet/black wire to the right rear speaker's negative terminal.
7. Connect the green wire to the left rear speaker's positive terminal.
8. Connect the green/black wire to the left rear speaker's negative terminal.

## Connecting One Pair of Speakers

If you are using only one pair of speakers, follow these steps to connect the wiring harness to the speakers.

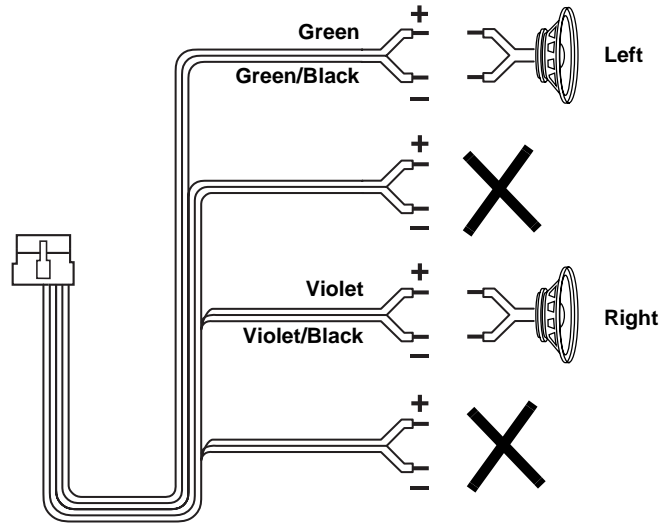

1. Connect the violet wire to the right speaker's positive terminal. This terminal is usually marked with a plus (+) sign or red mark.
2. Connect the violet/black wire to the right speaker's negative terminal. This terminal might be marked with a minus (-) sign or it might not be marked at all.
3. Connect the green wire to the left speaker's positive terminal.
4. Connect the green/black wire to the left speaker's negative terminal.

**Note:** Be sure to secure all unused wires with wire ties and do not let them touch metal.

## Connecting the Antenna

Connect the vehicle's antenna cable to the stereo's antenna socket.

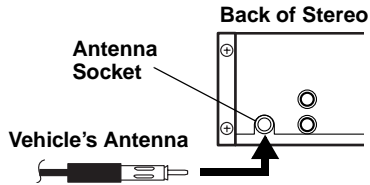

## Completing the Connections

After you have securely made all connections, plug the wiring harness' connector into the stereo's 14-pin wiring socket.

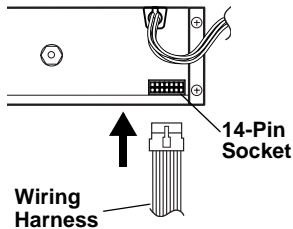

Then reconnect the cable to the vehicle's negative battery terminal.

## TESTING THE CONNECTIONS

Turn on your vehicle's ignition and install your stereo's control panel (see "Replacing the Control Panel" on Page 15). Press **PWR** to turn on the stereo. The display should light and the currently set time (or **12:00**) should appear.

If the stereo does not work, **immediately turn off your vehicle's ignition and disconnect the wiring harness' connector.** Then recheck your connections.

After you verify that the display lights, follow the instructions in "Removing the Shipping Screw."

## REMOVING THE SHIPPING SCREW

The shipping screw helps protect the stereo's cassette player from being damaged during shipment.

Before you mount the stereo, use a Phillips screwdriver to remove the screw, spacer, and rubber washer from the top of the stereo. This will allow you to remove the mounting sleeve from the stereo when you mount it.

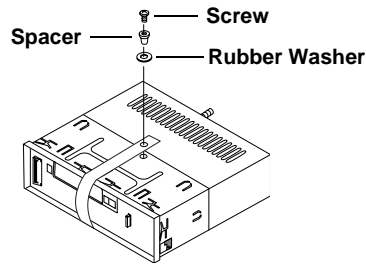

**Note:** Save the screw, spacer, and rubber washer, and replace them if you ship the stereo. You can store them by taping them to the back of the stereo.

## MOUNTING THE STEREO

Once you verify that the stereo is connected properly, follow these steps to mount the stereo.

1. Disconnect the cable from the vehicle's negative (-) battery terminal.
2. Disconnect the wiring harness and the antenna.

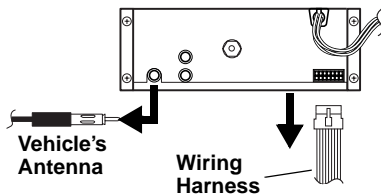

3. Press **REL** on the right side of the control panel to remove it (see "Removing the Control Panel" on Page 15).
4. With the supplied keys' tabs facing inward, insert both of the keys into the slots between the mounting sleeve and the stereo and press the keys toward the back of the stereo. The sleeve begins to slide off.

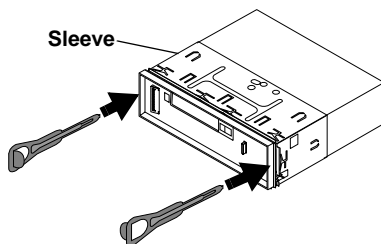

5. Remove the keys from the slots and slide the sleeve all the way off.

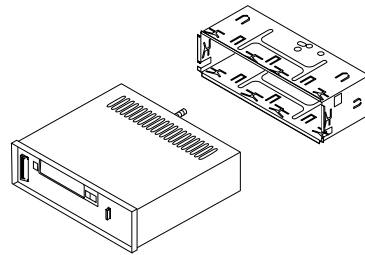

6. Put the sleeve into the opening in the dash, then secure it by bending out all the tabs with a screwdriver.

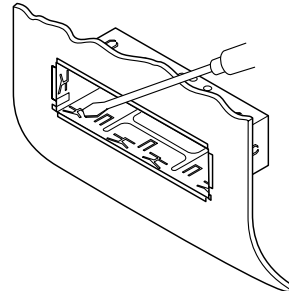

7. Pull the wiring harness and the antenna cable through the sleeve and dash, then reconnect the wiring harness and the antenna to the stereo.

- Slide the stereo into the sleeve until it locks into place.

If you are securing the stereo in an existing mounting hole in the dash, push the mounting bolt covered with the rubber mounting grommet through the existing mounting hole and make sure it is secure.

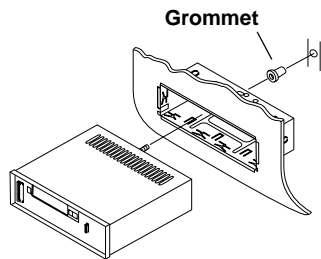

**Note:** If the mounting bolt is too short to reach the mounting hole, remove the rubber mounting grommet and screw the supplied mounting bolt extender onto the mounting bolt. Then push the rubber grommet onto the end of the bolt extender.

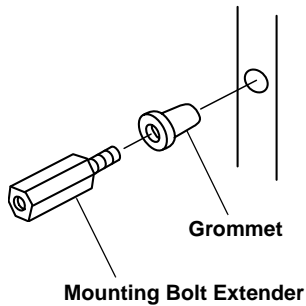

Otherwise, you can remove the rubber mounting grommet and use the extender and the supplied nut and washer to attach the supplied metal strap to the mounting bolt on the back of the stereo. If necessary, bend the metal strap to fit your vehicle's mounting area. Then use the supplied sheet metal screw to attach another section of the strap to a solid metal part of the vehicle under the dashboard. This strap also helps ensure proper electrical grounding of the stereo.

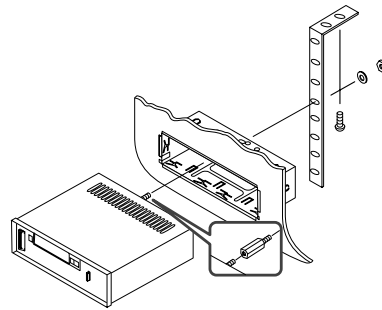

- Snap the plastic collar onto the front of the stereo.

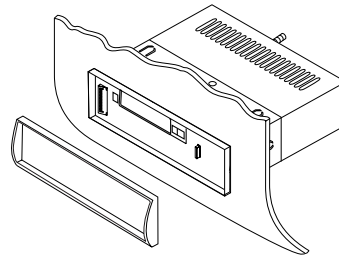

- Install your stereo's control panel (see "Replacing the Control Panel" on Page 15).

11. Reconnect the cable to the vehicle's negative (-) battery terminal.

**Note:** You will need to set the stereo's clock after you reconnect the cable to the vehicle's battery (see "Setting the Clock" on Page 16).

## REMOVING THE STEREO FROM THE DASH

Follow these steps to remove the stereo from the dash.

1. Disconnect the cable from the vehicle's negative (-) battery terminal.
2. If you secured the stereo to an existing mounting hole under the dash, slide out the stereo to free the mounting bolt from the mounting hole.

Or, remove the nut holding the metal strap to the back of the stereo.

3. Press **REL** to remove the stereo's control panel.
4. Snap the plastic collar off of the front of the stereo.

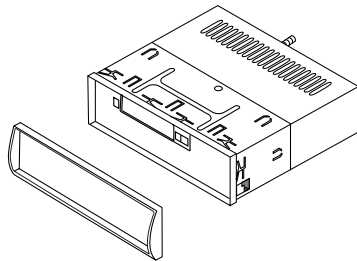

5. With the supplied keys' tabs facing inward, insert both of the keys into the slots between the mounting

sleeve and the stereo and press the keys toward the back of the stereo. The stereo is loosened from the sleeve.

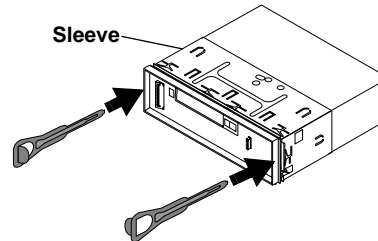

6. Remove the keys from the slots and slide the stereo all the way out of the sleeve.
7. Disconnect the wiring harness and the antenna.
8. Reconnect the cable to the vehicle's negative (-) battery terminal.

## USING THE CONTROL PANEL

The stereo's control panel must be in place for the stereo to operate. When you remove it, the stereo does not work. This is a simple but effective security measure.

Any stored stations remain in memory when the control panel is removed.

## REPLACING THE CONTROL PANEL

1. Insert the left end of the control panel into the left edge of the recess. Slide the holes in the end of the control panel over the two tabs in the recess.

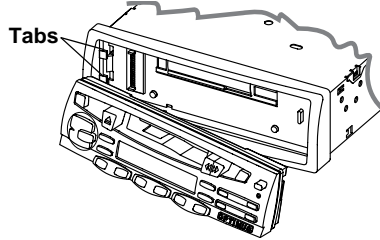

2. Gently push the right edge of the control panel into the recess until you hear a click.

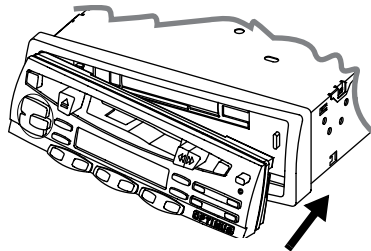

## REMOVING THE CONTROL PANEL

1. Press **REL** and the right end pops out slightly.

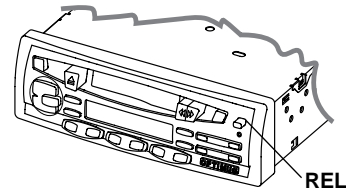

2. Slide the right end out first, then grasp the control panel and pull it out to remove it.

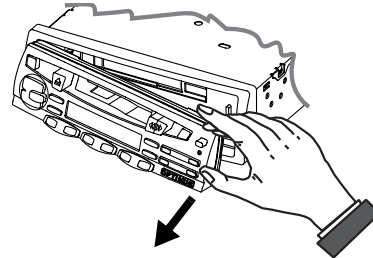

3. Store the control panel in the supplied carrying case.

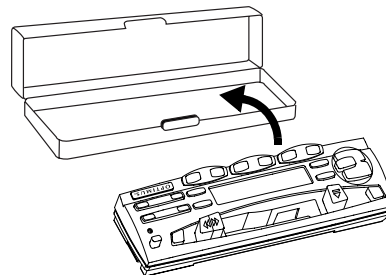

## BASIC OPERATION

### SETTING THE CLOCK

**Note:** You can set the clock only when the vehicle's ignition is turned on or set to ACC.

1. Hold down **F/C** (Frequency/Clock) until the hour digit(s) blink(s), then repeatedly press **+** or **-** until the correct hour appears.
2. Press **F/C** again. The minute digits blink. Repeatedly press **+** or **-** until the correct minute appears.
3. Press **F/C** again to store the time.

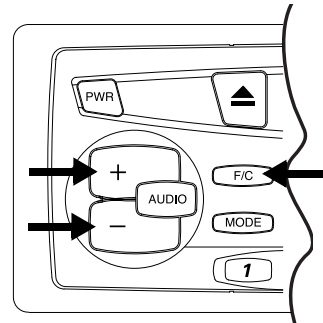

### ADJUSTING THE CONTROLS

When you listen to your stereo, you can adjust the following controls to suit your listening preferences.

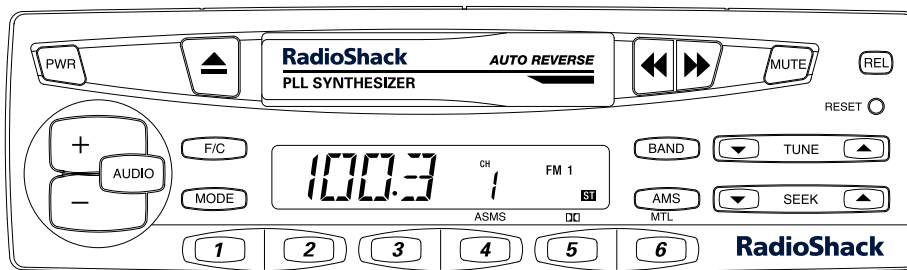

**+ / -** — Repeatedly press to increase (+) or decrease (-) the volume. **VOL :** and the volume level appear (such as **VOL : 12**). The volume level ranges from 0 to 40. The display automatically returns to the time display about 5 seconds after you finish adjusting the sound.

**Warning:** To protect your hearing, do not listen at high volume levels. Slowly increase the volume to a comfortable listening level.

**AUDIO** — Repeatedly press until **BAS**, **TRE**, **BAL**, **FAD**, or **VOL** and the current level appear, then press **+** or **-** within 5 seconds to change the stereo's bass, treble, balance, or fader settings.



**Notes:**

- When you adjust the balance toward the left speakers (by pressing **-**), **L** and the left balance level appear (such as **L5**). When you adjust the balance toward the right speakers (by pressing **+**), **R** and the right balance level appear (such as **R3**).
- When you adjust the fader toward the front speakers, **F** and the front fader level appear. When you adjust the fader toward the rear speakers, **R** and the rear fader level appear.
- If **BAS**, **TRE**, **BAL**, **FAD**, or **VOL** and the number disappear before you press **+** or **-**, repeatedly press **AUDIO** until the setting you want reappears, then repeatedly press **+** or **-** to change the setting.

**MUTE** — Press to temporarily silence the stereo. **MUTE** appears. To restore the sound, press **MUTE** again.

## USING THE AUXILIARY SOURCE INPUT

If you used the input jacks on the back of the stereo to connect it to an external source such as a portable CD player or stand-alone CD changer/controller system, follow these steps to listen to that external source.

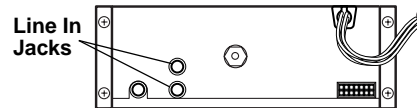

1. With the stereo on, press **MODE** once. **CD** appears.

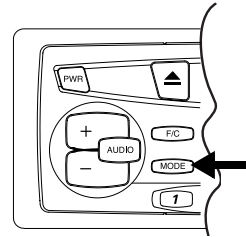

2. Turn on the external sound source.
3. Adjust the volume, bass, treble, balance, and fader settings to suit your listening preference.
4. Press **MODE** again until **CD** disappears to listen to this stereo's radio or tape player.

## RADIO OPERATION

### PLAYING THE RADIO

1. Press **PWR** to turn on the stereo.

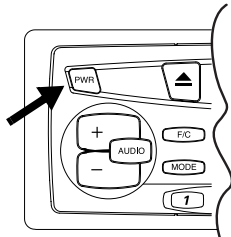

2. Press **BAND** to select the AM or FM band. **AM 1** or **AM 2** appears when you select an AM band. **FM 1**, **FM 2**, or **FM 3** appears when you select an FM band.

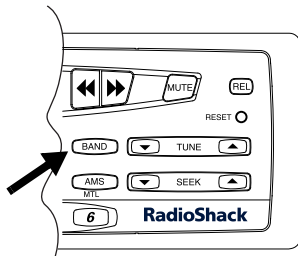

#### Notes:

- Each time you press **BAND**, the radio tunes to the last station selected in the current band and memory group (see "Memory Tuning" on Page 19).
  - **ST** appears when an FM signal is received in stereo.
3. Tune to the desired station in one of the following ways.

**Manual Tuning:** Repeatedly press **TUNE ▲** or **TUNE ▼** to tune down or up the selected band.

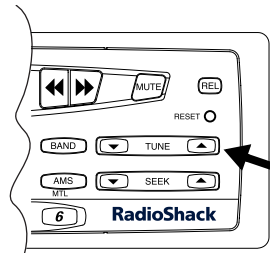

**Seek Tuning:** Press **SEEK ▼** or **SEEK ▲** to tune to the next lower or higher station.

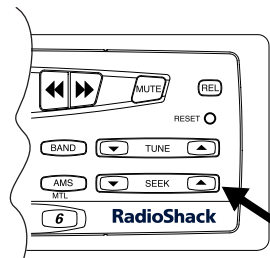

**Note:** If the stereo does not find a strong station when seeking, it searches the band again for weaker stations. If no station is found, press **TUNE ▼** or **TUNE ▲** to stop the seek function.

4. Press **+** or **-** to increase or decrease the volume as desired.

#### Notes:

- See "Adjusting the Controls" on Page 16 for information about changing the stereo's other settings.

- To temporarily display the frequency of the station currently playing, press **F/C**. The display shows the frequency for about 5 seconds, then returns to the clock display.

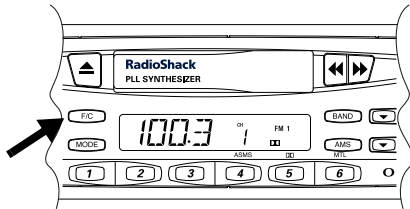

## MEMORY TUNING

You can manually store up to 12 AM and 18 FM stations in memory groups. Each memory group (AM 1, AM 2, FM 1, FM 2, and FM 3) holds up to six stations. You can also automatically store stations into a memory group.

To clear all the previously stored stations and the clock setting, use the tip of a pen or a straightened paper clip to press **RESET**.

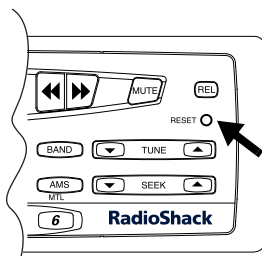

To store different stations, follow the instructions in "Manually Storing Stations" or "Automatically Storing Stations." To set the clock, see "Setting the Clock" on Page 16.

## Manually Storing Stations

- Repeatedly press **BAND** to select the desired memory group (**AM 1** or **AM 2** for AM, or **FM 1**, **FM 2**, or **FM 3** for FM).
- Tune to the station you want to store.
- Hold down the desired memory location button until the frequency and **CH** with the selected button number appear. The volume momentarily mutes while the radio stores the station.

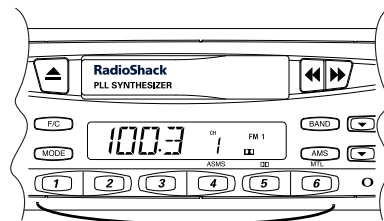

Memory Location Buttons

## Automatically Storing Stations

- Repeatedly press **BAND** to select the memory group where you want to store stations. For example, to store the first group of AM stations into AM 1, repeatedly press **BAND** until **AM 1** appears.

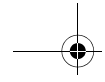

2. Hold down **AMS** (automatic memory scan) for about 3 seconds. The stereo scans the selected band and stores the first six stations it finds (starting with the currently tuned frequency).

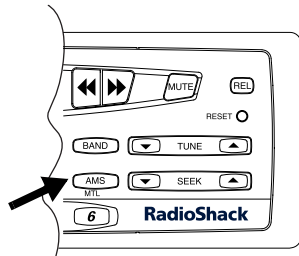

The frequency, memory group, and memory location number appear for each station as it is stored. Then, after the stereo scans the band once, it tunes to the last stored station and begins to play.

3. To stop the stereo from searching for stations before it automatically stops, briefly press **AMS**.

**Note:** If a station has a weak signal or interference, the stereo might not store it automatically. If this happens, you can manually store the station.

## Scanning Stored Stations

The stereo's automatic memory scan (AMS) feature scans all stored stations in a selected memory group, pausing for 5 seconds at each stored station.

1. Press **BAND** until the stereo displays the memory group you want to scan.
2. To start automatic memory scan, briefly press **AMS**. As each stored frequency plays, the current memory location number flashes. (Do not hold down **AMS**. This causes the radio to automatically seek for and store six stations into the selected memory group.)
3. To stop scanning when the stereo pauses at a station, briefly press **AMS**. Otherwise, the stereo continues to scan the memory group.

## Selecting a Stored Station

To select a stored station, press **BAND** to select the correct memory group. Then briefly press the desired memory location button. (Do not hold down the memory location button. This erases the previously stored station and stores the currently tuned station into that location.)

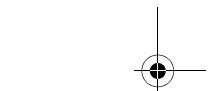
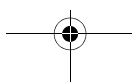

# CASSETTE PLAYER OPERATION

## PLAYING A CASSETTE

**Caution:** We recommend using C-60 or C-90 cassette tapes. Avoid using C-120 cassette tapes. They are very thin and can easily become tangled in the tape-handling parts.

Follow these steps to play a tape.

1. Take up any slack by turning the cassette's hub with your finger or a pencil. Avoid touching the tape.

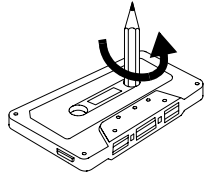

2. Insert the tape into the cassette compartment with its open edge to the right.

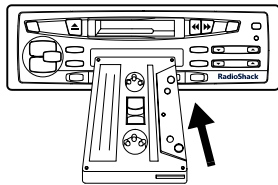

The tape begins to play, and the direction indicator (▶ or ◀) appears.

3. If you are playing a metal tape, press **MTL** until **MTL** appears on the display.

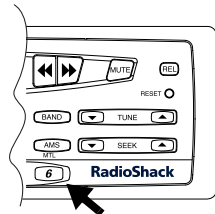

4. If you are playing a tape encoded with the Dolby B NR system, press **DB**. **DB** appears.

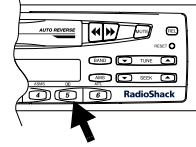

Press **DB** again when you finish playing a Dolby tape.

5. Adjust the volume, bass, treble, balance, and fader settings as desired.

### Notes:

- When the tape reaches the end of one side, the cassette player automatically changes the tape's direction and plays the other side of the tape.
- During play, you can switch to the other side of the cassette by pressing **◀** and **▶** at the same time until the indicator on the display changes direction.

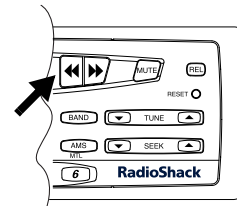

6. Press **▲** to stop and eject the tape.

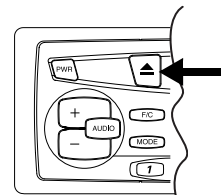

**Caution:** We recommend you press ▲ and eject the tape before you leave your vehicle. This releases the tape from the tape-handling parts and reduces the possibility of a tape being tangled or damaged.

## FAST-FORWARD AND REWIND

To fast-forward or quickly rewind the current side, press ►► or ◀◀. The tape quickly winds.

**Note:** Check the direction indicator on the display. To fast-forward, press the arrow key that points in the same direction. To rewind, press the arrow key that points in the opposite direction.

Play resumes when the tape reaches the end of that side.

To stop fast-forward or rewind, gently press and release the opposite button. Play continues.

## AUTO-SEARCH MUSIC SYSTEM

The ASMS (Auto-Search Music System) feature lets you quickly advance the tape to the beginning of the next track, or rewind the tape to the beginning of the preceding track, and automatically start play at that track.

To use the Auto-Search Music System feature, press **ASMS** so **ASMS** appears, then press ►► search for and play the next track, or ◀◀ to search for and play the preceding track.

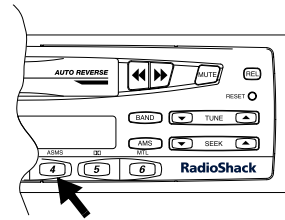

Repeat this process until you hear the track you want to play, then press **ASMS** again to turn off the Auto-Search Music System feature. **ASMS** disappears.

### Notes:

- If you do not turn off the ASMS feature after you find the track you want to play, the stereo will not rewind or fast-forward the tape more than one track at a time.
- When you press ◀◀, if a track has been playing longer than 10 seconds, the stereo searches for the beginning of the current track. However, if the track has just begun or it has not yet started, the stereo searches for the beginning of the preceding track.

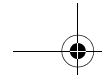

## CARE AND MAINTENANCE

---

Your RadioShack High-Power In-Dash AM/FM Stereo Cassette is an example of superior design and craftsmanship. The following suggestions will help you care for your stereo so you can enjoy it for years.



Keep the stereo dry. If it gets wet, wipe it dry immediately. Liquids might contain minerals that can corrode the electronic circuits.



Keep the stereo away from dust and dirt, which can cause premature wear of parts.



Handle the stereo gently and carefully. Dropping it can damage circuit boards and cases and can cause the stereo to work improperly.



Wipe the stereo with a damp cloth occasionally to keep it looking new. Do not use harsh chemicals, cleaning solvents, or strong detergents to clean the stereo.

Modifying or tampering with the stereo's internal components can cause a malfunction and might invalidate its warranty and void your FCC authorization to operate it. If your stereo is not performing as it should, take it to your local RadioShack store for assistance.

## THE FCC WANTS YOU TO KNOW

Your stereo might cause TV or radio interference even when it is operating properly. To determine whether your stereo is causing the interference, turn off your stereo. If the interference goes away, your stereo is causing it. Try to eliminate the interference by:

- Moving your stereo away from the receiver
- Contacting your local RadioShack store for help

If you cannot eliminate the interference, the FCC requires that you stop using your stereo.

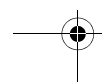
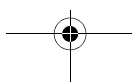

## CLEANING THE TAPE-HANDLING PARTS

Clean the tape head after about every 20 hours of playing time. Insert a special head-cleaning cassette (available at your local RadioShack store), and follow the cleaning cassette's directions to clean the tape head.

## RESTORING TAPE TENSION AND SOUND QUALITY

After you play a cassette tape a few times, the tape might become tightly wound on the reels. This can cause playback sound quality to deteriorate.

To restore the sound quality, fast-forward the tape from the beginning to the end of one side, then completely rewind it. Then loosen the tape reels by gently tapping each side of the cassette's outer shell on a flat surface.

**Caution:** Be careful not to damage the cassette when tapping it. Do not touch the exposed tape or allow any sharp objects near the cassette.

## REPLACING A FUSE

If the clock resets or stored stations are lost when the ignition is off, you might need to replace the yellow clock memory wire's fuse. Use a standard 1<sup>1</sup>/<sub>4</sub>-inch (30 mm) 12 amp fuse, available from your local RadioShack store (a spare fuse is supplied).

If the stereo does not operate, you might need to replace the red power lead wire's fuse. Use a standard 1<sup>1</sup>/<sub>4</sub>-inch (30 mm) 0.5 amp fuse, available from your local RadioShack store (a spare fuse is supplied).

**Caution:** Make sure you replace a fuse only with another fuse of the same rating.

Follow these steps to check and replace each fuse.

1. Disconnect the cable from the vehicle's negative (-) battery terminal.
2. To open a fuse holder, pull the latches apart until it opens. Then, to remove the fuse, gently pull the fuse off of both fuse clips inside the fuse holder.

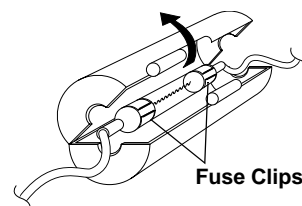

3. If the fuse is blown, replace it with a fuse of the same rating.



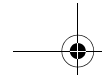

- 
4. Reassemble the fuse holder by placing the wires and the fuse clips back inside the holder, then squeeze it together until it snaps shut.

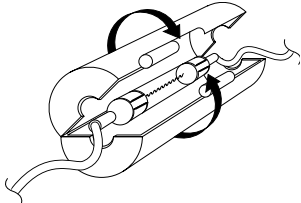

5. Reconnect the cable to the vehicle battery's negative (-) terminal.
6. Reset your stereo's clock and memory settings.

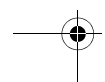
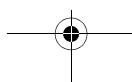
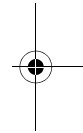
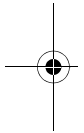

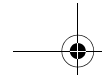

# SPECIFICATIONS

## RADIO

	<b>FM (Nominal)</b>	<b>AM (Nominal)</b>
Frequency Range	88–108 MHz	530–1710 kHz
IF Rejection	75 dB	50 dB
Image Rejection	44 dB	55 dB
Selectivity	60 dB	35 dB
Signal-to-Noise (S/N) Ratio	60 dB	48 dB
Stereo Separation	32 dB	—
Usable Sensitivity	10 dB- $\mu$ V (3.15%THD)	24 dB- $\mu$ V (20 dB S/N)

## CASSETTE PLAYER

Cassette Mechanism	Auto-Reverse
Wow and Flutter	0.2% WRMS
Signal-to-Noise Ratio	48 dB
Separation	35 dB
Frequency Response (-3 dB)	40–12,500 Hz
Dolby Noise Reduction Effect	10 dB

## GENERAL

Power Source	14.4 V DC Negative Ground
Bass Control Effects	$\pm 11$ dB at 100 Hz
Treble Control Effects	$\pm 11$ dB at 10 kHz
Speaker Output Impedance	4 or 8 Ohms
Maximum Power	30 Watts/Channel (With 4 Speakers)
Power Output (10% THD @ 1 kHz)	20 Watts RMS/Channel (With 4 Speakers)
Chassis Size (HWD)	$1^{15/16} \times 7 \times 5^{7/8}$ Inches (50 $\times$ 178 $\times$ 150 mm)
Weight	4 lbs 6 oz (2 kg)

Specifications are typical; individual units might vary. Specifications are subject to change and improvement without notice.



# NOTES

---

---

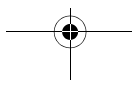
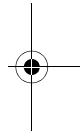
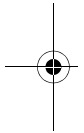

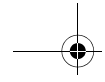

### Limited One-Year Warranty

This product is warranted by RadioShack against manufacturing defects in material and workmanship under normal use for one (1) year from the date of purchase from RadioShack company-owned stores and authorized RadioShack franchisees and dealers. EXCEPT AS PROVIDED HEREIN, RadioShack MAKES NO EXPRESS WARRANTIES AND ANY IMPLIED WARRANTIES, INCLUDING THOSE OF MERCHANTABILITY AND FITNESS FOR A PARTICULAR PURPOSE, ARE LIMITED IN DURATION TO THE DURATION OF THE WRITTEN LIMITED WARRANTIES CONTAINED HEREIN. EXCEPT AS PROVIDED HEREIN, RadioShack SHALL HAVE NO LIABILITY OR RESPONSIBILITY TO CUSTOMER OR ANY OTHER PERSON OR ENTITY WITH RESPECT TO ANY LIABILITY, LOSS OR DAMAGE CAUSED DIRECTLY OR INDIRECTLY BY USE OR PERFORMANCE OF THE PRODUCT OR ARISING OUT OF ANY BREACH OF THIS WARRANTY, INCLUDING, BUT NOT LIMITED TO, ANY DAMAGES RESULTING FROM INCONVENIENCE, LOSS OF TIME, DATA, PROPERTY, REVENUE, OR PROFIT OR ANY INDIRECT, SPECIAL, INCIDENTAL, OR CONSEQUENTIAL DAMAGES, EVEN IF RadioShack HAS BEEN ADVISED OF THE POSSIBILITY OF SUCH DAMAGES.

Some states do not allow limitations on how long an implied warranty lasts or the exclusion or limitation of incidental or consequential damages, so the above limitations or exclusions may not apply to you.

In the event of a product defect during the warranty period, take the product and the RadioShack sales receipt as proof of purchase date to any RadioShack store. RadioShack will, at its option, unless otherwise provided by law: (a) correct the defect by product repair without charge for parts and labor; (b) replace the product with one of the same or similar design; or (c) refund the purchase price. All replaced parts and products, and products on which a refund is made, become the property of RadioShack. New or reconditioned parts and products may be used in the performance of warranty service. Repaired or replaced parts and products are warranted for the remainder of the original warranty period. You will be charged for repair or replacement of the product made after the expiration of the warranty period.

This warranty does not cover: (a) damage or failure caused by or attributable to acts of God, abuse, accident, misuse, improper or abnormal usage, failure to follow instructions, improper installation or maintenance, alteration, lightning or other incidence of excess voltage or current; (b) any repairs other than those provided by a RadioShack Authorized Service Facility; (c) consumables such as fuses or batteries; (d) cosmetic damage; (e) transportation, shipping or insurance costs; or (f) costs of product removal, installation, set-up service adjustment or reinstallation.

This warranty gives you specific legal rights, and you may also have other rights which vary from state to state.

RadioShack Customer Relations, 200 Taylor Street, 6th Floor, Fort Worth, TX 76102

*We Service What We Sell*

12/99

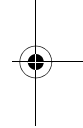
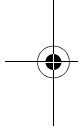

**RadioShack**  
**A Division of Tandy Corporation**  
**Fort Worth, Texas 76102**

4301-3858-2  
Printed in China

04A00

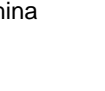
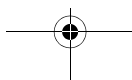

## Free Manuals Download Website

<http://myh66.com>

<http://usermanuals.us>

<http://www.somanuals.com>

<http://www.4manuals.cc>

<http://www.manual-lib.com>

<http://www.404manual.com>

<http://www.luxmanual.com>

<http://aubethermostatmanual.com>

Golf course search by state

<http://golfingnear.com>

Email search by domain

<http://emailbydomain.com>

Auto manuals search

<http://auto.somanuals.com>

TV manuals search

<http://tv.somanuals.com>