

**SONY**

3-755-296-22 (3)

Video Camera Recorder **8**

# CCD-FX310

## Operation Manual

Before operating the unit, please read this manual thoroughly and retain it for future reference.

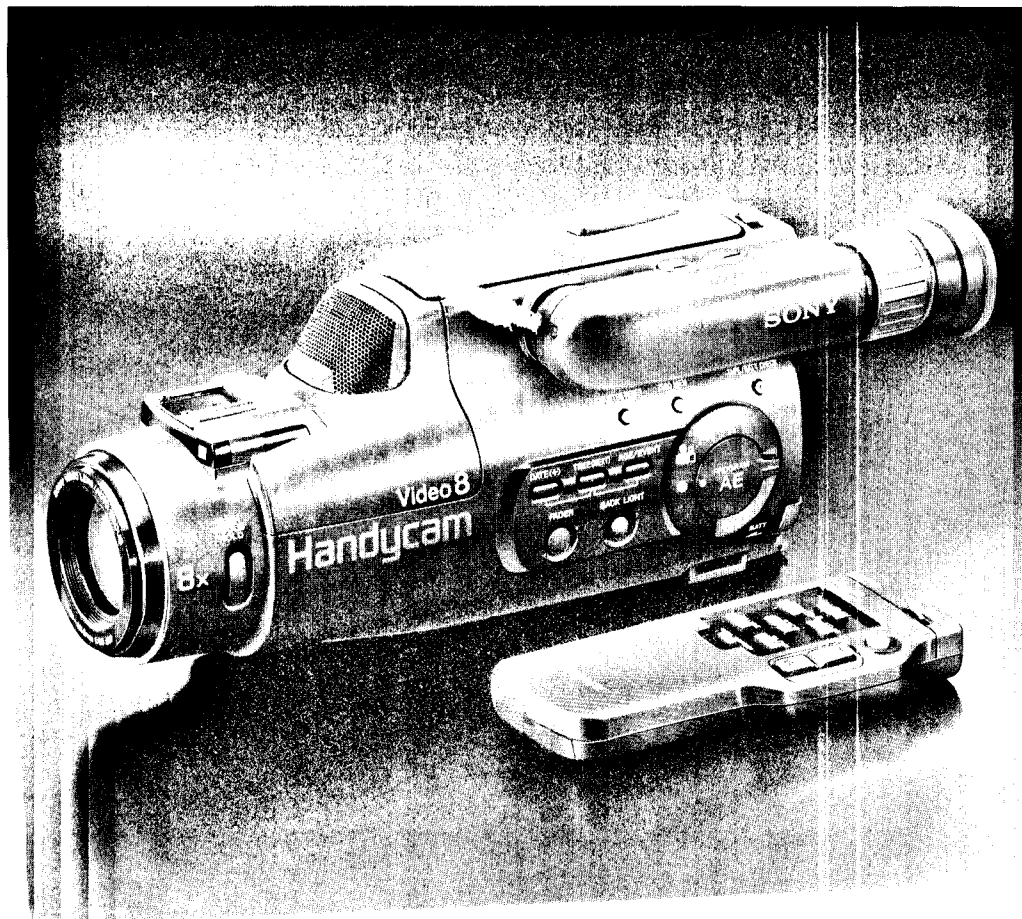

**Video 8 Handycam**

## WARNING

**To prevent fire or shock hazard, do not expose the unit to rain or moisture.**

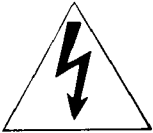
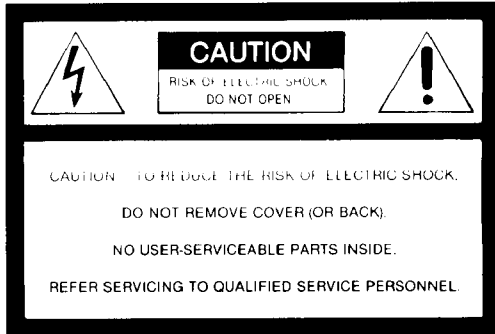

This symbol is intended to alert the user to the presence of uninsulated "dangerous voltage" within the product's enclosure that may be of sufficient magnitude to constitute a risk of electric shock to persons.



This symbol is intended to alert the user to the presence of important operating and maintenance (servicing) instructions in the literature accompanying the appliance.

### Information for the customers in the U.S.A.

This equipment generates and uses radio frequency energy and if not installed and used properly, that is, in strict accordance with the manufacturer's instructions, may cause interference to radio and television reception. It has been type tested and found to comply with the limits for a Class B computing device in accordance with the specifications in Subpart J of Part 15 of FCC Rules, which are designed to provide reasonable protection against such interference in a residential installation. However, there is no guarantee that interference will not occur in a particular installation. If this equipment does cause interference to radio or television reception, which can be determined by turning the equipment off and on, the user is encouraged to try to correct the interference by one or more of the following measures:

- Reorient the receiving antenna
- Relocate the equipment with respect to the receiver
- Move the equipment away from the receiver
- Plug the equipment into a different outlet so that equipment and receiver are on different branch circuits.

If necessary, the user should consult the dealer or an experienced radio/television technician for additional suggestions. The user may find the following booklet prepared by the Federal Communications Commission helpful:

"How to Identify and Resolve Radio-TV Interference Problems".

This booklet is available from the U.S. Government Printing Office, Washington, DC 20402, Stock No. 004-000-00345-4.

#### Notice for the customers in Canada

This apparatus complies with the Class B limits for radio noise emissions set out in Radio Interference Regulations.

## Owner's Record

The model and serial numbers are located on the bottom. Record the serial number in the space provided on the right hand. Refer to these numbers whenever you call upon your Sony dealer regarding this product.

Model No. CCD-FX310  
Serial No. \_\_\_\_\_

# Table of Contents

## Before You Begin

About this manual .....	4
Checking supplied accessories .....	5
Before you start .....	5

### Chapter 1

## Getting Started

Charging and installing the battery pack .....	6
Inserting a tape .....	8
Preventing accidental erasure .....	8
Adjusting the viewfinder lens .....	9
Using the viewfinder as a sports finder .....	9
Installing the lithium battery .....	10
Setting the date and time .....	11
Storing a birth date in your camcorder .....	12

### Chapter 2

## Basic Camera Operation

How to record .....	14
Using Zooming Features .....	16
Playing Back a tape .....	17
Using the remote commander .....	19
Getting the most out of your battery pack .....	20

### Chapter 3

## Advanced Camera Operation

Connecting alternative power sources .....	22
Using house current .....	22
Using car battery .....	23
Camera recording .....	24
Recording the date or time .....	24
Putting an AGE on your tape .....	24
For low-position recording .....	25
Checking the last portion of a scene you just recorded (Rec Review) .....	26
Checking recording in the viewfinder (EDITSEARCH) .....	26
Re-recording on a previously recorded portion (EDITSEARCH) .....	27
Helpful hints for recording .....	27
Inserting a scene in the middle of a recorded tape .....	28
Recording with an external microphone .....	29
Connecting a wired remote control unit .....	29
Manual adjustments .....	30
Maintaining Focus .....	30
Compensating for backlighting .....	30
Using program AE (Auto Exposure) .....	31
Selecting the PROGRAM AE Mode .....	31
Fade-in and fade-out .....	32
Playing back .....	33
Editing .....	37

### Chapter 4

## Additional Information

Maintenance information .....	39
Tips for better camera recording .....	41
Identifying the parts .....	44
Indicators inside the viewfinder .....	48
Trouble check .....	49
Specifications .....	51
Index .....	Back cover

## Welcome to Video 8

Congratulations on your purchase of this Sony Handycam ® camcorder. With your Handycam you can capture life's precious moments with superior picture and sound quality. Your Handycam is loaded with advanced features, but at the same time it is very easy to use. You will soon be producing home video that you can enjoy for years to come.

### About This Manual

This manual shows you how to operate your camcorder. To get the most out of the features of your Handycam, we recommend you read this manual thoroughly before using. But if you want to shoot as soon as possible, please read the chapters, **Getting Started** and **Basic Camera Operation**. Once you are familiar with basic operations, you may want to proceed to the chapter, **Advanced Camera Operation**.

- When you are reading through this manual, please remember that buttons and settings on the camcorder are shown in capital letters:  
e.g. Set the POWER switch to CAMERA.
- Use "Identifying the Parts" as an index to look for a function and operation according to the indication printed on the camcorder itself.

### Note on TV Color Systems

TV color systems are different depending on the countries. If you want to view the playback picture on a TV, you need an NTSC system based TV or a PAL-M system based TV with NTSC/PAL-M transcoder (as this is an NTSC system based camcorder). Please check the list on page 42 to see the TV color system of your country.

### Note on the Supplied RFU adaptor





You can use the supplied RFU adaptor only in the country where you bought this camcorder. Since each country has its own electricity and TV color system, you may not be able to use the RFU adaptor when you use the camcorder abroad.

### Note on Copyright

Television programs, films, video tapes, and other materials may be copyrighted. Unauthorized recording of such materials may be contrary to the provision of the copyright laws.

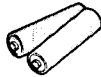
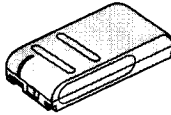
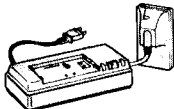
# Checking Supplied Accessories

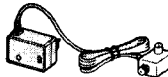
Check that the following accessories are supplied with your camcorder.

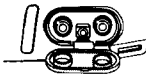
<ul style="list-style-type: none"><li>• Wireless Remote Commander (1)</li></ul> 	<ul style="list-style-type: none"><li>• Size AA (R6) battery for Remote Commander (2)</li></ul> 	<ul style="list-style-type: none"><li>• Battery pack NP-55 (1)</li></ul> 
<ul style="list-style-type: none"><li>• AC power adaptor AC-V35/V35A (1)</li></ul> 	<ul style="list-style-type: none"><li>• Lithium battery CR2025 (1) Change to plus side illus</li></ul> 	<ul style="list-style-type: none"><li>• RFU adaptor RFU-90UC (1)</li></ul> 
<ul style="list-style-type: none"><li>• Shoulder strap (1)</li></ul> 	<ul style="list-style-type: none"><li>• Lens cap (1) (attached to the camcorder)</li></ul> 	<ul style="list-style-type: none"><li>• Jack cover (1) (attached to the camcorder)</li></ul> 

## Before You Start

Before you can use your camcorder, you need to:

- 1 Charge and install the battery pack.
- 2 Insert a tape.
- 3 Adjust the viewfinder lens to your eyes.
- 4 Install the lithium battery.
- 5 Set the date and time.

This chapter takes you through these procedures step by step.

### You also need to set the BEEP switch

- The BEEP switch is preset to ON: the camcorder will beep when you start and stop recording and as a warning of unusual conditions (see page 50). These beeps will not be recorded on the tape.
- Set the BEEP switch to OFF, to deactivate the beep.

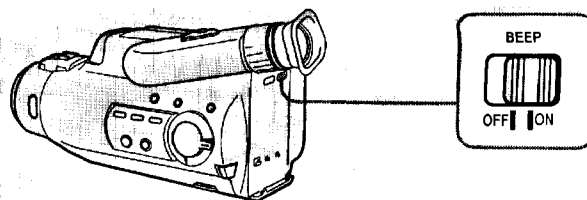

## Charging and Installing the Battery Pack

Before you can use this camcorder, you need to charge and install the battery pack

### Charging the Battery Pack

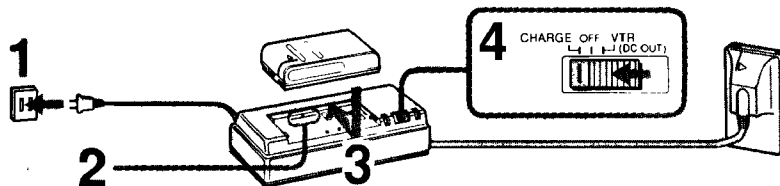

- 1 Plug the AC power adaptor into a wall outlet.
- 2 Align the flat side of the battery pack with the line on the AC power adaptor.
- 3 Push down and slide the battery pack in the direction of the arrow
- 4 Set the CHARGE/VTR switch to CHARGE.

Required charging time:

Type of battery pack	NP-55 (supplied)	NP-77H/ NP-77HD	NP-77	NP-66H	NP-55H
Required charging time	60	140	120	100	70

(approx. minutes using AC-V35/V35A)

When charging is finished, the charge indicator will go out.

### Important!

#### Use the battery completely before recharging!

Before you recharge the battery, make sure the battery has been used (discharged) completely. Excessive charging may reduce the charging capacity of the battery.

To use up the battery, remove the video cassette and set the POWER switch to CAMERA with the battery attached, and leave the camcorder until the  indicator appears blinking and a red lamp blinks in the viewfinder.

#### Option

AC-S10 AC power adaptor.

This adaptor has a function which allows you to confirm that the battery is completely discharged and ready to be recharged to its full capacity.

### Installing the Battery Pack

When you have finished charging the battery, install the battery pack as follows.

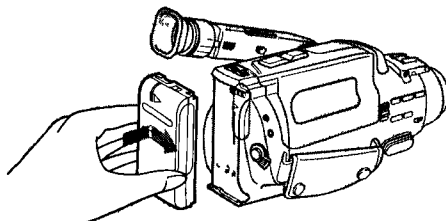

- 1 Align the flat side of the battery pack with the white line on the camcorder.
- 2 Make sure that the arrow on the battery pack is close to the top of the camcorder.
- 3 Push down and slide the battery pack in the direction of the arrow.

**Notes**

- Make sure the battery is securely installed so that it does not fall off. If the battery is not installed properly, the camcorder will not record accurately.
- You can use the AC power adaptor as a power source when recording indoors.

**Removing the battery pack**

Slide the BATT switch in the direction of the arrow, and at the same time, slide out the battery pack to the left.

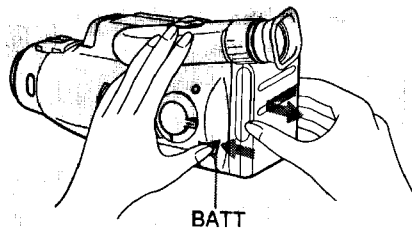

**Battery life and remaining capacity**

A fully charged battery pack lasts for:

Type of battery pack	NP-55 (supplied)	NP-77H/ NP-77HD	NP-77	NP-66H	NP-55H
Battery life	60	150	120	110	75

(approx. minutes, continuous recording when used indoors)

To check the remaining battery capacity, set the POWER switch to CAMERA, set the STANDBY switch up and press TAPE/BATT CHECK.

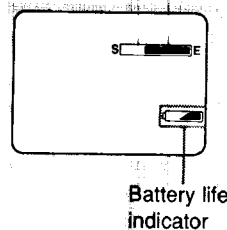
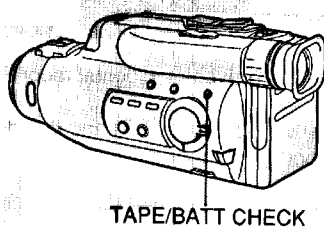

The decreasing black bar indicates decreasing battery power. After the black bar disappears the  indicator will appear and blink and a red lamp will also blink in the viewfinder. When they blink rapidly, replace the battery pack.

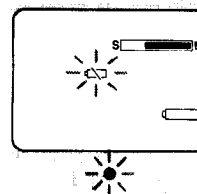

**Notes**

- The battery life indicator of the camcorder may indicate a different remaining capacity from that of the NP-77HD battery pack.
- Charge the battery pack when the black bar of the battery life indicator decreases quickly.

## Inserting a Tape

Make sure that the battery pack or another power source is attached.

- 1** Press the small blue button on the EJECT switch and simultaneously slide EJECT in the direction of the arrow. The cassette compartment automatically lifts up and opens toward you.

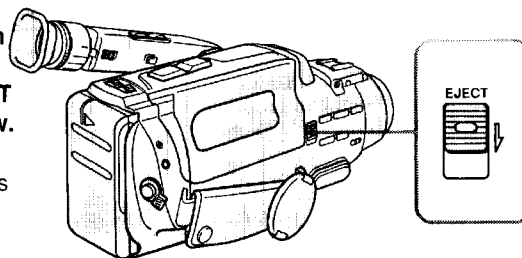

- 2** Insert a tape with the window facing outside.

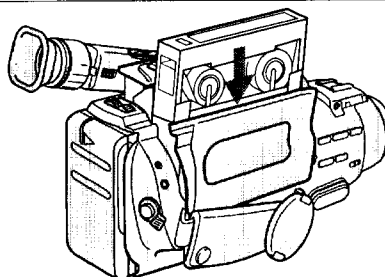

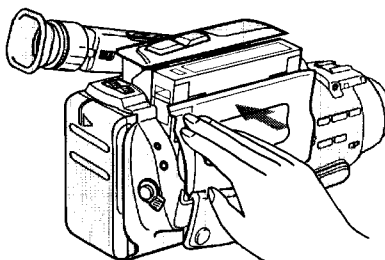

- 3** Close the cassette holder by pressing the area on the cassette compartment marked "PUSH".



## Preventing Accidental Erasure

Slide the red tab closing the window to prevent accidental recording. To re-record on the tape, slide the tab opening the window.

If you try to record with the red mark exposed, the  and  indicators flash in the viewfinder and beeps sound for about 5 seconds.

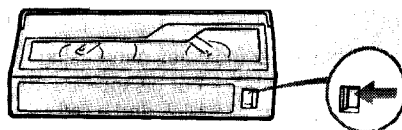

### Notes on handling tapes

Don't insert anything in the small holes on the rear of the cassette. These holes are used to sense the type and thickness of tape, or if the red mark is exposed or covered, etc. Store tapes in their cases and keep them in an upright position to prevent intrusion of dust and uneven winding.



# Adjusting the Viewfinder Lens

Before using your camcorder for the first time or after another person used it, adjust the viewfinder lens to best fit your eyesight. Make sure that a battery pack or another power source is attached to the camcorder.

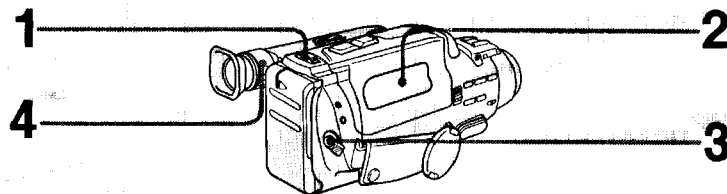

- 1** Press the small green button on **POWER** and set the **POWER** switch to **CAMERA**.



- 2** Insert a tape.  
(See page 8.)

- 3** Set the **STANDBY** switch up.



- 4** Turn the viewfinder adjustment ring around the viewfinder lens until the "STBY" indicator displayed in the viewfinder screen comes into sharp focus.

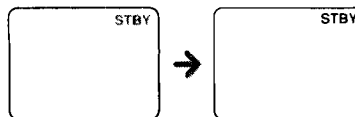

Inserting a Tape/  
Adjusting the Viewfinder Lens

## Using the viewfinder as a sports finder

Your camcorder is equipped with a Sports Finder. You can use the viewfinder as the sports finder by turning the viewfinder adjustment ring.

### What is a sports finder?

Since this finder has a long focal length, you can monitor the picture while your eye is at a distance from the eyecup. The sports finder is convenient when moving around to shoot scenes.

### Setting the viewfinder to the sports finder position

Turn the viewfinder adjustment ring clockwise completely.

### Returning from the sports finder position to the normal viewfinder position

Turn the adjustment ring counterclockwise until the word "STBY" that appears in the viewfinder comes into sharp focus.

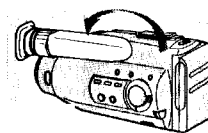
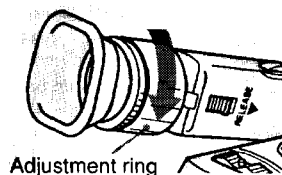

### When storing your camcorder

Turn the viewfinder barrel to the front.

# Installing the Lithium Battery

To keep birth dates in the camcorder's memory and to activate the clock, the lithium battery must be installed.

- 1** Remove the lithium battery holder located at the bottom of the camcorder.

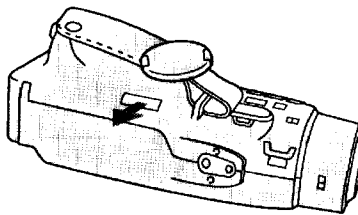

- 2** Install the supplied CR2025 lithium battery with the + side facing down.

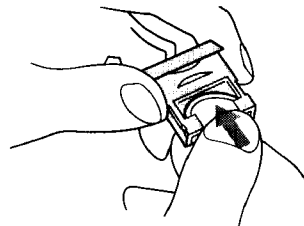
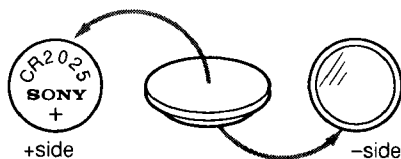

- 3** Put the lithium battery holder into the camcorder.

## Lithium battery life

The battery will last for approximately 1 year in normal operation. When the lithium battery becomes weak, the  indicator will blink in the viewfinder screen for about 5 seconds when you set the POWER switch to CAMERA. In this case, **replace the battery with a Sony CR2025 or Duracell DL-2025. Use of any other battery may present a risk of fire or explosion.**

When replacing the lithium battery, keep the battery pack or other power source attached. Otherwise, resetting the date, time and birth dates will be necessary.

## Changing the lithium battery

Remove the lithium battery holder from the camcorder, and pull out the lithium battery and insert a new one.

**WARNING** Battery may explode if mistreated.  
Do not recharge, disassemble, or dispose of in fire.

**Cautions**

- Keep the lithium battery out of the reach of children.  
Should the battery be swallowed, immediately consult a doctor.
- Do not hold the battery with metallic tweezers, otherwise a short-circuit may occur.

# Setting the Date and Time

You need to set your camcorder's date and time to be able to superimpose the date and time onto your video.  
Make sure that the power source and lithium battery are attached.

Installing the Lithium Battery/  
Setting the Date and Time

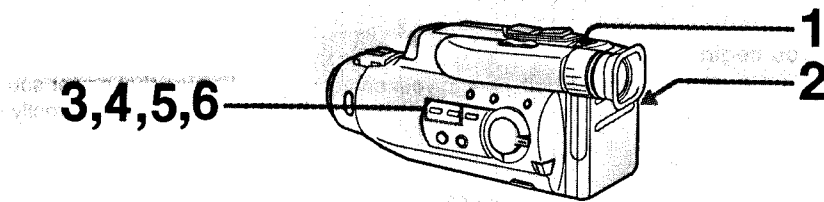

<p><b>1</b> Press the small green button on the POWER switch and slide the POWER switch to CAMERA.</p>	
<p><b>2</b> Set the STANDBY switch up.</p>	
<p><b>3</b> Press DATE (+) and TIME (NEXT) simultaneously for a few seconds until the date indicator appears in the viewfinder. The DATE button now functions as + (to advance numbers) and the TIME button functions as NEXT (to set).</p>	
<p><b>4</b> Adjust the blinking digits of the year, month, day, and hour by using DATE (+), and by pressing TIME (NEXT).</p> <p><b>Notes</b></p> <ul style="list-style-type: none"> <li>• When you keep DATE (+) pressed, the digits advance faster.</li> <li>• The year starts at 1992 and proceeds as follows: 1992--&gt;1999-&gt;2000--&gt;2020</li> </ul>	
<p><b>5</b> Adjust the blinking digits of minute by pressing DATE (+).</p>	
<p><b>6</b> Press TIME (NEXT) to set the second to "00". The clock starts operating.</p>	

**Correcting the date and time settings**  
Repeat steps 3 to 6.

# Storing a Birth Date In Your Camcorder

When you preset your child's birth date in your camcorder, you can put your child's age in years and months on your tape. You can also preset the date of an event. Once you enter the birth date of your child, the clock inside your camcorder will automatically update age of your child. You can superimpose the age anytime on your recording. You can preset up to three birth dates or events.

## Before you begin

Before you store a birth date in your camcorder, make sure that power source is connected, that the lithium battery is installed and that the date is correctly set.

## How to store birth date

To store a birth date in your camcorder, see the following example and procedure.  
Example: Store "Aug. 3, 1987" in memory 2.

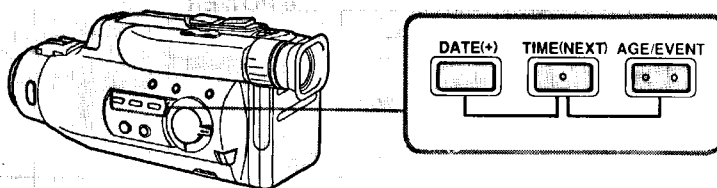

<p><b>1</b> Press the small green button on the <b>POWER</b> switch and slide the <b>POWER</b> switch to <b>CAMERA</b>.</p>	
<p><b>2</b> Set the <b>STANDBY</b> switch up.</p>	
<p><b>3</b> Press <b>TIME (NEXT)</b> and <b>AGE/EVENT</b> simultaneously for a few seconds until the "<b>1</b> BIRTHDAY--- --1900" indicator appears in the viewfinder.</p>	
<p><b>4</b> Press <b>DATE (+)</b> to select <b>2</b>. Each time you press <b>DATE (+)</b>, the display in the viewfinder changes as follows:</p> <p><b>1</b> BIRTHDAY → <b>2</b> BIRTHDAY ← <b>3</b> EVENT* ←</p> <p>* Although "EVENT" is displayed on <b>3</b>, you can use it for age as well. <b>1</b> and <b>2</b> can also be used to record event dates in memory.</p>	
<p><b>5</b> Press <b>TIME (NEXT)</b>. The "1900" indicator blinks.</p>	

(continued)

**6 Enter the birth date.**  
 First adjust the blinking digits by pressing DATE (+), and then press TIME (NEXT).  
 The age (year and month) appears when all the items are adjusted.

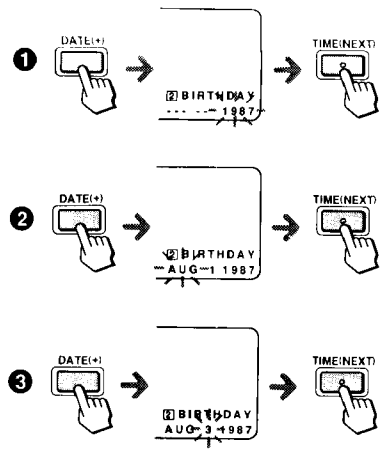

**If you missed the correct number with DATE (+)**

Keep pressing DATE (+).  
 The indicator changes as follows:

Year: 1900 → 1901 --- → Current year  
 ↑  
 Current year - (minus) 99 ←

Month: JAN. → FEB. --- → DEC. → ---  
 ↑

Day: 1 → 2 --- → 31  
 ↑

**Correcting/changing the setting**

Follow the procedures from step 1 again.

**Advancing the digits faster**

Keep DATE (+) pressed.

**Presetting the year before 1900**

- 1 After step 5 on page 12, keep pressing DATE (+) until the current year is displayed.
- 2 Press DATE (+) again.  
 The year goes back 99 years.  
 (example: 1992 → 1893)
- 3 Go to step 6 above.

**When in 2000**

"--- --1901" is displayed in step 3 on page 12. After that, it advances every year as "1902, 1903, ....".

**Now it's ready for recording!**

## Chapter 2: Basic Camera Operation

# How to Record

Before you record one-time events, make a trial recording to make sure that your camcorder is working properly.

Keep the lens clean, or the focus cannot be adjusted properly.

It is very easy to start recording scenes.

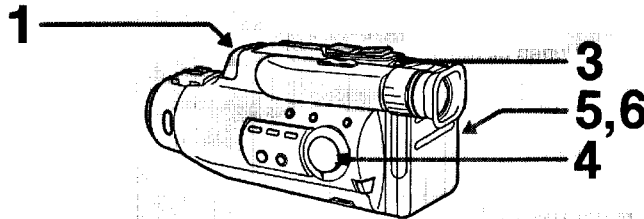

- 1** Hold the camcorder by putting your hand through the grip belt so that your thumb can easily press the red START/STOP button.

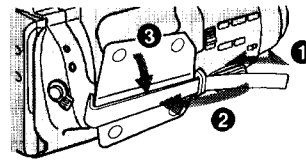

- 2** By pressing the release on the lens cap, remove and attach it to the grip belt.

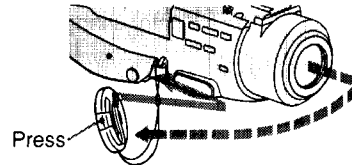

- 3** Press the small green button on the POWER switch and slide the POWER switch to CAMERA.
- This puts the camcorder in the camera recording mode.



- 4** Set the PROGRAM AE (Auto Exposure) switch to the green position.

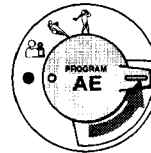

- 5** Set the STANDBY switch up.
- "STBY" appears in the viewfinder. Now, you can see through the viewfinder.

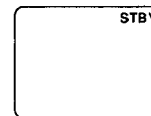

- 6** Press START/STOP (red button) once.
- The camera is recording when the word "REC" appears on the viewfinder screen and the red lamp lights in the viewfinder. You can also confirm the start of recording with beep sound when you have the BEEP switch turned on.

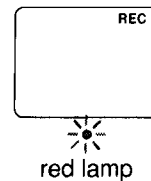

In the viewfinder you can see a black and white picture of what you are recording and information that indicates what the camcorder is now doing.

### Automatic recording

With the PROGRAM AE switch set to the green position, all the camera functions are on automatic (i.e. auto iris, auto white balance, auto focus) and the shutter speed is set at normal (1/60 second).

### To stop recording momentarily

Press START/STOP again. "STBY" appears in the viewfinder. The camcorder beeps twice when you have BEEP turned on.

### When you have finished recording

Turn the STANDBY switch down and slide the POWER switch to OFF.

### Ejecting the tape

Make sure that you have attached the battery pack or other power source to the camcorder.

- 1 Press the small blue button on the EJECT switch, and at the same time push EJECT in the direction of the arrow.
- 2 Take out the tape.
- 3 Close the cassette holder by pressing the area marked PUSH on the cassette compartment.

#### Caution!

Please remember that you can only use 8-mm format video tapes with this camcorder. You will be able to record tapes in SP (standard play) mode only and play back tapes in both SP and LP (long play) modes.

### Checking the time remaining on the tape

Press TAPE/BATT CHECK.

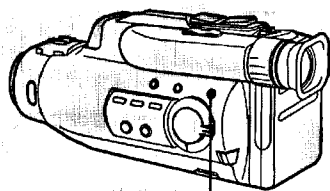

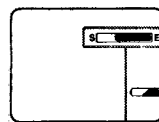

TAPE/BATT CHECK

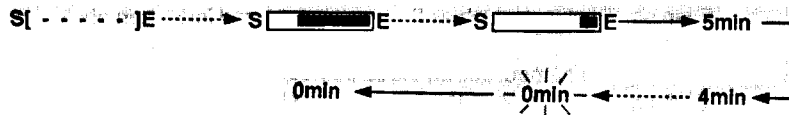

Tape length indicator

After pressing TAPE/BATT CHECK, the time remaining may not be indicated for about 20 seconds. When the time remaining is less than about 5 minutes, the indicator displays the minutes remaining.



When "5 min" lights, the  indicator appears in the viewfinder and blinks.

#### Note on the tape length indicator

- The camcorder must be in the recording or playback mode when the TAPE/BATT CHECK is pressed to find out the time remaining. In the playback mode, however, the indicator does not indicate the minutes remaining.
- The tape length indicator does not change while using EDITSEARCH.

# Using Zooming Features

You can create a professional-looking home video using these special effects; zoom, close-up, fade-in and fade-out.

## Zooming

Zooming is a recording technique that lets you change the size of the subject in the scene. Use "Zoom-in (telephoto)" for dramatic close-ups, and "zoom-out (wide-angle)" for panoramic long shots. You can also use zooming to focus manually or to decide on a shooting angle. For more professional-looking recordings, use zooming sparingly.

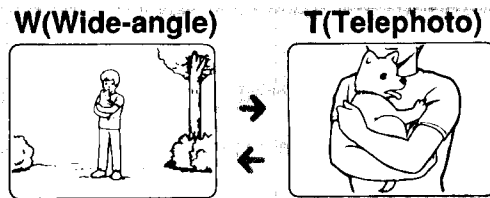

To zoom

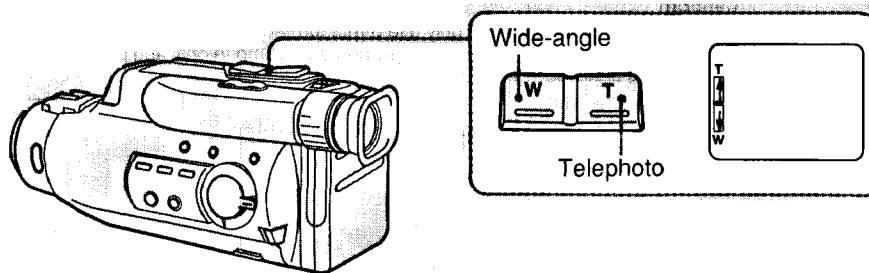

## Two-level Speed Zooming

The camcorder's power zoom button offers two-level speed zooming. Press it firmly for high speed zooming and softly, for relatively slow zooming. Press the T side of the power zoom button for telephoto (subject appears closer) and the W side for wide-angle (subject appears farther away).

## Focusing in Macro

Even small subjects such as flowers, insects, and images in photographs, can literally fill the screen using focus in macro.

- 1 Bring the camcorder as close as necessary to obtain the desired subject size.
- 2 Press the W side of the power zoom button until the indicator in the viewfinder stops at the W end.

**Note** You can shoot a subject that is at least 1 m (about 39<sup>3</sup>/<sub>8</sub> inches) away from lens surface in the telephoto position.



## Playing Back a Tape

You can use this camcorder as a VCR by connecting it directly to your TV for playback. After you connect this camcorder to your TV, use the Remote Commander for convenient control of the camcorder.

### If Your TV Has Only an Antenna Input

Use the supplied RFU adaptor to connect your camcorder to your TV. Before connecting, make sure that the TV is turned off to prevent speaker damage. **If your TV has audio/video inputs, see page 33.**

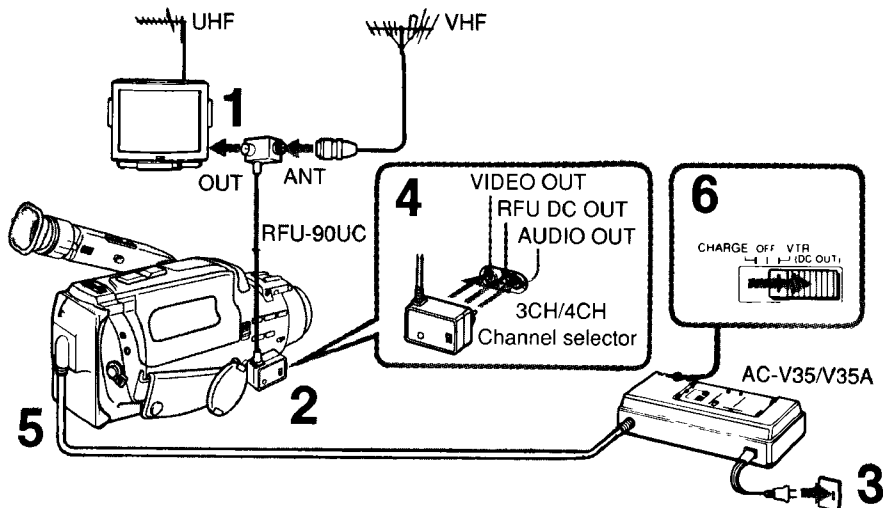

To connect your camcorder to a TV that is already connected to a regular TV (VHF) antenna, you need to:

- 1 Unplug the antenna cable from your TV first.  
Plug in the tail end of the RFU adaptor marked OUT to the antenna input of your TV. Re-wire the antenna cable you unplugged to the RFU adaptor jack marked ANT. This way, you can switch between TV broadcasting and your home video playback without re-wiring.
- 2 Connect the RFU adaptor to the camcorder.
- 3 Connect the AC power adaptor to a wall outlet.
- 4 Set the channel selector on the RFU adaptor (and your TV channel) to 3 CH or 4 CH of the VHF channel, whichever is not active (vacant) in your area.
- 5 Attach the connecting plate of the AC power adaptor to the camcorder.
- 6 Make sure the CHARGE/VTR selector on the AC power adaptor is set to VTR position.

#### Note

When you want to switch to a regular TV program, set the CHARGE/VTR selector to OFF or turn off the power on the camcorder

## Playing Back a Tape

### How to Play Back a Tape

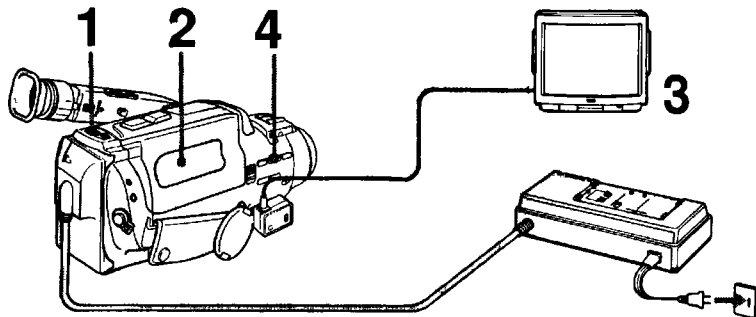

- 1** Press the small green button on the POWER switch and set the POWER switch to **PLAYER**.



- 2** Insert a tape. (See page 8.)

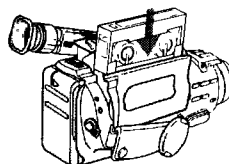

- 3** Turn on the TV and select the channel to which you adjusted the RFU adaptor (3 CH or 4 CH).  
If you are connecting with audio/video inputs, set your TV's TV/VIDEO selector to VIDEO

- 4** Press **▷ (PLAY)**.

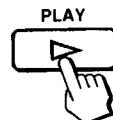



To stop playback, press **□ (STOP)**.  
To rewind the tape, press **◀◀ (REW)**.  
To advance the tape rapidly, press **▶▶ (FF)**.

#### When you have finished playback

- 1 Eject the tape, see page 15
- 2 Slide the POWER switch to OFF.
- 3 Set the CHARGE/VTR switch on the AC power adaptor to OFF.

# Using the Remote Commander

By using the Remote Commander, you can be in the picture with your friends and family, or conveniently control the playback of your tape from a distance.

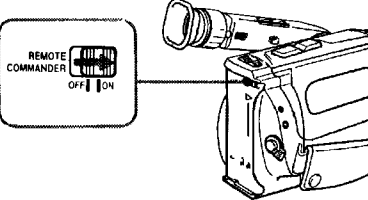
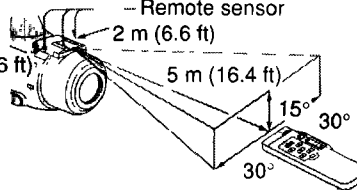
<p><b>1</b> Insert two size AA (R6) batteries with the + and – ends properly positioned.</p>	
<p><b>2</b> Set the  REMOTE COMMANDER switch on the battery mounting surface of the camcorder.</p> <p>If the battery is attached, remove it. Reattach the battery after setting the REMOTE COMMANDER ON/OFF switch.</p>	
<p><b>3</b> Set the POWER switch on the camcorder as follows:</p> <ul style="list-style-type: none"> <li>— When camerarecording, 1) press the small green button on the POWER switch and slide it to CAMERA, 2) set the STANDBY switch up.</li> <li>— When playing back, slide the POWER switch to PLAYER.</li> </ul>	
<p><b>4</b> Aim the Commander at the remote sensor on the camcorder and press the appropriate button on the Commander.</p>	 <p>(Approximate maximum distance and angles for remote control)</p>

Playing Back a Tape/  
Using the Remote Commander

## Note on the Remote Commander

- Keep the remote sensor away from strong light sources such as direct sunlight or illumination. Remote control with the Commander may not function properly under such circumstances.
- The command mode of the Commander is VTR2. Avoid using the Sony VCRs with the same command mode at the same time.

## Getting familiar with some buttons

### HOLD switch

When you slide the switch in the direction of the arrow, all the buttons will become inoperable to prevent any misoperation should you accidentally press the buttons.

### ▶ SLOW and DATA SCREEN buttons

You can use the functions of these buttons only with the Commander.

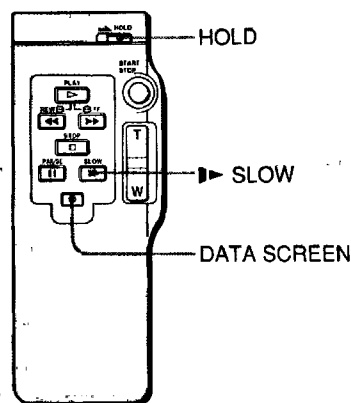

**Battery life** In normal operation, batteries last up to six months. If the camcorder does not operate properly, the batteries might be exhausted. Replace both batteries with new ones.

## To avoid damage from possible battery leakage

Remove the batteries when you will not use the Commander for a long time.

## When you connect the receiver of a remote control kit

When you connect the receiver of a remote control kit (not supplied) to the REMOTE control connector, be sure to set the  REMOTE COMMANDER switch on the battery mounting surface of the camcorder to OFF.

# Getting the Most out of Your Battery Pack

## How to Prepare the Rechargeable Battery Pack

Have sufficient battery pack power to do 2 or 3 times as much recording than you have planned.

"Battery life" indicated in this manual is measured by the continuous recording time of the camcorder, placed at room temperature using a fully-charged battery

**Battery life is shorter in cold climates.**

Battery efficiency is decreased and the battery will be used up more quickly

**Set the STANDBY switch of the camcorder down when not recording to save battery power.**

A smooth transition between scenes can be made even if recording is stopped and started again. While positioning the subject or selecting an angle, or looking through the viewfinder lens, the lens moves automatically inside the camcorder and the battery is used. The battery is also used when a tape is inserted or removed.

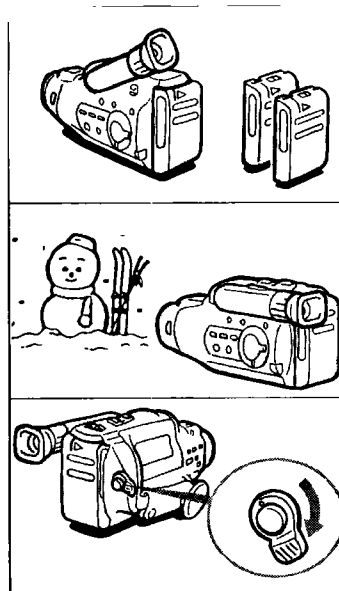

## When the Rechargeable Battery Pack Should Be Replaced

When the  $\square$  indicator and red lamp in the viewfinder change from slow blinking to rapid blinking while you are recording.

Turn off the power switch of the camcorder and replace the battery pack

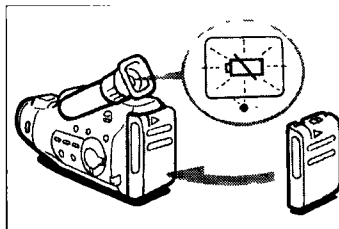

## Notes on Charging

**Before using the battery pack, charge it sufficiently.**

A brand new battery pack is not charged

**Make sure you use up the battery before recharging.**

- If recording is completed before the  $\square$  indicator appears in the viewfinder, it is recommended that you remove the tape, set the POWER switch to CAMERA, turn the STANDBY switch up, and leave the camcorder on until the  $\square$  indicator blinks rapidly
- When you use the AC-S10 AC power adaptor, the DC-S10 car battery charger or BC-S10 portable battery charger, you can discharge the battery with their discharging function
- **Repeated charging without using up the battery may cause lowering of battery capacity. However, the original battery capacity can be recovered if you fully discharge (use up) and charge the battery again.**

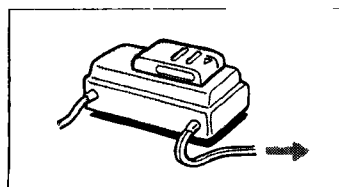

**Recharge the battery pack after long storage.**

If the battery pack is fully charged but not used for a long time (about 1 year), it becomes discharged. Charge it again but in this case the battery life will be shorter than normal. After several charging and discharging cycles, the battery life will recover its original capacity

### Keep the Terminals Clean

If the terminals (metal parts on the back) are not clean, the battery duration will be shortened.

When the terminals are not clean or when the battery pack has not been used for a long time, install and remove the battery pack from time to time. This will improve the contact condition. Also, wipe the + and - terminals with a soft cloth or paper.

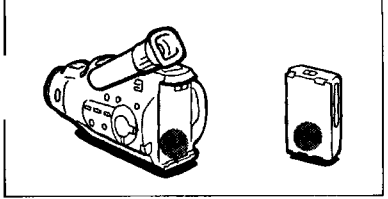

### Notes on the Rechargeable Battery Pack

#### Why the battery pack heats up?

During charging or recording, the battery pack heats up. This means energy has been generated and chemical change has occurred inside the battery pack, and this is not dangerous

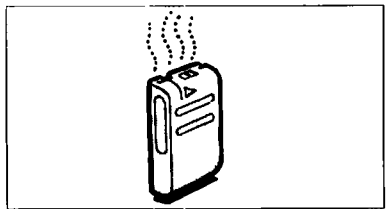

#### How to care for the battery pack

- Remove the battery pack from the camcorder after using it, and keep it in a cool place. When the battery pack is in the camcorder, a small amount of current flows to the camcorder even if it's turned off. This gradual discharge shortens battery life.
- The battery pack is always discharging even when it is not in use after charging. Thus, it is recommended you charge the battery right before using.

#### How to use the switch on the battery pack

This switch is provided so that you can remember the charging condition. Set the switch to the "no mark" position when charging is completed. Set the switch to the "red mark" position when the battery is used up.

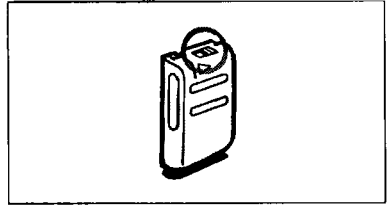

#### How many times can the battery pack be recharged?

The battery pack can be fully charged and discharged about 500 times under normal temperatures. If the  indicator blinks rapidly just after turning on the camcorder with a fully charged battery pack, the battery pack should be replaced with a new fully charged one.

#### Recommended temperatures during charging

Charging under temperatures ranging from 10°C to 30°C (5°F to 85°F) is recommended. Lower temperatures require a longer charging time.

## Chapter 3: Advanced Camera Operation

# Connecting Alternative Power Sources

You can choose any of the following power sources for your camcorder: battery pack (see page 6), house current, and 12/24 V car battery. The appropriate power source for you to choose depends on the place where you want to use your camcorder.

Place	Power source	Accessory to be used
Outdoors	Battery pack	Battery pack NP-55 (supplied), NP-77H/77HD, NP-77, NP-66H or NP-55H
Indoors	House current	AC power adaptor AC-V35/V35A (supplied), AC-V30 or AC-S10
In the car	12 V or 24 V car battery	DC pack DCP-77

### Note on power sources

Disconnecting the power source or removing the battery pack during recording or playback may damage the inserted tape. In this case, supply the power again immediately.

## Using House Current

The supplied AC-V35/V35A AC power adaptor is required.

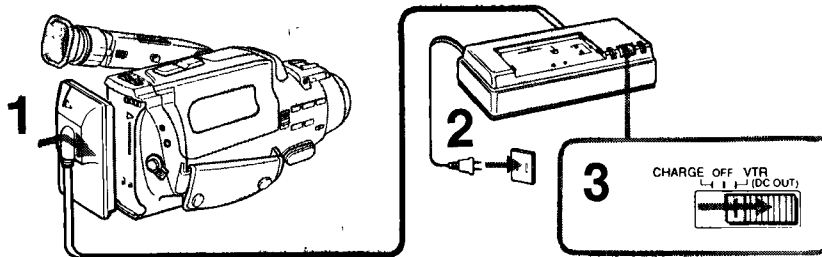

- 1** Align the flat side of the connecting plate with the white line on the camcorder, and push down and slide it in the direction of the arrow.
- 2** Connect the AC power adaptor to a wall outlet.
- 3** Set the CHARGE/VTR selector of the AC power adaptor to VTR.

See the instruction manual of the AC power adaptor for details.

### To remove the connecting plate

Remove it in the same way as you do with the battery pack. See page 7.

## Using Car Battery

The DCP-77 DC pack (not supplied) is required.

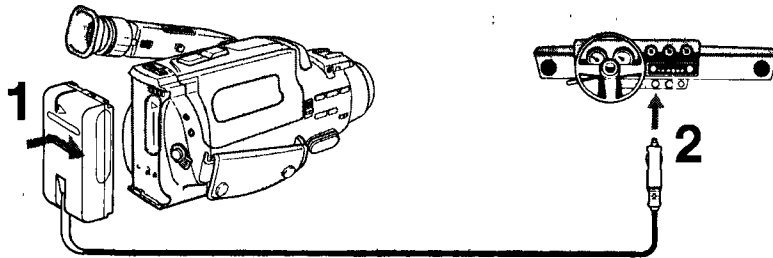

- 1** Align the flat side of the DC pack with the white line on the camcorder, and push down and slide it in the direction of the arrow.
- 2** Connect the cord of the DC pack to the cigarette lighter socket of a car (12 V or 24 V).

### To remove the DC pack

Remove it the same way as you do with the battery pack. See page 7.

### Options

- BC-77, BC-S10 portable battery charger  
You can charge a battery pack on 100 – 240 V AC. BC-S10 has a discharging function, so you can charge a battery pack whether or not it is used up
- DC-S10 car battery charger with discharging function:  
You can charge a battery pack through the cigarette lighter socket

# Camera Recording

In the previous chapter "Basic Camera Operation", you learned the basic recording operations. This section shows you how to record the date or time, record an age, re-record a picture and more.

## Recording the Date or Time

Date or time can be superimposed on your recording

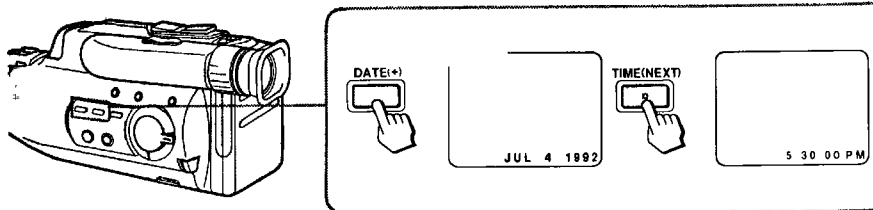

**During camera recording or when in standby mode, press DATE for date indication or TIME for time indication.**

The date or time displayed in the viewfinder is recorded with the picture.

### To stop recording date or time

Press DATE or TIME again.  
The picture recording continues.

## Putting an Age on Your Tape

Here's how to put the age of your children in your video while recording.

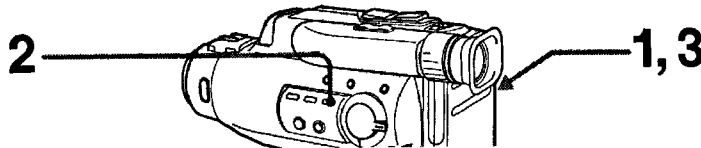

**1** During recording, press **START/STOP** at the point where you want to insert the age of a person or the elapsed time.

This puts the camcorder in the standby mode.



START / STOP

**2** Press **AGE/EVENT** to select the indicator you want to record.

Each time you press AGE/EVENT, the indicator changes as follows:

No indicator → **1** The first age

**3** The third age ← **2** The second age

An item with no presetting is skipped

The **1**, **2**, or **3** indicator goes out after one second.

AGE/EVENT



**3** Press **START/STOP**.

Recording starts again.

The indicator in the viewfinder is recorded with the picture



START / STOP



**Note**

You cannot add the age later during playing back or editing.

**To stop recording the age**

Press AGE/EVENT until the indicator goes out.

**To change the display while recording**

Press AGE/EVENT until the indicator you want to record is displayed. Recording of the indicator you select starts when [1], [2], or [3] goes out.

**To cancel the stored birth date**

- 1 Perform steps 1 to 4 in "Storing a Birth Date in Your Camcorder" on page 12, to select the memory number to be canceled.
- 2 Press TIME (NEXT) twice. The month indicator blinks.
- 3 Press DATE (+) until "-- --" appears.
- 4 Press TIME (NEXT).

The birth date is deleted from the memory and is not displayed when you press AGE/EVENT.

**About memory back-up**

The camcorder uses the lithium battery on the bottom to keep the birth date in memory. The lithium battery life is approximately 1 year

**When you connect the camcorder to a TV during recording**

If you do not use the data-screen function by the Remote Commander, the age indicator will appear on the TV screen when the [1], [2], or [3] indicator goes out in the viewfinder and recording starts.

**For Low-position Recording**

You can also record from low position to get an interesting recording angle.

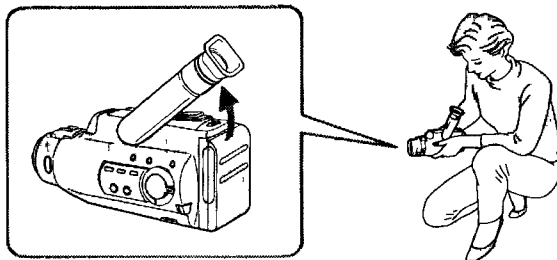

Set the viewfinder to the sports finder position (page 9) and turn it for the low position recording. (It can be turned 180 degrees.)

## Camera Recording

### Checking the Last Portion of a Scene You Just Recorded (Rec Review)

You can check the last portion of a scene you just recorded without changing the setting of the POWER switch using EDITSEARCH.

- 1 Put the camcorder in the standby mode by pressing the START/STOP button.



- 2 Press the - (⏮) side of EDITSEARCH momentarily.

The last few seconds of the recorded portion will be played back in the viewfinder. After a few seconds of playback, the camcorder goes back to the standby mode, ready for the next recording.



#### Note on using EDITSEARCH

When you raise the viewfinder and use EDITSEARCH, hold the viewfinder with your thumb to prevent movement.

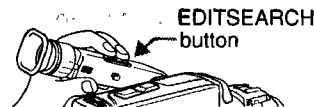

### Checking Recording in the Viewfinder (EDITSEARCH)

You can check the recorded picture in the viewfinder using EDITSEARCH. Sound cannot be monitored.

- 1 Press the small green button, and slide the POWER switch to CAMERA.



- 2 Set the STANDBY switch up.



- 3 Keep pressing the + or - side of EDITSEARCH to view the playback picture:

+ side for the playback picture  
- side for the playback picture in reverse.



#### To stop playback



Release EDITSEARCH.

#### To monitor the sound while viewing the playback picture in the viewfinder

- 1 Connect an earphone to the Ⓜ (earphone) jack.
- 2 Press the small green button and slide the POWER switch to PLAYER.
- 3 Press ◀◀ to rewind the tape and press □ where you want to stop.
- 4 Press ▶▶ to start playback.

## Re-recording on a Previously Recorded Portion (EDITSEARCH)

You can reshoot a scene over the last recorded portion using EDITSEARCH. The previously recorded portion will be erased.

<b>1</b> Set the <b>STANDBY</b> switch up.	 START / STOP
<b>2</b> Look in the viewfinder and find the point from where you want to begin recording by: Keep pressing the + side of EDITSEARCH continuously to advance the picture at a normal playback speed, or the - side to reverse the picture.	 + EDITSEARCH - G
<b>3</b> At the desired point, release EDITSEARCH.	
<b>4</b> Press <b>START/STOP</b> . Recording begins from the point you released EDITSEARCH. A smooth transition between scenes can be made after the pre-recorded portion even if STANDBY is turned down and turned up, or even if the power is turned off and on again, provided that the tape is not removed.	 START / STOP

### To pause recording

Press START/STOP again.

### To stop recording

Set the STANDBY switch down.

## Helpful Hints for Recording

### If the tape reaches near the end during recording

The  indicator and the red lamp in the viewfinder and the camera recording/battery lamp on the camcorder blink slowly. When the tape reaches its end, blinking becomes rapid and beeps sound for about five seconds (if BEEP is set to ON).

### Notes on recording

- To record from the beginning of the tape, run the beginning of the tape for about 15 seconds before recording. This will avoid missing the starting point when the tape is played back.
- When moving from indoors to outdoors, or vice versa, turn STANDBY up and point the camcorder at a white object for about 10 seconds so that the white balance is properly adjusted.

### Note on standby mode

If you leave the camcorder in the standby mode for 5 minutes or more, the camcorder will be automatically turned off. To resume the standby mode, turn STANDBY down and turn it up again. To start recording, press START/STOP directly.







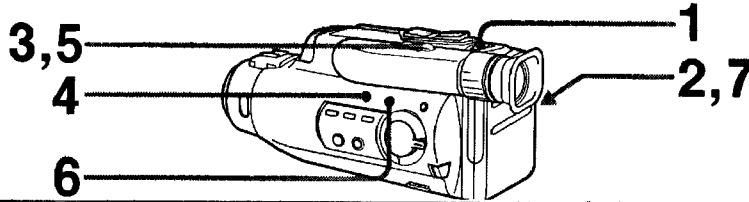

### Note on light sources

If you are shooting a subject in bright conditions just after shooting in a dark place, the picture may not appear in the viewfinder. In this case, point the camcorder in the other direction.

## Inserting a Scene in the Middle of a Recorded Tape

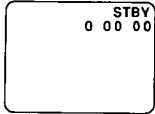
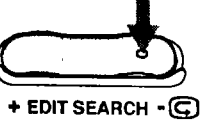
You can insert a scene in the middle of a recorded tape by setting the starting point and ending point. A previously recorded portion will be erased.

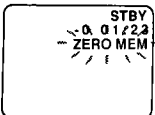

<p><b>1</b> Press the small green button and slide the POWER switch to CAMERA.</p>	 <p>GAMERA/OFF PLAYER POWER</p>
<p><b>2</b> Set the STANDBY switch up.</p>	 <p>LOCK STANDBY START / STOP</p>
<p><b>3</b> While looking in the viewfinder, keep pressing the + or - side of EDITSEARCH and release the button where you want to end the insertion. The camcorder enters the standby mode again.</p>	 <p>+ EDITSEARCH -</p>
<p><b>4</b> Press COUNTER RESET. The counter is reset to zero.</p>	 <p>COUNTER RESET</p>  <p>STBY 0 00 00</p>
<p><b>5</b> While looking in the viewfinder, keep pressing the - side of EDITSEARCH and release the button at the point where you want to start the insertion.</p>	 <p>+ EDIT SEARCH -</p>
<p><b>6</b> Press ZERO MEM. The insert ending point is stored in memory.</p>	 <p>ZERO MEM</p>  <p>STBY 0 01/22 - ZERO MEM</p>
<p><b>7</b> Press START/STOP. Insert recording begins. The insert recording stops automatically at the counter zero point.</p>	 <p>LOCK STANDBY START / STOP</p>

### To cancel the ZERO MEM

Press ZERO MEM.

**Note** The picture may be distorted at the ending point when played back

## Recording with an External Microphone

You can connect an external microphone (not supplied) to the MIC jack. This jack also accepts a "plug-in-power" microphone.

Attach the microphone to the accessory shoe of the camcorder.

If the microphone has two plugs, connect the DC IN plug to the RFU DC OUT jack on the camcorder.

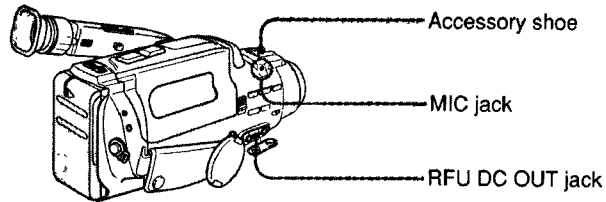



**Note** When recording with an external microphone, wind noise is not muted.

## Connecting a Wired Remote Control Unit

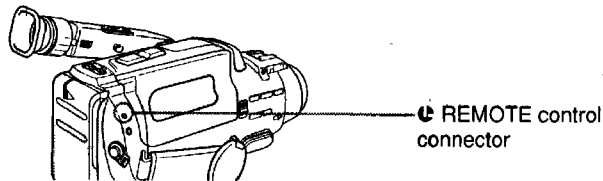
When you connect a wired remote control unit or editing controller (not supplied) to the  REMOTE control connector, you can operate your camcorder from a distance.



### About (LANC)

 stands for Local Application Control Bus System. The  connector is used for controlling the tape transport of video equipment and peripherals connected to it. This connector has the same function as the connectors indicated as CONTROL L or REMOTE.

## Manual Adjustments

The camcorder's automatic functions offer you worry-free operation under most shooting conditions. But in some circumstances, manual adjustment is better for effective recording. You can manually maintain focus and compensate for backlighting with this camcorder. Some shooting situations may call for using some items manually, while others may call for using them automatically.

The previous manual settings are retained, as long as you do not remove the battery, even if you set the POWER switch to OFF.

### Maintaining Focus

Your camcorder may automatically refocus on a subject other than the desired subject.

In such cases, use the PUSH FOCUS HOLD button or the FOCUS HOLD switch to keep the desired subject in focus.

Hold down the PUSH FOCUS HOLD button.

The focus is maintained and the  indicator is displayed while you hold down this button.

To maintain the focus without having to keep pressing the PUSH FOCUS HOLD button, use the FOCUS HOLD switch:

While pressing the PUSH FOCUS HOLD button, slide the FOCUS HOLD switch in the direction of the arrow. You may now release the PUSH FOCUS HOLD button. Your camera's focus is held and the  indicator appears in the viewfinder.

To resume automatic focus, slide the FOCUS HOLD switch in the opposite direction of the arrow.

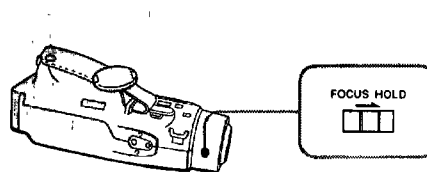
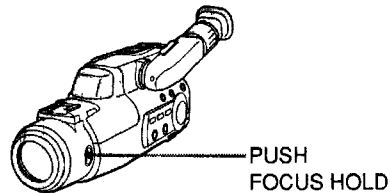

#### Note

When using a Sports Pack or Marine Pack, set the FOCUS HOLD switch in the direction of the arrow.

### Compensating for Backlighting

In this camcorder, the exposure is automatically controlled. However, when shooting a subject that is backlit, that is, if the light source is coming in from the back of the subject, use the BACK LIGHT button to get natural exposure.

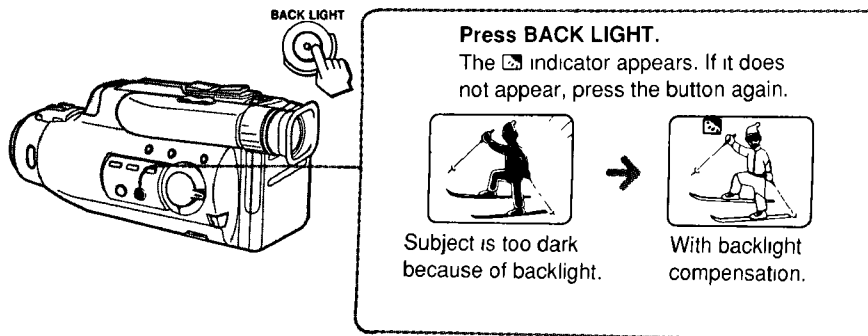

#### After shooting







Be sure to release this adjustment condition by pressing BACK LIGHT again. (The  indicator goes out.)

Otherwise, the picture will be too bright under normal lighting condition.

# Using Program AE (Auto Exposure)







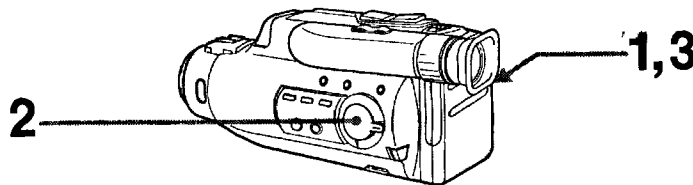

When you use the PROGRAM AE (Auto Exposure) function, you can give a portrait effect (the object is in focus and the background is out of focus) or capture high-speed action with "sports" mode or "high speed shutter" mode. Select from three types of mode referring to the following table.

## To choose best programmed AE mode

When shooting:	Select:
<ul style="list-style-type: none"> <li>• A still subject such as person or a flower</li> <li>• Zooming in a subject in the telephoto mode</li> <li>• A subject behind such obstacle as a net</li> </ul>	  <p>(Portrait mode)</p>
<ul style="list-style-type: none"> <li>• Outdoor sports scene such as football, tennis or golf</li> <li>• A landscape in a moving car</li> </ul>	  <p>(Sports mode)</p>
<ul style="list-style-type: none"> <li>• A golf swing or a tennis match with the tennis ball captured clearly</li> <li>• Playing back certain scenes with high speed movements in a clear, sharp picture</li> </ul>	  <p>(High speed shutter mode)</p>

## Selecting the PROGRAM AE Mode

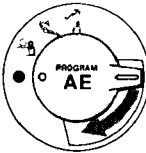

<p><b>1</b> Set the <b>STANDBY</b> switch up.</p>	
<p><b>2</b> Set the <b>PROGRAM AE</b> switch to , , or  to the desired setting. , , or  appears in the viewfinder</p>	
<p><b>3</b> Press <b>START/STOP</b>. Recording with the portrait, Sports, or high-speed shutter mode starts</p>	

Manual Adjustments/  
Using Program AE (Auto Exposure)

## To resume the automatic mode

Set the PROGRAM AE switch to the green position.

### Notes

- When recording under fluorescent, sodium, or mercury lamp, the brightness of the recorded picture may vary, or the color of the recorded picture may become unnatural.
- The shutter speed in each PROGRAM AE mode is as follows.  
Portrait mode – between 1/60 to 1/2000  
Sports mode – between 1/60 to 1/500  
High speed shutter mode – 1/4000

## Fade-In and Fade-Out

You can fade-in or fade-out to give your recording a professional appearance.

When fading-in, the picture will gradually appear from black.

The sound will also gradually increase.

When fading-out, the picture will gradually fade to black. The sound will also decrease.

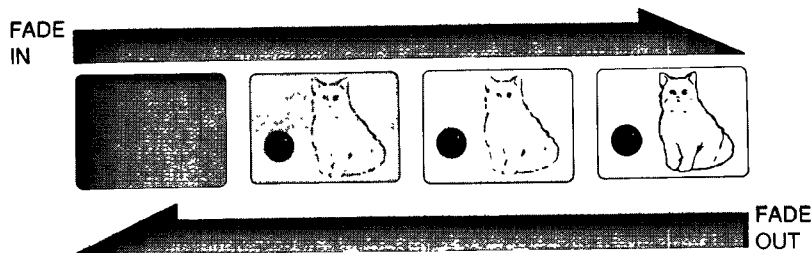

### When fading-in

- 1 Press FADER after setting the STANDBY switch up to put the camcorder into standby mode.**

The FADER indicator starts blinking.



- 2 Press START/STOP.**

The FADER indicator stops blinking and the recording starts fading in.



### When fading-out

- 1 Press FADER while recording.**

The FADER indicator starts blinking.

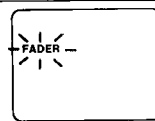

- 2 Press START/STOP.**

The FADER indicator stops blinking and the picture fades out and the recording stops.



### To cancel the fade-in/out function

Before pressing START/STOP, press FADER again.

### Using the fade-in/out function repeatedly

Start from step 1 each time.

### When the date/time (page 24), or age (page 24), is displayed

The date/time, or age does not fade-in or fade-out.



## Playing Back

In the earlier section (page 17) we explained the basic connection to your TV with the RFU adaptor. In this section we discuss several other ways of connecting to your TV.

### Connecting a TV with Audio/Video Inputs

There are several ways to connect your camcorder to your TV. If your TV has audio/video inputs, use an A/V cable. Before connecting, make sure that your TV is turned off to prevent speaker damage. **If your TV has only an antenna input, see page 17.**

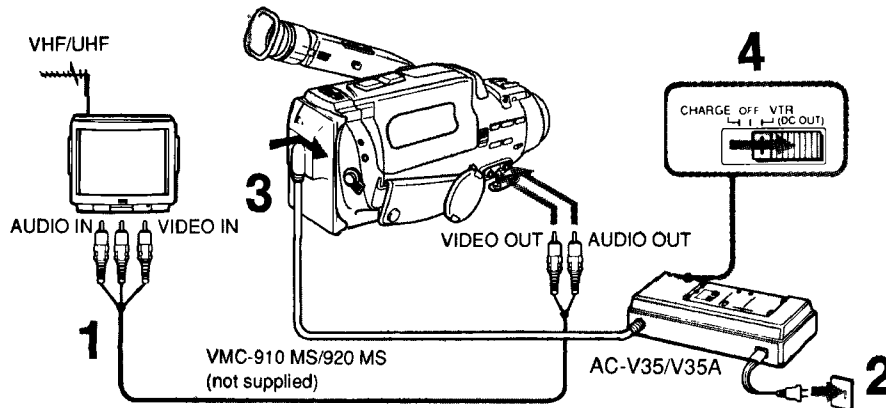

- 1 Use an A/V cable to connect your TV and camcorder:
  - [a] If your TV is a stereo type, use the VMC-910MS/920MS A/V connecting cable (not supplied).
  - [b] If your TV is a monoaural type, use the VMC-710M/720M A/V connecting cable (not supplied).
- 2 Connect the AC adaptor to a wall outlet.
- 3 Attach the connecting plate of the AC power adaptor to the camcorder.
- 4 Set the CHARGE/VTR selector on the AC power adaptor to VTR (DC OUT).

Playing Back

## Playing Back

### Connecting to a TV via a VCR

#### If your TV has no AUDIO/VIDEO input jacks

Disconnect the antenna connection between the TV and the VCR, and connect the RFU adaptor to the VHF/UHF input of the TV and VHF/UHF output of the VCR.

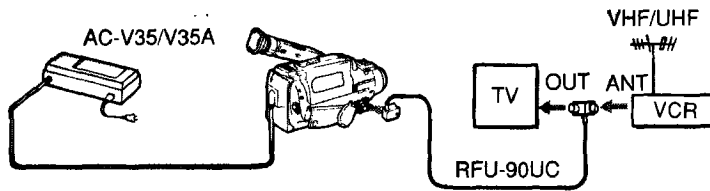

#### If your TV has AUDIO/VIDEO input jacks

Connect Audio and Video from the camcorder to the VCR instead of to the TV. Set the input selector of the VCR to LINE, if available.

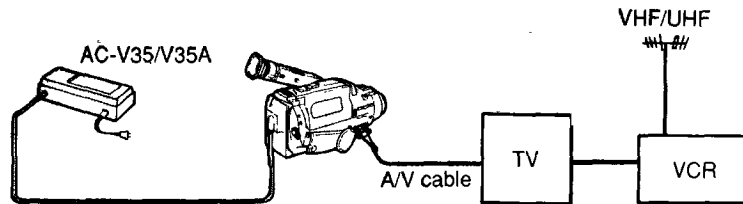

## Playing Back a Tape In Various Speeds

The supplied wireless Remote Commander is useful to control the camcorder from a distance. When using it, be sure to set the **☑** REMOTE COMMANDER ON/OFF switch to ON.

### To make the same indications in the viewfinder on the TV (only on the Commander)

Press DATA SCREEN.

To turn the indications off, press it again.

This DATA SCREEN on TV will tell you which playback mode you are using.

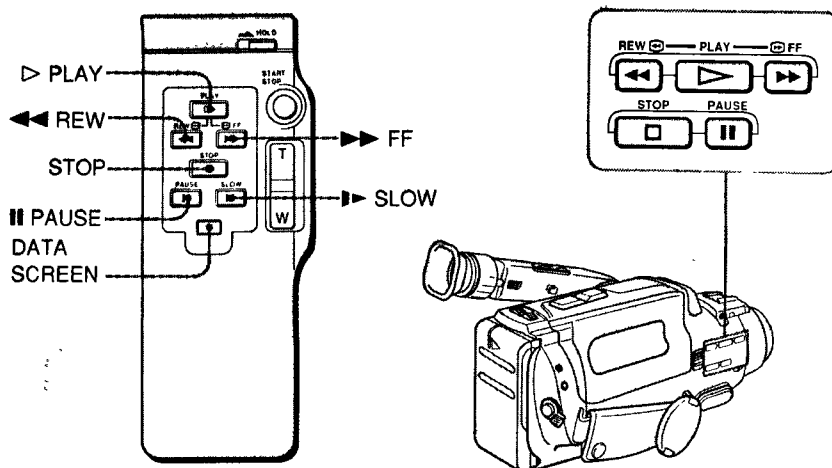

### To view the still picture (playback pause)

Press **||** during playback.

**||** appears in the viewfinder.

To resume normal playback, press **>** or **||**.

#### Note

When the still picture mode lasts for 5 minutes or more, the camcorder automatically enters the stop mode.

### To view the picture at 1/5 speed (slow playback) (only on the Commander)

Press **▶** during playback.

**▶** appears in the viewfinder.

#### Note

To resume normal playback, press **>**.

When slow playback lasts for 1 minute or more, the playback at the normal speed starts automatically.

### To locate the desired scene (picture search)

Keep pressing **<<** or **>>** during playback or in the still picture mode. **⏮** or **⏭** appears in the viewfinder.

To resume normal playback, release the button.

### To locate the desired scene quickly (skip scan)

Press **<<<** during rewinding or **>>>** during advancing the tape rapidly. **⏪** or **⏩** appears in the viewfinder.

To resume normal playback, press **>**.

### About the playback picture

During the various playback modes, streaks appear on the screen.

## Using the Tape Counter









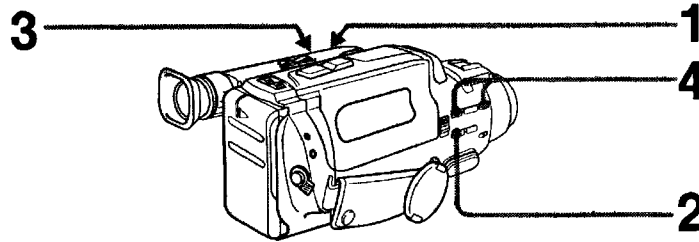

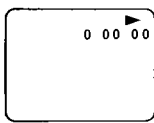
During recording or playback, the digits on the counter indicate the actual recording or playback time.

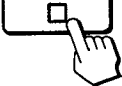
### To count the whole tape

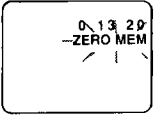
Press COUNTER RESET at the beginning of the tape so that the counter shows "0:00 00". Write down the counter reading at a particular point so that you can easily find that point later by referring to the tape counter.

### To return to a preset point



<p><b>1</b> During playback, press COUNTER RESET at the point you later want to locate. The counter shows "0:00:00".</p>	<p>COUNTER RESET</p>  
<p><b>2</b> Press  when the playback has finished, as usual.</p>	<p>STOP</p> 
<p><b>3</b> Press ZERO MEM. The "ZERO MEM" indicator blinks in the viewfinder. <b>Be sure to press ZERO MEM after you stop the tape.</b> It does not function during recording or playback</p>	<p>ZERO MEM</p>  
<p><b>4</b> Press  or .</p> <p>The tape rewinds or advances and stops automatically when the counter reaches approximately zero.</p>	<p>REW  </p> 

#### Notes on the tape counter and the ZERO MEM button

- Something must be recorded on the tape in order for the tape counter to function  
The tape counter will not work on blank tape
- The counter reading and the point of the tape may not correspond exactly Use the counter as a guide  
There will be a time lag of several seconds especially when you repeat fast-forward running/rewinding and play back the tape recorded in LP and SP modes mixed
- The ZERO MEM mode is cancelled automatically once the tape is rewound or sent forward to the point where you pre-registered

# Editing

## Editing Tapes with a VCR

You can edit a tape with an additional **U** 8mm, **B** Betamax or **VHS** VHS format VCR.

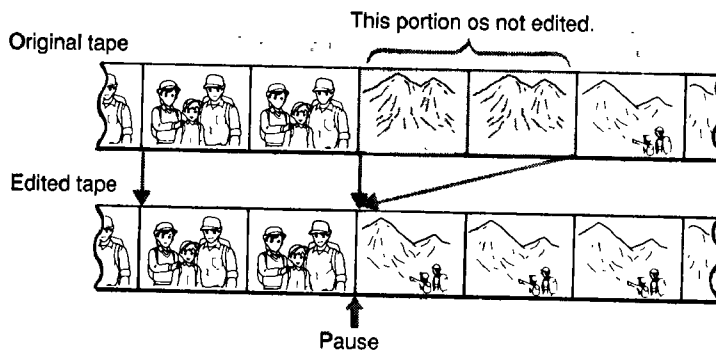

### How to connect

Make connections using the appropriate A/V cable (such as Sony VMC-710M/720M for monaural VCR or VMC-910MS/920MS for stereo VCR) and set the CHARGE/VTR selector on the AC power adaptor to VTR. Set the input selector of the VCR to LINE, if available.

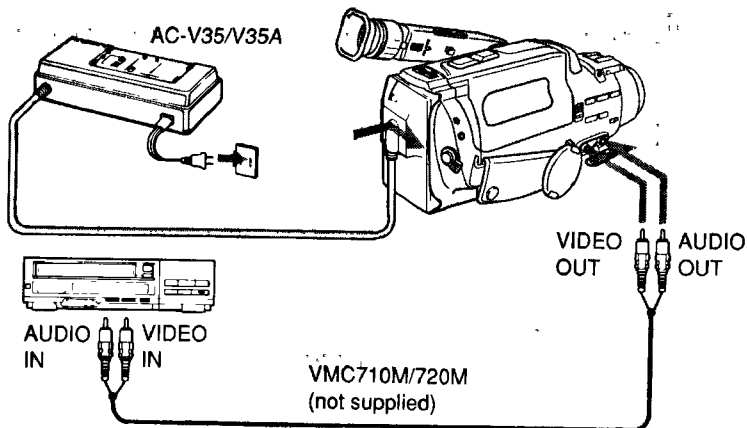

Editing

**How to edit**

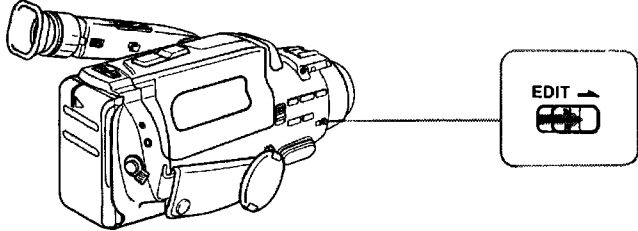
<b>1</b>	<b>Insert a tape to be recorded into recording VCR.</b>
<b>2</b>	<b>Slide EDIT on the camcorder to the direction of the arrow.</b>
	
<b>3</b>	<b>Set the POWER switch of the camcorder to PLAYER, then insert the recorded tape.</b>
<b>4</b>	<b>Play back a tape on the camcorder until you locate the point where you want to start editing, then press II PAUSE to set the camcorder to the playback pause mode.</b>
<b>5</b>	<b>On the recording VCR, locate the recording starting point and set the VCR to the recording pause mode.</b>
<b>6</b>	<b>Press II PAUSE on the camcorder and VCR simultaneously to start editing.</b>

**Editing more scenes**

Repeat steps 4 to 6.

**To stop editing momentarily**

Press II PAUSE on the recording VCR.

**To stop editing**

Press □ STOP on both VCRs.

**If you use the DATA SCREEN function**

The indicators displayed on the TV screen will also be recorded. If you don't want to record these indicators, press DATASCREEN on the Commander.

**Using of the EDIT switch**



When you set EDIT to the direction of the arrow (EDIT ON), you can keep picture and sound deteriorations resulting from editing to the minimum. Avoid using the edited tape for multiple generations of editing. After editing, be sure to set this switch in the opposite direction of the arrow (EDIT OFF).

**Moisture Condensation**

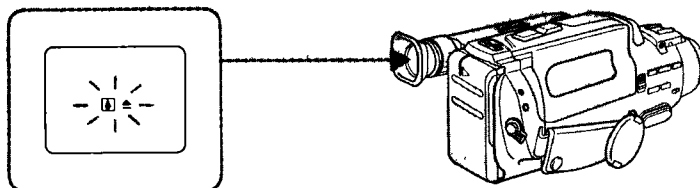
If the camcorder is brought directly from a cold place to a warm place, moisture may condense inside the camcorder, on the surface of the tape or on the lens. In this condition, the tape may stick to the head drum and be damaged or the unit may not operate correctly. To prevent possible damage under these circumstances, the camcorder is furnished with moisture sensors. However, take the following precautions.

**If moisture condenses inside the unit**

Moisture is present inside the camcorder when:

- The  indicator in the viewfinder blinks.  
When the tape is inserted, the  indicator also blinks.
- Several beeps sound continuously for five seconds when the BEEP switch is set to ON and the tape is inserted.



In such cases, no functions except for tape ejection work.

**Eject the tape, turn off the camcorder and leave it with the cassette holder open for at least 1 hour.**

The camcorder can be used again if the  indicator does not appear when the power is turned on again.

**If moisture condenses on the surface of the tape**

Moisture is present on the surface of the tape when

- The  indicator blinks inside the viewfinder when the tape is inserted and a tape transport button (, , etc.) is pressed.
- Several beeps sound continuously for about five seconds when the BEEP switch is set to ON.

In such cases, no functions except for tape ejection work.

**Eject the tape and let the camcorder and the tape sit for at least 1 hour.**

The tape can be used again if the  indicator does not appear when the tape is inserted and a tape transport button is pressed.

**If moisture condenses on the lens**

No caution indicators will appear, but the picture becomes dim.

**Turn off the power and don't use the camcorder for at least 1 hour.**

**How to prevent moisture condensation**

When bringing the camcorder from a cold place to a warm place, put the camcorder in a plastic bag and allow it to adapt to room conditions over a period of time.

- 1 Be sure to tightly seal the plastic bag containing the camcorder.
- 2 Remove the bag when the air temperature inside it has reached the temperature surrounding it (after about one hour).

## Video Head Cleaning

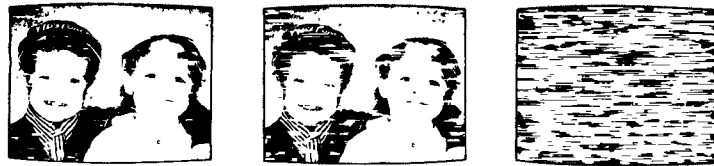

Slight contamination Critical contamination

### To ensure a clear picture, clean the video heads periodically

When playback pictures become noisy or hardly visible, the video heads may be contaminated. In such cases,

- 1 Clean the video heads with the Sony V8-25CLH cleaning cassette (not supplied), referring to its instructions.
- 2 After cleaning, check if the picture is clear by recording or playing back with an ordinary tape.
- 3 If the picture is still noisy, repeat cleaning. (Do not repeat cleaning more than 5 times.)

**Caution** Do not use a commercially available wet-type cleaning cassette. It may damage the video heads.

**Note** If the V8-25CLH cleaning cassette is not available in your area, consult your Sony service facility.

## Viewfinder Cleaning

### To clean the viewfinder

- 1 Pull the switch on the viewfinder barrel down.

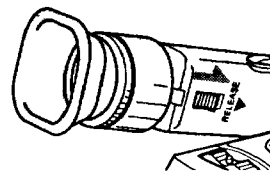

- 2 Turn the eyecup in the direction of the arrow and detach the eyecup.

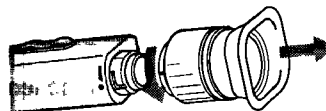

- 3 Clean the surface of the screen with a commercially available blower etc.

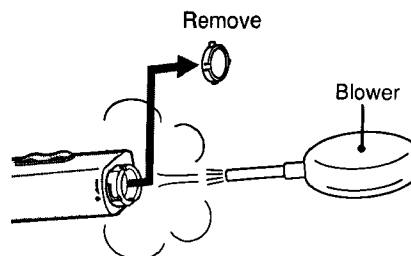



## To reattach the eyecup

- 1 Align the groove on the eyecup with the ● mark on the barrel.

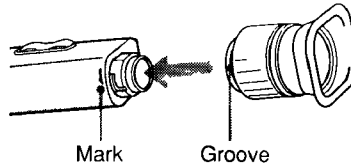

- 2 Turn the eyecup in the reverse direction of the arrow.

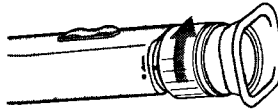

## Tips for Better Camera Recording

### How to Achieve Better Camera Recording

#### Take a good posture for shooting

For hand-held shots, it is important to hold the camcorder properly.

- Hold the camcorder firmly and secure it with the grip belt so that you can easily manipulate the camcorder with your thumb.
- Place your right elbow firmly against your side.
- Place your left hand under the camcorder to support it. When adjusting the focus manually, make sure the camcorder does not move.
- Stand opposite to the subject and take a comfortable stance.
- Place your eye firmly against the viewfinder eyecup.



#### Use a tripod

If you have a tripod for a still camera, you can also use it with the camcorder. If a tripod is not available, try placing the camcorder on a tabletop or any other flat surface of suitable height.

#### Caution

When attaching a tripod not manufactured by Sony, the length of the camera mounting screw must be less than 6.5 mm. Otherwise the screw may damage the inner part of the camera.

Less than 6.5 mm  
(<sup>9</sup>/<sub>32</sub> inches)

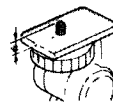

## Maintenance Information

### Keep the horizontal plane level

You can easily determine the horizontal plane by using the viewfinder frame as a reference.

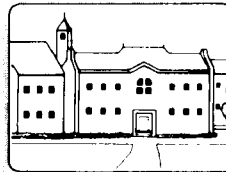

### Plan ahead

If you are going to edit the tape after recording, shoot the scene a little longer to make the editing easier.

### Lighting

Shoot with the sun behind you.

When the light source is behind the subject, or in the following situations, the subject will be recorded too dark and the background too light.

- The subject is indoors and there is a window behind the subject.
- Bright sources such as fluorescent or incandescent lamps are included in the scene.
- You are shooting a person wearing white or shiny clothes in front of a white background. In this case, the face will be recorded too dark.

### Use video light in the dark

To get the best colors, you must maintain a sufficient light level.

Photography lamps or halogen lamps are recommended. For best results, use of Sony video lights, since their weight and low heat output levels allow safe and direct connection to the camcorder.

Do not point the light at the camcorder. The high heat from the light may warp the casing of the camcorder.

For detailed instructions on proper use of the light, read its instruction manual.

## Using Your Camcorder Abroad

Each country has its own electricity system and TV color system. Before using your camcorder abroad, check the following points.

### Power Sources

You can use your camcorder in any country with the supplied AC power adaptor within 110 V to 240 V AC, 50/60 Hz.

### Difference In Color System

This camcorder is an NTSC system based camcorder. If you want to view the playback picture on a TV, it must be an NTSC system based TV or a PAL-M system based TV with NTSC/PAL-M transcoder. Check the following alphabetical list.

#### NTSC system countries

Bahama Islands, Bolivia, Canada, Central America, Chile, Colombia, Ecuador, Jamaica, Japan, Korea, Mexico, Peru, Surinam, Taiwan, The Philippines, U.S.A., Venezuela, etc.

#### PAL system countries

Australia, Austria, Belgium, China, Denmark, Finland, Germany (former West Germany), Great Britain, Holland, Hong Kong, Italy, Kuwait, Malaysia, Malaysia New Zealand, Norway, Portugal, Singapore, Spain, Sweden, Switzerland, Thailand, etc.

#### PAL M system country

Brazil

#### PAL N system countries

Argentina, Paraguay, Uruguay

#### SECAM system countries

Bulgaria, France, Guiana, Hungary, Iran, Iraq, Monaco, Poland, former Soviet Union, etc.

## Precautions

### On operation

- Operate the camcorder on 6.0 V (battery pack) or 7.5 V (AC power adaptor).
- For DC or AC operation, use the accessories recommended in this manual.
- Should any solid object or liquid fall into the casing, unplug the camcorder and have it checked by qualified personnel before operating it any further.
- Do not hold the camcorder by the viewfinder or the microphone.
- Avoid rough handling or mechanical shock. Be particularly careful of the lens.
- Keep the lens cap on the lens when not using the camera.
- Do not wrap up the camcorder and operate it since heat may build up internally.
- Keep the camcorder away from strong magnetic fields or mechanical vibration.
- **Do not let sand get into the camcorder.**  
When you use the camcorder on a sandy beach or dusty place, protect it from the sand or dust. Sand or dust may cause the camcorder to malfunction and sometimes the malfunction cannot be repaired.
- **Do not let the camcorder get wet.**  
Keep the camcorder from rain or sea water. It may cause malfunction and sometimes the malfunction cannot be repaired.

### On care

- When the unit will not be used for a long time, disconnect the power source and remove the tape. Periodically turn on the power, operate the camera section and player section and play back a tape for about 3 minutes.
- Clean the lens with a soft brush to remove dust. If there are fingerprints on it, remove them with a soft cloth. Clean the camcorder body with a dry, soft cloth, or a soft cloth lightly moistened with a mild detergent solution. Do not use any type of solvent which may damage the finish.

## Identifying the Parts

For details on the use of each part, refer to the pages indicated in the circle.

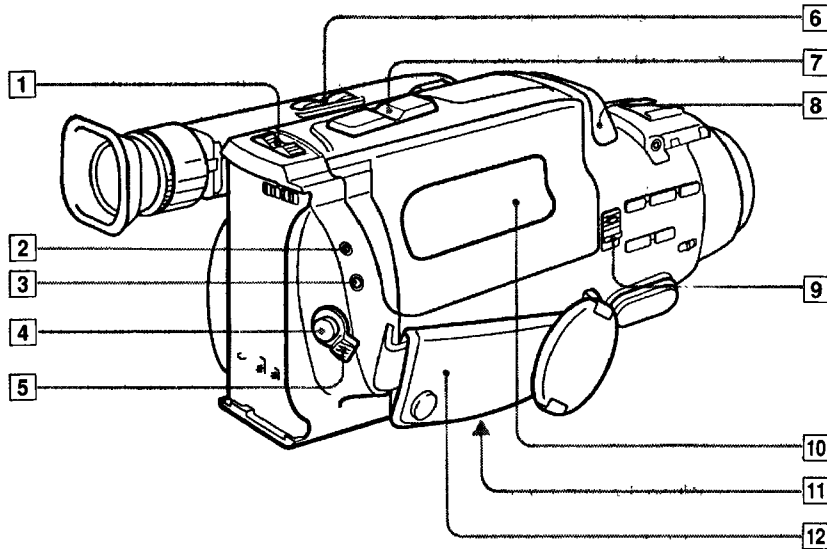

- 1** **POWER** switch  
CAMERA: for camera recording  
PLAYER: for playing back or editing tapes  
OFF: power off
- 2** **REMOTE** control connector (stereo mini-minijack) **29**
- 3** **(earphone) jack** (minijack)
- 4** **START/STOP** button
- 5** **STANDBY** switch
- 6** **EDITSEARCH** (and **RECORDING** review) button **26** **27** **28**
- 7** **Power zoom (MACRO)** button **16**
- 8** **Built-in microphone**
- 9** **EJECT** (cassette eject) knob **8**
- 10** **Cassette holder**
- 11** **Lithium battery holder**
- 12** **Grip belt** **14**

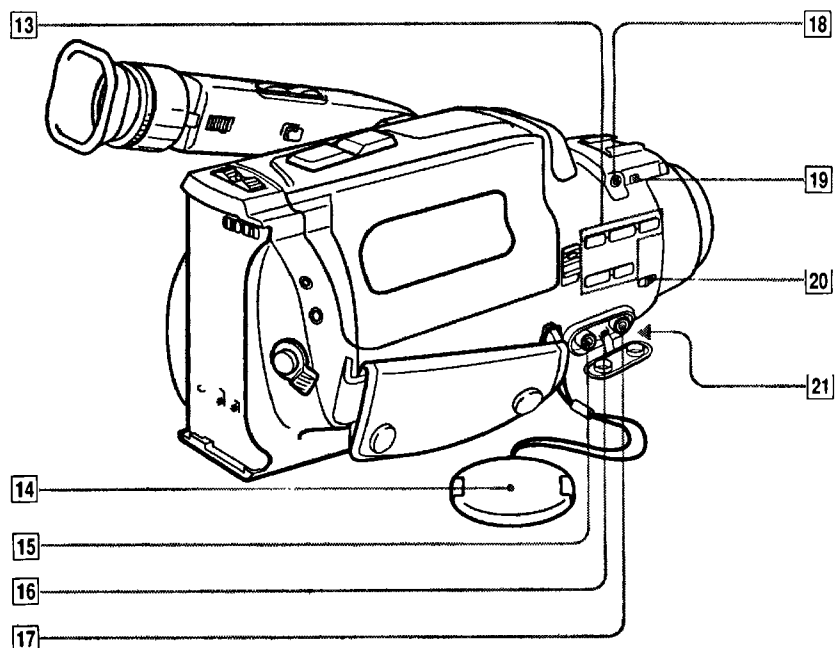

**13** Tape transport buttons 35

- ▷ PLAY (playback)
- ▶▶ FF (fast-forward)
- ◀◀ REW (rewind)
- STOP (stop)
- || PAUSE (pause)

**14** Lens cap

**15** VIDEO output jack (phono jack) 37

**16** RFU DC OUT (RFU adaptor DC output) jack (special miniJack)

**17** AUDIO output jack (phono jack) 37

**18** MIC jack (PLUG IN POWER) (mono mini-jack)

**19** Remote control sensor 19

**20** EDIT switch 38

**21** Hook for shoulder strap

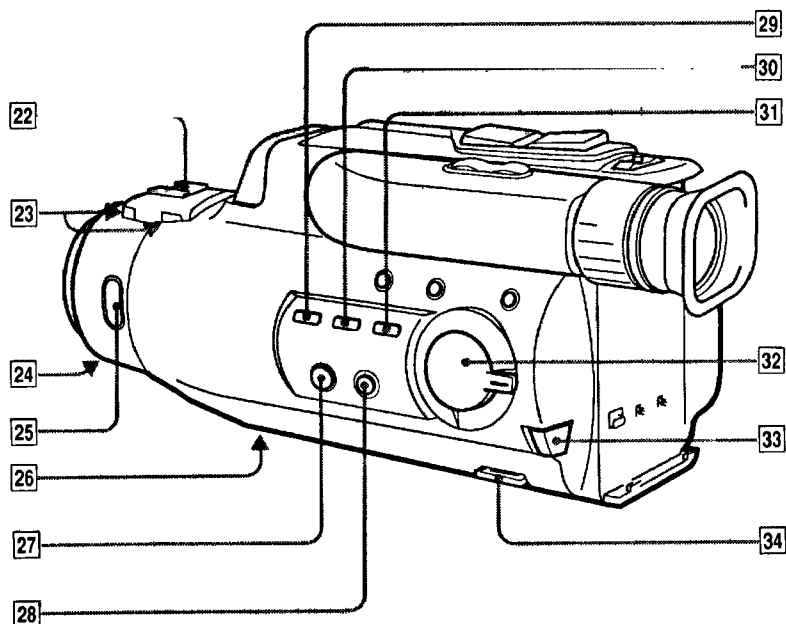

- 22** Accessory shoe
- 23** Remote control sensor **19**
- 24** Focus HOLD switch **30**
- 25** PUSH FOCUS HOLD button **30**
- 26** Tripod receptacle (bottom)
- 27** FADER button **32**
- 28** BACK LIGHT button **30**
- 29** DATE (+) button **11 12 24**
- 30** TIME (NEXT) button **11 12 24**
- 31** AGE/EVENT button **12 24**
- 32** PROGRAM AE selector **14 31**
- 33** BATT (battery eject) knob **7**
- 34** Hook for shoulder strap

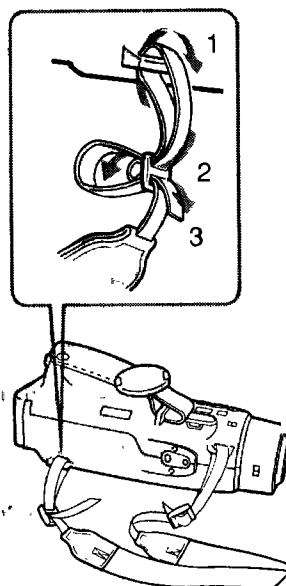

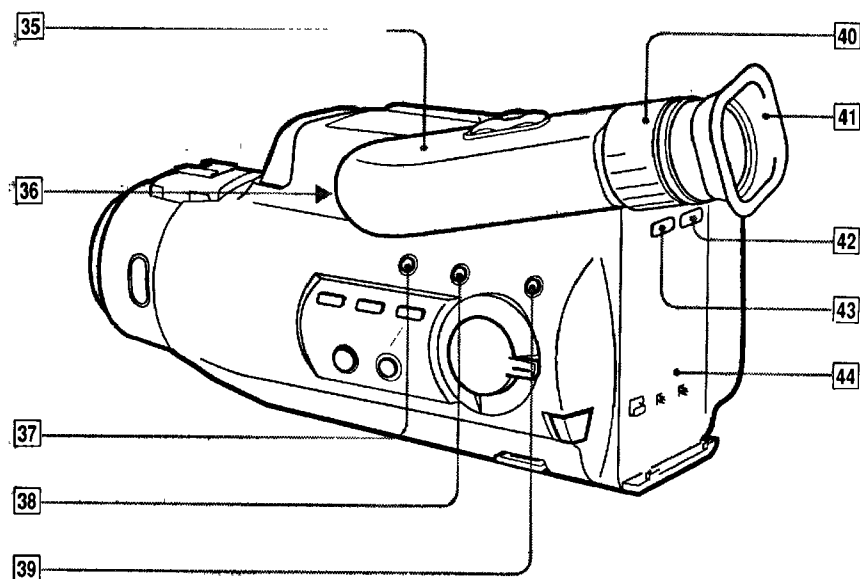

- 35** Viewfinder
- 36** Camera recording/battery lamp 50
- 37** COUNTER RESET button 28 36
- 38** ZERO MEM button 28 36
- 39** TAPE/BATT CHECK button 7 15
- 40** Viewfinder adjustment ring 9
- 41** Eyecup
- 42** BEEP ON/OFF switch 5
- 43**  REMOTE COMMANDER ON/OFF switch 19
- 44** Battery mounting surface

## Identifying the Parts

### Wireless Remote Commander

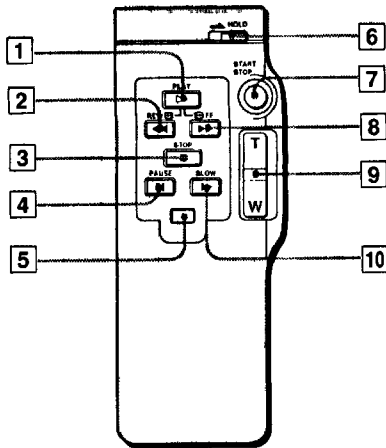

- 1 ▷ PLAY (play back) button 35
- 2 ◀◀ REW (rewind) button 35
- 3 □ STOP button
- 4 || PAUSE button 35
- 5 DATA SCREEN button 35
- 6 HOLD switch\* 19
- 7 START/STOP button
- 8 FF ▶▶ (fast forward) button 35
- 9 Power zoom button
- 10 ▶ SLOW (slow playback) button 35

#### Note

The \* indicates the functions which are operable only with the commander.

### Inside the Viewfinder

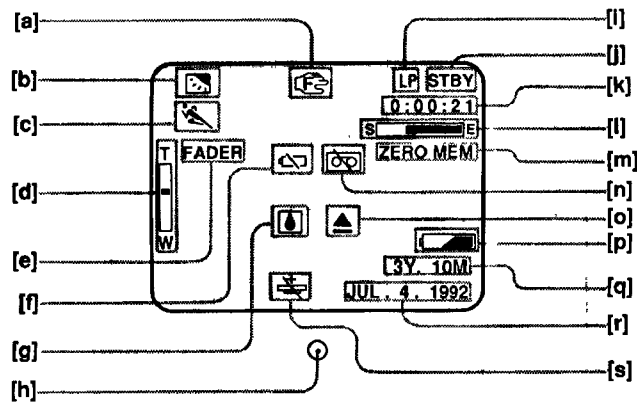

- [a] Focus is maintained (35)
- [b] BACK LIGHT is pressed (35)
- [c] PROGRAM AE setting (35, 35, 35)
- [d] Power zoom indicator
- [e] FADER is pressed
- [f] "Exchange battery" (35)
- [g] Moisture has condensed (35)
- [h] Lights up during recording  
When blinking: "Exchange battery or tape"
- [i] Playback mode (LP)
- [j] Tape transport mode
- [k] Tape counter
- [l] Remaining time of tape
- [m] ZERO MEM is pressed
- [n] "Exchange tape or no tape inside" (35)
- [o] "Trouble has occurred" (35)  
"Clean video heads" (35)
- [p] Remaining capacity of a battery
- [q] Age
- [r] Date or Time
- [s] "Replace lithium battery" (35)



# Trouble Check

If you run into any problems during operation, use the following table to troubleshoot the problem. Should the difficulty persist, unplug the unit and contact your Sony dealer or local authorized Sony service facility.







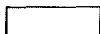







Symptom	Cause	Corrective actions
The power does not turn on.	The battery is not attached.	Attach the battery.
	The battery is used up.	Use a charged battery.
	The AC power adaptor is not connected to a wall outlet.	Connect the adaptor to a wall outlet.
The power turns off.	While being operated in CAMERA mode, the camcorder has been in the pause mode for more than 5 minutes.	Turn down the STANDBY switch, and turn it up again.
	The battery is used up.	Use a charged battery.
The battery pack is quickly discharged.	The ambient temperature is too low.	—
	The battery pack has not been charged fully.	Charge the battery pack again.
The START/STOP button does not operate.	The tape is affixed to the drum.	Eject the tape.
	The tape is at its end.	Rewind the tape or use a new one.
	The POWER switch is set to VTR.	Set it to CAMERA.
	The tab on the tape is out (red).	Use a new tape or slide the tab.
The tape cannot be removed from the compartment.	The battery is used up.	Use a charged battery or the AC power adaptor.
No function except for tape ejection works.	Moisture condensation has occurred. (See page 39.)	Remove the tape and don't use the camcorder for at least an hour.
The tape does not move when a tape transport button is pressed.	The POWER switch is set to CAMERA or OFF.	Set it to PLAYER.
	The tape is at its end.	Rewind the tape or use a new one.
The autofocusing function does not work.	FOCUS HOLD switch is set to the direction of the arrow. (See page 30).	Set the FOCUS HOLD switch to the opposite direction of the arrow.
The image on the viewfinder screen is not clear.	The viewfinder lens is not adjusted.	Adjust the viewfinder lens.
A vertical band appears when a subject such as lights or a candle flame is shot against a dark background.	The contrast between the subject and background is too high; the camera is not malfunctioning.	—
The playback picture is not clear.	EDIT is set in the direction of the arrow.	Set EDIT in the opposite direction of the arrow.
	The channel or input for the camcorder is not selected on the TV.	Select correctly.
The picture is noisy.	The video heads may be contaminated.	Clean the heads using the Sony V8-25CLH (See page 40.) cleaning cassette.

## Trouble Check

If an indication blinks in the viewfinder screen or a caution lamp on the main unit blinks, check the following table.

 slow blinking

 fast blinking

	Symptom	Cause	Corrective actions
Camera operation VCR operation	 Battery lamp	The battery is weak.	Prepare a charged one.
	 Battery lamp	The battery is used up.	Use a charged battery.
Camera operation	   Beeps	The tape is at its end.	Use a new tape.
	 Battery lamp	The tape is near its end.	Prepare a new one.
	 Battery lamp	No tape is inserted.	Insert a tape.
	  Beeps	The tab on the tape is out (red).	Slide the tab.
Camera operation VCR operation	 or  Beeps	Moisture condensation has occurred.	Remove the tape and leave the camcorder for at least an hour.
	 Caution lamp	The gap of the head is clogged.	Clean the head using the Sony V8-25CLH video head cleaning tape.
	 Beeps	Other troubles may occur.	Consult your nearest Sony dealer.
	 flashes for 5 seconds in the viewfinder after setting the POWER switch to CAMERA.	The lithium battery is not installed. The lithium battery is exhausted. The lithium battery is weak.	Install a lithium battery with the battery pack or other power source attached. Otherwise, you must readjust the date, time and birth dates.

# Specifications

## System

Video recording system	Rotary two heads, Helical scanning FM system
Audio recording system	Rotary head, FM system
Video signal	NTSC color, EIA standards
Usable cassette	8 mm video format cassette
Tape speed	SP mode: Approx. 1.43 cm (1 <sup>9</sup> / <sub>32</sub> inch)/sec. LP mode: Approx. 0.72 cm (5 <sup>9</sup> / <sub>16</sub> inch)/sec. (playback only)
Recording time	SP mode: 2 hours (P6-120)
Playback time	SP mode: 2 hours (P6-120) LP mode: 4 hours (P6-120)
Fast forward/rewind time	Approx. 6 min. 30 sec. (P6-120)
Image device	CCD (Charge Coupled Device)
Viewfinder	Electronic viewfinder (black and white)
Lens	Combined 8x power zoom lens f=6.1 to 48.8 mm (1/4 to 1 <sup>15</sup> / <sub>16</sub> inches) Approx. 44 to 352 mm (1 <sup>3</sup> / <sub>4</sub> to 13 <sup>7</sup> / <sub>8</sub> inches) converted into the focal length of a 35-mm still camera. F 1.6 with macro Filter diameter: 37 mm (1 <sup>1</sup> / <sub>2</sub> inches) TTL autofocus system inner focus wide macro system
Color temperature	AUTO
Minimum illumination	2 lx
Illumination range	2 lx to 100,000 lx (0.2 to 9294 footcandles)
Recommended illumination	More than 100 lx (9 footcandles)
Aperture correction	Automatic With backlight adjustment

## Input and output connector

Video output	Phono jack, 1 Vp-p, 75 ohms unbalanced sync negative
Audio output	Phono jack Output: -7.5 dBs, (at output impedance 47 kilohms) impedance less than 1 kilohms

RFU DC OUT	Special minijack, 5 V DC
Earphone jack	Minijack, 8-ohm impedance
Remote  jack	Stereo mini-minijack
MIC jack	Minijack, -66 dBs, low impedance with 2.5 to 3 V DC output, impedance 6.8 kilohms
Microphone power output jack	Special minijack, 5 V DC

## General

Power requirements	On battery mounting surface 6.0 V (battery pack) 7.5 V (AC power adaptor)
Power consumption	5.5 W (camera recording) including the viewfinder
Installation	Vertically, horizontally
Operating temperature	0°C to 40°C (32°F to 104°F)
Storage temperature	-20°C to +60°C (-4°F to +140°F)
Dimensions	Approx. 118 × 108 × 265 mm (w/h/d) (4 <sup>3</sup> / <sub>4</sub> × 4 <sup>3</sup> / <sub>8</sub> × 10 <sup>1</sup> / <sub>2</sub> in.)
Weight	Approx. 820 g (1 lb 13 oz) excluding the battery pack, lithium battery, and cassette Approx. 1012 g (2 lb 3 oz) including the battery pack NP-55, lithium battery CR2025, and cassette P6-120
Microphone	Electret condenser microphone, uni-directional, monaural type

## Wireless Remote Commander

Remote control system	Infrared control
Command mode	VTR 2
Power requirements	3 V DC, 2 size AA (R6) batteries
Dimensions	Approx. 48 × 19 × 130 mm (w/h/d) (1 <sup>15</sup> / <sub>16</sub> × 3/4 × 5 <sup>1</sup> / <sub>8</sub> inches)
Weight	Approx. 50 g (1.8 oz) (excluding batteries)

Design and specifications are subject to change without notice.

# Index

## A

AC Adaptor .....	6, 22
Accessory Shoe .....	29
Adjusting Viewfinder .....	9
Age Button .....	12, 25
Audio Output .....	33
Audio/Video Cable .....	33

## B

Back Light .....	30
Battery .....	6
Battery lamp .....	50
Battery Pack .....	6
Beep .....	5

## C

Camera Mode .....	14
Camera Recording Lamp .....	15
Car battery operation .....	23
Charging Battery .....	6
Cleaning Video Head .....	40
Clock Set .....	11
Close-up .....	16
Connection .....	17, 33
Counter Reset .....	28, 36

## D,E

Data Screen .....	35
Date/Time .....	24
Dew Indication .....	39
Earphone Jack .....	26
Edit Switch .....	38
Editing .....	37
Editsearch .....	26
Eject .....	15
Exposure .....	31
External Microphone Jack .....	29
Eyecup .....	40

## F,G,H

Fade in/Fade out .....	32
Fast-Forward .....	18
Focus Hold .....	30
High Speed Shutter .....	31
Hold Switch .....	19

## I,J,K,L

Indoor .....	22
Insert .....	28
LANC .....	29
Lens Cap .....	14
Lithium Battery .....	10

## M,N,O,P

Pause Button .....	35
Play .....	18
Playback on TV .....	17, 33
PLAYER Mode .....	18
Portrait Mode .....	31
Power Sources .....	22
Power Zoom .....	16
Program AE .....	31
Push Focus Hold .....	30

## R

Rec Review .....	26
Record/Pause .....	15
Remote Commander .....	19
Remote Control Jack .....	29
Rewind .....	18
RFU Adaptor .....	17

## S

Shoulder Strap .....	46
Skip-scan .....	35
Slow .....	35
Specifications .....	51
Sports finder .....	9
Sports Mode .....	31
Standby .....	15
Still Picture .....	35
Stop .....	18
Supplied Accessories .....	5

## T,U,V

Tape/Batt Check .....	7, 15
Tape Counter .....	36
Tripod Mounting .....	41
Troubles .....	49
VHF Antenna .....	17, 33
Video Cassette Tapes .....	8
Viewfinder Indicator .....	48

## W,X,Y,Z

Warning .....	50
Wireless Remote Commander .....	19
Zero Mem .....	28, 36
Zoom .....	16

If you have any question about this product, you may call:

### Sony Customer Information Center

East Coast : 201-930-7669 (SONY) NJ  
Central : 708-250-7669 (SONY) IL  
West Coast : 714-821-7669 (SONY) CA

or write to:

Sony Customer Information Center  
Sony Drive, Mail Drop #T1-11,  
Park Ridge, NJ 07656

## Free Manuals Download Website

<http://myh66.com>

<http://usermanuals.us>

<http://www.somanuals.com>

<http://www.4manuals.cc>

<http://www.manual-lib.com>

<http://www.404manual.com>

<http://www.luxmanual.com>

<http://aubethermostatmanual.com>

Golf course search by state

<http://golfingnear.com>

Email search by domain

<http://emailbydomain.com>

Auto manuals search

<http://auto.somanuals.com>

TV manuals search

<http://tv.somanuals.com>