

EN

User manual

Cooker

# USER MANUAL

ZCV48300BA  
ZCV48300XA  
ZCV48300WA

**ZANUSSI**

## Contents

---

Safety information _____	2	Oven - Helpful hints and tips _____	12
Safety instructions _____	3	Oven - Care and cleaning _____	16
Product description _____	6	What to do if... _____	18
Before first use _____	7	Installation _____	19
Hob - Daily use _____	8	Environment concerns _____	20
Hob - Helpful hints and tips _____	8	GREAT BRITAIN & IRELAND - Guarantee/ Customer Service _____	20
Hob - Care and cleaning _____	8	European Guarantee _____	21
Oven - Daily use _____	9		
Oven - Clock functions _____	11		

Subject to change without notice.

## Safety information

---

Before the installation and use of the appliance, carefully read the supplied instructions. The manufacturer is not responsible if an incorrect installation and use causes injuries and damages. Always keep the instructions with the appliance for future reference.

### Children and vulnerable people safety

**⚠ Warning!** Risk of suffocation, injury or permanent disability.

- This appliance can be used by children aged from 8 years and above and persons with reduced physical, sensory or mental capabilities or lack of experience and knowledge if they are supervised by an adult or a person who is responsible for their safety.
- Do not let children play with the appliance. Children under 3 years must not be left unsupervised in the vicinity of the appliance.
- Keep all packaging away from children.
- Keep children and pets away from the appliance when it operates or when it cools down. Accessible parts are hot.
- If the appliance has a child safety device, we recommend that you activate it.
- Cleaning and user maintenance shall not be made by children without supervision.

## General Safety

- The appliance and its accessible parts become hot during use. Do not touch the heating elements.
- Do not operate the appliance by means of an external timer or separate remote-control system.
- Unattended cooking on a hob with fat or oil can be dangerous and may result in fire.
- Never try to extinguish a fire with water, but switch off the appliance and then cover flame e.g. with a lid or a fire blanket.
- Do not store items on the cooking surfaces.
- Do not use a steam cleaner to clean the appliance.
- Metallic objects such as knives, forks, spoons and lids should not be placed on the hob surface since they can get hot.
- Do not use harsh abrasive cleaners or sharp metal scrapers to clean the glass door since they can scratch the surface, which may result in shattering of the glass.
- If the glass ceramic surface is cracked, switch off the appliance to avoid the possibility of electric shock.
- Ensure that the appliance is switched off before replacing the lamp to avoid the possibility of electric shock.
- The means for disconnection must be incorporated in the fixed wiring in accordance with the wiring rules.
- If the supply cord is damaged, it must be replaced by the manufacturer, an authorized Service or similarly qualified persons in order to avoid a hazard.



### Safety instructions

---

#### Installation



**Warning!** Only a qualified person must install this appliance.

- Remove all the packaging.
- Do not install or use a damaged appliance.
- Obey the installation instruction supplied with the appliance.
- Always be careful when you move the appliance because it is heavy. Always wear safety gloves.
- Do not pull the appliance by the handle.

- Keep the minimum distance from the other appliances and units.
- Make sure that the appliance is installed below and adjacent safe structures.
- The sides of the appliance must stay adjacent to appliances or to units with the same height.
- Do not install the appliance on a platform.
- Do not install the appliance adjacent to a door or under a window. This prevents hot cookware to fall from the appliance when the door or the window is opened.

 **Warning!** Make sure to install a stabilizing means in order to prevent tipping of the appliance. Refer to Installation chapter.

### Electrical connection

 **Warning!** Risk of fire and electrical shock.

- All electrical connections should be made by a qualified electrician.
- The appliance must be earthed.
- Make sure that the electrical information on the rating plate agrees with the power supply. If not, contact an electrician.
- Always use a correctly installed shockproof socket.
- Do not use multi-plug adapters and extension cables.
- Make sure not to cause damage to the mains plug and to the mains cable. Contact the Service or an electrician to change a damaged mains cable.
- Do not let mains cables to come in touch with the appliance door, specially when the door is hot.
- The shock protection of live and insulated parts must be fastened in such a way that it cannot be removed without tools.
- Connect the mains plug to the mains socket only at the end of the installation. Make sure that there is access to the mains plug after the installation.

- If the mains socket is loose, do not connect the mains plug.
- Do not pull the mains cable to disconnect the appliance. Always pull the mains plug.
- Use only correct isolation devices: line protecting cut-outs, fuses (screw type fuses removed from the holder), earth leakage trips and contactors.
- The electrical installation must have an isolation device which lets you disconnect the appliance from the mains at all poles. The isolation device must have a contact opening width of minimum 3 mm.

### Use

 **Warning!** Risk of injury, burns or electric shock.

- Use this appliance in a household environment.
- Do not change the specification of this appliance.
- Make sure that the ventilation openings are not blocked.
- Do not let the appliance stay unattended during operation.
- Deactivate the appliance after each use.
- Internally the appliance becomes hot when in operation. Do not touch the heating elements that are in the appliance. Always use oven gloves to remove or put in accessories or ovenware.
- Be careful, when you open the appliance door while the appliance is in operation. Hot air can release.
- Do not operate the appliance with wet hands or when it has contact with water.
- Do not apply pressure on the open door.
- Do not use an external timer or a separate remote-control system to operate the appliance.
- Always keep the appliance door closed when the appliance is in operation.
- Do not put cutlery or saucepan lids on the cooking zones. They become hot.
- Set the cooking zone to "off" after use.

- Do not use the appliance as a work surface or as a storage surface.
- If the surface of the appliance is cracked, disconnect immediately the appliance from the power supply. This to prevent an electrical shock.

 **Warning!** Risk of fire or explosion.

- Fats and oil when heated can release flammable vapours. Keep flames or heated objects away from fats and oils when you cook with them.
- The vapours that very hot oil releases can cause spontaneous combustion.
- Used oil, that can contain food remnants, can cause fire at a lower temperature than oil used for the first time.
- Do not put flammable products or items that are wet with flammable products in, near or on the appliance.
- Do not let sparks or open flames to come in contact with the appliance when you open the door.
- Open the appliance door carefully. The use of ingredients with alcohol can cause a mixture of alcohol and air.
- Do not try to extinguish a fire with water. Disconnect the appliance and cover the flame with a lid or a fire blanket.

 **Warning!** Risk of damage to the appliance.

- To prevent damage or discoloration to the enamel:
  - Do not put ovenware or other objects in the appliance directly on the bottom.
  - Do not put aluminium foil directly on the bottom of the appliance.
  - do not put water directly into the hot appliance.
  - do not keep moist dishes and food in the appliance after you finish the cooking.
  - be careful when you remove or install the accessories.

- Discoloration of the enamel has no effect on the performance of the appliance. It is not a defect in the sense of the warranty law.
- Use a deep pan for moist cakes. Fruit juices cause stains that can be permanent.
- Do not keep hot cookware on the control panel.
- Do not let cookware to boil dry.
- Be careful not to let objects or cookware fall on the appliance. The surface can be damaged.
- Do not activate the cooking zones with empty cookware or without cookware.
- Do not put aluminium foil on the appliance.
- Cookware made of cast iron, aluminium or with a damaged bottom can cause scratches on the glass ceramic. Always lift these objects up when you have to move them on the cooking surface.

### Care and Cleaning

 **Warning!** Risk of injury, fire or damage to the appliance.

- Before maintenance, deactivate the appliance and disconnect the mains plug from the mains socket.
- Make sure the appliance is cold. There is the risk that the glass panels can break.
- Replace immediately the door glass panels when they are damaged. Contact the Service.
- Be careful when you remove the door from the appliance. The door is heavy!
- Clean regularly the appliance to prevent the deterioration of the surface material.
- Remaining fat or food in the appliance can cause fire.
- Clean the appliance with a moist soft cloth. Only use neutral detergents. Do not use abrasive products, abrasive cleaning pads, solvents or metal objects.
- If you use an oven spray, obey the safety instructions on the packaging.
- Do not clean the catalytic enamel (if applicable) with any kind of detergent.

## Internal light

- The type of light bulb or halogen lamp used for this appliance, is only for household appliances. Do not use it for house lighting.

**Warning!** Risk of electrical shock.

- Before replacing the lamp, disconnect the appliance from the power supply.
- Only use lamps with the same specifications.

## Service

- Contact the Service to repair the appliance. We recommend only the use of original spare parts.

## Product description

### General overview

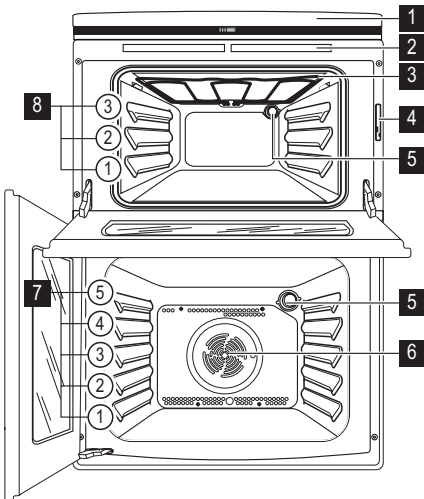

## Disposal

**Warning!** Risk of injury or suffocation.

- Disconnect the appliance from the mains supply.
- Cut off the mains cable and discard it.
- Remove the door catch to prevent children and pets to get closed in the appliance.

## Cooking surface layout

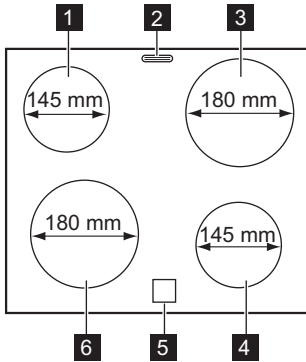

- 1 Cooking zone 1200 W
- 2 Steam outlet
- 3 Cooking zone 1700 W
- 4 Cooking zone 1200 W
- 5 Residual heat indicator
- 6 Cooking zone 1700 W

## Control panel

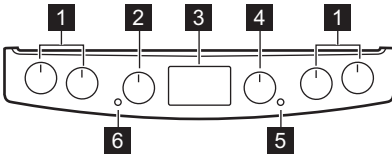

- 1 Knobs for the hob
- 2 Knob for the top oven functions
- 3 Electronic programmer
- 4 Knob for the main oven functions
- 5 Main oven temperature indicator
- 6 Top oven temperature indicator

## Accessories

- **Deep grill roasting pan**  
To bake and roast or as pan to collect fat.
- **The roasting pan grid**

To put in the deep roasting pan.

- **Oven shelf**  
For cookware, cake tins, roasts.

## Before first use

**Warning!** Refer to the Safety chapters.

### Initial Cleaning

- Remove all parts from the appliance.
- Clean the appliance before first use.

**Important!** Refer to chapter "Care and Cleaning".

### Setting the time



- i** You must set the time before you operate the oven.

When you connect the appliance to the electrical supply or after a power cut, the indicator for the Time of Day function flashes.

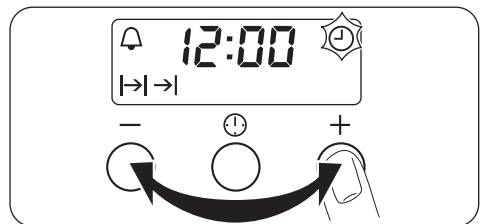
Press the **+** or **-** button to set the correct time.



After approximately five seconds, the flashing stops and the display shows the time of day you set.

 To change the time, press  again and again until the indicator for the Time of Day function flashes. You must not set the Duration  $\rightarrow$  or End  $\rightarrow$  function at the same time.

### Preheating

Set an oven function and maximum temperature and run an empty oven for 45 minutes, to

burn off any residue from the cavity surface. Accessories can become hotter than in normal use. During this period an odour can be emitted. This is normal. Make sure the room is well ventilated.

Preheat the two ovens. Heat up one oven at a time.

## Hob - Daily use

 **Warning!** Refer to the Safety chapters.

### Heat settings

Control knob	Function
0	Off position
1-6	Heat settings (1 = lowest heat setting; 6 = highest heat setting)

1. Turn the control knob to a necessary heat setting.
2. To complete the cooking process, turn the control knob to the "0" position.

### Residual heat indicator

The residual heat indicator comes on when a cooking zone is hot.

 **Warning!** Risk of burns from residual heat!

## Hob - Helpful hints and tips

 **Warning!** Refer to the Safety chapters.

### Cookware

-  The bottom of the cookware must be as thick and flat as possible.
- Cookware made of enamelled steel and with aluminium or copper bottoms can cause discoloration on glass ceramic surface.

### Energy saving

-  If possible, always put the lids on the cookware.
- Put cookware on a cooking zone before you start it.
- Stop the cooking zones before the end of the cooking time to use residual heat.

- The bottom of pans and cooking zones must have the same dimension.

### Examples of cooking applications

Heat setting:	Use to:
1	Keeping warm
2	Gentle simmering
3	Simmering
4	Frying / browning
5	Bringing to the boil
6	Bringing to the boil / quick frying / deep-frying

## Hob - Care and cleaning

 **Warning!** Refer to the Safety chapters.

Clean the appliance after each use. Always use cookware with clean bottom.

 Scratches or dark stains on the glass ceramic have no effect on how the appliance operates.



### To remove the dirt:

1. – **Remove immediately:** melted plastic, plastic foil, and food with sugar. If not, the dirt can cause damage to the appliance. Use a special scraper for the glass. Put the scraper on the glass surface at an acute angle and move the blade on the surface.  
– **Remove after the appliance is sufficiently cool:** limescale rings, water

rings, fat stains, shiny metallic discolorations. Use a special cleaning agent for glass ceramic or stainless steel.

2. Clean the appliance with a moist cloth and some detergent.
3. At the end **rub the appliance dry with a clean cloth.**

## Oven - Daily use

 **Warning!** Refer to the Safety chapters.

### Cooling fan





When the appliance operates, the cooling fan switches on automatically to keep the surfaces of the appliance cool. If you switch off the appliance, the cooling fan continues to operate until the appliance cools down.

### Activating and deactivating the ovens

1. Turn the knob for the top oven or the knob for the main oven to the necessary settings.



2. The temperature indicator comes on while the temperature in the appliance increases.
3. To deactivate an oven, turn the knob to the off position.

### Top oven functions

Oven function		Application
	OFF position	The appliance is OFF.
	Oven lamp	To illuminate the oven interior.
100-250	Conventional Cooking	This function is particularly suitable for cooking larger quantities of food.
	Dual Circuit Grill	To grill food items in medium quantities in the middle of the shelf. To make toast.
	Full Grill	The full grill element is on. To grill flat food items in large quantities. To make toast.

### Main oven functions

Oven function		Application
	OFF position	The appliance is OFF.

Oven function		Application
	Oven lamp	To illuminate the oven interior.
	Defrost	To thaw frozen food. The knob for the temperature must be on the OFF position.
100-250	Thermaflow	This function is particularly suitable for cooking larger quantities of food.

## Grilling set

The grilling set includes the roasting pan grid and the deep roasting pan. You can use the roasting pan grid on the two sides.

 **Warning!** Risk of burns when removing the accessories from a hot oven.

You can use the grilling set to roast larger pieces of meat or poultry on one level:

You can use the grilling set to grill flat dishes in large quantities and to toast:

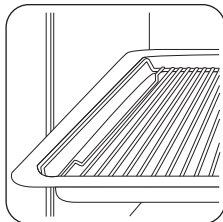

Put the roasting pan grid inside the deep roasting pan so that the supports of the oven shelf point upwards.

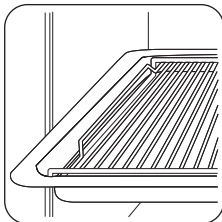

Put the roasting pan grid inside the deep roasting pan so that the supports of the oven shelf point downwards.

Put the deep roasting pan in the oven at the necessary level.

# Oven - Clock functions

## Electronic programmer

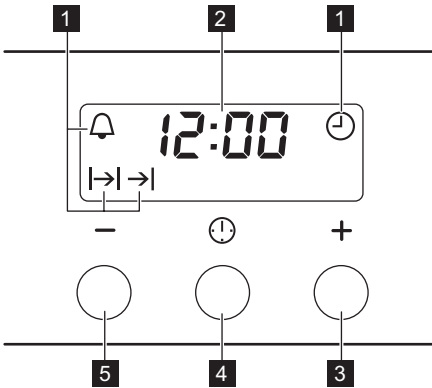

- 1 Function indicators
- 2 Time display
- 3 Button +
- 4 Selection button
- 5 Button -

Clock function		Application
	Time of day	To set, change or check the time of day.
	Minute Minder	To set a countdown time. An acoustic signal sounds after the time period is completed. <b>This function has no effect on the operation of the oven.</b>
	Duration	To set how long the appliance must operate.
	End	To set when the appliance must be deactivated.

**i** You can use Duration and End at the same time to set the time when the appliance must be activated and then deactivated. First set Duration , then End .

### Setting the clock functions

- For Duration and End , set an oven function and temperature. This is not necessary for the Minute Minder .
- Press the Selection button again and again until the indicator for the necessary clock function flashes.



- Press **+** or **-** to set the necessary clock function.  
The display shows the indicator for the clock function you set. When the set time ends, the indicator flashes and an acoustic signal sounds for two minutes.

**i** With the Duration and End functions, the appliance deactivates automatically.

- Press a button to stop the signal.

- Turn the knob for the oven functions and the knob for the temperature to the off position.

### Cancelling the clock functions

- Press the Selection button again and again until the necessary function indicator flashes.

- Press and hold the button -. The clock function goes out after some seconds.

## Oven - Helpful hints and tips

 **Warning!** Refer to the Safety chapters.

 The temperature and baking times in the tables are guidelines only. They depend on the recipes, quality and quantity of the ingredients used.

 **Caution!** Use a Deep grill roasting pan for very moist cakes. Fruit juices can cause permanent stains on the enamel.

### Top oven

The top oven is the smaller of the two ovens. It has 3 shelf levels. Use it to cook smaller quantities of food. It gives especially good results when used to cook fruitcakes, sweets and savoury flants or quiche.

### Main oven

The main oven is particularly suitable for cooking larger quantities of food.

### Baking

#### General instructions

- Your new oven may bake or roast differently to the appliance you had before. Adapt your

usual settings (temperature, cooking times) and shelf levels to the values in the tables.

- With longer baking times, the oven can be switched off about 10 minutes before the end of baking time, to use the residual heat.

**When you use frozen food, the trays in the oven can twist during baking. When the trays get cold again, the distortion will be gone.**

#### How to use the Baking Tables

- We recommend to use the lower temperature the first time.
- If you cannot find the settings for a special recipe, look for the one that is almost the same.
- Baking time can be extended by 10-15 minutes, if you bake cakes on more than one level.
- Cakes and pastries at different heights do not always brown equally at first. If this occurs, do not change the temperature setting. The differences equalize during the baking procedure.

## Tips on baking

Baking results	Possible cause	Remedy
The cake is not browned sufficiently below	Incorrect oven level	Put the cake on a lower oven level
The cake sinks (becomes soggy, lumpy, streaky)	Oven temperature too high	Use a lower setting
The cake sinks (becomes soggy, lumpy, streaky)	Baking time is too short	Set a longer baking time <b>Do not set higher temperatures to decrease baking times</b>

Baking results	Possible cause	Remedy
The cake sinks (becomes soggy, lumpy, streaky)	Too much liquid in the mixture	Use less liquid. Look at the mixing times, specially when you use mixing machines
Cake is too dry	Oven temperature too low	Set a higher oven temperature
Cake is too dry	Baking time too long	Set a shorter baking time
Cake does not brown equally	Oven temperature too high and baking time too short	Set a lower oven temperature and a longer baking time
Cake does not brown equally	No equal mixture	Put the mixture equally on the baking tray
Cake does not cook in the baking time set	Temperature too low	Use a slightly higher oven temperature setting

## Top Oven

**i** Shelf Positions are not critical but ensure that oven shelves are evenly spaced

when more than one is used (e.g. shelf positions 1 and 3)

## Baking

Food	Shelf Position	Temperature [°C]	Approx Cook Time (mins)
Biscuits	2	170 - 190	10 - 20
Bread	2	200 - 220	30 - 35
Bread rolls/buns	2	200 - 220	10 - 15
Cakes: Small & Queen	2	160 - 180	18 - 25
Cakes: Sponges	2	160 - 175	20 - 30
Cakes: Victoria Sandwich	2	160 - 170	18 - 25
Cakes: Madeira	2	140 - 150	75 - 90
Cakes: Rich Fruit	2	140 - 150	120 - 150
Cakes: Gingerbread	2	140 - 150	80 - 90
Cakes: Meringues	2	90 - 100	150 - 180
Cakes: Flapjack	2	160 - 170	25 - 30
Cakes: Shortbread	2	130 - 150	45 - 60
Cakes: Apple Pie	2	170 - 180	50 - 60
Casseroles: Beef/Lamb	2	160 - 170	150 - 180
Casseroles: Chicken	2	160 - 180	80 - 90
Convenience Foods	2	Follow manufacturer's instructions	
Fish	2	170 - 190	20 - 30
Fish Pie (Potato Topped)	2	190 - 200	20 - 30
Fruit Pies, Crumbles	2	190 - 200	30 - 50

Food	Shelf Position	Temperature [°C]	Approx Cook Time (mins)
Milk Puddings	2	150 - 170	90 - 120
Pasta Lasagne etc.	2	170 - 180	40 - 50
Pastry: Choux	2	180 - 190	30 - 40
Pastry: Eclairs, Profiteroles	2	180 - 190	30 - 40
Pastry: Flaky/Puff Pies	2	210 - 220	30 - 40
Shortcrusts: Mince Pies	2	190 - 200	15 - 20
Shortcrusts: Meat Pies	2	190 - 210	25 - 35
Shortcrusts: Quiche, Tarts, Flans	2	180 - 200	25 - 50
Scones	3	220 - 230	8 - 12
Shepard's Pie	2	190 - 200	30 - 40
Souffles	2	170 - 180	20 - 30
Vegetables: Baked Jacket Potatos	2	180 - 190	60 - 90
Vegetables: Roast Potatos	2	180 - 190	60 - 90
Yorkshire Pudding Large	2	220 - 210	25 - 40
Yorkshire Pudding Individual	2	210 - 220	15 - 25
Roasting Meat, Poultry	2	See roasting chart	

## Main Oven

 Shelf Positions are not critical but ensure that oven shelves are evenly spaced

when more than one is used (e.g. shelf positions 1 and 3)

## Baking

Food	Temperature [°C]	Approx Cook Time (mins)	Shelf Position
Biscuits	180 - 190	10 - 20	1 / 3
Bread	190 - 210	30 - 35	2
Cakes: Small & Queen	150 - 170	18 - 25	1 / 3
Cakes: Sponges	160 - 170	20 - 25	3
Cakes: Madeira	140 - 160	60 - 80	3
Cakes: Rich Fruit	130 - 140	120 - 150	3
Cakes: Christmas	130 - 140	180 - 270	3
Cakes: Apple Pie	160 - 170	50 - 60	3
- Shortbread	130 - 150	45 - 60	1 / 3

Food	Temperature [°C]	Approx Cook Time (mins)	Shelf Position
Fish	160 - 180	30 - 40	3
Fruit Pies, Crumbles	170 - 180	30 - 50	3
Milk Puddings	140 - 160	60 - 90	3
Pastry: Choux	180 - 190	30 - 40	3
Pastry: Shortcrust	180 - 190	25 - 35	3
Pastry: Flaky	180 - 190	30 - 40	3
Pastry: Puff	Follow manufacturer's instructions. Reduce the temperature for Fan oven by 20°C		3
Plate Tarts	180 - 190	25 - 45	3
Quiches/Flans	170 - 180	25 - 45	3
Scones	210 - 230	8 - 12	1 / 3
Roasting: Meat, Poultry	160 - 180	see Roasting Chart	2

## Roasting

### Roasting dishes

- Use heat-resistant ovenware to roast (please read the instructions of the manufacturer).
- Large roasting joints can be roasted directly in the deep roasting pan or on the oven

shelf above the deep roasting pan. (If present)

- Roast lean meats in a roasting tin with a lid. This will keep the meat more succulent.
- All types of meat, that can be browned or have crackling, can be roasted in the roasting tin without the lid.

### Thermaflow or Conventional Cooking (if available)

## Roasting

Meat	Temperature [°C]	Cooking Time
Beef/Beef boned	170 - 190	20-35 minutes per 0.5 kb (1 lb) and 20-30 minutes over
Mutton/Lamb	170 - 190	20-35 minutes per 0.5 kb (1 lb) and 25-35 minutes over
Pork/Veal/Ham	170 - 190	30-40 minutes per 0.5 kb (1 lb) and 30-40 minutes over
Chicken	180 - 200	20-25 minutes per 0.5 kb (1 lb) and 20 minutes over
Turkey/Goose	170 - 190	15-20 minutes per 0.5 kg (1 lb) up to 3.5 kg (7 lb) then 10 minutes per 0.5 kg (1 lb) over 3.5 kg (7 lb)
Duck	180 - 200	25-35 minutes per 0.5 kb (1 lb) and 25-30 minutes over
Pheasant	170 - 190	35-40 minutes per 0.5 kb (1 lb) and 35-40 minutes over

Meat	Temperature [°C]	Cooking Time
Rabbit	170 - 190	20 minutes per 0.5 kb (1 lb) and 20 minutes over

## Grilling

**Always use the grilling function with maximum temperature setting**

**Important!** Always grill with the oven door closed

 Always pre-heat the empty oven with the grill functions for 5 minutes.

- Set the grilling set in the shelf level as recommended in the grilling table.
- Grill only flat pieces of meat or fish.

### Top Oven - Dual Circuit Grill

 Adjust shelf position and grilling set to suit different thicknesses of food.

## Grilling

Food	Shelf Position	Grill Time (min)
Bacon Rashers	3	5 - 6
Beefburgers	3	10 - 20
Chicken Joints	2	20 - 40
Chops - Lamb	2 - 3	15 - 25
Chops - Pork	2 - 3	20 - 25
Fish - Whole/Trout/Makarel	2	10 - 12
Fillets - Plaice/Cod	2	4 - 6
Kebabs	2 - 3	12 - 18
Kidneys - Lamb/Pig	2 - 3	6 - 10
Sausages	3	20 - 30
Steaks: Rare	3	4 - 6
Steaks: Medium	3	6 - 8
Steaks: Well Done	3	12 - 15
Toasted Sandwiches	3	3 - 4

## Defrosting

- Put the food out of the packaging and set it on a plate on the oven shelf.
- Do not cover with a plate or bowl. This can extend the time to defrost very much.

- Put the oven shelf in the first shelf level from the bottom.

## Oven - Care and cleaning

 **Warning!** Refer to the Safety chapters.

- Clean the front of the appliance with a soft cloth with warm water and cleaning agent.

- To clean metal surfaces use a usual cleaning agent
- Clean the oven interior after each use. Thus you can remove dirt more easily and it does not burn on.



- Clean stubborn dirt with a special oven cleaner.
- Clean all oven accessories (with a soft cloth with warm water and cleaning agent) after each use and let them dry.
- If you have nonstick accessories, do not clean them using an aggressive agents, sharp edged objects or dishwasher. It can destroy nonstick coating!

**i** **Stainless steel or aluminium appliances:**

Clean the oven door with a wet sponge only. Dry it with a soft cloth. Do not use steel wool, acids or abrasive materials as they can damage the oven surface. Clean the oven control panel with the same precautions

**Catalytic walls - main oven**

The main oven walls with a catalytic coating are self-cleaning. They absorb fat which collects on walls while the oven operates.

**To support this self-cleaning process heat the oven without any food regularly:**

1. Open the oven door.
2. Remove all accessories from the oven.
3. Close the door.
4. Set the maximum oven temperature and let the oven operate for 1 hour.
5. Clean the oven cavity with a soft and damp sponge.

**!** **Caution!** Do not attempt to clean catalytic surfaces with oven sprays, abrasive cleaners, soap or other cleaning agents. This may damage the catalytic surface.

**i** Discolouration of the catalytic surface has no effect on catalytic properties.

**Cleaning the top oven glass panels**

**i** The door glass on your product can be different in type and shape from what you see in diagrams. The number of glasses can be different.

**Removing the glass:**

1. Open the door.

2. Push the door trim at both sides to release the clips. Refer to the picture.
3. Remove the glass panels.

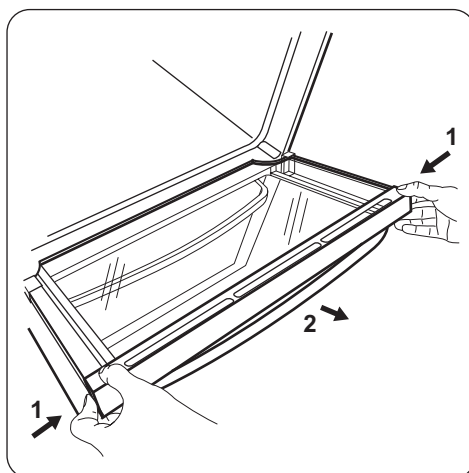

**i** To replace the glass obey the procedure in opposite sequence.

**Cleaning the oven door**

**i** The door glass on your product can be different in type and shape from what you see in diagrams. The number of glasses can be different.

**Removing the glass:**

1. Push the door trim at one side to remove it. Refer to the picture.
2. Pull up the trim.
3. Remove the glass panels.

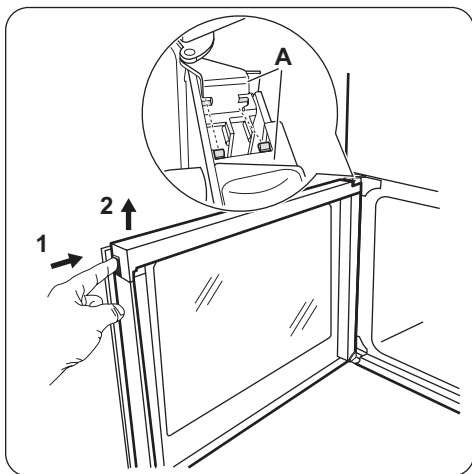

**i** To replace the glass panels obey the procedure in opposite sequence. Before you lower the trim attach the A trim part to the door. Refer to picture.

### Oven lamp

**!** **Warning!** There is a danger of electrical shock!

## What to do if...

**!** **Warning!** Refer to the Safety chapters.

Problem	Possible cause	Remedy
The hob does not operate	The heat setting is not set	Set the heat setting
The oven does not heat up	The oven is not switched on	Switch on the oven
The oven does not heat up	The clock is not set	Set the clock
The oven does not heat up	The necessary settings are not set	Control the settings
The oven does not heat up	The fuse in the fuse box is released	Control the fuse. If the fuse is released more than one time, refer to a qualified electrician.
The oven lamp does not operate	The oven lamp is defective	Replace the oven lamp
Steam and condensation settle on the food and in the oven cavity	You left the dish in the oven for too long	Do not leave the dishes in the oven for longer than 15-20 minutes after the cooking process ends
The display shows "12.00"	A power cut	Reset the clock

### Before you change the oven lamp:

- Switch off the oven.
- Remove the fuses in the fuse box or switch off the circuit breaker.

**i** Put a cloth on the bottom of the oven for protection of the oven light and glass cover.

### Replacing the oven lamp

1. You can find the lamp glass cover at the back of the cavity. Turn the lamp glass cover counterclockwise to remove it.
2. Clean the glass cover.
3. Replace the oven lamp with applicable 300°C heat-resistant oven lamp.

**Important!** Use the same oven lamp type.

4. Install the glass cover.

Problem	Possible cause	Remedy
The residual heat indicator does not come on	The cooking zone is not hot because it operated only for a short time.	If the cooking zone must be hot, speak to the Service Centre.

If you cannot find a solution to the problem yourself, contact your dealer or the service centre.

The necessary data for the service centre is on the rating plate. The rating plate is on the front frame of the oven cavity.

We recommend that you write the data here:

Model (MOD.)

.....

Product number (PNC)

.....

Serial number (S.N.)

.....

## Installation

**Warning!** Refer to the Safety chapters.

### Technical data

Dimensions	
Height	894-912 mm
Width	550 mm
Depth	600 mm
Top oven capacity	37 l
Main oven capacity	74 l

### Location of the appliance

You can install your freestanding appliance with cabinets on one or two sides and in the corner.

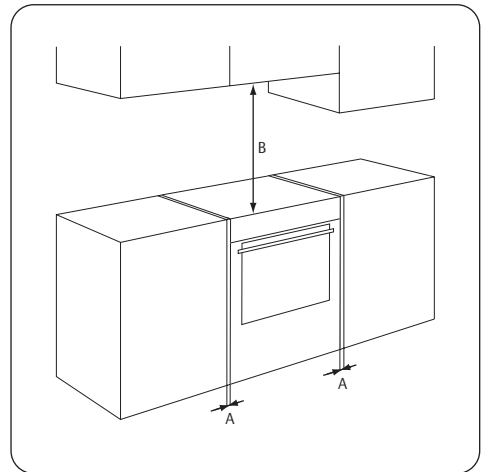

### Minimum distances

Dimension	mm
A	2
B	685

### Levelling

Use small feet on the bottom of appliance to set same level of cooker top surface with other surfaces

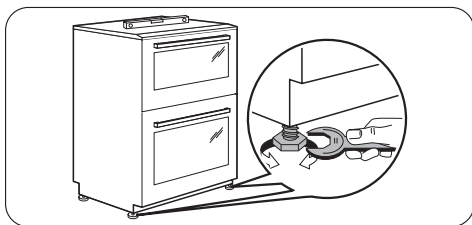

## Electrical installation

**Warning!** Only a qualified and competent person must do the electrical installation.

**i** The manufacturer is not responsible if you do not follow safety precautions from the chapter "Safety information".

This appliance is supplied without a main plug or a main cable.

## Covering terminal board

The recommended cross-section area is six square millimetres (6 mm<sup>2</sup>).

When you refit the mains terminal cover, make sure that the lower tabs are located inside the bottom edge of the aperture, before you fix the two screws into the top edge of the mains terminal cover.

## Environment concerns

Recycle the materials with the symbol ♻️. Put the packaging in applicable containers to recycle it.

Help protect the environment and human health and to recycle waste of electrical and electronic appliances. Do not dispose appliances marked with the symbol  with the household waste. Return the product to your local recycling facility or contact your municipal office.

## GREAT BRITAIN & IRELAND - Guarantee/Customer Service

### Standard guarantee conditions:

We, Electrolux, undertake that if within 12 months of the date of the purchase this Elec-

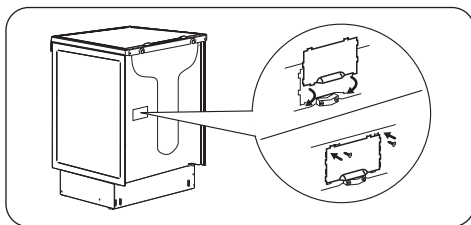

Make sure that the cover is securely fastened.

**i** To open the cover of terminal board obey the procedure in opposite sequence.

## Terminal board

Make sure that the links are fitted as shown.

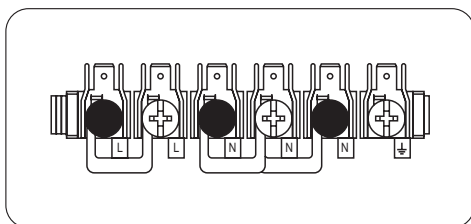

**i** Do not remove blanking plates.

**Warning!** Refer to the Safety chapters.

 Packaging material

The packaging material is environmentally-friendly and recyclable. Plastic parts are marked with international abbreviations such as PE, PS, etc. Dispose of the packaging material in the containers provided for this purpose at your local waste management facility.

trolux appliance or any part thereof is proved to be defective by reason only of faulty workmanship or materials, we will, at our option repair or replace the same FREE OF CHARGE

[www.zanussi.com](http://www.zanussi.com)

for labour, materials or carriage on condition that:

- Appliance has been correctly installed and used only on the electricity supply stated on the rating plate.
- Appliance has been used for normal domestic purposes only, in accordance with manufacturer's instructions.
- Appliance hasn't been serviced, maintained, repaired, taken apart or tampered with by person not authorised by us.
- Electrolux Service Force Centre must undertake all service work under this guarantee
- Any appliance or defective part replaced shall become the Company's property.
- This guarantee is in addition to your statutory and other legal rights.

### Exclusions

- Damage, calls resulting from transport, improper use, neglect, light bulbs, removable parts of glass, plastic.
- Costs for calls to put right appliance which is improperly installed, calls to appliances outside United Kingdom.
- Appliances found to be in use within a commercial environment, plus those which are subject to rental agreements.
- Products of Electrolux manufacturer that are not marketed by Electrolux

**Service and Spare Parts.**Please contact your local Service Force Centre: **08445 616 616**(Call will be routed to Service Force Centre covering your postcode area). For address

## European Guarantee

**GB** This appliance is guaranteed by Electrolux in each of the countries listed at the back of this user manual, for the period specified in the appliance guarantee or otherwise by law. If you move from one of these countries to another of the countries listed, the appliance guarantee will move with you subject to the following qualifications:-

of local Service Force Centre and further information, please visit: **www.service-force.co.uk** Before calling out an engineer, please ensure you have read the details under the heading "What to do if... / Troubleshooting". When you contact the Service Force Centre you will need to give the following details: Your name, address and postcode, your telephone number, clear concise details of the fault, model and serial number of the appliance (found on the rating plate), the purchase date. Please note a valid purchase receipt or guarantee documentation is required for in guarantee service calls.

**Customer Care.**Please contact our Customer Care Department: Electrolux Major Appliances, Addington Way, Luton, Bedfordshire, LU4 9QQ or visit our website at [www.electrolux.co.uk](http://www.electrolux.co.uk)

Customer Care Department,	Tel: (Calls may be recorded for training purposes)
Electrolux	08445 613 613
AEG-Electrolux	08445 611 611
Zanussi-Electrolux	08445 612 612

**For Customer Service in The Republic of Ireland please contact us at the address below:**

Electrolux Group (Irl) Ltd, Long Mile Road, Dublin 12, Republic of Ireland  
Tel: +353 (0)1 4090751, Email: [service.eid@electrolux.ie](mailto:service.eid@electrolux.ie)

- The appliance guarantee starts from the date you first purchased the appliance which will be evidenced by production of a valid purchase document issued by the seller of the appliance.
- The appliance guarantee is for the same period and to the same extent for labour and parts as exists in your new country of resi-

dence for this particular model or range of appliances.

- The appliance guarantee is personal to the original purchaser of the appliance and cannot be transferred to another user.
- The appliance is installed and used in accordance with instructions issued by Electrolux and is only used within the home, i.e. is not used for commercial purposes.

- The appliance is installed in accordance with all relevant regulations in force within your new country of residence.

The provisions of this European Guarantee do not affect any of the rights granted to you by law.

## www.electrolux.com

		
Albania	+355 4 261 450	Rruga "Kavajës", ish-parku autobuzëve, Tiranë
Belgique/België/Belgien	+32 2 7162444	Raketstraat 40, 1130 Brussel/Bruxelles
Česká Republika	+420 261 302 261	Budějovická 3, Praha 4, 140 21
Danmark	+45 70 11 74 00	Strevelinsvej 38-40, 7000 Fredericia
Deutschland	+49 180 32 26 622	Fürther Str. 246, 90429 Nürnberg
Eesti	+37 2 66 50 030	Pärnu mnt. 153, 11624 Tallinn
España	+34 902 11 63 88	Carretera M-300, Km. 29,900 Alcalá de Henares Madrid
France	08 92 68 24 33 (0.34€/min)	www.electrolux.fr
Great Britain	+44 8445 616 616	Addington Way, Luton, Bedfordshire LU4 9QQ
Hellas	+30 23 10 56 19 70	4, Limnou Str., 54627 Thessaloniki
Hrvatska	+385 1 63 23 338	Slavonska avenija 3, 10000 Zagreb
Ireland	+353 1 40 90 753	Long Mile Road Dublin 12
Italia	+39 (0) 434 558500	Corso Lino Zanussi, 30 - 33080 Porcia (PN)
Latvija	+371 67313626	Kr. Barona iela 130/2, LV-1012, Riga
Lietuva	+370 5 278 06 03	Ozo 10a, LT-08200 Vilnius
Luxembourg	+352 42 431 301	Rue de Bitbourg, 7, L-1273 Hamm
Magyarország	(06-1)467-3205 +361 252 1773	H-1142 Budapest XIV, Erzsébet Királyné útja 87
Nederland	+31 17 24 68 300	Vennootsweg 1, 2404 CG - Alphen aan den Rijn
Norge	+47 81 5 30 222	Risløkkvn. 2 , 0508 Oslo
Österreich	0810 955030	Herziggasse 9, 1230 Wien
Polska	+48 22 43 47 300	ul. Kolejowa 5/7, 01-217 Warszawa

		
Portugal	+35 12 14 40 39 39	Quinta da Fonte - Edifício Gonçalves Zarco - Q 35 -2774-518 Paço de Arcos
Romania	+40 21 451 20 30	Str. Garii Progresului 2, S4, 040671 RO
Schweiz - Suisse - Svizzera	0848 848 111	Industriestrasse 10, CH-5506 Mägenwil
Slovenija	+38 61 24 25 731	Gerbičeva ulica 110, 1000 Ljubljana
Slovensko	+421 2 32 14 13 34-5	Electrolux Slovakia s.r.o., Electrolux Domáce spotrebiče SK, Galvaniho 17/B, 821 04 Bratislava
Suomi	030 600 5200 Lankapuhelinverkosta 0,0828€/puhelu+0,032€/min Matkapuhelinverkosta 0,192€/min	
Sverige	+46 (0)771 76 76 76	Electrolux Service, S:t Göransgatan 143, S-105 45 Stockholm
Türkiye	+90 21 22 93 10 25	Tarlabası caddesi no : 35 Taksim İstanbul
Россия	8-800-200-3589	129090 Москва, Олимпийский проспект, 16, БЦ "Олимпик"
Україна	+380 44 586 20 60	04074 Київ, вул.Автозаводська, 2а, БЦ "Алкон"



[www.zanussi.com/shop](http://www.zanussi.com/shop)



892957524-A-342013



## Free Manuals Download Website

<http://myh66.com>

<http://usermanuals.us>

<http://www.somanuals.com>

<http://www.4manuals.cc>

<http://www.manual-lib.com>

<http://www.404manual.com>

<http://www.luxmanual.com>

<http://aubethermostatmanual.com>

Golf course search by state

<http://golfingnear.com>

Email search by domain

<http://emailbydomain.com>

Auto manuals search

<http://auto.somanuals.com>

TV manuals search

<http://tv.somanuals.com>