

User Manual

GETTING STARTED? EASY.



ZCV69360WA
ZCV69360BA
ZCV69360XA

EN User Manual
Cooker

ZANUSSI

VISIT OUR WEBSITE TO:



Get usage advice, brochures, trouble shooter, service and repair information:
www.zanussi.com/support

SAFETY INFORMATION

Before the installation and use of the appliance, carefully read the supplied instructions. The manufacturer is not responsible for any injuries or damage that are the result of incorrect installation or usage. Always keep the instructions in a safe and accessible location for future reference.

CHILDREN AND VULNERABLE PEOPLE SAFETY

- This appliance can be used by children aged from 8 years and above and persons with reduced physical, sensory or mental capabilities or lack of experience and knowledge if they have been given supervision or instruction concerning the use of the appliance in a safe way and understand the hazards involved. Children of less than 8 years of age and persons with very extensive and complex disabilities shall be kept away from the appliance unless continuously supervised.
- Children should be supervised to ensure that they do not play with the appliance.
- Keep all packaging away from children and dispose of it appropriately.
- **WARNING:** Keep children and pets away from the appliance when it operates or when it cools down. Accessible parts become hot during use.
- Children shall not carry out cleaning and user maintenance of the appliance without supervision.

GENERAL SAFETY

- Only a qualified person must install this appliance and replace the cable.
- This appliance must be connected to the mains with a H05VV-F type cable to withstand the temperature of the rear panel.

- This appliance is intended for use up to an altitude of 2000 m above sea level.
- This appliance is not intended to be used on ships, boats or vessels.
- Do not install the appliance behind a decorative door in order to avoid overheating.
- Do not install the appliance on a platform.
- Do not operate the appliance by means of an external timer or separate remote-control system.
- **WARNING:** Unattended cooking on a hob with fat or oil can be dangerous and may result in fire.
- **NEVER** try to extinguish a fire with water, but switch off the appliance and then cover flame e.g. with a lid or a fire blanket.
- **CAUTION:** The cooking process has to be supervised. A short term cooking process has to be supervised continuously.
- **WARNING:** Danger of fire: Do not store items on the cooking surfaces.
- Do not use a steam cleaner to clean the appliance.
- Do not use harsh abrasive cleaners or sharp metal scrapers to clean the glass door or the glass of hinged lids of the hob since they can scratch the surface, which may result in shattering of the glass.
- Metallic objects such as knives, forks, spoons and lids should not be placed on the hob surface since they can get hot.
- If the glass ceramic surface / glass surface is cracked, switch off the appliance and unplug it from the mains. In case the appliance is connected to the mains directly using junction box, remove the fuse to disconnect the appliance from power supply. In either case contact the Authorised Service Centre.
- **WARNING:** The appliance and its accessible parts become hot during use. Care should be taken to avoid touching heating elements.
- Always use oven gloves to remove or put in accessories or ovenware.
- Before maintenance, cut the power supply.
- **WARNING:** Ensure that the appliance is switched off before replacing the lamp to avoid the possibility of electric shock.

- If the mains power supply cable is damaged, it must be replaced by the manufacturer, its Authorised Service Centre or similarly qualified persons to avoid an electrical hazard.
- To remove the shelf supports first pull the front of the shelf support and then the rear end away from the side walls. Install the shelf supports in the opposite sequence.
- The means for disconnection must be incorporated in the fixed wiring in accordance with the wiring rules.
- **WARNING:** Use only hob guards designed by the manufacturer of the cooking appliance or indicated by the manufacturer of the appliance in the instructions for use as suitable or hob guards incorporated in the appliance. The use of inappropriate guards can cause accidents.

SAFETY INSTRUCTIONS

INSTALLATION



WARNING! Only a qualified person must install this appliance.

- Remove all the packaging.
- Do not install or use a damaged appliance.
- Follow the installation instructions supplied with the appliance.
- Always take care when moving the appliance as it is heavy. Always use safety gloves and enclosed footwear.
- Do not pull the appliance by the handle.
- The kitchen cabinet and the recess must have suitable dimensions.
- Keep the minimum distance from other appliances and units.
- Install the appliance in a safe and suitable place that meets installation requirements.
- Parts of the appliance carry current. Close the appliance with furniture to prevent touching the dangerous parts.
- The sides of the appliance must stay next to appliances or units with the same height.
- Do not install the appliance adjacent to a door or under a window. This prevents hot cookware to fall from the appliance when the door or the window is opened.
- Make sure to install a stabilizing means in order to prevent tipping of the appliance. Refer to Installation chapter.

ELECTRICAL CONNECTION



WARNING! Risk of fire and electric shock.

- All electrical connections should be made by a qualified electrician.
- The appliance must be earthed.
- Make sure that the parameters on the rating plate are compatible with the electrical ratings of the mains power supply.
- Always use a correctly installed shockproof socket.
- Do not use multi-plug adapters and extension cables.
- Do not let mains cables touch or come near the appliance door or the niche below the appliance, especially when it operates or the door is hot.
- The shock protection of live and insulated parts must be fastened in such a way that it cannot be removed without tools.
- Connect the mains plug to the mains socket only at the end of the installation. Make sure that there is access to the mains plug after the installation.
- If the mains socket is loose, do not connect the mains plug.
- Do not pull the mains cable to disconnect the appliance. Always pull the mains plug.
- Use only correct isolation devices: line protecting cut-outs, fuses (screw type fuses removed from the holder), earth leakage trips and contactors.

- The electrical installation must have an isolation device which lets you disconnect the appliance from the mains at all poles. The isolation device must have a contact opening width of minimum 3 mm.
- Fully close the appliance door before you connect the mains plug to the mains socket.

USE



WARNING! Risk of injury and burns.
Risk of electrical shock.

- This appliance is for household (indoors) use only.
- Do not change the specification of this appliance.
- Make sure that the ventilation openings are not blocked.
- Do not let the appliance stay unattended during operation.
- Deactivate the appliance after each use.
- Be careful when you open the appliance door while the appliance is in operation. Hot air can release.
- Do not operate the appliance with wet hands or when it has contact with water.
- Do not use the appliance as a work surface or as a storage surface.



WARNING! Risk of fire and explosion

- Fats and oil when heated can release flammable vapours. Keep flames or heated objects away from fats and oils when you cook with them.
- The vapours that very hot oil releases can cause spontaneous combustion.
- Used oil, that can contain food remnants, can cause fire at a lower temperature than oil used for the first time.
- Do not put flammable products or items that are wet with flammable products in, near or on the appliance.
- Do not let sparks or open flames to come in contact with the appliance when you open the door.
- Open the appliance door carefully. The use of ingredients with alcohol can cause a mixture of alcohol and air.



WARNING! Risk of damage to the appliance.

- To prevent damage or discoloration to the enamel:
 - do not put ovenware or other objects in the appliance directly on the bottom.

- do not put aluminium foil on the appliance or directly on the bottom of cavity.
- do not put water directly into the hot appliance.
- do not keep moist dishes and food in the appliance after you finish the cooking.
- be careful when you remove or install the accessories.

- Discoloration of the enamel or stainless steel has no effect on the performance of the appliance.
- Use a deep pan for moist cakes. Fruit juices cause stains that can be permanent.
- Do not keep hot cookware on the control panel.
- Do not let cookware boil dry.
- Be careful not to let objects or cookware fall on the appliance. The surface can be damaged.
- Do not activate the cooking zones with empty cookware or without cookware.
- Cookware made of cast iron, aluminium or with a damaged bottom can cause scratches. Always lift these objects up when you have to move them on the cooking surface.
- This appliance is for cooking purposes only. It must not be used for other purposes, for example room heating.

CARE AND CLEANING



WARNING! Risk of injury, fire, or damage to the appliance.

- Before maintenance, deactivate the appliance. Disconnect the mains plug from the mains socket.
- Make sure the appliance is cold. There is the risk that the glass panels can break.
- Replace immediately the door glass panels when they are damaged. Contact the Authorised Service Centre.
- Be careful when you remove the door from the appliance. The door is heavy!
- Fat and food remaining in the appliance can cause fire.
- Clean regularly the appliance to prevent the deterioration of the surface material.
- Make sure the cavity and the door are wiped dry after each use. Steam produced during the operation of the appliance condensates on cavity walls and can cause corrosion. To decrease the condensation operate the appliance for 10 minutes before cooking.
- Clean the appliance with a moist soft cloth. Use only neutral detergents. Do not use abrasive products, abrasive cleaning pads, solvents or metal objects.
- If you use an oven spray, follow the safety instructions on the packaging.

- Do not clean the catalytic enamel (if applicable) with any kind of detergent.

INTERNAL LIGHTING



WARNING! Risk of electric shock.

- Concerning the lamp(s) inside this product and spare part lamps sold separately: These lamps are intended to withstand extreme physical conditions in household appliances, such as temperature, vibration, humidity, or are intended to signal information about the operational status of the appliance. They are not intended to be used in other applications and are not suitable for household room illumination.
- This product contains a light source of energy efficiency class G.
- Use only lamps with the same specifications.

INSTALLATION



WARNING! Refer to Safety chapters.

TECHNICAL DATA

Dimensions

Height	894 - 912 mm
Width	600 mm
Depth	600 mm

LOCATION OF THE APPLIANCE

You can install your freestanding appliance with cabinets on one or two sides and in the corner.

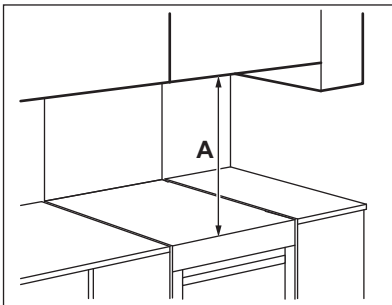

SERVICE

- To repair the appliance contact the Authorised Service Centre.
- Use original spare parts only.

DISPOSAL



WARNING! Risk of injury or suffocation.

- Contact your municipal authority for information on how to dispose of the appliance.
- Disconnect the appliance from the mains supply.
- Cut off the mains electrical cable close to the appliance and dispose of it.
- Remove the door catch to prevent children or pets from becoming trapped in the appliance.

Minimum distances

Dimension	mm
A	685

LEVELLING OF THE APPLIANCE

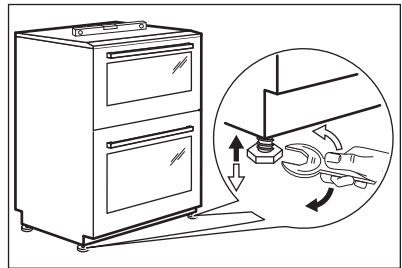

Use small feet on the bottom of appliance to set the appliance top surface level with other surfaces.

ELECTRICAL INSTALLATION



WARNING! The manufacturer is not responsible if you do not follow the safety precautions from Safety chapters.

This appliance is supplied without a main plug or a main cable.

Applicable types of cables for different phases:

Phase	Min. size cable
1	3x6.0 mm ²
3 with neutral	5x1.5 mm ²



WARNING! The power cable must not touch the part of the appliance shaded in the illustration.

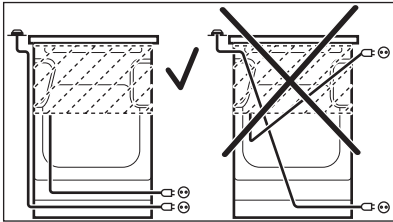

COVERING TERMINAL BOARD

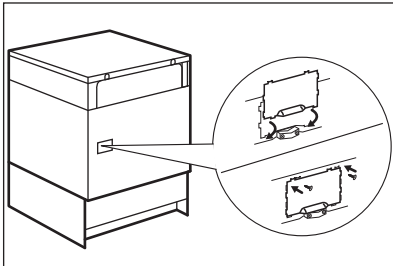

- The recommended cross-section area is six square millimetres (6 mm²).
- When you refit the mains terminal cover, make sure that the lower tabs are located inside the bottom edge of the aperture, before you fix the two screws into the top edge of the mains terminal cover.
- Make sure that the cover is securely fastened.



To open the cover of terminal board obey the procedure in opposite sequence.

TERMINAL BOARD



Do not remove blanking plates.

Make sure that the links are fitted as shown.

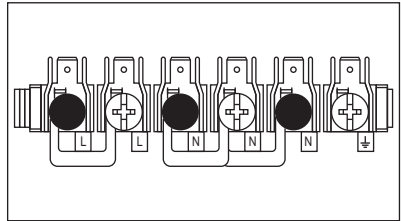

PRODUCT DESCRIPTION

GENERAL OVERVIEW

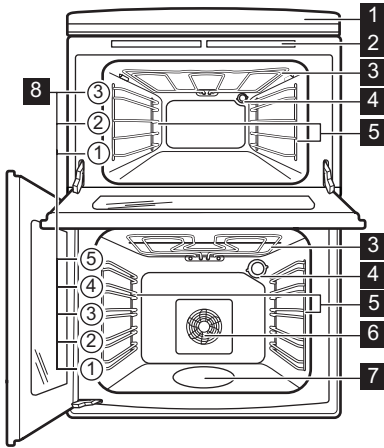

- 1 Control panel and hob
- 2 Air vents for the cooling fan
- 3 Heating element
- 4 Lamp
- 5 Shelf support, removable
- 6 Fan
- 7 Cavity embossment
- 8 Shelf positions

HOB OVERVIEW

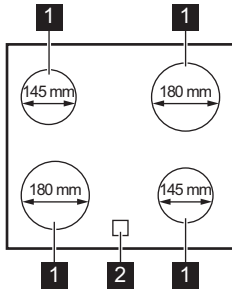

- 1 Cooking zone
- 2 Residual Heat Indicator

COOKER CONTROL PANEL

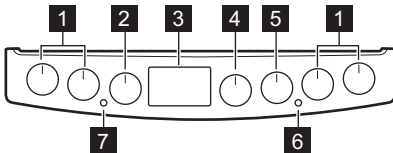

- 1 Knobs for the hob
- 2 Knob for the top oven functions
- 3 Display
- 4 Knob for the main oven functions
- 5 Knob for the main oven temperature
- 6 Temperature indicator / symbol for the main oven
- 7 Temperature indicator / symbol for the top oven

ACCESSORIES

- **Wire shelf**
For cookware, cake tins, roasts.

- **Grill- / Roasting pan**
To bake and roast or as pan to collect fat.
- **AirFry tray**

- To fry food with less oil or without baking paper.
- **Trivet**
For roasting and grilling.



Use the trivet only with the Grill- / roasting pan.

BEFORE FIRST USE

INITIAL CLEANING

Remove all accessories and removable shelf supports from the appliance.



Refer to "Care and cleaning" chapter.

Clean the appliance and the accessories before first use.

Put the accessories and the removable shelf supports back to their initial position.



SETTING THE TIME

You must set the time before you operate the oven.



Only the top oven works without the set time.

The  flashes when you connect the appliance to the electrical supply, when there was a power cut or when the timer is not set.

Press the  or  to set the correct time.

After approximately five seconds, the flashing stops and the display shows the time of day you set.

CHANGING THE TIME



You cannot change the time of day if any of the functions operates.

HOB - DAILY USE



WARNING! Refer to Safety chapters.



Use the residual heat to decrease energy consumption. Deactivate the cooking zone approximately 5 - 10 minutes before the cooking process is completed.

HEAT SETTING

Symbols	Function
0	Off position
1 - 6	Heat settings

Press  again and again until the indicator for the Time of Day function flashes.



To set a new time, refer to "Setting the time".

PREHEATING

Preheat the empty oven before first use.



Preheat the two ovens before first use. Heat up one oven at a time. Set the functions listed below, if applicable.

1. Set the function . Set the temperature to 250°C.
2. Let the oven operate for 1 hour.
3. Set the function . Set the temperature to 250°C.
4. Let the oven operate for 15 minutes.
5. Turn off the oven and let it cool down.

Accessories can become hotter than usual. The oven can emit an odour and smoke. Make sure that the airflow in the room is sufficient.

Turn the knob for the selected cooking zone to a necessary heat setting.

To complete the cooking process, turn the knob to the off position.

RESIDUAL HEAT INDICATOR



WARNING! As long as the indicator is on, there is a risk of burns from residual heat.

The indicator appears when a cooking zone is hot, but it does not function if mains power is disconnected.

The indicator may also appear:

- for the neighbouring cooking zones even if you are not using them,
- when hot cookware is placed on cold cooking zone,
- when the hob is deactivated but the cooking zone is still hot.

The indicator disappears when the cooking zone has cooled down.

HOB - HINTS AND TIPS



WARNING! Refer to Safety chapters.

COOKWARE

The cooking results depend on the cookware material

- **recommended:** aluminium, copper
- **not recommended:** stainless steel, cast iron, glass



The bottom of the cookware must be as thick and flat as possible. Ensure pan bases are clean and dry before placing on the hob surface.



Do not use cookware on the ceramic hob with bases with pronounced edges or ridges, e.g. cast iron pans. These could scratch or scour the hob surface permanently.



Cookware made of enamelled steel and with aluminium or copper bottoms can cause a colour change on the glass-ceramic surface.

To save energy and ensure that the hob operates properly the cookware bottom must have a suitable minimum diameter.

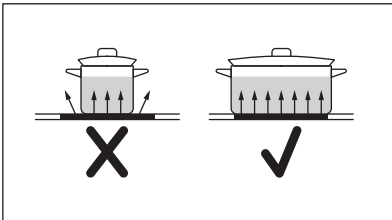

MINIMUM COOKWARE DIAMETER

Cooking zone	Cookware diameter (mm)	Power (W)
Left rear	Φ 145	1200
Right rear	Φ 180	1700
Right front	Φ 145	1200
Left front	Φ 180	1700

EXAMPLES OF COOKING APPLICATIONS

Heat setting:	Application:
1	Keeping warm
2	Gentle simmering
3	Simmering
4	Frying / browning
5	Bringing to the boil
6	Bringing to the boil / quick frying / deep-frying

HOB - CARE AND CLEANING



WARNING! Refer to Safety chapters.

GENERAL INFORMATION

- Clean the hob after each use.
- Always use cookware with a clean base.
- Scratches or dark stains on the surface have no effect on how the hob operates.
- Use a special cleaner suitable for the surface of the hob.
- Use a special scraper for the glass.

CLEANING THE HOB

- **Remove immediately:** melted plastic, plastic foil, sugar and food with sugar, otherwise, the

dirt can cause damage to the hob. Take care to avoid burns. Use a special hob scraper on the glass surface at an acute angle and move the blade on the surface.

- **Remove when the hob is sufficiently cool:** limescale rings, water rings, fat stains, shiny metallic discoloration. Clean the hob with a moist cloth and a non-abrasive detergent. After cleaning, wipe the hob dry with a soft cloth.
- **Remove shiny metallic discoloration:** use a solution of water with vinegar and clean the glass surface with a cloth.

OVEN - DAILY USE





WARNING! Refer to Safety chapters.

TOP OVEN FUNCTIONS

Symbol	Oven function	Application
0	Off position	The oven is off.
	Oven Lamp	To turn on the lamp without a cooking function.
100 - 250	Conventional Cooking	To bake and roast food on one shelf position.
	Dual Circuit Grill	To grill flat food in medium quantities in the middle of the shelf. To make toasts.
	Full Grill	To grill flat food and to toast bread.

MAIN OVEN FUNCTIONS

Symbol	Oven function	Application
0	Off position	The oven is off.

Symbol	Oven function	Application
	/AirFry Thermaflow®	/To fry food with less oil or without baking paper. For dishes like french fries or pizza. To bake on up to two shelf positions at the same time and to dry food.
	Plus Steam	To add humidity during the cooking. To get the right colour and crispy crust during baking. To give more juiciness during reheating.
	Moist Fan Baking	This function is designed to save energy during cooking. For the cooking instructions refer to "Hints and tips" chapter, Moist Fan Baking. The oven door should be closed during cooking so that the function is not interrupted and to ensure that the oven operates with the highest energy efficiency possible. When you use this function, the temperature in the cavity may differ from the set temperature. The heating power may be reduced. For general energy saving recommendations refer to "Energy Efficiency" chapter, Energy Saving. This function was used to comply with the energy efficiency class according to EN 60350-1.



You can defrost food by choosing Moist Fan Baking function without setting the temperature.



WARNING! Risk of burns and damage to the appliance.

ACTIVATING AND DEACTIVATING THE TOP / MAIN OVEN



It depends on the model if your appliance has knob symbols, indicators or lamps:

- The indicator comes on when the oven heats up.
- The lamp comes on when the oven operates.
- The symbol shows whether the knob controls one of the cooking zones, the oven functions or the temperature.

1. Turn the knob for the top / main oven functions to select an oven function.
2. Turn the knob for the temperature to select a temperature.
3. To deactivate the oven turn the knob for the top / main oven functions to the off position.

ACTIVATING THE FUNCTION: PLUS STEAM

This function increases humidity while cooking.

Released humidity can cause burns:

- Do not open the appliance door when using the function: Plus Steam.
- Open the appliance door carefully after using the function: Plus Steam.



Refer to "Hints and tips" chapter.

1. Open the oven door.
2. Fill the cavity embossment with tap water. The maximum capacity of the cavity embossment is 250 ml. Fill the cavity embossment with water only when the oven is cold.
3. Turn the function knob: Plus Steam .
4. Turn the temperature knob to set a temperature.
5. Put food in the appliance and close the oven door.



CAUTION! Do not refill the cavity embossment with water during cooking or when the oven is hot.

6. To turn off the appliance, turn the knobs for the oven functions and temperature to the off position.

7. Remove water from the cavity embossment.



WARNING! Make sure that the appliance is cold before you remove the remaining water from the cavity embossment.

COOLING FAN

When the oven operates, the cooling fan turns on automatically to keep the surfaces of the oven cool. If you turn off the oven, the cooling fan continues to operate until the oven cools down.

INSERTING THE OVEN ACCESSORIES

Deep pan:

Push the deep pan between the guide bars of the shelf support.

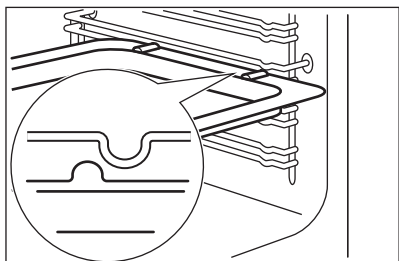

Wire shelf and the deep pan together:

Push the deep pan between the guide bars of the shelf support and the wire shelf on the guide bars above.

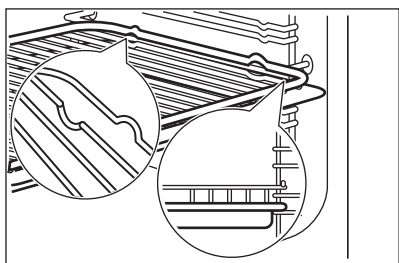

AirFry tray:

Place the AirFry tray on the third shelf position.
Place the baking tray on the first shelf position.

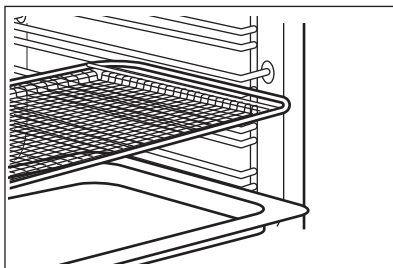

- All accessories have small indentations at the top of the right and left side to increase safety. The indentations are also anti-tip devices.
- The high rim around the shelf is a device which prevents cookware from slipping.

TRIVET AND GRILL- / ROASTING PAN

You can use the trivet to roast larger pieces of meat or poultry on one shelf position.

1. Put the trivet into the deep pan so that the supports of the wire shelf point up.

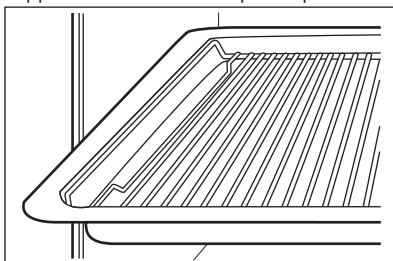

2. Put the deep pan into the oven on the necessary shelf position.

You can use the trivet to grill flat dishes in large quantities and to toast.

1. Put the trivet into the deep pan so that the supports of the wire shelf point down.

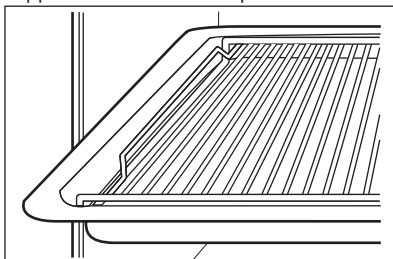

- Put the deep pan into the oven on the necessary shelf position.

OVEN - CLOCK FUNCTIONS

DISPLAY

- Clock functions
- Timer



The display works only with the main oven.

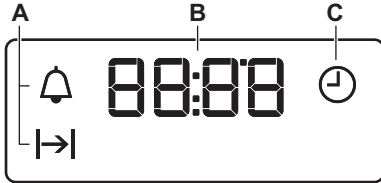

BUTTONS

Button	Function	Description
—	MINUS	To set the time.
⌚	CLOCK	To set a clock function.
+	PLUS	To set the time.

CLOCK FUNCTIONS TABLE

Clock function		Application
⌚	TIME OF DAY	To set, change or check the time of day.
→	DURATION	To set how long the appliance operates.
→	END	To set when the appliance deactivates.
→ →	TIME DELAY	To combine DURATION and END function.
🔔	MINUTE MINDER	To set countdown time. This function has no effect on the operation of the appliance. You can set the MINUTE MINDER at any time, also when the appliance is off.

SETTING THE DURATION

- Set an oven function and temperature.
- Press ⌚ again and again until |→| starts to flash.

- Press + or — to set the DURATION time.
The display shows |→|.

- When the time ends, flashes and an acoustic signal sounds. The appliance deactivates automatically.
- Press any button to stop the acoustic signal.
- Turn the knob for the oven functions and the knob for the temperature to the off position.

DURATION works only for the main oven.

SETTING THE END

- Set an oven function and temperature.
- Press again and again until starts to flash.
- Press or to set the time.

The display shows .

- When the time ends, flashes and an acoustic signal sounds. The appliance deactivates automatically.
- Press any button to stop the signal.
- Turn the knob for the oven functions and the knob for the temperature to the off position.

The function works only for the main oven.

SETTING THE TIME DELAY

- Set an oven function and temperature.
- Press again and again until starts to flash.
- Press or to set the time for DURATION.

OVEN - HINTS AND TIPS

WARNING! Refer to Safety chapters.

The temperature and baking times in the tables are guidelines only. They depend on the recipes and the quality and quantity of the ingredients used.

TOP OVEN

The top oven is smaller than the main oven. It has 3 shelf positions. Use it to cook smaller quantities of food. It is especially good for baking fruitcakes, cookies, savoury flans or quiche.

- Press .
- Press or to set the time for END.
- Press to confirm.

Appliance turns on automatically later on, works for the set DURATION time and stops at the set END time. At the set time an acoustic signal sounds.

- The appliance deactivates automatically. Press any button to stop the signal.
- Turn the knob for the oven functions and the knob for the temperature to the off position.

TIME DELAY works only for the main oven.

SETTING THE MINUTE MINDER

- Press again and again until starts to flash.
- Press or to set the necessary time. The Minute Minder starts automatically after 5 seconds.
- When the set time ends, an acoustic signal sounds. Press any button to stop the acoustic signal.
- Turn the knob for the oven functions and the knob for the temperature to the off position.

CANCELLING THE CLOCK FUNCTIONS

- Press the again and again until the necessary function indicator starts to flash.
- Press and hold .

The clock function goes out after some seconds.

MAIN OVEN

The main oven is particularly suitable for cooking larger quantities of food.

BAKING

For the first baking, use the lower temperature. You can extend the baking time by 10 – 15 minutes if you bake cakes on more than one shelf position. Cakes and pastries at different heights do not always brown equally. There is no need to change the temperature setting if an unequal browning occurs. The differences equalize during baking. Trays in the oven can distort during baking. When the trays are cold again, the distortions disappear.

TIPS ON BAKING

Baking results	Possible cause	Remedy
The bottom of the cake is not baked sufficiently.	The shelf position is incorrect.	Put the cake on a lower shelf.
The cake sinks and becomes soggy or streaky.	The oven temperature is too high.	Next time set slightly lower oven temperature.
	The oven temperature is too high and the baking time is too short.	Next time set a longer baking time and lower oven temperature.
The cake is too dry.	The oven temperature is too low.	Next time set higher oven temperature.
	The baking time is too long.	Next time set shorter baking time.
The cake bakes unevenly.	The oven temperature is too high and the baking time is too short.	Next time set a longer baking time and lower oven temperature.
	The cake batter is not evenly distributed.	Next time spread the cake batter evenly on the baking tray.
The cake is not ready in the baking time specified in a recipe.	The oven temperature is too low.	Next time set a slightly higher oven temperature.

CONVENTIONAL BAKING - TOP OVEN

Food	Temperature (°C)	Time (min)	Shelf position
Biscuits	170 - 190	10 - 20	2
Bread	200 - 220	30 - 35	2
Bread rolls / buns	200 - 220	10 - 15	2
Cakes: Victoria Sandwich	160 - 170	18 - 25	2
Cakes: Madeira	140 - 150	75 - 90	2
Cakes: Rich Fruit	140 - 150	120 - 150	2
Cakes: Gingerbread	140 - 150	80 - 90	2
Cakes: Meringues	90 - 100	150 - 180	2
Cakes: Flapjack	160 - 170	25 - 30	2
Casseroles: Beef / Lamb	160 - 170	150 - 180	2
Casseroles: Chicken	160 - 180	80 - 90	2
Convenience Foods	Follow manufacturer's instructions.		2
Fish	170 - 190	20 - 30	2

Food	Temperature (°C)	Time (min)	Shelf position
Fish Pie (Potato Topped)	190 - 200	20 - 30	2
Fruit Pies, Crumbles	190 - 200	30 - 50	2
Milk Puddings	150 - 170	90 - 120	2
Pasta Lasagne etc.	170 - 180	40 - 50	2
Pastry: Choux	180 - 190	30 - 40	2
Pastry: Eclairs, Profiteroles	180 - 190	30 - 40	2
Pastry: Flaky / Puff Pies	210 - 220	30 - 40	2
Shortcrusts: Mince Pies	190 - 200	15 - 20	2
Shortcrusts: Meat Pies	190 - 210	25 - 35	2
Shortcrusts: Quiche, Tarts, Flans	180 - 200	25 - 50	2
Scones	220 - 230	8 - 12	3
Shepard's Pie	190 - 200	30 - 40	2
Souffles	170 - 180	20 - 30	2
Vegetables: Baked Jacket Potatos	180 - 190	60 - 90	2
Vegetables: Roast Potatos	180 - 190	60 - 90	2
Yorkshire Pudding Large	220 - 210	25 - 40	2
Yorkshire Pudding Individual	210 - 220	15 - 25	2
Roasting Meat, Poultry	Refer to the Roasting table.		2

THERMAFLOW® BAKING - MAIN OVEN



Shelf positions are not critical but ensure that the oven accessories are evenly spaced when more than one is used.

Food	Temperature (°C)	Time (min)	Shelf position
Biscuits	180 - 190	10 - 20	1 - 3
Bread	190 - 210	30 - 35	2
Cakes: Small & Queen	150 - 170	18 - 25	1 - 3
Cakes: Sponges	160 - 170	20 - 25	3
Cakes: Madeira	140 - 160	60 - 80	3
Cakes: Rich Fruit	130 - 140	120 - 150	3

Food	Temperature (°C)	Time (min)	Shelf position
Cakes: Christmas	130 - 140	180 - 270	3
Cakes: Apple Pie	160 - 170	50 - 60	3
- Shortbread	130 - 150	45 - 60	1 - 3
Fish	160 - 180	30 - 40	3
Fruit Pies, Crumbles	170 - 180	30 - 50	3
Milk Puddings	140 - 160	60 - 90	3
Pastry: Choux	180 - 190	30 - 40	3
Pastry: Shortcrust	180 - 190	25 - 35	3
Pastry: Flaky	180 - 190	30 - 40	3
Pastry: Puff	Follow manufacturer's instructions. Reduce the temperature for Fan oven by 20 °C.		3
Plate Tarts	180 - 190	25 - 45	3
Quiches / Flans	170 - 180	25 - 45	3
Scones	210 - 230	8 - 12	1 - 3
Roasting: Meat, Poultry	160 - 180	Refer to the Roasting table.	2

MOIST FAN BAKING

Bread and pizza

Food	Temperature (°C)	Time (min)	Shelf position
Buns	180	25 - 35	3
Frozen pizza 350 g	190	25 - 35	3

Cakes in baking tray

Food	Temperature (°C)	Time (min)	Shelf position
Swiss roll	180	20 - 30	3
Brownie	180	30 - 40	3

Cakes in tin

Food	Temperature (°C)	Time (min)	Shelf position
Soufflé	200	30 - 40	3

Food	Temperature (°C)	Time (min)	Shelf position
Sponge flan base	180	20 - 30	3
Victoria sandwich	150	25 - 35	3

Fish

Food	Temperature (°C)	Time (min)	Shelf position
Fish in pouches 300 g	180	25 - 35	3
Whole fish 200 g	180	25 - 35	3
Fish fillet 300 g	180	25 - 35	3

Meat

Food	Temperature (°C)	Time (min)	Shelf position
Meat in pouch 250 g	200	25 - 35	3
Meat skewers 500 g	200	30 - 40	3

Small baked items

Food	Temperature (°C)	Time (min)	Shelf position
Cookies	180	25 - 35	3
Macaroons	160	25 - 35	3
Muffins	180	25 - 35	3
Savoury cracker	170	20 - 30	3
Short crust pastry biscuits	150	25 - 35	3
Tartelettes	170	15 - 25	3

Vegetarian

Food	Temperature (°C)	Time (min)	Shelf position
Mixed vegetables in pouch 400 g	180	25 - 35	3
Omelette	200	20 - 30	3
Vegetables on tray 700 g	180	25 - 35	3

Bakery

Food	Temperature (°C)	Water in the cavity embossment (ml)	Preheating time (min)	Time (min)	Shelf position
White bread	180	150	10	35 - 45	2
Bread rolls	200	150	5	20 - 25	2
Focaccia	190	150	10	20 - 25	2
Homemade pizza	230	100	10	15 - 20	2
Cookies, scones, croissant	160	150	10	10 - 20	2
Plum cake, cinnamon rolls	160	150	10	70 - 80	2

Frozen foods

Food	Temperature (°C)	Water in the cavity embossment (ml)	Preheating time (min)	Time (min)	Shelf position
Pizza	200	100	10	15 - 20	2
Croissant	160	50	10	15 - 30	2
Lasagne	200	200	10	35 - 45	2

Food regeneration

Food	Temperature (°C)	Water in the cavity embossment (ml)	Preheating time (min)	Time (min)	Shelf position
White bread	110	100	10	15 - 25	2
Bread rolls	110	100	10	10 - 20	2
Homemade pizza	110	100	10	15 - 25	2
Focaccia	110	100	10	15 - 25	2
Vegetables	110	100	10	15 - 25	2
Rice	110	100	10	15 - 25	2
Pasta	110	100	10	15 - 25	2
Meat	110	100	10	15 - 25	2

Roasting

Food	Temperature (°C)	Water in the cavity embossment (ml)	Preheating time (min)	Time (min)	Shelf position
Chicken	210	200	-	65 - 75	2
Half chicken	210	200	-	35 - 50	2
Roast pork	180	200	-	65 - 70	2
Roast beef 1 - 1,5 kg 1. Rare 2. Medium 3. Well done	200	200	-	1. 50 - 55 2. 60 - 65 3. 65 - 75	2
Roast turkey	200	200	-	70 - 85	2

TIPS ON ROASTING

Use heat-resistant ovenware.

Roast lean meat covered (you can use aluminium foil).

Roast large meat joints directly in the tray or on the wire shelf placed above the tray.

Put some water in the tray to prevent dripping fat from burning.

Turn the roast after 1/2 - 2/3 of the cooking time.

Baste meat joints with their own juice several times during roasting.

THERMAFLOW® - MAIN OVEN

Roasting

Food	Temperature (°C)	Time (min)
Beef / Beef boned	170 - 190	20 - 35 minutes per 0.5 kg (1 lb) and 20 - 30 minutes over
Mutton / Lamb	170 - 190	20 - 35 minutes per 0.5 kg (1 lb) and 25 - 35 minutes over
Pork / Veal / Ham	170 - 190	30 - 40 minutes per 0.5 kg (1 lb) and 30 - 40 minutes over
Chicken	180 - 200	20 - 25 minutes per 0.5 kg (1 lb) and 20 minutes over
Turkey / Goose	170 - 190	15 - 20 minutes per 0.5 kg (1 lb) up to 3.5 kg (7 lb) then 10 minutes per 0.5 kg (1 lb) over 3.5 kg (7 lb)
Duck	180 - 200	25 - 35 minutes per 0.5 kg (1 lb) and 25 - 30 minutes over
Pheasant	170 - 190	35 - 40 minutes per 0.5 kg (1 lb) and 35 - 40 minutes over
Rabbit	170 - 190	20 minutes per 0.5 kg (1 lb) and 20 minutes over

GRILLING IN GENERAL



WARNING! Always grill with the oven door closed.

- **Always grill with the maximum temperature setting.**
- Set the shelf into the shelf position as recommended in the grilling table.
- Always set the deep pan to collect the fat into the first shelf position.

- Grill only flat pieces of meat or fish.

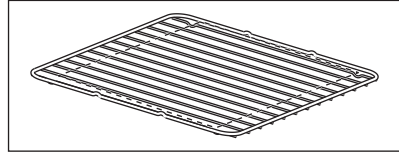

The grilling area is set in centre of the shelf.

DUAL GRILL - TOP OVEN

Food	Time (min)	Shelf position
Bacon Rashers	5 - 6	3
Chicken Joints	20 - 40	2
Chops - Lamb	15 - 25	2 - 3
Chops - Pork	20 - 25	2 - 3
Fish - Whole / Trout / Makarel	10 - 12	2
Fillets - Plaice / Cod	4 - 6	2
Kebabs	12 - 18	2 - 3
Kidneys - Lamb / Pig	6 - 10	2 - 3
Sausages	20 - 30	3
Steaks: Rare	4 - 6	3
Steaks: Medium	6 - 8	3
Steaks: Well Done	12 - 15	3

AIRFRY

Bakery products

Food	Quantity	Temperature (°C)	Time (min)	Shelf position
Croissant, frozen	approx. 350 g	180 - 220	15 - 30	3
Puff pastry, frozen	approx. 400 g	180 - 220	15 - 35	3
Puff pastry, fresh	approx. 300 g	180 - 220	15 - 35	3
Pizza, frozen	approx. 340 g	180 - 220	20 - 35	3

Potato products

Food	Quantity	Temperature (°C)	Time (min)	Shelf position
French Fries, frozen	approx. 650 g	180 - 220	20 - 30	3
French Fries thick, frozen	approx. 600 g	180 - 220	20 - 30	3
Potato wedges, frozen	approx. 650 g	180 - 220	15 - 25	3
Croquettes	approx. 450 g	180 - 220	15 - 30	3

Fresh vegetables

Food	Quantity	Temperature (°C)	Time (min)	Shelf position
Zucchini slices, fresh ¹⁾	approx. 500 g	180 - 220	25 - 35	3

1) add 1 teaspoon of olive oil to avoid sticking

Other

Food	Quantity	Temperature (°C)	Time (min)	Shelf position
Escalopes, frozen	approx. 300 g	180 - 220	15 - 25	3
Shrimps in baking dough, frozen	approx. 200 g	180 - 220	15 - 25	3
Calamari rings, frozen	approx. 250 g	180 - 220	15 - 25	3
Chicken nuggets, frozen	approx. 300 g	180 - 220	15 - 25	3
Fish fingers, frozen	approx. 500 g	180 - 220	15 - 25	3

INFORMATION FOR TEST INSTITUTES

Main oven

Food	Function	Temperature (°C)	Time (min)	Accessories	Shelf position
Small cakes (20 small cakes per tray)	Conventional Cooking	170	25 - 35	Tray	3
Small cakes (20 small cakes per tray)	Thermaflow®	150	25 - 35	Tray	3
Small cakes (20 small cakes per tray)	Thermaflow®	150	25 - 35	Tray	1 / 4

Food	Function	Temperature (°C)	Time (min)	Accessories	Shelf position
Apple pie, 2 tins (ø 20 cm) on the grid, diagonally shifted	Conventional Cooking	200	80 - 100	Grid	1
Apple pie, 2 tins (ø 20 cm) on the grid, diagonally shifted	Thermaflow®	170	80 - 100	Grid	2
Apple pie, 2 tins (ø 20 cm) on the grid, diagonally shifted ¹⁾	Plus Steam	160	70 - 80	Tray	2
Fatless sponge cake, 1 tin (ø 26 cm) on the grid	Conventional Cooking	200	25 - 35	Grid	2
Fatless sponge cake, 1 tin (ø 26 cm) on the grid	Thermaflow®	170	25 - 35	Grid	2
Fatless sponge cake, 1 tin (ø 26 cm) on the grid	Thermaflow®	170	30 - 40	Grid	1 / 4
Shortbread/Pastry strip	Conventional Cooking	160	20 - 30	Tray	3
Shortbread/Pastry strip	Thermaflow®	140	20 - 30	Tray	3
Shortbread/Pastry strip	Thermaflow®	140	15 - 25	Tray	1 / 4

1) Add 150 ml of water to the cavity embossment.

Top oven

Food	Function	Temperature (°C)	Time (min)	Accessories	Shelf position
Small cakes (20 small cakes per tray)	Conventional Cooking	150	25 - 35	Tray	2
Apple pie, 2 tins (ø 20 cm) on the grid, diagonally shifted	Conventional Cooking	170	60 - 80	Grid	1
Fatless sponge cake, 1 tin (ø 26 cm) on the grid	Conventional Cooking	170	20 - 30	Grid	2
Shortbread/Pastry strip	Conventional Cooking	140	15 - 25	Tray	2

Food	Function	Temperature (°C)	Time (min)	Accessories	Shelf position
Toast	Full Grill	-	3 - 8	Grid	2
Beef burger	Dual Circuit Grill	-	15 - 25 (first side) 10 - 20 (second side)	Grid / Roasting pan	2

OVEN - CARE AND CLEANING



WARNING! Refer to Safety chapters.

NOTES ON CLEANING



Cleaning Agents

Clean the front of the oven with a soft cloth with warm water and a mild detergent.

Use a cleaning solution to clean metal surfaces.

Clean stains with a mild detergent. Do not apply it on the catalytic surfaces.



Everyday Use

Clean the cavity after each use. Fat accumulation or other residue may cause fire.

Do not store the food in the oven for longer than 20 minutes. Dry the cavity with a soft cloth after each use.



Accessories

Clean all accessories after each use and let them dry. Use a soft cloth with warm water and a mild detergent. Do not clean the accessories in a dishwasher (except from AirFry tray).

Do not clean the non-stick accessories and AirFry tray using abrasive cleaner or sharp-edged objects.

CLEANING THE AIRFRY TRAY

1. Put the AirFry tray on the baking tray.
2. Pour hot water with detergent and let it soak.
3. Clean the AirFry tray with a sponge or use a brush to remove scraps.

Cleaning in the dishwasher is also possible.

CATALYTIC CLEANING



CAUTION! Do not clean the catalytic surface with oven sprays, soap or other cleaning agents. It will damage the catalytic surface.



CAUTION! Always turn the oven light on while using the catalytic cleaning (if applicable).



WARNING! Keep children away when you clean the oven at a high temperature. The oven surface becomes very hot and there is a risk of burns.



Spots or discolouration of the catalytic surface have no effect on catalytic properties.



Before activating the catalytic cleaning remove all the accessories from the oven.

The walls with catalytic coating are self-cleaning. They absorb fat which collects on the walls while the appliance operates.

To support the self-cleaning procedure, heat the empty oven on a regular basis.

The oven cavities must be cleaned separately.

Catalytic cleaning works only in the main oven.

1. Clean the oven floor with warm water and washing-up liquid, then dry it.
2. Set the oven temperature to 250 °C and let the oven operate for 1 hour.
3. When the appliance is cool, clean it with a soft and moist sponge.

CLEANING THE CAVITY EMBOSSEMENT

The cleaning procedure removes limestone residue from the cavity embossment after cooking with steam.



For the function: Plus Steam we recommend to do the cleaning procedure at least every 5 - 10 cooking cycles.

1. Put 250 ml of white vinegar into the cavity embossment at the bottom of the oven. Use maximum 6% vinegar without any additives.
2. Let the vinegar dissolve the residual limestone at the ambient temperature for 30 minutes.
3. Clean the cavity with warm water and a soft cloth.

REMOVING THE SHELF SUPPORTS

To clean the oven, remove the shelf supports.

1. Pull the front of the shelf support away from the side wall.

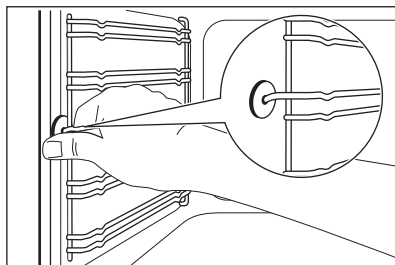

2. Pull the rear end of the shelf support away from the side wall and remove it.

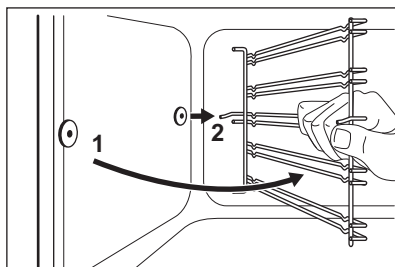

Install the shelf supports in the opposite sequence.



CAUTION! Make sure that the longer fixing wire is in the front. The ends of the two wires must point to the rear. Incorrect installation can cause damage to the enamel.

REMOVING AND CLEANING THE DOOR GLASSES - TOP OVEN



The door glass in your product can be different in type and shape from the examples you see in the image. The number of glasses can also be different.

1. Open the door.
2. Hold the door trim on the top edge of the door at the two sides and push inwards to release the clip seal.

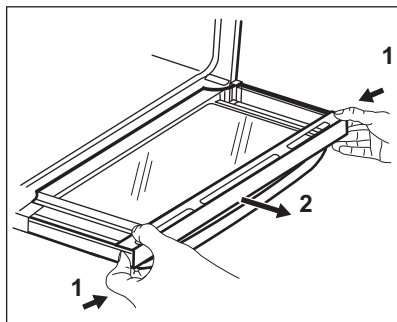

3. Pull the door trim to the front to remove it.
 4. Remove the glass panels.
- To install the panels, do the same steps in reverse.

REMOVING AND CLEANING THE DOOR GLASSES - MAIN OVEN

i The door glass in your product can be different in type and shape from the example you see in the image. The number of glasses can also be different.

1. Push the door trim at one side to remove it.

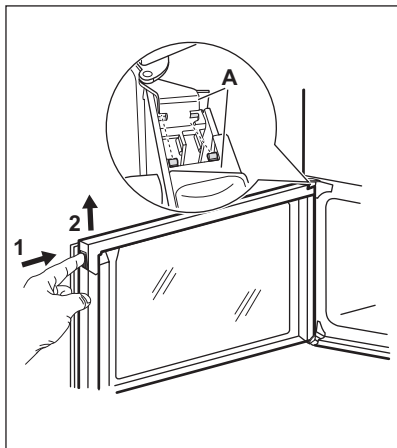

TROUBLESHOOTING



WARNING! Refer to Safety chapters.

2. Pull up the trim.
3. Remove the glass panels.



To replace the glass panels, do the same steps in reverse. Before you lower the trim, attach the A trim part to the door. Refer to the image.

REPLACING THE LAMP



WARNING! Risk of electric shock. The lamp can be hot.

1. Turn off the oven. Wait until the oven is cold.
2. Disconnect the oven from the mains.
3. Put a cloth on the bottom of the cavity.

The back lamp



The lamp glass cover is at the back of the cavity.

1. Turn the lamp glass cover counterclockwise to remove it.
2. Clean the glass cover.
3. Replace the oven lamp with a suitable 300 °C heat-resistant oven lamp. Use the same oven lamp type.
4. Install the glass cover.

WHAT TO DO IF...

Problem	Possible cause	Remedy
You cannot activate the appliance.	The appliance is not connected to an electrical supply or it is connected incorrectly.	Check if the appliance is correctly connected to the electrical supply.
You cannot activate the appliance.	The fuse is blown.	Make sure that the fuse is the cause of the malfunction. If the fuse is blown again and again, contact a qualified electrician.
Residual heat indicator does not come on.	The zone is not hot because it operated only for a short time.	If the zone operated sufficiently long to be hot, speak to an Authorised Service Centre.
The oven does not heat up.	The oven is deactivated.	Activate the oven.
The oven does not heat up.	The clock is not set.	Set the clock.
The oven does not heat up.	The necessary settings are not set.	Make sure that the settings are correct.
The lamp does not operate.	The lamp is defective.	Replace the lamp.
The display shows "12.00".	There was a power cut.	Reset the clock.
Steam and condensation settle on the food and in the cavity of the oven.	You left the dish in the oven for too long.	Do not leave the dishes in the oven for longer than 15 - 20 minutes after the cooking process ends.
There is no good cooking performance using the Plus Steam function.	You did not fill the cavity embossment with water.	Refer to "Activating the Plus Steam function".
The water in the cavity embossment does not boil.	The temperature is too low.	Set the temperature at least to 110°C. Refer to "Hints and Tips" chapter.
The water comes out of the cavity embossment.	There is too much water in the cavity embossment.	Deactivate the oven and make sure that the appliance is cold. Wipe the water with a cloth or sponge. Add the correct amount of water to the cavity embossment. Refer to "Activating the Plus Steam function".

SERVICE DATA

If you cannot find a solution to the problem yourself, contact your dealer or an Authorised Service Centre. The necessary data for the service centre is on the rating plate. The rating plate is on the front frame of the oven cavity. Do not remove the rating plate from the oven cavity.

We recommend that you write the data here:

Model (MOD.)
--------------	-------

We recommend that you write the data here:

Product number (PNC)
Serial number (S.N.)

ENERGY EFFICIENCY

PRODUCT INFORMATION FOR HOB ACCORDING TO EU 66/2014

Model identification	ZCV69360WA ZCV69360BA ZCV69360XA	
Type of hob	Hob inside Freestanding Cooker	
Number of cooking zones	4	
Heating technology	Radiant Heater	
Diameter of circular cooking zones (Ø)	Left front Left rear Right front Right rear	18.0 cm 14.5 cm 14.5 cm 18.0 cm
Energy consumption per cooking zone (EC electric cooking)	Left front Left rear Right front Right rear	177.3 Wh/kg 180.3 Wh/kg 180.3 Wh/kg 179.4 Wh/kg
Energy consumption of the hob (EC electric hob)	179.3 Wh/kg	

EN 60350-2 - Household electric cooking appliances - Part 2: Hobs - Methods for measuring performance.

HOB - ENERGY SAVING

You can save energy during everyday cooking if you follow below hints.

- When you heat up water, use only the amount you need.
- If it is possible, always put the lids on the cookware.
- Before you activate the cooking zone put the cookware on it.
- The cookware bottom should have the same diameter as the cooking zone.
- Put the smaller cookware on the smaller cooking zones.
- Put the cookware directly in the centre of the cooking zone.
- Use the residual heat to keep the food warm or to melt it.

PRODUCT INFORMATION FOR OVENS AND PRODUCT INFORMATION SHEET*

Supplier's name	Zanussi
Model identification	ZCV69360WA ZCV69360BA ZCV69360XA
Energy Efficiency Index	Top oven: 105.6 Main oven: 95.3

Energy efficiency class	Top oven: A Main oven: A	
Energy consumption with a standard load, conventional mode	Top oven: 0.75 kWh/cycle Main oven: not applicable	
Energy consumption with a standard load, fan-forced mode	Top oven: not applicable Main oven: 0.82 kWh/cycle	
Number of cavities	2	
Heat source	Electricity	
Volume	Top oven: 39 l Main oven: 73 l	
Type of oven	Oven inside Freestanding Cooker	
Mass	ZCV69360WA	59.5 kg
	ZCV69360BA	59.5 kg
	ZCV69360XA	59.5 kg

* For European Union according to EU Regulations 65/2014 and 66/2014.
For Republic of Belarus according to STB 2478-2017, Appendix G; STB 2477-2017, Annexes A and B.
For Ukraine according to 568/32020.

Energy efficiency class is not applicable for Russia.

EN 60350-1 - Household electric cooking appliances - Part 1: Ranges, ovens, steam ovens and grills
- Methods for measuring performance.

OVEN - ENERGY SAVING



The oven has features which help you save energy during everyday cooking.

Make sure that the oven door is closed when the oven operates. Do not open the oven door too often during cooking. Keep the door gasket clean and make sure it is well fixed in its position.

Use metal cookware to improve energy saving. When possible, do not preheat the oven before cooking.

Keep breaks between baking as short as possible when you prepare a few dishes at one time.

Cooking with fan

When possible, use the cooking functions with fan to save energy.

Residual heat

When the cooking duration is longer than 30 min, reduce the oven temperature to minimum 3 - 10 min before the end of cooking. The residual heat inside the oven will continue to cook.

Use the residual heat to warm up other dishes.

Keep food warm

Choose the lowest possible temperature setting to use residual heat and keep a meal warm.

Moist Fan Baking

Function designed to save energy during cooking.

ENVIRONMENTAL CONCERNS

Recycle materials with the symbol . Put the packaging in relevant containers to recycle it. Help protect the environment and human health by recycling waste of electrical and electronic

appliances. Do not dispose of appliances marked with the symbol  with the household waste. Return the product to your local recycling facility or contact your municipal office.

WWW.ZANUSSI.COM/SHOP



CE

867338808-C-372021

Free Manuals Download Website

<http://myh66.com>

<http://usermanuals.us>

<http://www.somanuals.com>

<http://www.4manuals.cc>

<http://www.manual-lib.com>

<http://www.404manual.com>

<http://www.luxmanual.com>

<http://aubethermostatmanual.com>

Golf course search by state

<http://golfingnear.com>

Email search by domain

<http://emailbydomain.com>

Auto manuals search

<http://auto.somanuals.com>

TV manuals search

<http://tv.somanuals.com>