

EN

User Manual

USER MANUAL

Fridge Freezer

ZRB38313WA

ZANUSSI

Contents

Safety information.....	2	Hints and tips.....	8
Safety instructions.....	3	Care and cleaning.....	9
Product description.....	5	Troubleshooting.....	10
Operation.....	6	Installation.....	12
Daily use.....	6	Technical information.....	13

Subject to change without notice.

Safety information

Before the installation and use of the appliance, carefully read the supplied instructions. The manufacturer is not responsible if an incorrect installation and use causes injuries and damages. Always keep the instructions with the appliance for future reference.

Children and vulnerable people safety

- This appliance can be used by children aged from 8 years and above and persons with reduced physical, sensory or mental capabilities or lack of experience and knowledge if they have been given supervision or instruction concerning use of the appliance in a safe way and understand the hazards involved.
- Do not let children play with the appliance.
- Cleaning and user maintenance shall not be made by children without supervision.
- Keep all packaging away from children.

General Safety

- This appliance is intended to be used in household and similar applications such as:
 - Farm houses; staff kitchen areas in shops, offices and other working environments
 - By clients in hotels, motels, bed and breakfast and other residential type environments
- Keep ventilation openings, in the appliance enclosure or in the built-in structure, clear of obstruction.

- Do not use mechanical devices or other means to accelerate the defrosting process, other than those recommended by the manufacturer.
- Do not damage the refrigerant circuit.
- Do not use electrical appliances inside the food storage compartments of the appliance, unless they are of the type recommended by the manufacturer.
- Do not use water spray and steam to clean the appliance.
- Clean the appliance with a moist soft cloth. Only use neutral detergents. Do not use abrasive products, abrasive cleaning pads, solvents or metal objects.
- Do not store explosive substances such as aerosol cans with a flammable propellant in this appliance.
- If the supply cord is damaged, it must be replaced by the manufacturer, its Authorised Service Centre or similarly qualified persons in order to avoid a hazard.

Safety instructions

Installation



WARNING!

Only a qualified person must install this appliance.

- Remove all the packaging.
- Do not install or use a damaged appliance.
- Obey the installation instruction supplied with the appliance.
- Always be careful when you move the appliance because it is heavy. Always wear safety gloves.
- Make sure the air can circulate around the appliance.
- Wait at least 4 hours before connecting the appliance to the power supply. This is to allow the oil to flow back in the compressor.
- Do not install the appliance close to radiators or cookers, oven or hobs.
- The rear of the appliance must stand against the wall.
- Do not install the appliance where there is direct sunlight.
- Do not install this appliance in areas that are too humid or too colds, such as the construction appendices, garages or wine cellars.

- When you move the appliance, lift it by the front edge to avoid scratching the floor.

Electrical connection



WARNING!

Risk of fire and electrical shock.

- The appliance must be earthed.
- Make sure that the electrical information on the rating plate agrees with the power supply. If not, contact an electrician.
- Always use a correctly installed shockproof socket.
- Do not use multi-plug adapters and extension cables.
- Make sure not to cause damage to the electrical components (e.g. mains plug, mains cable, compressor). Contact the Authorised Service Centre or an electrician to change the electrical components.
- The mains cable must stay below the level of the mains plug.
- Connect the mains plug to the mains socket only at the end of the installation. Make sure that there is access to the mains plug after the installation.
- Do not pull the mains cable to disconnect the appliance. Always pull the mains plug.

Use



WARNING!

Risk of injury, burns, electrical shock or fire.

- Do not change the specification of this appliance.
- Do not put electrical appliances (e.g. ice cream makers) in the appliance unless they are stated applicable by the manufacturer.
- Be careful not to cause damage to the refrigerant circuit. It contains isobutane (R600a), a natural gas with a high level of environmental compatibility. This gas is flammable.
- If damage occurs to the refrigerant circuit, make sure that there are no flames and sources of ignition in the room. Ventilate the room.
- Do not let hot items to touch the plastic parts of the appliance.
- Do not put soft drinks in the freezer compartment. This will create pressure on the drink container.
- Do not store flammable gas and liquid in the appliance.
- Do not put flammable products or items that are wet with flammable products in, near or on the appliance.
- Do not touch the compressor or the condenser. They are hot.
- Do not remove or touch items from the freezer compartment if your hands are wet or damp.
- Do not freeze again food that has been thawed.
- Obey the storage instructions on the packaging of frozen food.

Care and cleaning



WARNING!

Risk of injury or damage to the appliance.

- Before maintenance, deactivate the appliance and disconnect the mains plug from the mains socket.
- This appliance contains hydrocarbons in the cooling unit. Only a qualified person must do the maintenance and the recharging of the unit.
- Regularly examine the drain of the appliance and if necessary, clean it. If the drain is blocked, defrosted water collects in the bottom of the appliance.

Disposal



WARNING!

Risk of injury or suffocation.

- Disconnect the appliance from the mains supply.
- Cut off the mains cable and discard it.
- Remove the door to prevent children and pets to be closed inside of the appliance.
- The refrigerant circuit and the insulation materials of this appliance are ozone-friendly.
- The insulation foam contains flammable gas. Contact your municipal authority for information on how to discard the appliance correctly.
- Do not cause damage to the part of the cooling unit that is near the heat exchanger.

Product description

Product overview

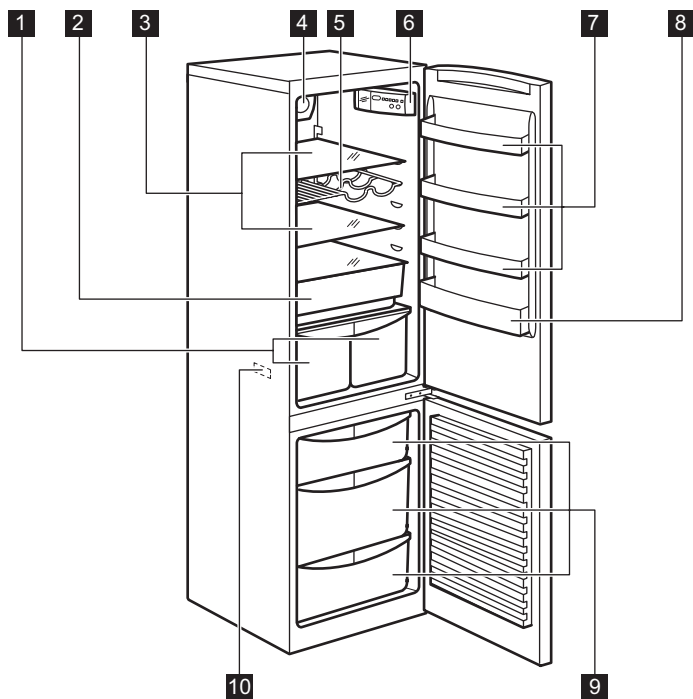

- 1** Vegetable drawers
- 2** Low temperature compartment
- 3** Cabinet shelves
- 4** Dynamic Air Cooling
- 5** Bottle rack
- 6** Control panel

- 7** Door shelves
- 8** Bottle shelf
- 9** Freezer drawers
- 10** Rating plate

Operation

Control panel

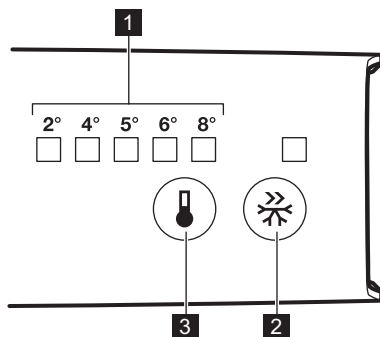

- 1 Temperature indicators LED
- 2 QuickFreeze button
- 3 Temperature regulator

Switching on

Insert the plug into the wall socket.

QuickFreeze function

You can activate the QuickFreeze function by pressing the QuickFreeze button.

The LED corresponding to the symbol QuickFreeze indicator lights up.

You can deactivate the QuickFreeze function by pressing the QuickFreeze button again.

The QuickFreeze indicator will light off.

i This function stops automatically after 52 hours.

Temperature regulation

To operate the appliance, touch the temperature regulator button until the LED corresponding to the required temperature

lights up. Selection is progressive, varying from 2 to 8°C.

At first button touch actual setting LED keeps blinking.

Any time the button is touch the set temperature is moved to 1 position .

Corresponding LED will blink for a while.

Touch the setting button until the required temperature is selected. The set will be fixed

i Coldest setting: +2°C.
Warmest setting: +8°C.
A medium setting is generally the most suitable.

However, the exact setting should be chosen keeping in mind that the temperature inside the appliance depends on:

- room temperature
- how often the door is opened
- quantity of food stored
- appliance location.

Daily use



WARNING!

Refer to Safety chapters.

Initial power on



CAUTION!

Before inserting the power plug in to the outlet and switching on the cabinet for the first time, leave the appliance standing upright for at least 4 hours. This will assure a sufficient amount of time for the oil to return to the compressor. Otherwise the compressor or electronic components may sustain damage.

Storage of frozen food

When first starting-up or after a period out of use, before putting the products in the compartment let the appliance run at least 2 hours with the QuickFreeze function turned on.

If large quantities of food are to be stored, remove all drawers from appliance and place food on glass shelf to obtain the best performance.



In the event of accidental defrosting, for example due to a power failure, if the power has been off for longer than the value shown in the technical data chart under "Rising time", the defrosted food must be consumed quickly or cooked immediately and then re-frozen (after cooling).

Freezing fresh food

The freezer compartment is suitable for freezing fresh food and storing frozen and deep-frozen food for a long time.

To freeze small amount of fresh foods it is not necessary to change the present setting.

To freeze fresh food activate the QuickFreeze function at least 24 hours before placing the food to be frozen in the freezer compartment.

Place the fresh food to be frozen in the third compartment.

The maximum amount of food that can be frozen in 24 hours is specified on the **rating plate**, a label located on the inside of the appliance.

The freezing process lasts 24 hours: during this period do not add other food to be frozen.

When the freezing process is completed, return to the required temperature (see "QuickFreeze Function").



In this condition, the refrigerator compartment temperature might drop below 0°C. If this occurs reset the temperature regulator to a warmer setting.

Thawing

Deep-frozen or frozen food, prior to being used, can be thawed in the refrigerator compartment or at room temperature, depending on the time available for this operation.

Small pieces may even be cooked still frozen, directly from the freezer: in this case, cooking will take longer.

Dynamic air cooling

This device allows for rapid cooling of foods and a more uniform temperature in the refrigerator compartment.

To activate, press the switch (A) to turn on the fan. A green light comes on.

If the requested temperature is reached, turn off the fan by pressing the switch (A).

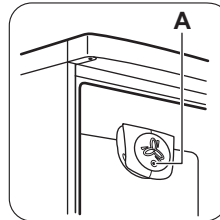

Switch on the fan when the ambient temperature exceeds 25°C.

Movable shelves

The walls of the refrigerator are equipped with a series of runners so that the shelves can be positioned as desired.

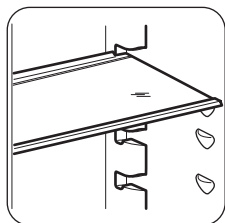

Positioning the door shelves

To permit storage of food packages of various sizes, the door shelves can be placed at different heights.

Gradually pull the shelf in the direction of the arrows until it comes free, then reposition as required.

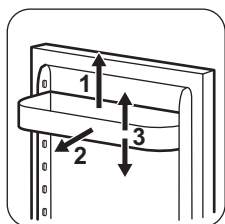

Bottle rack

Place bottles (with the opening facing front) in the pre-positioned shelf.

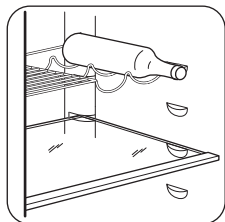

Hints and tips

Normal operating sounds

The following sounds are normal during operation:

- A faint gurgling and bubbling sound from coils sound when refrigerant is pumped.
- A whirring and pulsating sound from the compressor when refrigerant is pumped.
- A sudden cracking noise from inside appliance caused by thermic dilatation (a

Low temperature compartment

The low temperature compartment is suitable for storing fresh food like fish, meat, seafood, because the temperature inside is lower than the rest of the fridge.

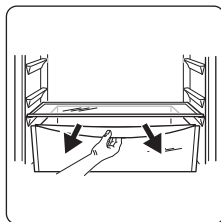

Removal of freezer baskets

The freezing baskets have a limit stop to prevent their accidental removal or falling out. At the time of its removal from the freezer, pull the basket towards yourself and, upon reaching the end point, remove the basket by tilting its front upwards.

At the time of putting it back, slightly lift the front of the basket to insert it into the freezer. Once you are over the end points, push the baskets back in their position.

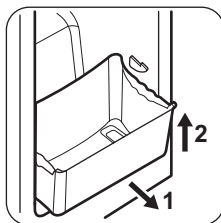

natural and not dangerous physical phenomenon).

- A faint click noise from the temperature regulator when the compressor switches on or off.

Hints for energy saving

- Do not open the door frequently or leave it open longer than absolutely necessary.

Hints for fresh food refrigeration

To obtain the best performance:

- do not store warm food or evaporating liquids in the refrigerator
- do cover or wrap the food, particularly if it has a strong flavour
- position food so that air can circulate freely around it

Hints for refrigeration

Useful hints:

- Meat (all types) : wrap in polythene bags and place on the glass shelf above the vegetable drawer.
- For safety, store in this way only one or two days at the most.
- Cooked foods, cold dishes, etc...: these should be covered and may be placed on any shelf.
- Fruit and vegetables: these should be thoroughly cleaned and placed in the special drawer(s) provided.
- Butter and cheese: these should be placed in special airtight containers or wrapped in aluminium foil or polythene bags to exclude as much air as possible.
- Bottles: these need a cap and should be stored on the door bottle shelf, or (if equipped) on the bottle rack.
- Bananas, potatoes, onions and garlic, if not packed, must not be kept in the refrigerator.

Hints for freezing

To help you make the most of the freezing process, here are some important hints:

- the maximum quantity of food which can be frozen in 24 hours is shown on the rating plate;

- the freezing process takes 24 hours no further food to be frozen should be added during this period;
- freeze only top quality, fresh and thoroughly cleaned, foodstuffs;
- prepare food in small portions to enable it to be rapidly and completely frozen and to make it possible subsequently to thaw only the quantity required;
- wrap up the food in aluminium foil or polythene and make sure that the packages are airtight;
- do not allow fresh, unfrozen food to touch food which is already frozen, thus avoiding a rise in temperature of the latter;
- lean foods store better and longer than fatty ones; salt reduces the storage life of food;
- water ices, if consumed immediately after removal from the freezer compartment, can possibly cause the skin to be freeze burnt;
- it is advisable to show the freezing in date on each individual pack to enable you to keep tab of the storage time.

Hints for storage of frozen food

To obtain the best performance from this appliance, you should:

- make sure that the commercially frozen foodstuffs were adequately stored by the retailer;
- be sure that frozen foodstuffs are transferred from the foodstore to the freezer in the shortest possible time;
- not open the door frequently or leave it open longer than absolutely necessary;
- once defrosted, food deteriorates rapidly and cannot be refrozen;
- do not exceed the storage period indicated by the food manufacturer.

Care and cleaning



WARNING!

Refer to Safety chapters.

Periodic cleaning

The equipment has to be cleaned regularly:

- clean the inside and accessories with lukewarm water and some neutral soap.
- regularly check the door seals and wipe clean to ensure they are clean and free from debris.

- rinse and dry thoroughly.



Do not pull, move or damage any pipes and/or cables inside the cabinet.

Never use detergents, abrasive powders, highly perfumed cleaning products or wax polishes to clean the interior as this will damage the surface and leave a strong odour.

The lowest shelf, dividing the cooler compartment from the 0°C compartment can be removed only for cleaning. To remove it pull out the shelf straight. The cover plates above the drawers in the compartment can be taken out for cleaning.

 To ensure the best performance of the 0°C compartment the lowest shelf and cover plates must be put back in their original position after cleaning.

Defrosting

Your appliance is frost free. This means that there is no build up of frost when it is in operation, neither on the internal walls nor on the foods.

The absence of frost is due to the continuous circulation of cold air inside the compartment, driven by an automatically controlled fan.

Periods of non-operation

When the appliance is not in use for long periods, take the following precautions:

1. Disconnect the appliance from electricity supply.
2. Remove all food.
3. Leave the door/doors open to prevent unpleasant smells.



WARNING!

If the cabinet will be kept on, ask somebody to check it once in a while to prevent the food inside from spoiling in case of a power failure.

Troubleshooting



WARNING!

Refer to Safety chapters.

What to do if...

Problem	Possible cause	Solution
The appliance does not operate.	The appliance is switched off.	Switch on the appliance.
	The mains plug is not connected to the mains socket correctly.	Connect the mains plug to the mains socket correctly.
	There is no voltage in the mains socket.	Connect a different electrical appliance to the mains socket. Contact a qualified electrician.
The appliance is noisy.	The appliance is not supported properly.	Check if the appliance stands stable.
The lamp does not work.	The lamp is in stand-by.	Close and open the door.
The lamp does not work.	The lamp is defective.	Contact the nearest Authorised Service Centre.
The compressor operates continually.	Temperature is set incorrectly.	Refer to "Operation" chapter.
	Many food products were put in at the same time.	Wait some hours and then check the temperature again.

Problem	Possible cause	Solution
	The room temperature is too high.	Refer to climate class chart on the rating plate.
	Food products placed in the appliance were too warm.	Allow food products to cool to room temperature before storing.
	The door is not closed correctly.	Refer to "Closing the door".
	The QuickFreeze function is switched on.	Refer to "QuickFreeze function".
The compressor does not start immediately after pressing the QuickFreeze, or after changing the temperature.	This is normal, no error has occurred.	The compressor starts after a period of time.
Water flows inside the refrigerator.	The water outlet is clogged.	Clean the water outlet.
	Food products prevent that water flows into the water collector.	Make sure that food products do not touch the rear plate.
Temperature cannot be set.	The QuickFreeze or QuickChill function is switched on.	Switch off QuickFreeze or QuickChill manually, or wait until the function resets automatically to set the temperature. Refer to "QuickFreeze or QuickChill function".
Door is misaligned or interferes with ventilation grill.	The appliance is not levelled.	Refer to "Levelling".
The temperature in the appliance is too low/too high.	The temperature regulator is not set correctly.	Set a higher/lower temperature.
	The door is not closed correctly.	Refer to "Closing the door".
	The food products' temperature is too high.	Let the food products temperature decrease to room temperature before storage.
	Many food products are stored at the same time.	Store less food products at the same time.
	The door has been opened often.	Open the door only if necessary.
	The QuickFreeze function is switched on.	Refer to "QuickFreeze function".
	There is no cold air circulation in the appliance.	Make sure that there is cold air circulation in the appliance.

i If the advice does not lead to the desired result, contact the nearest Authorised Service Centre.

Closing the door

1. Clean the door gaskets.
2. If necessary, adjust the door. Refer to "Installation".
3. If necessary, replace the defective door gaskets. Contact the Authorised Service Centre.

Installation

WARNING!
Refer to Safety chapters.

Positioning

This appliance can be installed in a dry, well ventilated indoor where the ambient temperature corresponds to the climate class indicated on the rating plate of the appliance:

Climate class	Ambient temperature
SN	+10°C to + 32°C
N	+16°C to + 32°C
ST	+16°C to + 38°C
T	+16°C to + 43°C

i Some functional problems might occur for some types of models when operating outside of that range. The correct operation can only be guaranteed within the specified temperature range. If you have any doubts regarding where to install the appliance, please turn to the vendor, to our customer service or to the nearest Authorised Service Centre.

Replacing the lamp

The appliance is equipped with a longlife LED interior light.

Only service is allowed to replace the lighting device. Contact your Authorised Service Centre.

Electrical Connection

CAUTION!
Any electrical work required to install this appliance should be carried out by a qualified electrician or competent person.

WARNING!
This appliance must be earthed. The manufacturer declines any liability should these safety measures not be observed.

The wires in the mains lead are coloured in accordance with the following code:

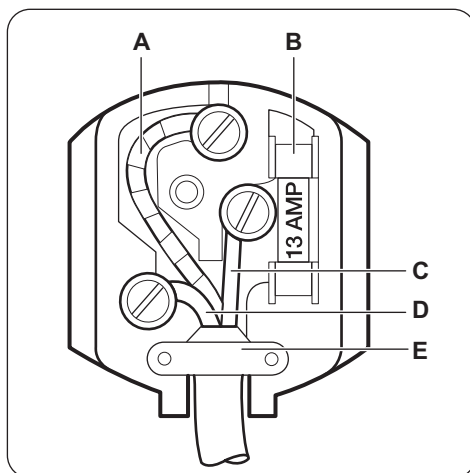

- **A** - green and yellow: Earth
- **C** - brown: Live
- **D** - blue: Neutral

As the colours of the wires in the mains lead of this appliance may not correspond with the coloured markings identifying the terminals in your plug, proceed as follows:

1. Connect the wire coloured green and yellow to the terminal marked either with the letter "E" or by the earth symbol  or coloured green and yellow.
2. Connect the wire coloured blue to the terminal either marked with the letter "N" or coloured black.
3. Connect the wire coloured brown to the terminal either marked with the "L" or coloured red.
4. Check that no cut, or stray strands of wire is present and the cord clamp **(E)** is secure over the outer sheath.
Make sure the electricity supply voltage is the same as that indicated on the appliance rating plate.

5. Switch on the appliance.

The appliance is supplied with a 13 amp fuse **(B)**. In the event of having to change the fuse in the plug supplied, a 13 amp ASTA approved (BS 1362) fuse must be used.



WARNING!

A cut off plug inserted into a 13 amp socket is a serious safety (shock) hazard. Ensure that it is disposed of safely.

Installation of the appliance and door reversal



Please refer to separate instructions on installation (ventilation requirements, levelling) and door reversal.

Technical information

Technical data

Height	mm	2005
Width	mm	595
Depth	mm	642
Rising time	Hours	18
Voltage	Volts	230 - 240
Frequency	Hz	50

The technical information are situated in the rating plate, on the external or internal side of the appliance and in the energy label.

ENVIRONMENT CONCERNS

Recycle the materials with the symbol . Put the packaging in applicable containers to recycle it. Help protect the environment and human health and to recycle waste of electrical and electronic appliances. Do not dispose

appliances marked with the symbol  with the household waste. Return the product to your local recycling facility or contact your municipal office.



www.zanussi.com/shop



280155046-A-072015

Free Manuals Download Website

<http://myh66.com>

<http://usermanuals.us>

<http://www.somanuals.com>

<http://www.4manuals.cc>

<http://www.manual-lib.com>

<http://www.404manual.com>

<http://www.luxmanual.com>

<http://aubethermostatmanual.com>

Golf course search by state

<http://golfingnear.com>

Email search by domain

<http://emailbydomain.com>

Auto manuals search

<http://auto.somanuals.com>

TV manuals search

<http://tv.somanuals.com>