

User Manual

# GETTING STARTED? EASY.



ZWF 71243W

EN User Manual  
Washing Machine

# ZANUSSI

## SAFETY INFORMATION

---

Before the installation and use of the appliance, carefully read the supplied instructions. The manufacturer is not responsible for any injuries or damage that are the result of incorrect installation or usage. Always keep the instructions in a safe and accessible location for future reference.

### **CHILDREN AND VULNERABLE PEOPLE SAFETY**

- This appliance can be used by children aged from 8 years and above and persons with reduced physical, sensory or mental capabilities or lack of experience and knowledge if they have been given supervision or instruction concerning the use of the appliance in a safe way and understand the hazards involved.
- Children between 3 and 8 years of age and persons with very extensive and complex disabilities shall be kept away from the appliance unless continuously supervised.
- Children of less than 3 years of age should be kept away from the appliance unless continuously supervised.
- Do not let children play with the appliance.
- Keep all packaging away from children and dispose of it appropriately.
- Keep detergents away from children.
- Keep children and pets away from the appliance when the door is open.
- If the appliance has a child safety device, it should be activated.
- Children shall not carry out cleaning and user maintenance of the appliance without supervision.

### **GENERAL SAFETY**

- Do not change the specification of this appliance.
- This appliance is intended to be used in household and similar applications such as:
  - staff kitchen areas in shops, offices and other working environments;
  - by clients in hotels, motels, bed & breakfast and other residential type environments;

- areas for communal use in blocks of flats or in launderettes.
- Do not exceed the maximum load of 7 kg (refer to the "Programme chart" chapter).
- The operating water pressure at the water entry point from the outlet connection must be between 0.5 bar (0.05 MPa) and 8 bar (0.8 MPa).
- The ventilation opening in the base must not be covered by a carpet, mat, or any floor covering.
- The appliance must be connected to the water mains using the new supplied hose sets, or other new hose sets supplied by the Authorised Service Centre.
- Old hose sets must not be reused.
- If the mains power supply cable is damaged, it must be replaced by the manufacturer, its Authorised Service Centre or similarly qualified persons to avoid an electrical hazard.
- Before any maintenance operation, deactivate the appliance and disconnect the mains plug from the socket.
- Do not use high pressure water sprays and/or steam to clean the appliance.
- Clean the appliance with a moist cloth. Use only neutral detergents. Do not use abrasive products, abrasive cleaning pads, solvents or metal objects.

## SAFETY INSTRUCTIONS

---

### INSTALLATION



The installation must comply with relevant national regulations.

- Remove all the packaging and the transit bolts including rubber bush with plastic spacer.
- Keep the transit bolts in a safe place. If the appliance is to be moved in the future they must be reattached to lock the drum to prevent an internal damage.
- Always take care when moving the appliance as it is heavy. Always use safety gloves and enclosed footwear.
- Follow the installation instructions supplied with the appliance.
- Do not install or use a damaged appliance.
- Do not install or use the appliance where the temperature can be less than 0°C or where it is exposed to the weather.
- The floor area on which the appliance is to be installed must be flat, stable, heat resistant and clean.
- Make sure that there is air circulation between the appliance and the floor.
- When the appliance is in its permanent position, check if it is levelled correctly with the aid of a spirit level. If it is not, adjust the feet accordingly.
- Do not install the appliance directly above a floor drain.
- Do not spray water on the appliance and do not expose it to excessive humidity.
- Do not install the appliance where the appliance door cannot be fully opened.
- Do not put a closed container to collect possible water leakage under the appliance. Contact the Authorised Service Centre to ensure which accessories can be used.

## ELECTRICAL CONNECTION



**WARNING!** Risk of fire and electric shock.

- The appliance must be earthed.
- Always use a correctly installed shockproof socket.
- Make sure that the parameters on the rating plate are compatible with the electrical ratings of the mains power supply.
- Do not use multi-plug adapters and extension cables.
- Make sure not to cause damage to the mains plug and to the mains cable. Should the mains cable need to be replaced, this must be carried out by our Authorised Service Centre.
- Connect the mains plug to the mains socket only at the end of the installation. Make sure that there is access to the mains plug after the installation.
- Do not touch the mains cable or the mains plug with wet hands.
- Do not pull the mains cable to disconnect the appliance. Always pull the mains plug.

## WATER CONNECTION

- Do not cause damage to the water hoses.
- Before connection to new pipes, pipes not used for a long time, where repair work has been carried out or new devices fitted (water meters, etc.), let the water flow until it is clean and clear.
- Ensure that there are no visible water leaks during and after the first use of the appliance.
- Do not use an extension hose if the inlet hose is too short. Contact the Authorised Service Centre for the replacement of the inlet hose.
- When unpacking the appliance, It is possible to see water flowing from the drain hose. This is due to the testing of the appliance with the use of water in the factory.
- You can extend the drain hose to maximum 400 cm. Contact the Authorised Service Centre for the other drain hose and the extension.

- Make sure that there is access to the tap after the installation.

## USE



**WARNING!** Risk of injury, electric shock, fire, burns or damage to the appliance.

- Follow the safety instructions on the detergent packaging.
- Do not put flammable products or items that are wet with flammable products in, near or on the appliance.
- Do not wash fabrics which are heavily soiled with oil, grease or other greasy substances. It can damage rubber parts of the washing machine. Prewash such fabrics by hand before loading them into the washing machine.
- Do not touch the glass door while a programme is in operation. The glass can get hot.
- Make sure that all metal objects are removed from the laundry.

## SERVICE

- To repair the appliance contact the Authorised Service Centre.
- Use original spare parts only.

## DISPOSAL



**WARNING!** Risk of injury or suffocation.

- Disconnect the appliance from the mains electrical and water supplies.
- Cut off the mains electrical cable close to the appliance and dispose of it.
- Remove the door catch to prevent children or pets from becoming trapped in the drum.
- Dispose of the appliance in accordance with local requirements for the disposal of Waste Electrical and Electronic Equipment (WEEE).

# PRODUCT DESCRIPTION

---

## APPLIANCE OVERVIEW

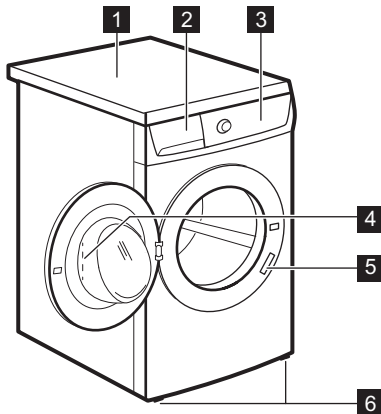

- 1 Worktop
- 2 Detergent dispenser
- 3 Control panel
- 4 Door handle
- 5 Rating plate
- 6 Feet for levelling the appliance

## CHILD SAFETY

This device prevents children or pets to be closed in the drum.

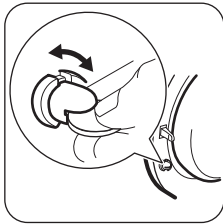

- Turn the device clockwise, until the groove is horizontal. You cannot close the door.
- To close the door, turn the device anti-clockwise until the groove is vertical.

## FIXING PLATE KIT (4055171146)

Available from your authorised dealer.

If you install the appliance on a plinth, secure the appliance in the fixing plates.

Read carefully the instructions supplied with the accessory.

# EASY START

## CONTROL PANEL DESCRIPTION

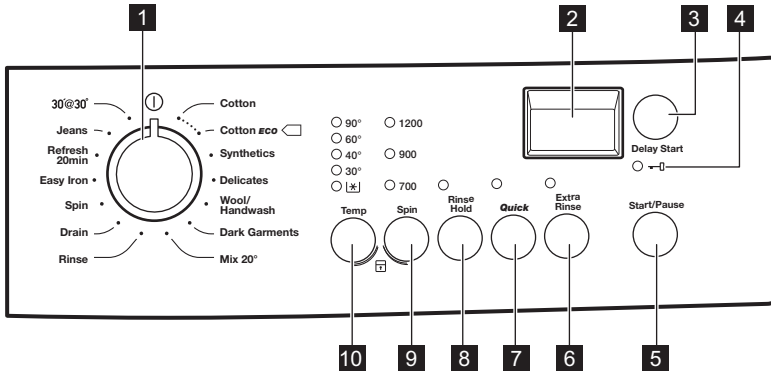

- 1** Programme knob
- 2** Display
- 3** Delay Start button (Delay Start)
- 4** Door locked indicator 
- 5** Start/Pause button (Start/Pause)
- 6** Extra Rinse button (Extra Rinse)

- 7** Super Quick button (Quick)
- 8** Rinse Hold button (Rinse Hold)
- 9** Spin reduction button (Spin)
- 10** Temperature button (Temp)

## DISPLAY

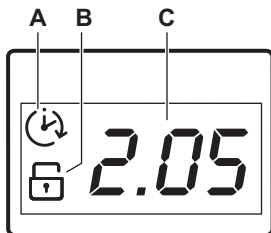

The display shows:

- A.** The delay start .  
When you press the delay start button, the display shows the delay start time.
- B.** The child lock indicator.  
The indicator comes on the display when the related option is set.
- C.** This area shows:
  - The programme time.
  - The alarm codes.  
If the appliance has a malfunction, the display shows the alarm codes. Refer to the chapter 'Troubleshooting' .
  - The display shows the message **E r r** for some seconds if:
    - You set a option that is not suitable for the programme.
    - You change the programme while it operates.

# PROGRAMME CHART

Programme Temperature range	Maximum load Maximum spin speed	Programme description (Type of load and soil level)
Cotton 90°C - Cold	7 kg 1200 rpm	<b>White cotton and coloured cotton.</b> Normal, heavy and light soil.
 Cotton ECO <sup>1)</sup> 60°C - 40°C	7 kg 1200 rpm	<b>White cotton and fast-coloured cotton.</b> Normal soil. The energy consumption decreases and the time of the washing programme is extended, ensuring good washing results.
Synthetics 60°C - Cold	3 kg 1200 rpm	<b>Synthetic items or mixed fabric items.</b> Normal soil.
Delicates 40°C - Cold	3 kg 700 rpm	<b>Delicate fabrics such as acrylics, viscose and mixed fabrics requiring gentler washing.</b> Normal soil.
Wool/Handwash 40°C - Cold	1,5 kg 1200 rpm	<b>Machine washable wool, hand washable wool and other fabrics</b> with «hand washing» care symbol <sup>2)</sup> .
Dark Garments 40°C	3 kg 1200 rpm	<b>Cotton items or mixed fabric items in dark colours.</b> Normal soil.
Mix 20° 20°C	2 kg 1200 rpm	Special programme for cotton, synthetic and mixed fabrics lightly soiled. Select this programme to reduce the energy consumption. Make sure that the detergent is suitable for low temperatures in order to have good washing results <sup>3)</sup> .
Rinse	7 kg 1200 rpm <sup>4)</sup>	To rinse and spin the laundry. <b>All fabrics</b> , except woollens and very delicate fabrics. Reduce the spin speed accordingly to the type of laundry.
Drain	7 kg	To drain the water in the drum. <b>All fabrics.</b>
Spin	7 kg 1200 rpm	<b>All fabrics, except woollens and delicate fabrics.</b> To spin the laundry and to drain the water in the drum.
Easy Iron 60°C - Cold	1 kg 900 rpm	<b>Synthetic items requiring a gentle wash.</b> Normal and light soil. <sup>5)</sup>
Refresh 20min 30°C	1 kg 900 rpm	<b>Synthetic and delicate items.</b> Light soil items or items to refresh.
Jeans 60°C - Cold	3 kg 1200 rpm	<b>Items in denim and jersey.</b> Normal soil.

Programme Temperature range	Maximum load Maximum spin speed	Programme description (Type of load and soil level)
30'@ 30° 30°C	3 kg 700 rpm	A short cycle for <b>synthetic and delicate items with light soil level</b> or for items to freshen up.

**1) Standard programmes for the Energy Label consumption values.** According to regulation 1061/2010, these programmes are respectively the «Standard 60°C cotton programme» and the «Standard 40°C cotton programme». They are the most efficient programmes in terms of combined energy and water consumption for washing normally soiled cotton laundry.



The water temperature of the washing phase may differ from the temperature declared for the selected programme.

- 2) During this cycle the drum rotates slowly to ensure a gentle wash. It can seem that the drum doesn't rotate or doesn't rotate properly, but this is normal for this programme.
- 3) The appliance performs the short heating phase if the water temperature is below 20°C. The appliance can show the temperature setting as "cold".
- 4) The default spin speed is 700 rpm.
- 5) To reduce creasing, this cycle regulates the water temperature and performs a soft wash and spin phase. The appliance adds some rinses.

### Programme options compatibility

Programme	Spin	Rinse Hold	Quick <sup>1)</sup>	Extra Rinse	Delay Start
Cotton	■	■	■	■	■
 Cotton ECO	■	■		■	■
Synthetics	■	■	■	■	■
Delicates		■	■	■	■
Wool/Handwash	■	■			■
Dark Garments	■	■		■	■
Mix 20°	■	■		■	■
Rinse	■	■		■	■
Drain					■
Spin	■				■
Easy Iron	■	■		■	■
Refresh 20min	■				■
Jeans	■	■			■
30'@ 30°					■

**1)** When you set the Quick option, we recommend that you decrease the quantity of the laundry. It is possible to keep the full load but the washing results can be unsatisfactory. Recommended load: cotton: 3,5 kg, synthetics and delicates: 1,5 kg.



# CONSUMPTION VALUES



Stated values are obtained in laboratory conditions with relevant standards. Different causes can change the data: the quantity and type of laundry and ambient temperature. Water pressure, the supply voltage and the temperature of inlet water may also affect the washing programme duration.



Technical specifications may be changed without prior notice to improve the quality of product.





At the start of the programme, the display shows the programme duration for the maximum load capacity.

During the washing phase the programme duration is automatically calculated and can be greatly reduced if the laundry load is lower than the maximum load capacity (e.g. Cotton 60°C, maximum load capacity 7 kg, the programme duration exceeds 2 hours; actual load 1 kg, the programme duration will be less than 1 hour).

When the appliance is calculating the real programme duration a dot flashes in the display.

Programmes	Load (kg)	Energy consumption (kWh)	Water consumption (litre)	Approximate programme duration (minutes)	Remaining moisture (%) <sup>1)</sup>
Cotton 60°C	7	1,34	68	157	53
Cotton 40°C	7	0,78	61	157	53
Synthetics 40°C	3	0,60	56	103	35
Delicates 40°C	3	0,55	59	81	35
Wool/Handwash 30°C <sup>2)</sup>	1,5	0,45	62	75	30

## Standard cotton programmes

Standard 60°C cotton 	7	0,92	44	250	53
Standard 60°C cotton 	3,5	0,68	35	204	53
Standard 40°C cotton 	3,5	0,59	36	189	53

1) At the end of spin phase.

2) Not available for some models.

Off Mode (W)	Left On Mode (W)
0.48	0.48

The information given in the chart above is compliant with the EU Commission regulation 1015/2010 implementing directive 2009/125/EC .

## OPTIONS

### TEMP

With this option you can change the default temperature.

Indicator  = cold water.

The indicator of the set temperature comes on.

### SPIN

With this option you can change the default spin speed.

The indicator of the set speed comes on.

### RINSE HOLD

Set this option to prevent the laundry creases.

The related indicator comes on.



There is water in a drum when the programme completes. To drain the water refer to 'At the end of the programme'.

### QUICK

Press this button to decrease the programme duration.

Set this option for items with light soil or items to refresh.

### EXTRA RINSE

With this option you can add some rinses to a washing programme.

Use this option for persons allergic to detergents and in areas where the water is soft.

The related indicator comes on.

### DELAY START

With this option you can delay the start of a programme from 30 minutes to 20 hours.

The display shows the related indicator.

### DOOR LOCKED INDICATOR

The indicator  shows when the door can be opened:

- The indicator is on: the door cannot be opened.
- The indicator flashes: the door is opening in some minutes.
- The indicator is off: the door can be opened.

## SETTINGS

### CHILD LOCK

With this option you can prevent that the children play with the control panel.

- To **activate/deactivate** this option, press Temp and Spin at the same time until the indicator  **comes on/goes off**.

You can activate this option:

- After you press Start/Pause: the options and the programme knob are locked.
- Before you press Start/Pause: the appliance cannot start.

### ACOUSTIC SIGNALS

The acoustic signals operate when:

- The programme is completed.
- The appliance has a malfunction.

To **deactivate/activate** the acoustic signals, press Rinse Hold and Quick at the same time for 6 seconds.



If you deactivate the acoustic signals, they continue to operate when the appliance has a malfunction.

### EXTRA RINSE

With this option you can permanently have an extra rinse when you set a new programme.

- To **activate/deactivate** this option touch the buttons **Rinse Hold** and **Extra Rinse** at the

same time until the indicator of **Extra Rinse** button **comes on/goes off**.

## BEFORE FIRST USE



During installation or before first use you may observe some water in the appliance. This is residual water left in the appliance after a full functional test in the factory to ensure the appliance is delivered to customers in perfect working order and is no cause for concern.

1. Connect the mains plug to the mains socket.
2. Open the water tap.
3. Put a small quantity of detergent in the compartment for washing phase.
4. Set and start a programme for cotton at the highest temperature without laundry.

This removes all possible dirt from the drum and the tub.

## DAILY USE



**WARNING!** Refer to Safety chapters.

### LOADING THE LAUNDRY

Open the water tap. Connect the mains plug to the mains socket.

1. Pull the door handle to open the appliance door.
2. Put the laundry in the drum, one item at a time.
3. Shake the items before you put them in the appliance.

Make sure not to put too much laundry in the drum. Refer to max. loads indicated in "Programme chart".

4. Close the door.

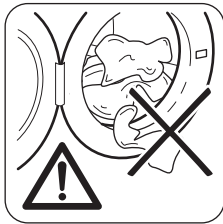

**CAUTION!** Make sure that no laundry stays between the seal and the door. There is a risk of water leakage or damage to the laundry.



Washing heavily oiled, greasy stains could cause damage rubber parts of the washing machine.

### USING DETERGENT AND ADDITIVES

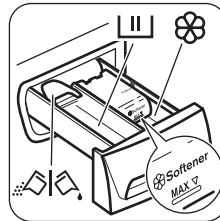

1. Measure out the detergent and the fabric conditioner.
2. Put the detergent and the fabric conditioner into the compartments.
3. Carefully close the detergent drawer.

### DETERGENT COMPARTMENTS



Detergent compartment for washing phase.

If you use liquid detergent, put it immediately before you start the programme.



Compartment for liquid additives (fabric conditioner, starch).



**CAUTION!** Do not exceed the **MAX** level.



Flap for powder or liquid detergent.

## LIQUID OR POWDER DETERGENT

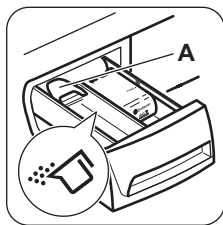

The default position of the flap is **A** (powder detergent).

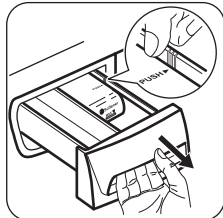

To use liquid detergent:  
1. Remove the drawer. Push the drawer edge in the place with the arrow (PUSH) to remove the drawer easily.

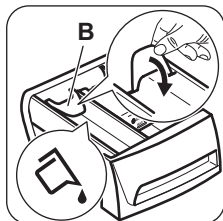

2. Adjust the flap in position **B**.  
3. Put back the drawer in the recess.



- When you use the liquid detergent:
- Do not use gelatinous or thick liquid detergents.
  - Do not put more liquid than 120 ml.
  - Do not set the delay start.

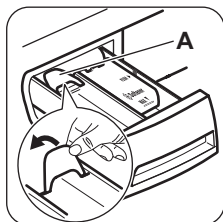

When the flap is in position **B** and you want to use powder detergent:  
1. Remove the drawer.  
2. Adjust the flap in position **A**.  
3. Put back the drawer in the recess.

## SETTING A PROGRAMME

1. Turn the programme knob to switch the appliance on and set the programme:
  - The indicator of the button **Start/Pause** flashes.
  - The display shows the programme duration.
2. If necessary, change the temperature and the spin speed or add available options. When you

activate an option, the indicator of the set option comes on.



If you set something incorrect, the display shows the message **E r r**.

## STARTING A PROGRAMME WITHOUT THE DELAY START

Press the button Start/Pause.

- The indicator of the button Start/Pause stops to flash and stays on.
- The programme starts, the door locks, the indicator  is on.
- The programme time decreases with steps of one minute.



The drain pump can operate for a short time at the beginning of the washing cycle.

## STARTING A PROGRAMME WITH THE DELAY START OPTION

1. Press the button Delay Start again and again until the display shows the delay you want to set. The delay start indicator comes on.
2. Press the button Start/Pause:
  - The door is locked and the indicator  is on.
  - The appliance starts the countdown.
  - When the countdown is completed, the programme starts automatically.



You can cancel or change the set of the Delay Start option before you press the button Start/Pause. After pressing the button Start/Pause you can only cancel the Delay Start option.

To cancel the Delay Start option:

- a. Press the button Start/Pause to set the appliance to pause. The indicator of button Start/Pause flashes.
- b. Press the button Delay Start until the display shows . Press the button Start/Pause again to start the programme immediately.

## INTERRUPTING A PROGRAMME AND CHANGING THE OPTIONS

You can change only some options before they operate.

1. Press the button Start/Pause. The indicator flashes.
2. Change the options.

3. Press the button Start/Pause again.

The programme continues.

## CANCELLING A RUNNING PROGRAMME

1. Turn the programme knob to position ① to cancel the programme and to deactivate the appliance.
2. Turn the programme knob again to activate the appliance. Now, you can set a new washing programme.



Before starting the new programme the appliance could drain the water. In this case, make sure that the detergent is still in the detergent compartment, if not fill the detergent again.

## OPENING THE DOOR

While a programme or the Delay Start operates, the appliance door is locked. The indicator  is on.



**CAUTION!** If the temperature and level of the water in the drum are too high and the drum still rotates, you cannot open the door.

To open the door during the first minutes of the cycle or when the Delay Start operates:

1. Press the button Start/Pause to pause the appliance.
2. Wait until the indicator  goes off.
3. You can open the door.
4. Close the door and touch the button Start/Pause again. The programme (or the Delay Start) continues.

## AT THE END OF THE PROGRAMME

- The appliance stops automatically.
- The acoustic signal operates (if it is activated).
- In the display  comes on.
- The indicator of the button Start/Pause goes off.

## HINTS AND TIPS

### THE LAUNDRY LOAD

- Divide the laundry in: white, coloured, synthetics, delicates and wool.
- Obey the washing instructions that are on the laundry care labels.
- Do not wash white and coloured items together.
- Some coloured items can discolour with the first wash. We recommend that you wash them separately for the first times.
- Turn multilayered fabrics, wool and items with painted illustrations inside out.
- Remove hard stains with a special detergent.
- Wash and pre-treat heavy soil stains before putting items in drum
- Be careful with the curtains. Remove the hooks and put the curtains in a washing bag or pillowcase.
- Do not wash laundry without hems or with cuts. Use a washing bag to wash small and/or

- The door lock indicator  goes off.  
Turn the programme knob to position ① to deactivate the appliance.
- You can open the door.
- Remove the laundry from the appliance. Make sure that the drum is empty.
- Close the water tap.
- Keep the door and the detergent drawer ajar, to prevent the mildew and odours.

### The washing programme is completed, but there is water in the drum:

- The drum turns regularly to prevent the creases in the laundry.
- The indicator Rinse Hold stays on to remind you to drain the water.
- The door lock indicator  is on. The indicator of button Start/Pause is off. The door stays locked.
- You must drain the water to open the door.

### Draining the water:

1. To drain the water.
  - Set a Drain or a Spin programme.
  - Press the button Start/Pause. The appliance drains the water and spins.
2. When the programme is completed and the door lock indicator  goes off, you can open the door.
3. Turn the programme knob to the position ① to deactivate the appliance.

### STAND BY

Some minutes after the end of the washing programme, if you do not deactivate the appliance, the energy saving status activates. The energy saving status decreases the energy consumption when the appliance is on the standby:

- All indicators and the display go off.
  - The indicator of button Start flashes slowly.
- Press one of the buttons to deactivate the energy saving status.

delicate items (e.g. underwired bras, belts, tights, shoelaces, ribbons, etc. ).

- A very small load can cause balance problems with the spin phase. If this occurs, adjust manually the items in the tub and start the spin phase again.
- Avoid washing garments full of long animal hair or poor quality garments releasing lots of fluff that could block the drain circuit and therefore requiring the Service assistance.
- Button up pillowcases, close zippers, hooks and poppers. Tie up belts, cords, shoelaces, ribbons and any other loose elements.
- Empty the pockets and unfold the items.

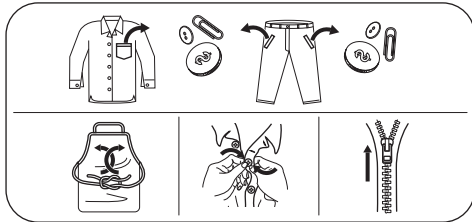

## STUBBORN STAINS

For some stains, water and detergent is not sufficient.

We recommend that you pre-treat these stains before you put the items in the appliance.

Special stain removers are available. Use the special stain remover that is applicable to the type of stain and fabric.

## DETERGENTS AND ADDITIVES

- Only use detergents and additives specially made for washing machines:
  - powder detergents for all types of fabric,
  - powder detergents for delicate fabrics (40 °C max) and woollens,

- liquid detergents, preferably for low temperature wash programmes (60 °C max) for all types of fabric, or special for woollens only.
- Do not mix different types of detergents.
- To help the environment, do not use more than the correct quantity of detergent.
- Obey the instructions that you find on the on packaging of these products.
- Use the correct products for the type and colour of the fabric, the programme temperature and the level of soil.
- If your appliance does not have the detergent dispenser with the flap device, add the liquid detergents with a dosing ball (supplied by the detergent's manufacturer).

## ECOLOGICAL HINTS

- Set a programme without the prewash phase to wash laundry with normal soil.
- Always start a washing programme with the maximum load of laundry allowed.
- If necessary, use a stain remover when you set a programme with a low temperature.
- To use the correct quantity of detergent, check the water hardness of your domestic system. Refer to "Water hardness".

## WATER HARDNESS

If the water hardness in your area is high or moderate, we recommend that you use a water softener for washing machines. In areas where the water hardness is soft it is not necessary to use a water softener.

To know the water hardness in your area, contact your local water authority.

Use the correct quantity of the water softener. Obey the instructions that you find on the packaging of the product.

## CARE AND CLEANING



**WARNING!** Refer to Safety chapters.

### EXTERNAL CLEANING

Clean the appliance with soap and warm water only. Fully dry all the surfaces.



**CAUTION!** Do not use alcohol, solvents or chemical products.

### DESCALING

If the water hardness in your area is high or moderate, we recommend that you use a water descaling product for washing machines.

Regularly examine the drum to prevent limescale and rust particles.

To remove rust particles use only special products for washing machines. Do this separately from the laundry wash.



Always obey the instructions that you find on the packaging of the product.

## MAINTENANCE WASH

With the low temperature programmes it is possible that some detergent stays in the drum. Perform a maintenance wash regularly. To do this:

- Remove all laundry from the drum.

## DOOR SEAL

This appliance is designed with a **self cleaning draining system**, allowing light fluff fibers that fall off the clothes to be drained out with the water, in such a way that there is no need to access this area for regular maintenance and cleaning.

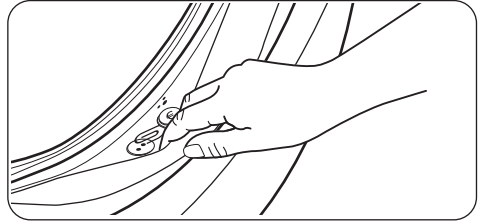

Regularly examine the seal and remove all objects from the inner part. Coins, buttons, other small items forgotten in the pockets of your clothes are deposited during the washing cycle in the special double lip trap in the porthole seal, where they can be conveniently recovered at the end of the cycle.

## CLEANING THE DETERGENT DISPENSER

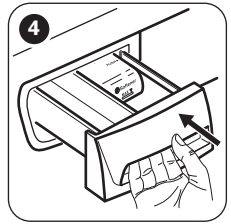
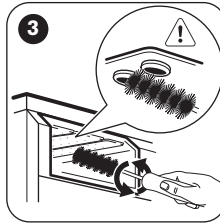
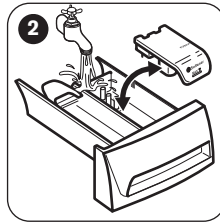
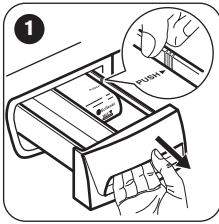

## CLEANING THE INLET HOSE AND THE VALVE FILTER

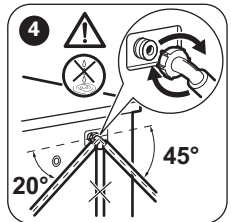
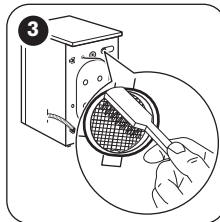
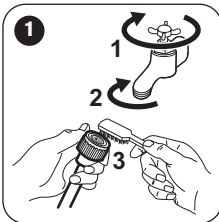

## FROST PRECAUTIONS

If the appliance is installed in an area where the temperature can be less than 0 °C, remove the remaining water from the inlet hose and the drain pump.

**i** Do this procedure also when you want to do the emergency drain.

1. Disconnect the mains plug from the mains socket.
2. Remove the water inlet hose.
3. Remove the drain hose from the rear support and unhook it from sink or spigot.
4. Put the ends of the drain and inlet hose in a container. Let the water flow out of the hoses.

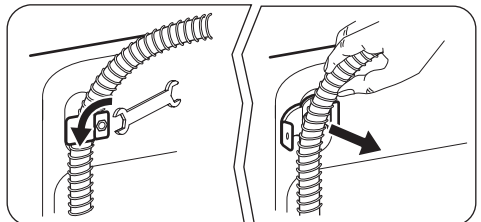

5. When no more water flows, install the inlet hose and the drain hose again.



**WARNING!** Make sure that the temperature is more than 0 °C before you use the appliance again. The manufacturer is not responsible for damages caused by low temperatures.

## TROUBLESHOOTING



**WARNING!** Refer to Safety chapters.

### INTRODUCTION

The appliance does not start or it stops during operation.

First try to find a solution to the problem (refer to the table). If the problem persists, contact the Authorised Service Centre.

**With some problems, the acoustic signals operate and the display shows an alarm code:**

- **E10** - The appliance does not fill with water properly. Start the appliance again by pressing Start/Pause button. After 10 seconds the door will be unlocked.
- **E20** - The appliance does not drain the water.
- **E40** - The appliance door is open or not closed correctly. Please check the door!
- **E90** - The mains supply is unstable. Wait until the mains supply is stable.



**WARNING!** Deactivate the appliance before you do the checks.

### POSSIBLE FAILURES

Problem	Possible solution
The programme does not start.	<ul style="list-style-type: none"> <li>▪ Make sure that the mains plug is connected to the mains socket.</li> <li>▪ Make sure that the appliance door is closed.</li> <li>▪ Make sure that there is not a damaged fuse in the fuse box.</li> <li>▪ Make sure that the Start/Pause has been pressed.</li> <li>▪ If the delay start is set, cancel the setting or wait for the end of countdown.</li> <li>▪ Deactivate the Child Lock function if it is on (if available).</li> </ul>
The appliance does not fill with water properly.	<ul style="list-style-type: none"> <li>▪ Make sure that the water tap is open.</li> <li>▪ Make sure that the pressure of the water supply is not too low. For this information, contact your local water authority.</li> <li>▪ Make sure that the water tap is not clogged.</li> <li>▪ Make sure that the filter of the inlet hose and the filter of the valve are not clogged. Refer to "Care and cleaning".</li> <li>▪ Make sure that the inlet hose has no kinks or bends.</li> <li>▪ Make sure that the connection of the water inlet hose is correct.</li> <li>▪ Make sure that the drain hose is in the correct position. The hose may be too low.</li> </ul>



Problem	Possible solution
The appliance does not drain the water.	<ul style="list-style-type: none"> <li>▪ Make sure that the sink spigot is not clogged.</li> <li>▪ Make sure that the drain hose has no kinks or bends.</li> <li>▪ Make sure that the connection of the drain hose is correct.</li> <li>▪ Set the drain programme if you set a programme without drain phase.</li> <li>▪ Set the drain programme if you set an option which ends with water in the drum.</li> <li>▪ If above mentioned solutions do not help, contact the Authorised Service Centre (as the filter of the drain pump may be clogged).</li> </ul>
The spin phase does not operate or the washing cycle lasts longer than usually.	<ul style="list-style-type: none"> <li>▪ Set the spin programme.</li> <li>▪ Adjust manually the items in the tub and start the spin phase again. This problem may be caused by balance problems.</li> <li>▪ If above mentioned solutions do not help, contact the Authorised Service Centre (as the filter of the drain pump may be clogged).</li> </ul>
There is water on the floor.	<ul style="list-style-type: none"> <li>▪ Make sure that the couplings of the water hoses are tight and there is not water leakages.</li> <li>▪ Make sure that the inlet hose and/or the drain hose have no damages.</li> <li>▪ Make sure you use the correct detergent and the correct quantity of it.</li> </ul>
You cannot open the appliance door.	<ul style="list-style-type: none"> <li>▪ Make sure that the washing programme is finished.</li> <li>▪ Set the drain or the spin programme if there is water in the drum.</li> </ul>
The appliance makes an unusual noise.	<ul style="list-style-type: none"> <li>▪ Make sure the levelling of the appliance is correct. Refer to 'Installation Instruction'.</li> <li>▪ Make sure that the packaging and/or the transit bolts are removed. Refer to 'Installation Instruction'.</li> <li>▪ Add more laundry in the drum. The load may be too small.</li> </ul>
The cycle is shorter than the time displayed.	The appliance calculates a new time according to the laundry load. See the 'Consumption Values' chapter.
The cycle is longer than the time displayed.	An unbalanced laundry load increases the duration time. This is a normal behaviour of the appliance.
The washing results are not satisfactory.	<ul style="list-style-type: none"> <li>▪ Increase the detergent quantity or use a different detergent.</li> <li>▪ Use special products to remove the stubborn stains before you wash the laundry.</li> <li>▪ Make sure that you set the correct temperature.</li> <li>▪ Decrease the laundry load.</li> </ul>
You cannot set an option.	<ul style="list-style-type: none"> <li>▪ Make sure that you press only the wanted button(s).</li> </ul>

After the check, activate the appliance. The programme continues from the point of interruption. If the problem occurs again, contact the Authorised Service Centre.  
If the display shows other alarm codes. Deactivate and activate the appliance. If the problem continues, contact the Service.

## SERVICE

We recommend the use of original spare parts. When contacting the Authorised Service Centre, make sure that these data are available. You can find the information on the rating plate: model, PNC and Serial Number. (Mod., Prod. No., Ser. No.)

## TECHNICAL DATA

Dimension	Width/ Height/ Depth/ Total depth	600 mm/ 850 mm/ 559 mm/ 578 mm
Electrical connection	Voltage Overall power Fuse Frequency	220-230 V 2200 W 13 A 50 Hz
Level of protection against ingress of solid particles and moisture ensured by the protective cover, except where the low voltage equipment has no protection against moisture		IPX4
Water supply pressure	Minimum Maximum	0.5 bar (0.05 MPa) 8 bar (0.8 MPa)
Water supply <sup>1)</sup>		Cold water
Maximum Load	Cotton	7 kg
Energy Efficiency Class		A+++
Spin Speed	Maximum	1200 rpm

**1)** Connect the water inlet hose to a water tap with a 3/4" thread.

## ENVIRONMENTAL CONCERNS

Recycle materials with the symbol . Put the packaging in relevant containers to recycle it. Help protect the environment and human health by recycling waste of electrical and electronic appliances. Do not dispose of appliances marked

with the symbol  with the household waste. Return the product to your local recycling facility or contact your municipal office.



[WWW.ZANUSSI.COM/SHOP](http://WWW.ZANUSSI.COM/SHOP)



CE

192968641-A-312019

## Free Manuals Download Website

<http://myh66.com>

<http://usermanuals.us>

<http://www.somanuals.com>

<http://www.4manuals.cc>

<http://www.manual-lib.com>

<http://www.404manual.com>

<http://www.luxmanual.com>

<http://aubethermostatmanual.com>

Golf course search by state

<http://golfingnear.com>

Email search by domain

<http://emailbydomain.com>

Auto manuals search

<http://auto.somanuals.com>

TV manuals search

<http://tv.somanuals.com>