

EN

User Manual

USER MANUAL

Washing Machine

ZWF 71263W
ZWF 71463W

ZANUSSI

Contents

Safety information.....	2	Settings.....	9
Safety instructions.....	3	Before first use.....	10
Product description.....	4	Daily use.....	10
Control panel.....	5	Hints and tips.....	13
Programme Chart.....	6	Care and cleaning.....	14
Consumption values.....	7	Troubleshooting.....	15
Options.....	8	Technical Data.....	17

Subject to change without notice.

Safety information

Before the installation and use of the appliance, carefully read the supplied instructions. The manufacturer is not responsible if an incorrect installation and use causes injuries and damages. Always keep the instructions with the appliance for future reference.

Children and vulnerable people safety

- This appliance can be used by children aged from 8 years and above and persons with reduced physical, sensory or mental capabilities or lack of experience and knowledge if they have been given supervision or instruction concerning use of the appliance in a safe way and understand the hazards involved.
- Do not let children play with the appliance.
- Keep all packaging away from children.
- Keep all detergents away from children.
- Keep children and pets away from the appliance door when it is open.
- Cleaning and user maintenance shall not be made by children without supervision.

General Safety

- Do not change the specification of this appliance.
- Obey the maximum load volume of 7 kg (refer to the “Programme chart” chapter).
- The operating water pressure (minimum and maximum) must be between 0,5 bar (0,05 MPa) and 8 bar (0,8 MPa).

- The ventilation openings in the base (if applicable) must not be obstructed by a carpet.
- The appliance is to be connected to the water mains using the new supplied hose-sets. Old hose sets must not be reused.
- If the supply cord is damaged, it must be replaced by the manufacturer, its Authorised Service Centre or similarly qualified persons in order to avoid a hazard.
- Before maintenance, deactivate the appliance and disconnect the mains plug from the mains socket.
- Do not use water spray and steam to clean the appliance.
- Clean the appliance with a moist soft cloth. Only use neutral detergents. Do not use abrasive products, abrasive cleaning pads, solvents or metal objects.

Safety instructions

Installation

- Remove all the packaging and the transit bolts.
- Keep the transit bolts. When you move the appliance again you must block the drum.
- Always be careful when you move the appliance because it is heavy. Always wear safety gloves.
- Do not install or use a damaged appliance.
- Obey the installation instruction supplied with the appliance.
- Do not install or use the appliance where the temperature is less than 0 °C or where it is exposed to the weather.
- Make sure that the floor where you install the appliance is flat, stable, heat resistant and clean.
- Do not install the appliance where the appliance door can not be fully opened.
- Make sure that there is air circulation between the appliance and the floor.
- Adjust the feet to have the necessary space between the appliance and the carpet.

Electrical Connection

- The appliance must be earthed.
- Always use a correctly installed shockproof socket.
- Make sure that the electrical information on the rating plate agrees with the power supply. If not contact an electrician.

- Do not use multi-plug adapters and extension cables.
- Make sure not to cause damage to the mains plug and to the mains cable. Should the mains cable need to be replaced, this must be carried out by our Authorised Service Centre.
- Connect the mains plug to the mains socket only at the end of the installation. Make sure that there is access to the mains plug after the installation.
- Do not touch the mains cable or the mains plug with wet hands.
- Do not pull the mains cable to disconnect the appliance. Always pull the mains plug.
- Only for UK and Ireland: The appliance has a 13 amp mains plug. If it is necessary to change the fuse in the mains plug, use a 13 amp ASTA (BS 1362) fuse.
- This appliance complies with the E.E.C. Directives.

Water connection

- Make sure not to cause damage to the water hoses.
- Before you connect the appliance to new pipes or pipes not used for a long time, let the water flow until it is clean.
- The first time you use the appliance, make sure that there is no leakage.

Use



WARNING!

Risk of injury, electrical shock, fire, burns or damage to the appliance.

- Use this appliance in a household only.
- Obey the safety instructions on the detergent packaging.
- Do not put flammable products or items that are wet with flammable products in, near or on the appliance.
- Make sure that you remove all metal objects from the laundry.
- Do not put a container to collect possible water leakage under the appliance. Contact

the Authorised Service Centre to ensure which accessories can be used.

- Do not touch the glass of the door while a programme operates. The glass can be hot.

Disposal



WARNING!

Risk of injury or suffocation.

- Disconnect the appliance from the mains supply.
- Cut off the mains cable and discard it.
- Remove the door catch to prevent children and pets to get closed in the appliance.

Product description

Appliance overview

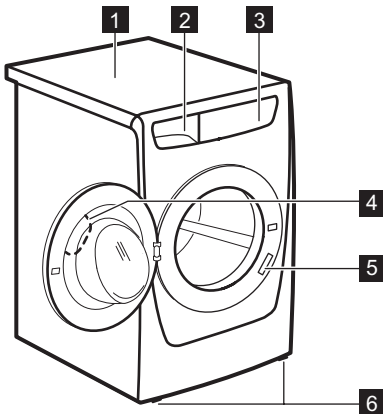

- 1 Worktop
- 2 Detergent dispenser
- 3 Control panel
- 4 Door handle
- 5 Rating plate
- 6 Feet for the appliance level

Installation on suspended flooring

Suspended wooden floors are particularly susceptible to vibration.

To help prevent vibration we recommend you place a waterproof wood panel, at least 15 mm thick under the appliance, secured to at least 2

floor beams with screws, the wood panel must extend beyond the front feet.

If possible install the appliance in one of the corners of the room, where the floor is more stable.

Control panel

Control panel description

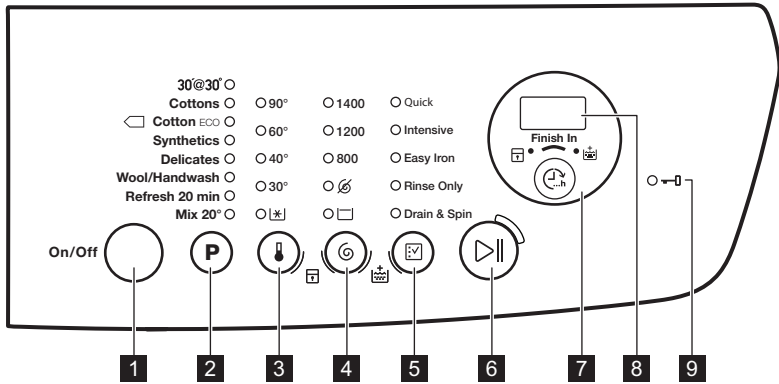

1 On / Off button (On/Off)

2 Programme selection touchpad P

3 Temperature touchpad

4 Spin selection touchpad

5 Options selection touchpad

6 Start/Pause touchpad

7 Finish in touchpad (Finish In)

8 Display

9 Door locked indicator

Display

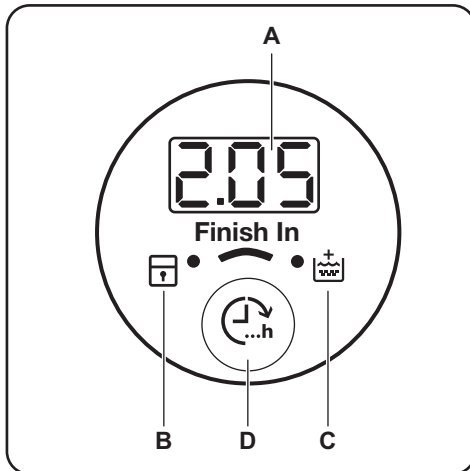

A) The time area:

- 1:25: the programme duration
- 3h: the "finish in" time
- E20: the alarm codes
- Err: the message of error
- 0: the programme is completed.

B) The child lock indicator:

- The indicator comes on when you activate this device.

C) The extra rinse indicator:

- The indicator comes on when you activate this option.

D) The Finish In button.

Programme Chart

Programme Temperature range	Maximum load Maximum spin speed Programme description (Type of load and soil level)
30' @ 30° 30 °C	A short cycle for synthetics and delicate items with light soil level or for items to freshen up. 3 kg 800 rpm for model ZWF 71263W; 800 rpm for model ZWF 71463W
Cottons 90 °C - Cold	White cotton and coloured cotton. Normal soil and light soil. 7 kg 1200 rpm for model ZWF 71263W; 1400 for model ZWF 71463W
 Cotton Eco ¹⁾ 60 °C - 40 °C	White cotton and colour-fast cotton. Normal soil. The energy consumption decreases and the time of the washing programme is extended. 7 kg 1200 rpm for model ZWF 71263W; 1400 for model ZWF 71463W
Synthetics 60 °C - Cold	Synthetic items or mixed fabric items. Normal soil. 3 kg 1200 rpm for model ZWF 71263W; 1200 rpm for model ZWF 71463W
Delicates 40 °C - Cold	Delicate fabrics as acrylics, viscose, polyester items. Normal soil. 3 kg 1200 rpm for model ZWF 71263W; 1200 rpm for model ZWF 71463W
Wool/Handwash 40 °C - Cold	Machine washable wool, hand washable wool and delicate fabrics with «hand washing» care symbol. ²⁾ 2 kg 1200 rpm for model ZWF 71263W; 1200 rpm for model ZWF 71463W
Refresh 20 min 40 °C - 30 °C	A very short cycle for cottons and synthetics items with light soil level or worn only once. 1 kg 1200 rpm for model ZWF 71263W; 1200 rpm for model ZWF 71463W
Mix 20° 20 °C	Special programme for cotton, synthetic and mixed fabrics with light soil. Set this programme to decrease the energy consumption. Make sure that the detergent is for low temperature in order to have good washing results ³⁾ . 2 kg 1200 rpm for model ZWF 71263W; 1200 for model ZWF 71463W

1) Standard programmes for the Energy Label consumption values. According to regulation 1061/2010, these programmes are re-spectively the «Standard 60°C cotton programme» and the «Standard 40°C cotton programme». They are the most efficient programmes in terms of combined energy and water consumption for washing normally soiled cotton laundry.







The water temperature of the washing phase may differ from the temperature declared for the selected programme.

2) During this cycle the drum rotates slowly to ensure a gentle washing. It can seem that the drum doesn't rotate or doesn't rotate properly. Consider this as a normal functioning of the appliance.

3) No temperature indicator is on .

Programme options compatibility

Pro-gramme				Quick ¹⁾	In-ten-sive	Easy Iron	Rinse Only	Drain & Spin		
30' @ 30°		■					■	■	■	
Cottons	■	■	■	■	■	■	■	■	■	■
Cotton Eco	■	■	■	■			■	■	■	■
Synthetics	■	■	■	■	■	■	■	■	■	■
Delicates	■	■	■	■	■		■	■	■	■
Wool/Hand-wash	■	■	■				■	■	■	
Refresh 20 min	■	■	■				■	■	■	
Mix 20°	■	■	■		■		■	■	■	

1) When you set this option, we recommend that you decrease the quantity of the laundry. It is possible to keep the full load but the washing results can be unsatisfactory. Recommended load: cotton: 3,5 kg, synthetics and delicates: 1,5 kg.

Consumption values



The data of this table are approximate. Different causes can change the data: the quantity and type of laundry, the water and ambient temperature.



At programme start the display shows the duration programme for the maximum load capacity. During the washing phase the programme duration is automatically calculated and can be greatly reduced if the laundry load is lower than the maximum load capacity (e.g. Cotton 60°C, maximum load capacity 7 kg, the programme duration exceeds 2 hours; real load 1 kg, the programme duration don't reach 1 hour). When the appliance is calculating the real programme duration a dot blinks in the display.

Pro-grammes	Load (kg)	Energy consumption (kWh)	Water consumption (litre)	Approximate programme duration (minutes)	Remaining moisture (%) ¹⁾
Cottons 60 °C	7	1,34	68	157	53 ²⁾ / 52 ³⁾
Cottons 40 °C	7	0,78	61	157	53 ²⁾ / 52 ³⁾
Synthetics 40 °C	3	0,60	56	103	35 ²⁾ / 35 ³⁾
Delicates 30 °C	3	0,55	59	81	35 ²⁾ / 35 ³⁾

Pro-grammes	Load (kg)	Energy con- sumption (kWh)	Water con- sumption (litre)	Approxi- mate pro- gramme du- ration (mi- nutes)	Remaining moisture (%) ¹⁾
Wool/Hand- wash 30 °C	2	0,30	53	57	30 ²⁾ / 30 ³⁾
Standard cotton programmes					
Standard 60 °C cotton	7	0,92	44	250	53 ²⁾ / 52 ³⁾
Standard 60 °C cotton	3,5	0,68	35	204	53 ²⁾ / 52 ³⁾
Standard 40 °C cotton	3,5	0,53	36	189	53 ²⁾ / 52 ³⁾

1) At the end of spin phase.

2) For model ZWF 71263W.

3) For model ZWF 71463W.

Off Mode (W)	Left On Mode (W)
0,48	0,48
The information given in the chart above are in compliance with the EU Commission regulation 1015/2010 implementing directive 2009/125/EC.	

Options

Temperature

With this option you can change the default temperature.

Indicator  = cold water.

The indicator of the set temperature comes on.

Spin

With this option you can change the default spin speed.

The indicator of the set speed comes on.

Additional spin options:

No Spin

- Set this option to deactivate all spin phases. Only the drain phase is available.
- The related indicator comes on.
- Set this option for very delicate fabrics.

- The rinses phase uses more water for some washing programmes.

Rinse Hold

- Set this option to prevent the laundry creases.
- The related indicator comes on.
- There is a water in the drum when the programme is completed.
- The drum turns regularly to prevent the laundry creases.
- The door stays locked. You must drain the water to unlock the door.

 To drain the water refer to 'At the end of the programme'.

Quick

With this option you can decrease the programme duration.

Use this option for items with light soil or items to refresh.

The related indicator comes on.

Intensive

With this option you can wash very soiled laundry.

The washing cycle lasts longer with this option.

The related indicator comes on.

Easy Iron

The appliance carefully washes and spins the laundry to prevent the creases.

The appliance decreases the spin speed, uses more water and adapts the programme duration to the type of laundry.

The related indicator comes on.

Rinse Only

With this option you can perform only a last rinse of a selected washing programme.

If you set also the Extra Rinse function (👉) the appliance adds two or more rinses.

The related indicator comes on.

Drain & Spin

With this option you can the spin and drain cycle.

Settings

Extra Rinse (👉)

With this option you can permanently have an extra rinse when you set a new programme.

- To **activate/deactivate** this option touch the buttons 🔄 and 📺 at the same time until the indicator 👉 **comes on/goes off**.

Child Lock (🔒)

With this option you can prevent that the children play with the control panel.

- To **activate/deactivate** this option, touch the buttons 🔒 and 🔄 at the same time until the indicator 🔒 **comes on/goes off**.

The spin phase is suitable to the washing programme you set.

 If you set also the No Spin (🚫) option, the appliance only drains.

Finish In (🕒)

With this option you can set the number of hours in which you would like your washing programme to be completed.

You can set from minimum 3 hours to maximum 20 hours.

The display shows the number of hours and the indicator above the button 🕒 is on.

Extra Rinse (👉)

With this option you can add some rinses to a washing programme.

Use this option for persons allergic to detergents and in areas where the water is soft.

The related indicator comes on.¹

Activate this option after you touch the button ▶||: the buttons are locked (except for the button 🕒).

 This option stays active even when you switch off the appliance.

Acoustic signals

The acoustic signals operate when:

- The programme is completed.
- The appliance has a malfunction.

To **deactivate/activate** the acoustic signals, touch the buttons **P** and 🔒 at the same time for 4 seconds.

¹ See in "Settings" how to activate this option.

- i** If you deactivate the acoustic signals, they continue operate when the appliance has a malfunction.

Before first use

1. Put a small quantity of detergent in the compartment for washing phase.
2. Set and start a programme for cotton at the highest temperature without laundry.

This removes all possible dirt from the drum and the tub.

Daily use

WARNING!
Refer to Safety chapters.

Loading the laundry

Open the water tap. Connect the mains plug to the mains socket.

1. Pull the door handle to open the appliance door.
2. Put the laundry in the drum, one item at a time.
3. Shake the items before you put them in the appliance.

Make sure not to put too much laundry in the drum. Refer to max. loads indicated in "Programme chart".

4. Close the door.

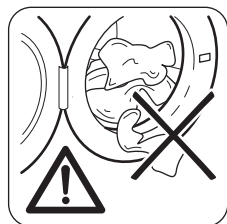

CAUTION!
Make sure that no laundry stays between the seal and the door. There is a risk of water leakage or damage to the laundry.

Using detergent and additives

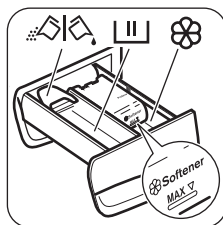

1. Measure out the detergent and the fabric conditioner.
2. Carefully close the detergent drawer.

Detergent compartments

	Detergent compartment for washing phase. If you use liquid detergent, put it immediately before you start the programme.
	Compartment for liquid additives (fabric conditioner, starch). CAUTION! Do not exceed the MAX level.
	Flap for powder or liquid detergent.

Liquid or powder detergent

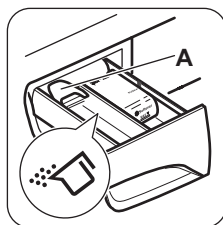

The default position of the flap is **A** (powder detergent).

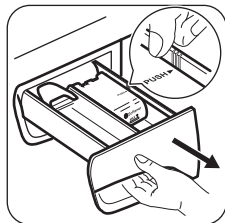

To use liquid detergent:
 1. Remove the drawer. Push the drawer edge in the place with the arrow (PUSH) to remove the drawer easily.

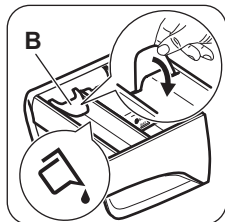

2. Adjust the flap in position **B**.
 3. Put back the drawer in the recess.

- i** When you use the liquid detergent:
- Do not use gelatinous or thick liquid detergents.
 - Do not put more liquid than 120 ml.
 - Do not set the delay start.

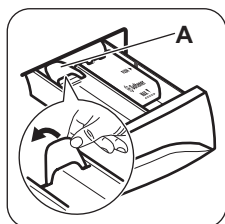

When the flap is in position **B** and you want to use powder detergent:

1. Remove the drawer.
2. Adjust the flap in position **A**.
3. Put back the drawer in the recess.

- Measure out the detergent and the fabric conditioner.
- Put the detergent and the fabric conditioner into the compartments.
- Carefully close the detergent drawer.

Activating the appliance

Press and hold for a couple of seconds the  button to activate or deactivate the appliance. A tune sounds when the appliance is activated. The appliance performs a start up animation. The animation quickly shows each washing programme and the default temperature and spin settings. The display shows the word On.



Setting a programme

1. Touch the programme button **P** and set the programme:
 - The indicator of the button  flashes.
 - The display shows the programme duration.
2. If necessary, change the temperature and the spin speed or add available options. When you activate an option, the indicator of the set option comes on.

i If you set something incorrect, the display shows the message .





Starting a programme without the Finish In option



Touch the button .

- The indicator of the button  stops to flash and stays on.
- The programme starts, the door locks, the indicator  is on.
- The drain pump can operate for a short time at the beginning of the washing cycle.





- i** After approximately 15 minutes from the start of the programme:
- The appliance adjusts automatically the programme duration agree with the laundry load.
 - The display shows the new value.

Starting a programme with the Finish In option

1. Touch the button  again and again to choose the number of hours in which you want the washing cycle to be finished. The display shows the number of hours you set (e.g. ) and the indicator above the button  is on to show that his option is active.
2. Touch the button :
 - The door is locked.
 - The appliance starts the countdown.
 - When the countdown is completed, the programme starts automatically.

i You can cancel or change the set of the Finish In option before you touch the button . After touching the button  you can only cancel the Finish In option.

To cancel the the Finish In option:

- a. Touch the button  to set the appliance to pause. The indicator of button  flashes.
- b. Touch the button  until the indicator above this button goes off.
Touch the button  again to start the programme immediately.

Interrupting a programme and changing the options

You can change only some options before they operate.

1. Touch .

The indicator of this button flashes.

2. Change the options. If you change any option the Finish In option (if set) will be disabled.

3. Touch  again.



The programme continues.

Cancelling a programme

1. Press the button  for some seconds to cancel the programme and to deactivate the appliance.
2. Press the same button again to activate the appliance. Now, you can set a new washing programme.

i The appliance does not drain the water. The water left in a drum can be used for the next washing cycle.

Opening the door





While a programme (or the ) operates, the appliance door is locked. The indicator  is on.







CAUTION!

If the temperature and level of the water in the drum are too high, you cannot open the door.



To open the door during the first minutes of the cycle (or when the operates) :

1. Touch the button  to pause the appliance.
2. Wait until the indicator  goes off.
3. You can open the door.
4. Close the door and touch the button  again. The programme (or the ) continues.





At the end of the programme



- The appliance stops automatically.
- The acoustic signal operates (if it is activated).
- In the display  comes on.
- The indicator of the button  goes off.
- The door lock indicator  goes off.
- You can open the door.
- Remove the laundry from the appliance. Make sure that the drum is empty.
- Press the button  for some seconds to deactivate the appliance.
- Close the water tap.
- Keep the door and the detergent drawer ajar, to prevent the mildew and odours.

The washing programme is completed, but there is water in the drum:

- The drum turns regularly to prevent the creases in the laundry.
- The indicator  flashes to remind you to drain the water.
- The door lock indicator  is on. The indicator of button  flashes. The door stays locked.
- You must drain the water to open the door.

Draining the water:

1. To drain the water.
 - Touch the button . The appliance drains the water and spins with the maximum spin speed for selected washing programme.
 - Alternatively, touch the button  to change the spin speed and then touch the button . The appliance drains the water and spins. If you set , the appliance only drains.



2. When the programme is completed and the door lock indicator  goes off, you can open the door.
3. Press the button  for some seconds to deactivate the appliance.



The appliance drains and spins automatically after approximately 18 hours (except for Wool programme).

AUTO-OFF option

The AUTO-OFF stand-by option automatically deactivates the appliance to decrease the energy consumption. All the indicators and the display go off when :

- You do not use the appliance for 5 minutes before you touch . Press the button  to activate the appliance again.
- After 5 minutes from the end of the washing programme. Press the button  to activate the appliance again. The display shows the end of the last set programme. Touch the button **P** if you want to set a new cycle.

Hints and tips

The laundry load

- Divide the laundry in: white, coloured, synthetics, delicates and wool.
- Obey the washing instructions that are on the laundry care labels.
- Do not wash together white and coloured items.
- Some coloured items can discolour with the first wash. We recommend that you wash them separately for the first times.
- Button up pillowcases, close zippers, hooks and poppers. Tie up belts.
- Empty the pockets and unfold the items.
- Turn inside out multilayered fabrics, wool and items with painted illustrations.
- Remove hard stains.
- Wash with a special detergent heavy soil stains.
- Be careful with the curtains. Remove the hooks or put the curtains in a washing bag or pillowcase.
- Do not wash in the appliance laundry without hems or with cuts. Use a washing bag to wash small and/or delicate items (e.g. underwired bras, belts, tights, etc.).
- A very small load can cause balance problems with the spin phase. If this occurs, adjust manually the items in the tub and start the spin phase again.

Stubborn stains

For some stains, water and detergent is not sufficient.

We recommend that you remove these stains before you put the items in the appliance.

Special stain removers are available. Use the special stain remover that is applicable to the type of stain and fabric.

Detergents and additives

- Only use detergents and additives specially made for washing machines:
 - powder detergents for all types of fabric,
 - powder detergents for delicate fabrics (40 °C max) and woollens,
 - liquid detergents, preferably for low temperature wash programmes (60 °C max) for all types of fabric, or special for woollens only.
- Do not mix different types of detergents.
- To help the environment, do not use more than the correct quantity of detergent.
- Obey the instructions that you find on the on packaging of these products.
- Use the correct products for the type and colour of the fabric, the programme temperature and the level of soil.
- If your appliance has not the detergent dispenser with the flap device, add the liquid detergents with a dosing ball (supplied by the detergent's manufacturer).

Ecological hints

- Set a programme without the prewash phase to wash laundry with normal soil.
- Always start a washing programme with the maximum load of laundry.
- If necessary, use a stain remover when you set a programme with a low temperature.

- To use the correct quantity of the detergent, check the water hardness of your domestic system

Water hardness

If the water hardness in your area is high or moderate, we recommend that you use a water softener for washing machines. In areas where

the water hardness is soft it is not necessary to use a water softener.

To know the water hardness in your area, contact your local water authority.

Use the correct quantity of the water softener. Obey the instructions that you find on the packaging of the product.

Care and cleaning



WARNING!

Refer to Safety chapters.

External cleaning

Clean the appliance only with soap and warm water. Fully dry all the surfaces.



CAUTION!

Do not use alcohol, solvents or chemical products.

Descaling

If the water hardness in your area is high or moderate, we recommend that you use a water softener for washing machines.

Regularly examine the drum to prevent limescale and rust particles.

To remove rust particles use only special products for washing machine. Do this separately from the laundry wash.



Always obey the instructions that you find on the packaging of the product.

Maintenance wash

With the low temperature programmes it is possible that some detergent stays in the drum. Make regularly a maintenance wash. To do this:

- Remove the laundry from the drum.
- Set the cotton programme with the highest temperature with a small quantity of detergent.

Door seal

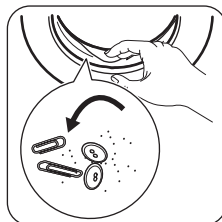

Regularly examine the seal and remove all objects from the inner part.

Cleaning the detergent dispenser

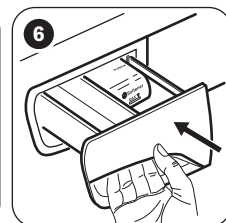
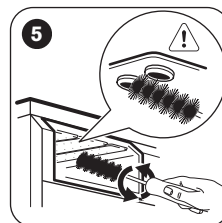
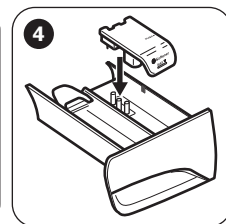
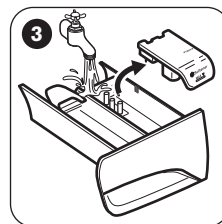
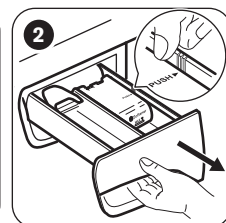

Cleaning the inlet hose and the valve filter

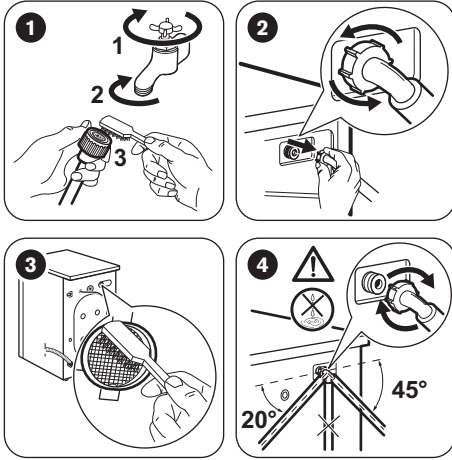

Frost precautions

If the appliance is installed in an area where the temperature can be less than 0 °C, remove the remaining water from the inlet hose and the drain pump.

Troubleshooting



WARNING!

Refer to Safety chapters.

Introduction

The start of the appliance does not occur or it stops during operation.

First try to find a solution to the problem (refer to the table). If not, contact the Authorised Service Centre.

With some problems, the acoustic signals operate and the display shows an alarm code:

- **E10** - The appliance does not fill with water properly.



Do this procedure also when you want to do the emergency drain.

1. Disconnect the mains plug from the mains socket.
2. Remove the water inlet hose.
3. Remove the drain hose from the rear support and unhook it from sink or spigot.
4. Put the ends of the drain and inlet hose in a container. Let the water flow out of the hoses.

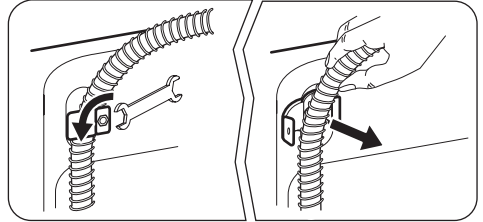

5. When no more water flows, install the inlet hose and the drain hose again.



WARNING!

Make sure that the temperature is more than 0 °C before you use the appliance again. The manufacturer is not responsible for damages caused by low temperatures.

- **E20** - The appliance does not drain the water.
- **E40** - The appliance door is open or not closed correctly. Please check the door!
- **E40** - The mains supply is unstable. Wait until the mains supply is stable.
- **E91** - No communication between electronic elements of the appliance. Switch off and switch on again.



WARNING!

Deactivate the appliance before you do the checks.

Possible failures

Problem	Possible solution
The programme does not start.	<ul style="list-style-type: none"> ▪ Make sure that the mains plug is connected to the mains socket. ▪ Make sure that the appliance door is closed. ▪ Make sure that there is not a damaged fuse in the fuse box. ▪ Make sure that the Start/Pause has been pressed. ▪ If the delay start is set, cancel the setting or wait for the end of count-down. ▪ Deactivate the Child Lock function if it is on.
The appliance does not fill with water properly.	<ul style="list-style-type: none"> ▪ Make sure that the water tap is open. ▪ Make sure that the pressure of the water supply is not too low. For this information, contact your local water authority. ▪ Make sure that the water tap is not clogged. ▪ Make sure that the filter of the inlet hose and the filter of the valve are not clogged. Refer to "Care and cleaning". ▪ Make sure that the inlet hose has no kinks or bends. ▪ Make sure that the connection of the water inlet hose is correct.
The appliance does not drain the water.	<ul style="list-style-type: none"> ▪ Make sure that the sink spigot is not clogged. ▪ Make sure that the drain hose has no kinks or bends. ▪ Make sure that the connection of the drain hose is correct. ▪ Set the drain option if you set a programme without drain phase. ▪ Set the drain option if you set an option which ends with water in the drum. ▪ If above mentioned solutions do not help, contact the Authorised Service Centre (as the filter of the drain pump may be clogged).
The spin phase does not operate or the washing cycle lasts longer than usually.	<ul style="list-style-type: none"> ▪ Adjust manually the items in the tub and start the spin phase again. This problem may be caused by balance problems. ▪ Set the spin option. ▪ Set the drain option if you set an option which ends with water in the drum. ▪ If above mentioned solutions do not help, contact the Authorised Service Centre (as the filter of the drain pump may be clogged).
There is water on the floor.	<ul style="list-style-type: none"> ▪ Make sure that the couplings of the water hoses are tight and there is not water leakages. ▪ Make sure that the water inlet hose and the drain hose have no damages. ▪ Make sure you use the correct detergent and the correct quantity of it.
You cannot open the appliance door.	<ul style="list-style-type: none"> ▪ Make sure that the washing programme is finished. ▪ Set the drain or the spin option if there is water in the drum. ▪ Do the emergency drain procedure. See "Frost precautions" (in "Care and Cleaning" chapter).
The appliance makes an unusual noise.	<ul style="list-style-type: none"> ▪ Make sure the levelling of the appliance is correct. Refer to 'Installation instruction'. ▪ Make sure that the packaging and/or the transit bolts are removed. Refer to 'Installation instruction'. ▪ Add more laundry in the drum. The load may be too small.

Problem	Possible solution
The appliance fills with water and drain immediately.	<ul style="list-style-type: none"> Make sure that the drain hose is in the correct position. The end of the hose may be too low. Refer to 'Installation instruction'.
The cycle is shorter than the time displayed.	<ul style="list-style-type: none"> The appliance calculates a new time according to the laundry load. See the 'Consumption Values' chapter.
The cycle is longer than the time displayed.	<ul style="list-style-type: none"> An unbalanced laundry load increases the duration time. This is a normal behaviour of the appliance.
The washing results are not satisfactory.	<ul style="list-style-type: none"> Increase the detergent quantity or use a different detergent. Use special products to remove the stubborn stains before you wash the laundry. Make sure that you set the correct temperature. Decrease the laundry load.
You cannot set an option.	<ul style="list-style-type: none"> Make sure that you press only the wanted touch button(s).

After the check, activate the appliance. The programme continues from the point of interruption.

If the problem occurs again, contact the Authorised Service Centre.

If the display shows other alarm codes. Deactivate and activate the appliance. If the problem continues, contact the Authorised Service Centre.

Service

We recommend the use of original spare parts.

When contacting the Authorised Service Centre, make sure that these data are available. You can find the information on the rating plate: model (Mod.), PNC (Prod.No.), Serial number (Ser.No.).



Technical Data

Dimension	Width/ Height/ Depth/ Total depth	600 mm/ 850 mm/ 517 mm/ 576 mm
Electrical connection	Voltage Overall power Fuse Frequency	230-240 V 2200 W 13 A 50 Hz
Level of protection against ingress of solid particles and moisture ensured by the protective cover, except where the low voltage equipment has no protection against moisture		IPX4
Water supply pressure	Minimum Maximum	0,5 bar (0,05 MPa) 8 bar (0,8 MPa)
Water supply ¹⁾		Cold water
Maximum Load	Cotton	7 kg
Energy Efficiency Class		A+++

Spin Speed	Maximum	1200 rpm (ZWF 71263W) 1400 rpm (ZWF 71463W)
------------	---------	--

1) Connect the water inlet hose to a water tap with a 3/4" thread.

ENVIRONMENTAL CONCERNS

Recycle the materials with the symbol . Put the packaging in applicable containers to recycle it. Help protect the environment and human health and to recycle waste of electrical and electronic appliances. Do not dispose appliances marked with the symbol  with the household waste. Return the product to your local recycling facility or contact your municipal office.



www.zanussi.com/shop



192974450-A-052014

Free Manuals Download Website

<http://myh66.com>

<http://usermanuals.us>

<http://www.somanuals.com>

<http://www.4manuals.cc>

<http://www.manual-lib.com>

<http://www.404manual.com>

<http://www.luxmanual.com>

<http://aubethermostatmanual.com>

Golf course search by state

<http://golfingnear.com>

Email search by domain

<http://emailbydomain.com>

Auto manuals search

<http://auto.somanuals.com>

TV manuals search

<http://tv.somanuals.com>