

JVC

SERVICE MANUAL

HOME THEATER PROJECTOR

DLA-HD2KU, DLA-HD2KE

DILA

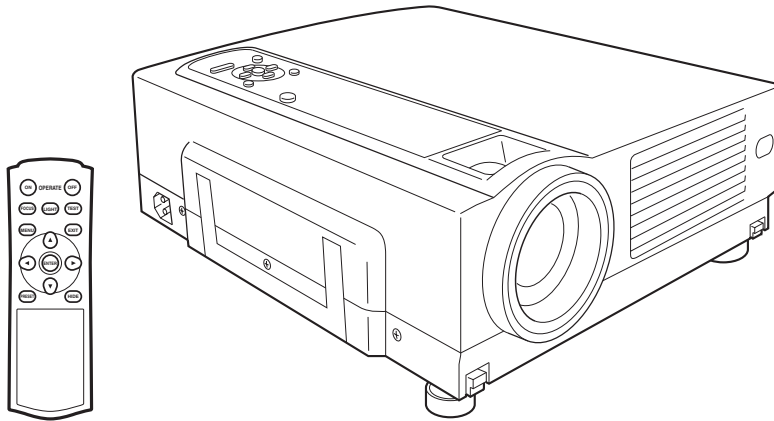

TABLE OF CONTENTS

1	PRECAUTION.....	1-3
2	SPECIFIC SERVICE INSTRUCTIONS.....	1-7
3	DISASSEMBLY	1-13
4	ADJUSTMENT	1-18
5	TROUBLESHOOTING	1-31

SPECIFICATION

■GENERAL

Type	D-ILA HOME THEATER PROJECTOR
Dimensions (W × H × D)	Approx. 298 mm × 134 mm × 360 mm (Approx. 11-7/8" × 5-3/10" × 14-1/5") (Excluding handle, lens and protrusions)
Mass	Approx. 6.2kg (Approx. 13.7lbs)
Power requirements	AC 100-240V 50Hz/60Hz 3.5A (100VAC)~1.4A (240VAC)
Power Consumption	
Operating temperature	+5°~+35°[41°F~95°F]
Operating humidity	20%~80% (no-condensation)
Storage temperature	-10°C~+60°C[14°F~140°F]
Projection angle (Adjustable Foot)	Vertical : max. +6° upper Horizontal : max. 3° (±1.5°)
Remote control unit	RM-MH2KG
operation	Distance : 7m Angle: Horizontal =±30° Vertical =±20°
Mass	100g (includes dry cell battery)
Accessories	Remote control unit (RM-MH2K) × 1 Dry cell battery (size : UM-4/AAA/R02) × 2 DVI Cable (5m) × 1 Power code (2.5m) × 1

■OPTIC

Projection system	D-ILA(reflective activematrix principle)system
D-ILA device	0.82-inch(2.1cm) measured diagonally [H:1920 pixels × V:1080 pixels] × 3 < Total : 6,220,000 pixels >
Projection lens	1.3times (1.8 : 1-2.35 : 1) manual ZOOM lens [50% fix shift]
Screen size	40" (101.6cm) [tele : min]-200" (508cm) < recommended > *measured diagonally with aspect 16:9
Projection distance	approx 1.5m (4.92ft)-12m(39.36ft)
Light lamp	BHL5006-S UHP(Ultra High-Pressue mercury) lamp

■ELECTRIC

Input signal	1080 / 60p signal, 1080 / 50p signal
Resolution	1920 × 1080 dots
Scanning frequency	Horizontal : 56.25kHz,67.43kHz,67.5kHz Vertical : 50Hz,59.94Hz,60Hz
Keystone distortion correction	Top-bottom tilt: Horizontal=about 25°, Vertical=about 5°
Fuse	△QMF51D2-6R3-J1(6.3A)

■OUTPUT TERMINAL

CONTROL	SYNC OUT × 1 stereo mini-jack (For Service)
---------	--

■INPUT CONNECTORS



VIDEO IN	
DVI	DVI-D (single-24pin) terminal HDCP-compatible
CONTROL	Using external computer control
RS-232C	RS-232C protocol D-sub 9-pin × 1
SERVICE	stereo mini-jack × 1 (For Service)

SECTION 1 PRECAUTION

1.1 SAFTY PRECAUTIONS

Prior to shipment from the factory, JVC products are strictly inspected to conform with the recognized product safety and electrical codes of the countries in which they are to be sold. However, in order to maintain such compliance, it is equally important to implement the following precautions when a set is being serviced.

1.1.1 Precautions during Servicing

- (1) Locations requiring special caution are denoted by labels and inscriptions on the cabinet, chassis and certain parts of the product. When performing service, be sure to read and comply with these and other cautionary notices appearing in the operation and service manuals.
- (2) Parts identified by the  symbol and shaded () parts are critical for safety. Replace only with specified part numbers.

NOTE :

Parts in this category also include those specified to comply with X-ray emission standards for products using cathode ray tubes and those specified for compliance with various regulations regarding spurious radiation emission.

- (3) Fuse replacement caution notice.
Caution for continued protection against fire hazard.
Replace only with same type and rated fuse(s) as specified.
- (4) Use specified internal wiring. Note especially:
 - Wires covered with PVC tubing
 - Double insulated wires
 - High voltage leads
- (5) Use specified insulating materials for hazardous live parts. Note especially:
 - Insulation Tape
 - PVC tubing
 - Spacers
 - Insulation sheets for transistors
 - Barrier
- (6) When replacing AC primary side components (transformers, power cords, noise blocking capacitors, etc.) wrap ends of wires securely about the terminals before soldering.

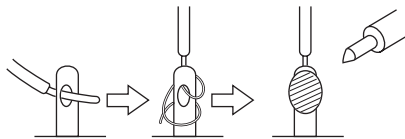

Fig. 1-1-1

- (7) Observe that wires do not contact heat producing parts (heatsinks, oxide metal film resistors, fusible resistors, etc.)
- (8) Check that replaced wires do not contact sharp edged or pointed parts.
- (9) When a power cord has been replaced, check that 10-15 kg of force in any direction will not loosen it.

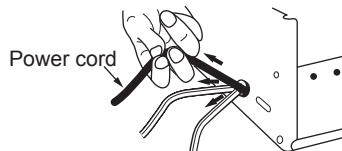

Fig. 1-1-2

- (10) Also check areas surrounding repaired locations.
- (11) Products using cathode ray tubes (CRTs) In regard to such products, the cathode ray tubes themselves, the high voltage circuits, and related circuits are specified for compliance with recognized codes pertaining to X-ray emission.

Consequently, when servicing these products, replace the cathode ray tubes and other parts with only the specified parts. Under no circumstances attempt to modify these circuits. Unauthorized modification can increase the high voltage value and cause X-ray emission from the cathode ray tube.

- (12) Crimp type wire connector In such cases as when replacing the power transformer in sets where the connections between the power cord and power transformer primary lead wires are performed using crimp type connectors, if replacing the connectors is unavoidable, in order to prevent safety hazards, perform carefully and precisely according to the following steps.

- **Connector part number** :E03830-001
- **Required tool** : Connector crimping tool of the proper type which will not damage insulated parts.
- **Replacement procedure**

- a) Remove the old connector by cutting the wires at a point close to the connector. Important : Do not reuse a connector (discard it).

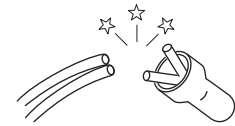

cut close to connector

Fig. 1-1-3

- b) Strip about 15 mm of the insulation from the ends of the wires. If the wires are stranded, twist the strands to avoid frayed conductors.

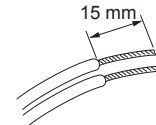

Fig. 1-1-4

- c) Align the lengths of the wires to be connected. Insert the wires fully into the connector.

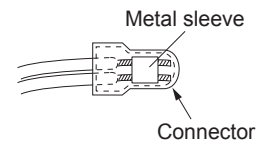

Fig. 1-1-5

- d) As shown in Fig. 1-1-6, use the crimping tool to crimp the metal sleeve at the center position. Be sure to crimp fully to the complete closure of the tool.

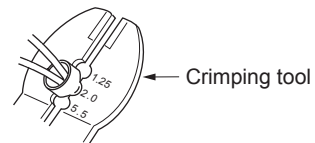

Fig. 1-1-6

- e) Check the four points noted in Fig. 1-1-7.

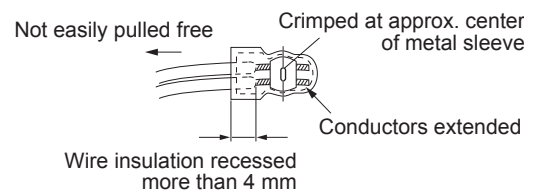

Fig. 1-1-7

1.1.2 Safety Check after Servicing

Examine the area surrounding the repaired location for damage or deterioration. Observe that screws, parts and wires have been returned to original positions. Afterwards, perform the following tests and confirm the specified values in order to verify compliance with safety standards.

(1) Insulation resistance test

Confirm the specified insulation resistance or greater between power cord plug prongs and externally exposed parts of the set (RF terminals, antenna terminals, video and audio input and output terminals, microphone jacks, earphone jacks, etc.). See table 1 below.

(2) Dielectric strength test

Confirm specified dielectric strength or greater between power cord plug prongs and exposed accessible parts of the set (RF terminals, antenna terminals, video and audio input and output terminals, microphone jacks, earphone jacks, etc.). See Fig.1-1-11 below.

(3) Clearance distance

When replacing primary circuit components, confirm specified clearance distance (d), (d') between soldered terminals, and between terminals and surrounding metallic parts. See Fig.1-1-11 below.

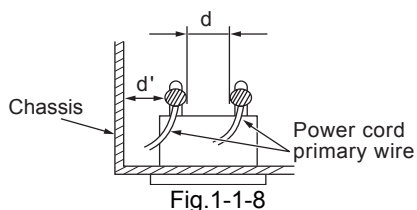

Fig.1-1-8

(4) Leakage current test

Confirm specified or lower leakage current between earth ground/power cord plug prongs and externally exposed accessible parts (RF terminals, antenna terminals, video and audio input and output terminals, microphone jacks, earphone jacks, etc.).

Measuring Method : (Power ON) Insert load Z between earth ground/power cord plug prongs and externally exposed accessible parts. Use an AC voltmeter to measure across both terminals of load Z. See Fig.1-1-9 and following Fig.1-1-12.

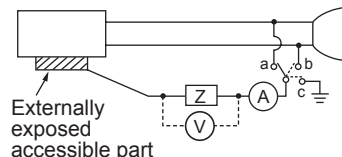
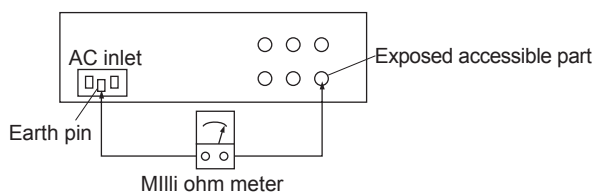

Fig.1-1-9

(5) Grounding (Class 1 model only)

Confirm specified or lower grounding impedance between earth pin in AC inlet and externally exposed accessible parts (Video in, Video out, Audio in, Audio out or Fixing screw etc.). Measuring Method:

Connect milli ohm meter between earth pin in AC inlet and exposed accessible parts. See Fig.1-1-10 and grounding specifications.



Grounding Specifications

Region	Grounding Impedance (Z)
USA & Canada	$Z \leq 0.1 \text{ ohm}$
Europe & Australia	$Z \leq 0.5 \text{ ohm}$

Fig.1-1-10

AC Line Voltage	Region	Insulation Resistance (R)	Dielectric Strength	Clearance Distance (d), (d')
100 V	Japan	$R \geq 1 \text{ M}\Omega/500 \text{ V DC}$	AC 1 kV 1 minute	$d, d' \geq 3 \text{ mm}$
100 to 240 V			AC 1.5 kV 1 minute	$d, d' \geq 4 \text{ mm}$
110 to 130 V	USA & Canada	$1 \text{ M}\Omega \leq R \leq 12 \text{ M}\Omega/500 \text{ V DC}$	AC 1 kV 1 minute	$d, d' \geq 3.2 \text{ mm}$
110 to 130 V 200 to 240 V	Europe & Australia	$R \geq 10 \text{ M}\Omega/500 \text{ V DC}$	AC 3 kV 1 minute (Class II) AC 1.5 kV 1 minute (Class I)	$d \geq 4 \text{ mm}$ $d' \geq 8 \text{ mm}$ (Power cord) $d' \geq 6 \text{ mm}$ (Primary wire)

Fig.1-1-11

AC Line Voltage	Region	Load Z	Leakage Current (i)	a, b, c
100 V	Japan	$1 \text{ k}\Omega$	$i \leq 1 \text{ mA rms}$	Exposed accessible parts
110 to 130 V	USA & Canada	$0.15 \mu\text{F}$ and $1.5 \text{ k}\Omega$	$i \leq 0.5 \text{ mA rms}$	Exposed accessible parts
110 to 130 V 220 to 240 V	Europe & Australia	$2 \text{ k}\Omega$	$i \leq 0.7 \text{ mA peak}$ $i \leq 2 \text{ mA dc}$	Antenna earth terminals
		$50 \text{ k}\Omega$	$i \leq 0.7 \text{ mA peak}$ $i \leq 2 \text{ mA dc}$	Other terminals

Fig.1-1-12

NOTE :







These tables are unofficial and for reference only. Be sure to confirm the precise values for your particular country and locality.

1.1.3 Warning and caution labels

- Labels advising of warning and caution are affixed on and in various locations of the product.
- Take careful notice of these during service and inspection.

 **WARNING** Risk of lethal or otherwise serious personal injury.

 **CAUTION** Risk of personal injury and damage to the product.

Class	Pictorial	Label advisory	Location
⚠ WARNING	Hot, breakable 	This projector lamp emits high heat and contains high-pressure during use. If touched, the lamp (bulb) may rupture and burns may result. Before attempting to replace the lamp, remove the power cord plug from the outlet and wait for the lamp (bulb) to cool (at least one hour). Then proceed to replace the lamp.	Bottom chassis
⚠ WARNING	High voltage 	Never open any cover on the projector except the lamp and filter covers. Dangerous electrical voltage inside the projector.	Bottom chassis
⚠ WARNING	High brightness 	Never look into the lens while the projector is on. There is danger of eye damage.	Top cover
⚠ CAUTION	Hot, shock hazard 	Do not insert foreign objects into the ventilation holes as this can result in fire or electrical hazards. Do not block the ventilation holes as this may cause the internal temperature to rise and possibly result fire. When the inside of the unit requires cleaning, consult your nearest JVC dealer or service center.	Bottom chassis
⚠ CAUTION	High voltage 	Turn off before opening this lamp cover. See user's manual for replacing the lamp. Replace with the same type (BHL5006-S) lamp rated 250W .	Bottom chassis
⚠ CAUTION	Hot 	Caution, high temperature	Lamp unit

1.1.4 Additional cautionary items

- High voltage is applied for lighting the lamp. During adjustments and other work with the cover removed, extreme care is needed to avoid electric shock.
- Use care to avoid touching the fan or safety switch terminals during work with the cover removed.
- Select a stable, horizontal work site to prevent dropping the product and components.
- Use the power cord and interface cable supplied with the product.

Before starting work, be sure to also check the safety notices contained in the instruction manual.

1.2 INSTALLATIONS

1.2.1 Installation method

The D-ILA system (reflecting type active matrix liquid crystal system) does not require convergence adjustment. Note the following when placed on a floor (refer to OPERATING INSTRUCTIONS for actual operating method).

- (1) Place the projector at the position needed for the required image size observe the projector is not tilted horizontally.
[The image size is 40 to 200(wide side) inches diagonal (16:9), requiring a projection distance of 1.58m to 8.03m (wide side).]
- (2) Adjust the placement site and screen tilt so that the projection angle is perpendicular to the screen.
- (3) Adjust the placement site and screen position (height) so that the projection lens center is at the lower edge of the screen.
- (4) Project an image on the screen. (Connect video equipment and power source, switch power on and select the input.)
- (5) Fine adjust the projected image position and angle. If adjusting the placement site and screen cannot correct the projected position (too low) or angle (lower part of image widened), adjust the front foot.
- (6) Turn the lens ZOOM ring by hand and adjust for suitable image size.
- (7) Turn the lens FOCUS ring by hand and adjust to correct image blur.

1.2.2 Installation site and status

- The projector contains a fan for cooling. Obstruction of the ventilation openings can lead to internal overheating, abnormal operation and failure. Also observe there is plenty of free space between the projector and adjacent walls, ceiling and other equipment. Note that excess heat can cause failure and damage to both the projector and nearby equipment.

Required spacing :

Front = 15cm / left and right sides = 30cm / rear = 50cm (When the unit is enclosed with block according to the required spacing on the left side, provide the unit with adequate ventilation so that the temperature inside of the enclosed area is kept at the same temperature in the open space in the room.)

- Avoid locations that are wobbly or inclined. If the setting site floor has protrusions or horizontal cannot be maintained, there is risk the projector may drop, fall over, etc. If located in a site where left to right tilt is greater than $\pm 5^\circ$ and front to rear tilt greater than $\pm 20^\circ$, particularly the optical system components can be severely affected and there is risk basic performance and quality of the projector cannot be maintained.
- Observe the site can stably bear the weight (approx. 6.2kg) of the projector over a long period of time.
- If mounted on a stand with casters, observe the casters are securely braked to prevent movement.
- Avoid suspending in a location subject to vibration. Both the projector and mounting fixture can be damaged.
- Do not place in the following types of locations.
Especially, Avoid locations subject to dust, grit, smoke or other airborne contaminants. Use adequate caution when providing external ventilation, filters and dust protection.

- ◆ Near water or in humid sites
- ◆ Dust or grit
- ◆ Oily or tobacco smokes
- ◆ Near heaters or heat generating equipment
- ◆ Direct sunlight
- ◆ Very high or very low temperature

SECTION 2 SPECIFIC SERVICE INSTRUCTIONS

2.1 FUNCTIONS

2.1.1 LED indications

The LED operations are as follows.

■ OPERATE LED

Lighted : Power on mode in progress.
 Extinguished : Mode other than above.

■ STAND-BY LED

Lighted : Stand-by mode in progress.
 Flashing : Cool down mode in progress.
 Extinguished : Mode other than above.

■ TEMP LED

Flashing : Internal temperature abnormally high
 (shift to emergency mode) .
 Extinguished : Internal temperature normal.

■ LAMP LED

Lighted : Lamp replacement time near (used approx.1900 hours) At power on, message appears by the on-screen display for advising to "LAMP REPLACE".
 Flashing : Lamp end of life (approx. 2000 hours), power on inhibited.
 Extinguished : Mode other than above
 (lamp abnormally absent) .

NOTE :

Please refer to troubleshooting about the warning display by LED.

2.1.2 Operation button & LED location

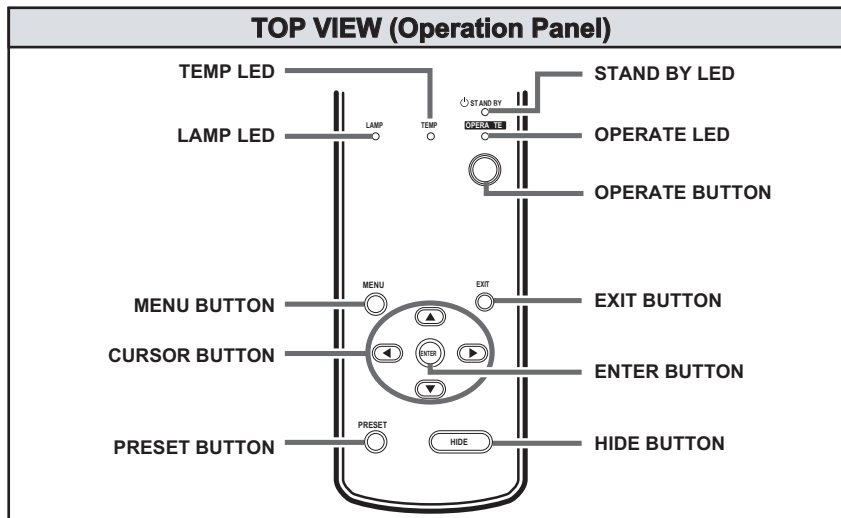

2.1.3 Input / output terminal location

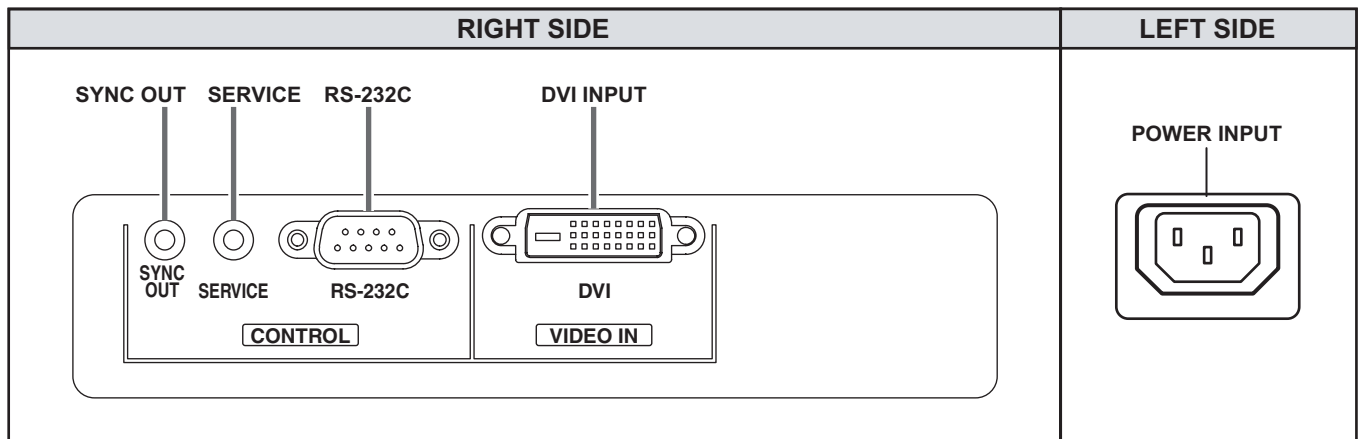

2.2 LAMP UNIT INSTRUCTIONS

Refer to the OPERATING INSTRUCTIONS for a detailed operating description.

2.2.1 Lamp life

Life of the projector lamp (time to reach 1/2 average brightness) is about 2000 hours.

* Lamp use time can be checked at the menu < Information > - [Lamp time].

2.2.2 Operation when lamp use time exceeds 1900 hours

● 1900 to 2000 HOURS

- Power on : LAMP LED lights.
- Operation : "Lamp replacement" message appears on screen (*press any button to extinguish).

● 2000 to 2010 HOURS

- Power on : LAMP LED flashes.
- Operation : "Warning" and "Lamp replacement" messages appear on screen, and "Warning" flashes.
*Press [EXIT] button to extinguish the display. But after 1 hour, "Warning" and "Lamp replacement" again appear.

NOTE:

At power off, the stand-by mode is produced and further operation is prevented.

*To again use the projector, replace the lamp unit and reset the lamp use time indication.

● AFTER 2010 HOURS

- Power on : Power is cut and cool-down mode entered, LAMP and OPERATE LEDs flash.

2.2.3 Handling cautions

- Use a cross-head screwdriver to take out and reinstall the lamp cover (2 screws) and lamp unit (2 screws). Refer to the OPERATING INSTRUCTIONS.
- Observe the following cautions.
 - Be sure to disconnect the power cord from the AC power source.
 - The lamp remains quite hot after power off. Be sure to allow plenty of time (30 minutes to 1 hour) to cool before proceeding.
 - The lamp can break if dropped or subjected to physical shock.
 - Use care not to directly touch or soil the lamp projecting (glass) face.
- When installing the lamp unit, observe the interior projections of the lamp cover are securely inserted into the holes of the projector. Since the lamp cover projections engage the interlock switch part of the protector circuit (normal operating state), be sure the cover is properly positioned and secure with screws.
- The replaced old lamp (depleted lamp unit) can be discarded in the same manner as a fluorescent lamp. Check local ordinances and dispose of the used lamp as prescribed.



2.2.4 Lamp use time reset

- Be sure to reset the Lamp use time after replacing the lamp unit. Unless reset, the projector will cease operation (lamp will not light) when 2000 hours are reached.
*Conversely, reset the use time only after replacing the lamp.
- RESETTING
 - (1) Set for stand-by mode.
 - (2) In sequence, press the [EXIT], [HIDE] and [PRESET] buttons.
 - (3) Press the [\blacktriangle] button for more than 2 seconds.
*The STAND-BY and OPERATE LEDs alternately flash for about 3 seconds, then only the STAND-BY LED lights steadily.
- RESET AFTER REPLACING MAIN PWB ASS'Y
The lamp use time data are stored in memory on the MAIN PWB ASS'Y and need to be reentered after replacing the MAIN PWB ASS'Y. Use the special software and a personal computer to reenter the data. Afterwards, confirm the mode has been returned to that prior to board replacement.

2.3 PROJECTION SPECIFICATIONS AND NOTES

2.3.1 Projection distance

- The usable projection distance (focus obtainable) is tele side : approx. 2.07m to 10.45m / wide side : approx. 1.58m to 8.03m. The picture size (16:9) is 40 to 200 inches.
- Use the wide side for sizes bigger than 200 inches.
- If picture edge distortion occurs at the minimum distance (1.6m), increase the distance slightly.
- The guaranteed projection distance range is from 2m to 10m.

2.3.2 Projection image and image size

- The projection distances and image size relationship given in the operation manual is approximate for general reference. The actual values may vary due to lens tolerance and other factors.

2.3.3 Other cautions

- Use care not to directly touch the lens. Clear soiling from the lens with optical lens paper or a photographer's blower.
- Check the lens cap is removed before projecting. If left installed the projector can overheat and the lens cap can be deformed.
- Sunlight or other illumination can render the image difficult to see. Use a curtain or other means to shield the screen from stray light.

2.4 CONNECTION AND OPERATION CAUTIONS

- The projector can function with fH 56.25kHz, 67.43kHz, 67.5kHz, fV 50Hz, 59.94Hz, 60Hz signal input, but even within this range, partial picture loss, fold-over at the top and bottom picture edges and other effects can occur according to signal type and conditions to prevent a normal projected image (see "Input Sync Frequency" of the OPERATING INSTRUCTION).

2.5 SERVICE POLICY

The following service policy is being utilized.

Item	Parts number	Service method
MAIN PWB ASS'Y	LCA90233-01B	Replace PWB (Some parts are excluded)
DD SUB1 PWB ASS'Y	LCA90234-01B	Replace PWB (Some parts are excluded)
DD SUB2 PWB ASS'Y	LCA90235-01B	Replace PWB (Some parts are excluded)
POWER PWB ASS'Y	LCA10383-01A	Replace parts
IR1 PWB ASS'Y	LCA90271-01B	Replace parts
IR2 PWB ASS'Y	LCA90236-01B	Replace parts
CONT. & 3.3V PWB ASS'Y	SXG-0P002A	Replace parts
OPERATION PWB ASS'Y	LCA90272-01B	Replace parts
OPTICAL BLOCK ASS'Y	HD2KOP-S	Replace (module)
LAMP BALLAST UNIT	QAL0435-002	Replace (module)
LAMP UNIT	BHL5006-S	Replace (module)

2.6 MAIN DIFFERENCE LIST

▲	Part name	DLA-HD2KU	DLA-HD2KE	Remark
	PACKING CASE	LC21468-005A	LC21468-008A	
	POLY BAG	QPA01503005	-----	For Warranty card
	WARRANTY CARD	BT-51030-3	-----	Accessory
▲	POWER CORD	QMPE240-250-R	QMPL280-200-R (for EU) QMPP220-200-R (for UK)	Accessory

2.7 SERVICE MENU

The service menu contains items not ordinarily needed by the user. Use these as necessary during service.

2.7.1 Enter

- (1) No menu shown.
- (2) Press the [\blacktriangle] button.
- (3) Within press the [\blacktriangledown] button.
- (4) Within press the [\blacktriangleright] button.
- (5) Within press the [\blacktriangleleft] button.
- (6) Within press the [ENTER] button to display the service menu.

NOTE:

When the Service Menu Screen is not displayed, go back to the beginning. It is recommended that you press the buttons a little earlier and steadily.

2.7.2 Release

Press the [MENU] button to exit the menu indication.

2.7.3 Basic operation

Use the following buttons to operate the service menu.

- (1) Choose the SETTING MENU with the [\blacktriangle / \blacktriangledown] button.
- (2) When the [\blacktriangleright] button is pressed after choosing the SETTING MENU, the cursor will shift to the SETTING / ADJUSTMENT ITEMS of each SETTING MENU.
- (3) When the cursor is shifted, choose the SETTING / ADJUSTMENT ITEMS with the [\blacktriangle / \blacktriangledown] button.
- (4) Using the [\blacktriangleleft / \blacktriangleright] button, change the setup values and adjustment values, respectively.
- (5) When the [EXIT] button is pressed, the cursor will return to the SETTING MENU.
- (6) When the [MENU] button is pressed, the SERVICE MENU will go out of the screen.

NOTE:

The SERVICE MENU will go out of the screen automatically after 10 seconds if you do not press the [MENU] button.

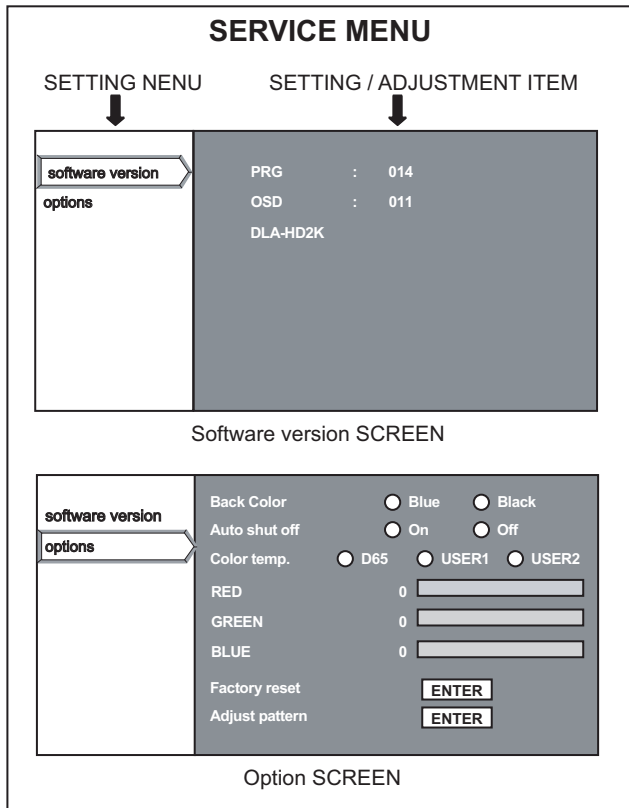

2.7.4 Setting items

Item	Initial value	Adjustment range	Description	Setting object
◆Software version				
Software version	-----	-----	Information of PROGRAM	-----
◆Option				
Back color	Blue	[Select 2 items]	"Sets no signal background color to blue or black. [Blue] : Blue color [Black] :Black color"	Common
Auto shutdown	ON	[Select 2 items]	If POWER OFF is selected, no warning will be displayed on and after 1900 hours of the lamp operating time. However, POWER ON is also available after 2000 hours of the lamp operating time.	Common
Color temp	D65	Select 3 items	Setting of [D65]:6500K, USER1, USER2	Common
R	0	-255~0	Setting color temp of red	Common
G	0	-255~0	Setting color temp of green	Common
B	0	-255~0	Setting color temp of blue	Common
Factory reset	-----	-----	Press [ENTER] then all reset.	Common
Adjust pattern	-----	[Select 5 items]	Press [ENTER] then Test pattern appear. (Refer to following Fig.1)	Common

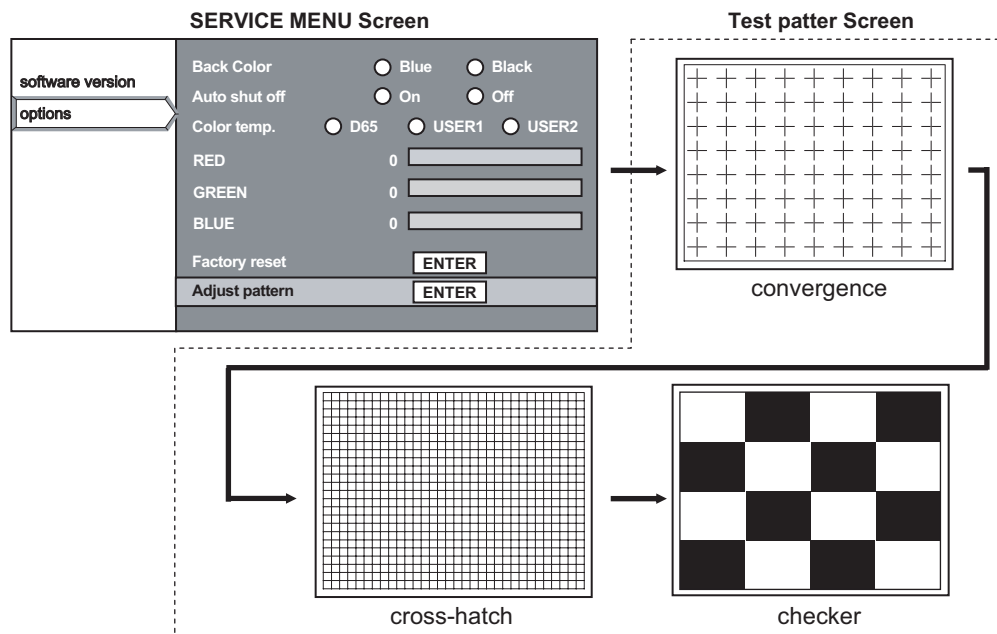

(When the ► key is pressed, the screen is changed one after the other as shown in the above.)

2.8 FACTORY SHIPPING SETTING

● SET (PROJECTOR) / REMOTE CONTROL UNIT

Switch / Item	Position
MAIN POWER	OFF
VIDEO	VIDEO
HIDE	OFF (display)

● MENU

Item	Position
◆ Image adjust	
Gamma	2.2
Color temp.	<input type="text" value="ENTER"/>
Color temp.	D65
RED	0
GREEN	0
BLUE	0
	} This adjustment is only available when the USER is selected for color temperature.
Test pattern	<input type="text" value="ENTER"/>
◆ Set up	
Menu Position	CENTER
Mask	Off
Source	60p

Item	Position
◆ Options	
Menu display	15sec
Flip H	Off
Flip V	Off
Picture Shift	0
Sleep time	Off
RS232C (bps)	19200
◆ Information	
Lamp time	< Lamp usage time >

SECTION 3 DISASSEMBLY

Notes:

- Confirm that the power cord is unplugged from the AC outlet before proceeding.
- The lamp remains quite hot after turning the power off. Allow sufficient time to cool before starting work.

3.1 LENS COVER

- (1) Rotate the LENS COVER on the front of the main frame counterclockwise and release the lock. Then pull out the LENS COVER toward you. (Fig.1)

3.2 LAMP UNIT COVER

- (1) Loosen the 2 screws marked **A** on the right side of the main frame and pull out the LAMP UNIT COVER toward you. (Fig.2)
These 2 screws are not removed from the LAMP UNIT COVER.

3.3 TOP COVER

- Remove the LENS COVER.
 - Remove the LAMP UNIT COVER.
- (1) Remove the 1 screw marked **B** and the 2 screws marked **C** on the right side of the main frame. (Fig.2)
 - (2) Remove the 3 screws marked **D** on the left side of the main frame. (Fig.2)

- (3) Remove the 1 screw marked **E** on the rear side of the main frame. (Fig.2)

- (4) Remove the harness from the connector **CN701** of the CONTROL UNIT which is secured to the back of the TOP COVER.

- (5) Lift up the TOP COVER to remove it.

3.4 PROTECT COVER

- Remove the LENS COVER.
- Remove the LAMP UNIT COVER.
- Remove the TOP COVER.

- (1) Remove the 1 screw marked **E'** fixing the PROTECT COVER, and lift up the PROTECT COVER to remove it. (Fig.2)

3.5 CONTROL UNIT

- Remove the LENS COVER.
- Remove the LAMP UNIT COVER.
- Remove the TOP COVER.

- (1) Remove the 5 screws marked **F** fixing the CONTROL UNIT from the back of the TOP COVER. (Fig.2)

- (2) Remove the CONTROL UNIT. (Fig.2)

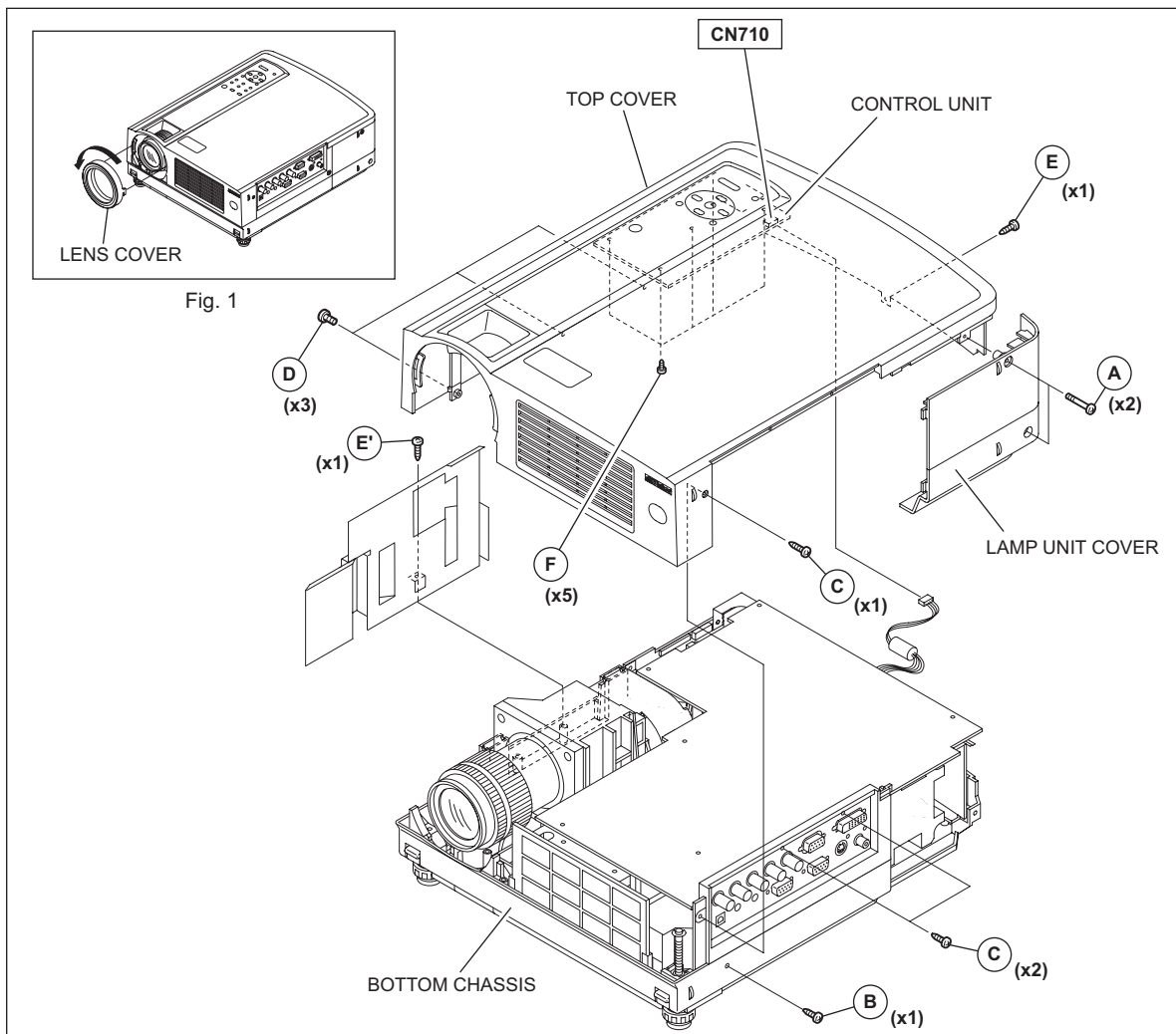

Fig.2

3.6 TERMINAL PWB ASS'Y AND MAIN PWB ASS'Y

- Remove the LENS COVER.
- Remove the LAMP UNIT COVER.
- Remove the TOP COVER.
- (1) Remove the 6 screws marked **J** fixing the MAIN PWB ASS'Y. (Fig.3)
- (2) Remove the harness from the connectors [CN710](#) and [CN711](#).
- (3) Remove the cord wire from the connector [CN504](#) and [CN505](#).
- (4) Remove the harness from the connectors [CN501](#), [CN502](#), [CN503](#), [CN714](#), [CN707](#), [CN706](#), [CN705](#), [CN713](#), [CN704](#) and [CN708](#).

3.7 TERMINAL BOARD AND SHIELD SHEET

- Remove the LENS COVER.
- Remove the LAMP UNIT COVER.
- Remove the TOP COVER.
- Remove the MAIN PWB ASS'Y. *1

- (1) Remove the 4 screws marked **G** fixing the TERMINAL BOARD. (Fig.3)
- (2) Remove the TERMINAL BOARD.
- (3) Using a nut driver and the like, remove the 4 screws marked **H** fixing the D-SUB connector and DVI connector. (Fig.3)
- (4) Pull out the SHIELD SHEET toward you to remove it.

*1

After (2) in the procedure above, the TERMINAL BOARD and the SHIELD SHEET can be replaced. However, be careful about the cord wire and the harness that are not replaced.

3.8 MAIN PWB ASS'Y

- Remove the LENS COVER.
- Remove the LAMP UNIT.
- Remove the TOP COVER.
- Remove the MAIN PWB ASS'Y.
- Remove the TERMINAL BOARD and the SHIELD SHEET.
- (1) Remove the 1 screw marked **K** and the 6 screws marked **J** fixing the MAIN PWB ASS'Y.

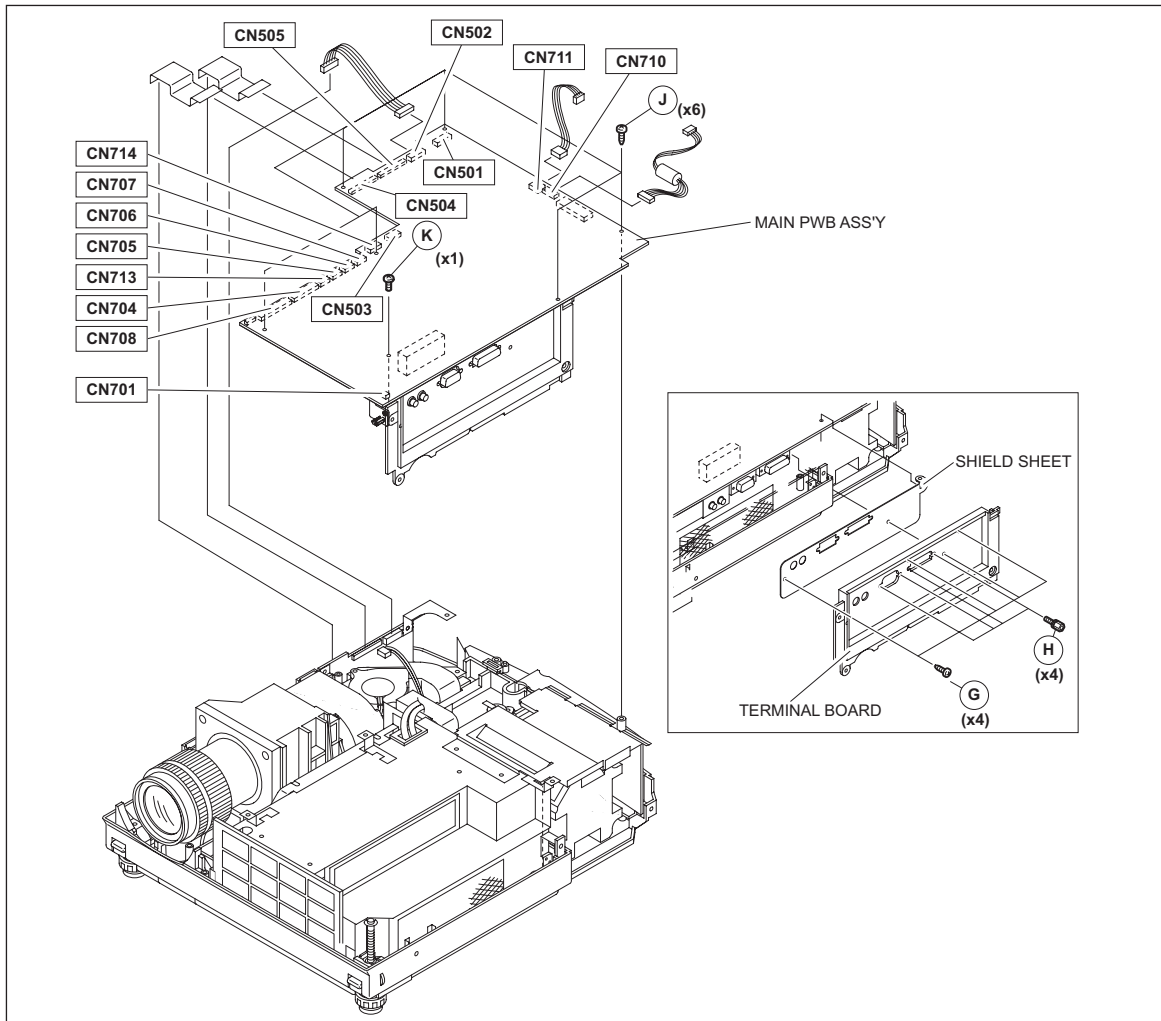

Fig.3

3.9 LAMP UNIT UPPER BRACKET

- Remove the LENS COVER.
- Remove the LAMP UNIT.
- Remove the TOP COVER.
- Remove the MAIN PWB ASS'Y.
 - (1) Remove the 2 screws marked **M** fixing the LAMP UNIT UPPER BRACKET. (Fig.4)
 - (2) Pull out the LAMP UNIT UPPER BRACKET in the direction of the arrow.

3.10 POWER SUPPLY SHIELD CASE(1) and LAMP BALLAST UNIT

- Remove the LENS COVER.
- Remove the LAMP UNIT.
- Remove the TOP COVER.

- Remove the MAIN PWB ASS'Y.
- Remove the LAMP UNIT UPPER BRACKET.
 - (1) Remove the 5 screws marked **N** fixing the POWER SUPPLY SHIELD CASE(1). (Fig.4)
 - (2) Disconnect the connectors **CN1** and **CN2**.
 - (3) Remove the 1 screw marked **O** fixing the LAMP POWER SUPPLY CORD SUPPRESSION BRACKET. (Fig.4)
 - (4) Lift up the LAMP POWER SUPPLY CORD SUPPRESSION BRACKET to remove it, and remove the LAMP POWER SUPPLY CORD.
 - (5) After setting up the POWER SUPPLY SHIELD CASE(1), remove the 4 claws marked **a** which secure the LAMP BALLAST UNIT to the back of the POWER SUPPLY SHIELD CASE. (Fig.4)

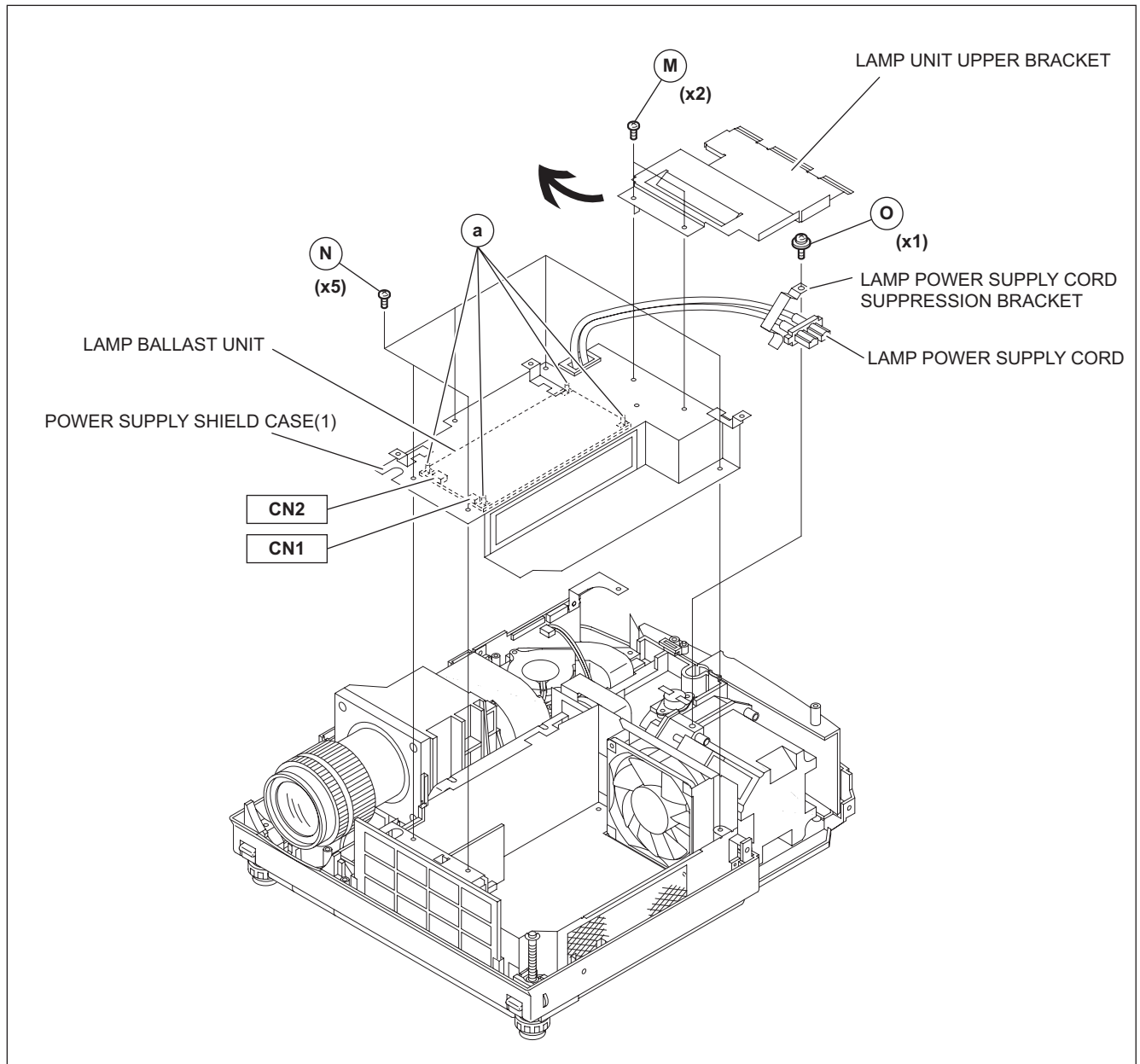

Fig.4

3.11 POWER SUPPLY PWB ASS'Y

- Remove the LENS COVER.
- Remove the LAMP UNIT.
- Remove the TOP COVER.
- Remove the MAIN PWB ASS'Y.
- Remove the LAMP UNIT UPPER BRACKET.
- Remove the POWER SUPPLY SHIELD CASE(1).
 - (1) Remove the 4 screws marked **P** fixing the POWER SUPPLY PWB ASS'Y. (Fig.5)
 - (2) Disconnect the POWER SUPPLY CORD from the connector **CN001**.
 - (3) Pull out the harness from the THERMOSTAT PROTECTOR.
 - (4) Pull out the POWER SUPPLY CONTROL MODULE PWB ASS'Y from CN005. (Fig.5)

3.12 POWER SUPPLY CONTROL MODULE PWB ASS'Y

- Remove the LENS COVER.
- Remove the LAMP UNIT.
- Remove the TOP COVER.
- Remove the MAIN PWB ASS'Y.
- Remove the LAMP UNIT UPPER BRACKET.
- Remove the POWER SUPPLY SHIELD CASE(1).
 - (1) Pull out the POWER SUPPLY CONTROL MODULE PWB ASS'Y from the connector **CN005** of the POWER SUPPLY PWB ASS'Y. (Fig.5)

3.13 POWER SUPPLY SHIELD CASE(2), RADIATION FAN, INTERLOCK SWITCH, COOLING FAN1, DUCT1

- Remove the LENS COVER.
- Remove the LAMP UNIT.
- Remove the TOP COVER.
- Remove the MAIN PWB ASS'Y.
- Remove the POWER SUPPLY SHIELD CASE(1).
 - (1) Remove the 4 screws marked **Q** fixing the POWER SUPPLY SHIELD CASE(2). (Fig.5)
 - (2) Lift up the POWER SUPPLY SHIELD CASE(2) to remove it.
 - (3) Remove the 2 screws marked **R** fixing the RADIATION FAN to the POWER SUPPLY SHIELD CASE(2). (Fig.5)
 - (4) Remove the 1 screw marked **S** fixing the INTERLOCK SWITCH to the POWER SUPPLY SHIELD CASE(2), and remove the INTERLOCK SWITCH. (Fig.5)
 - (5) Remove the 2 screws marked **b** fixing the DUCT1. (Fig.5)
 - (6) Remove the 2 screws marked **c** fixing the COOLING FAN1. (Fig.5)

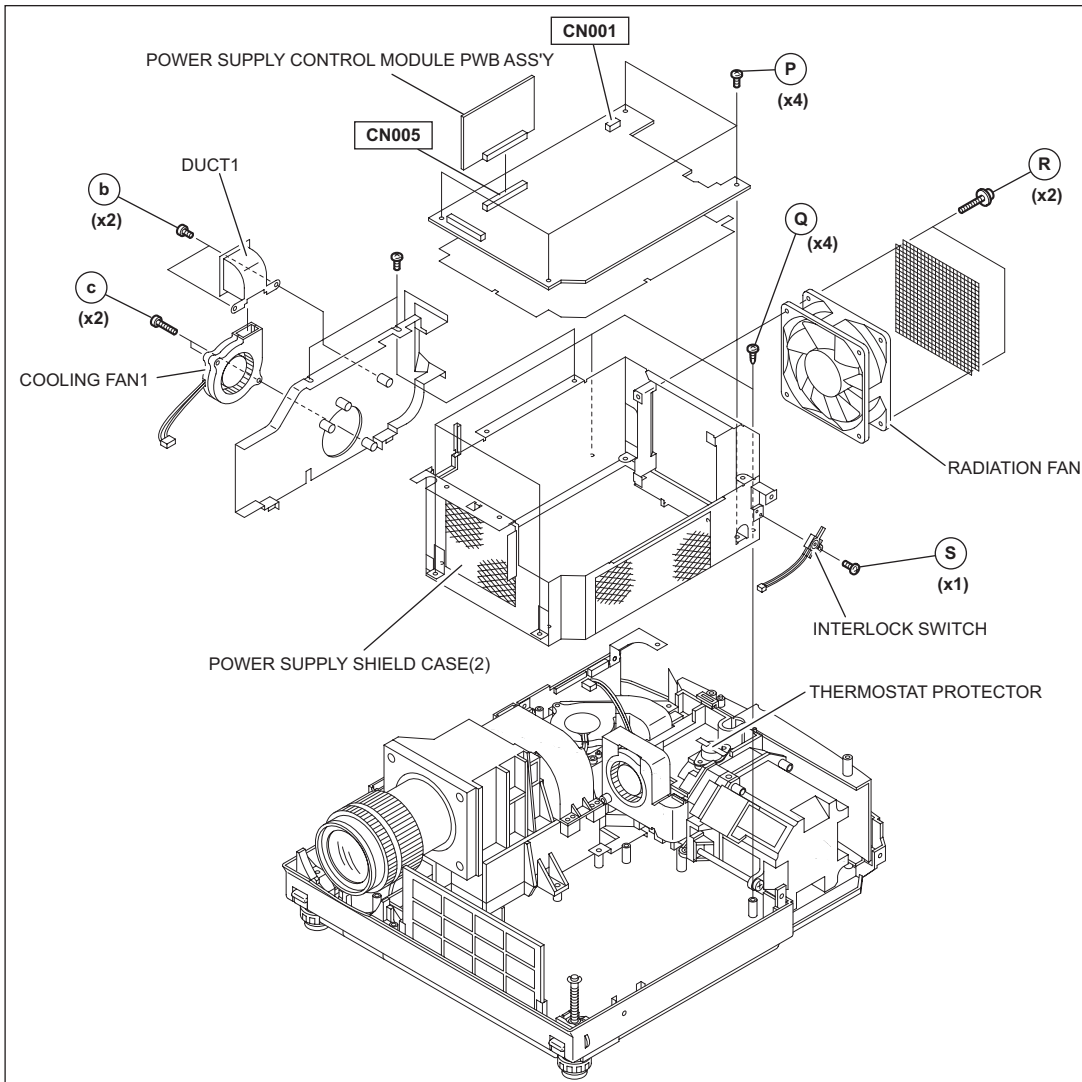

Fig.5

3.14 IR2 PWB ASS'Y

- Remove the LENS COVER.
 - Remove the LAMP UNIT.
 - Remove the TOP COVER.
 - Remove the MAIN PWB ASS'Y.
- (1) Remove the 1 screw marked **T** fixing the IR2 PWB ASS'Y. (Fig.6)
 - (2) Lift up the IR2 PWB ASS'Y to remove it.

3.15 OPTICAL BLOCK, INTAKE FAN

- Remove the LENS COVER.
 - Remove the LAMP UNIT COVER.
 - Remove the TOP COVER.
 - Remove the MAIN PWB ASS'Y.
- (1) Remove the 1 screw marked **o** fixing the LAMP POWER SUPPLY CORD SUPPRESSION BRACKET. (Fig.4)
 - (2) Pull out the LAMP POWER SUPPLY CORD
 - (3) Remove the 2 screws marked **j** fixing the THERMOSTAT PROTECTOR. (Fig.6)
 - (4) Remove the 2 screws **U** and 3 screws **v** fixing the OPTICAL BLOCK. (Fig.6)
 - (5) Remove the 1 screw **k** fixing the EARTH BRACKET that connects the OPTICAL BLOCK and the CHASSIS. (Fig.6)
 - (6) Lift up the OPTICAL BLOCK to remove it. (Fig.6)
 - (7) Remove the 2 screws **d** fixing the INTAKE FAN. (Fig.6)

3.16 DD SUB1 PWB ASS'Y (Incl. DD SUB2 PWB ASS'Y)

- Remove the LENS COVER.
 - Remove the LAMP UNIT.
 - Remove the TOP COVER.
 - Remove the MAIN PWB ASS'Y.
 - Remove the PROTECT COVER.
 - Remove the OPTICAL BLOCK (for easier operation).
- (1) Remove the 3 screws **w** fixing the DD SUB1 PWB ASS'Y. (Fig.6)
 - (2) Remove the cord wire from the connectors [CN007](#), [CN008](#), and [CN009](#).

3.17 COOLING FAN2, DUCT2, COOLING FAN3, DUCT3, DUCT4

- Remove the LENS COVER.
 - Remove the LAMP UNIT COVER.
 - Remove the TOP COVER.
 - Remove the MAIN PWB ASS'Y.
 - Remove the PROTECT COVER.
 - Remove the OPTICAL BLOCK.
- (1) Remove the 2 screws marked **e** fixing the DUCT2. (Fig.6) *2
 - (2) Remove the 2 screws marked **f** fixing the COOLING FAN2. (Fig.6) *2
 - (3) Remove the 3 screw marked **i** fixing the DUCT4. (Fig.6) *2
 - (4) Remove the 1 screw marked **g** fixing the DUCT3. (Fig.6)
 - (5) Remove the 1 screw marked **h** fixing the COOLING FAN3. (Fig.6)

*2

This operation is easier if OPTICAL BLOCK is removed.

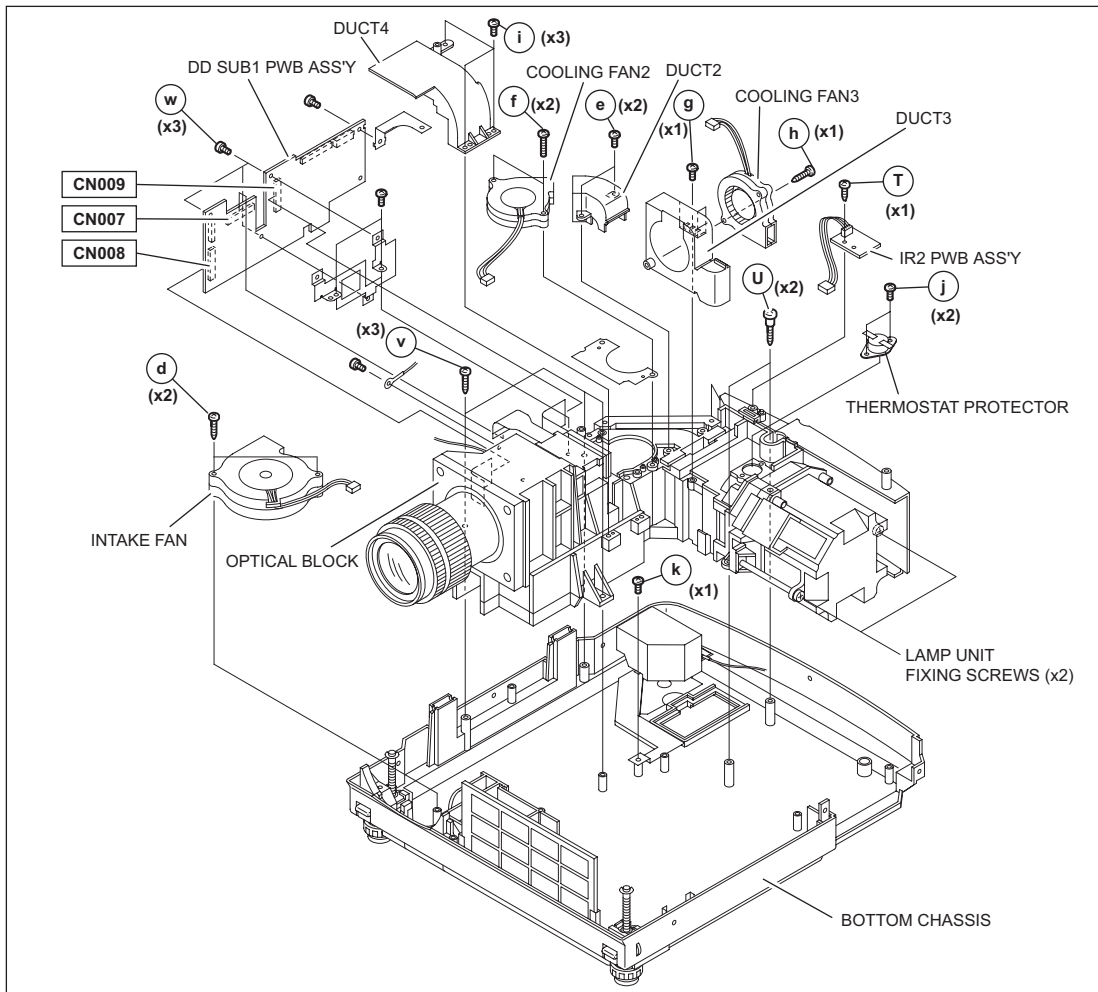

Fig.6

SECTION 4 ADJUSTMENT

4.1 BEFORE STARTING ADJUSTMENT

- (1) Adjustment items utilize a personal computer.
This instruction is for HD2 PSA CONTROL PROGRAM Program. Use the latest version program.
- (2) Data back up is required before adjustments.
- (3) Allow the equipment and test instruments adequate time (at least 30 minutes) to warm-up.
- (4) Confirm the set is properly connected to the specified AC power source.
- (5) Use care not to disturb internal controls and parts not specifically mentioned.
- (6) Unless specifically mentioned in the "ADJUSTMENT PROCEDURE" steps, do not change any data.

4.2 INSTRUMENTS AND TOOLS

- Oscilloscope
- Light meter [for example: Minolta T-10]
- Color-meter [CL-200]
- Remote control unit [RM-MH2K]
- Personal computer

Operating system	Windows 98 ME 2000 XP
Memory	More than 16 Mbytes
Hard disk free space	More than 5 Mbytes
RS-232C interface	At least 1 port
Display resolution	Minimum : 800 × 600 pixels Recommended : 1024 × 768 pixels or better
Display colors	Minimum : 8 bits/pixel Recommended : 16 bits/pixel or better
Input devices	Keyboard and mouse

- Adjustment software : HD2 PSA CONTROL PROGRAM
- RS-232C 9pin NULL-MODEM (cross) cable
- Photoelectric conversion device (one of these)
 - ◆ Light meter [Minolta T-10] A-out (Analog output)
 - ◆ Photoelectric conversion device (for example: HAMAMAT-SU PHOTONICS S1226-8BK)
 - ◆ Phototransistor or CdS photoconductor with amplifier
- Color filters
 - ◆ G color filter (ex. MELLES GRIOT 03 FIV 044)
 - ◆ R color filter (ex. MELLES GRIOT 03 FIB 014)
 - ◆ B color filter (ex. MELLES GRIOT 03 FIV 028)
- Screen
- Darkroom (illumination less than 0.03 lx)

< Use these instruments and tools if necessary >

- NTSC / PAL signal generator : composite output, Y/C output
 - ▼ Gray scale : 0IRE-100IRE
 - ▼ Color bar : include 75% white peak
 - NTSC signal generator : composite output [Y / CB / CR]
 - ▼ Flat (raster) pattern : 10%
 - HDTV signal generator : composite output [Y / PB / PR]
 - Flat (raster) pattern : 10%
 - PC signal generator
 - ◆ Signal : VGA / SXGA
 - ▼ Gray scale : 0.7V (p-p) [include 100% White / 0% Black]
- *Show at least 2 images on 1 screen (Upper scale and Lower scale must be reversed)
- ▼ Cross-hatch
 - ▼ Flat (raster) pattern : 100%, 93%, 13%, 0%

4.3 REQUIRED ADJUSTMENTS BY REPLACING COMPONENTS

The following adjustment procedure is required after replacing PWB ASS'Ys, LAMP BALLAST UNIT and OPTICAL BLOCK. Items noted as "Check" means check the condition, then adjust if required.

4.3.1 Component required adjustment at replacing

Adjustment items	MAIN	DD SUB1.2	POWER	LAMP BALLAST	OPTICAL BLOCK
1. D-ILA COMMON DC	Check	Required	Check	Check	Required
2. DC (GAMMA)	Check	Required	Check	Check	Required
3. GAMMA (GRADATION / WHITE BALANCE)	Check	Required	Check	Check	Required
4. SHADING (UNIFORMITY)	Check	Check		Check	Required
5. 16 - PHASE VERTICAL BARS	Check	Required			Required
6. GHOST		Check			Required
7. FRAME		Check			Required

4.3.2 List of required instruments and tools (except those related to the personal computer)

Adjustment items	OSCILLOSCOPE	Light meter	Color filter	Color meter
1. D-ILA COMMON DC		(Required)		
2. DC (GAMMA)		(Required)		
3. GAMMA (GRADATION / WHITE BALANCE)		Required	Required	Required
4. SHADING (UNIFORMITY)		Required		Required
5. 16 - PHASE VERTICAL BARS	Required			
6. GHOST				
7. FRAME				

4.3.3 Data backup

Before replacing major components such as PWB ASS'Ys, UNIT or BLOCK, be sure to backup the data contained in the set. In absence of data backup, complete adjustment becomes necessary.

● PREPARATION

- (1) Make sure that Version.ini file is located in the same folder of the PSA controller.
- (2) Remove all signal cables except for the interface cable to the PC from the main body.

● DATA SAVE

- (1) Enter Stand-by mode and open the PSA controller on the PC.
- (2) Click [System] in the main menu. When the pull down menu is displayed, click [Backup ROM Data] and open ROM Data Up Load/Down Load.
- (3) Tick [Main EEPROM] and [Sub EEPROM] in [Target EEPROM].
- (4) When [Down Load] is selected, data will be downloaded in the order of EEPROM → EEPROM2 → SUB EEPROM.
- (5) When the download has completed, Save Data with File Name dialog box will be displayed. Then save the data with a file name.

● DATA ENTRY

- (1) Enter Stand-by mode and open the PSA controller on the PC.
- (2) Click [System] in the main menu. When the pull down menu is displayed, click [Backup ROM Data] and open ROM Data Up Load/Down Load.
- (3) Tick [Main EEPROM] in [Target EEPROM].
- (4) When [Down Load] is selected, Open dialog box will be displayed. Then select a file which you want to upload.
- (5) The data will be downloaded in the order of EEPROM → EEPROM2 → SUB EEPROM.

4.4 ADJUSTMENT PROCEDURE

4.4.1 D-ILA COMMON DC adjustment

Instruments	PSA Software for HD2K Oscilloscope Photo sensor	REPLACING COMPONENTS ● DD SUB1.2 PWB ASS'Y ● OPTICAL BLOCK
Test point		
Adjustment menu	< DDIC >	
Preparation	Running the unit enough before adjustment	

Note :

- Large deviation of this adjustment can cause image flicker.
- Residual image or element burn can occur when out of adjustment.

■ PREPARATION

- Connect the PC and the Projector with an RS 232C cable and turn the projector ON.
- Boot the SPA software.
- Click [Connect] in the Menu Bar and select [Auto Connect] in the pull down menu. Refer to Fig.1.

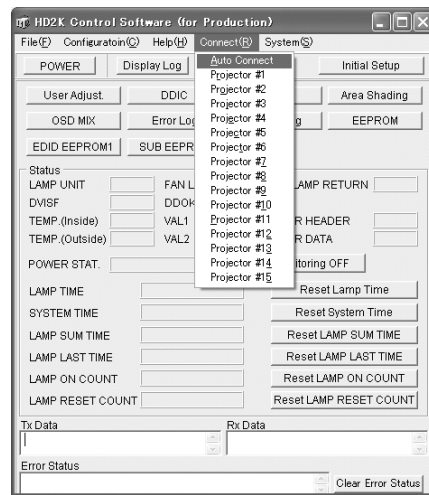

Fig.1

- Press the [DDIC] button in the SPA screen. The DDIC Control screen will be displayed accordingly.
- Press [Receive All] at the top right of the screen.
- Press [R] at the top left of the screen. Set the following buttons located in the furthest right of the screen as follows: Set [GINDAT],[SUPDAT],[DCSDAT] to ON, and the rest to OFF. Refer to Fig.2.

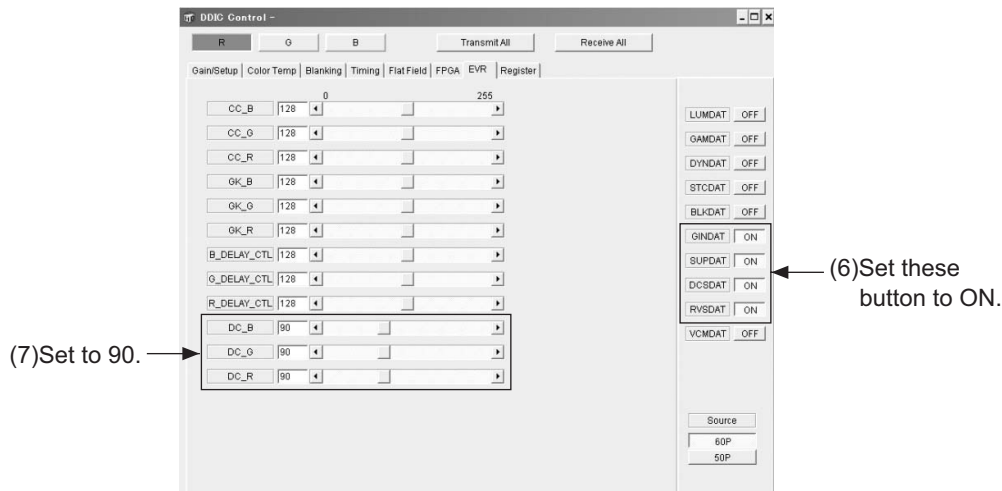

Fig.2

- In the [DDIC] [Control EVR tag] screen, set the value for DC_R, DC_G and DC_B to 90, respectively. Refer to Fig.2.
- Put the photo-sensor at 40 cm away from the surface of the Projector lens (Screen center) and connect the sensor to the oscilloscope.

ADJUSTMENT

(9) On the [DDIC Control][Flat Field] tag, set the Flat Field Level value for a color to be adjusted to 512 and the rest to 0, respectively. Refer to Fig.3.

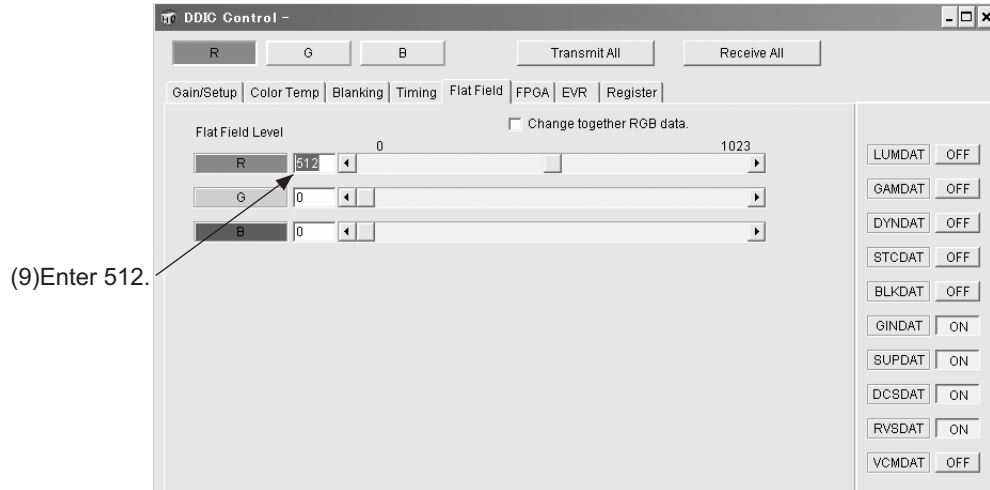

Fig.3

(10) In the [DDIC Control][EVR] tag, find the point by sliding a CC slider (CC_R for red, CC_G for green and CC_B for blue) where the photo-sensor waveform becomes minimum . Refer to Fig.4.

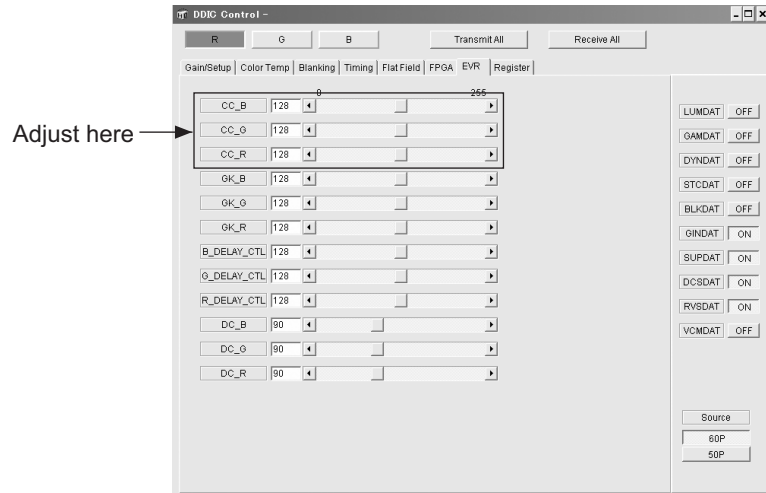

Fig.4

(11) Perform the above procedures (9) and (10) for all colors, R, G, and B.

4.4.2 DC adjustment

Instruments	PSA Software for HD2K Excel file for GAMMA adjustment Color-meter (CL-200)	REPLACING COMPONENTS ● DD SUB1.2 PWB ASS'Y ● OPTICAL BLOCK
Test point		
Adjustment menu	< DDIC > < Gamma >	
Preparation	Running the unit enough before adjustment.	

■ PREPARATION

- (1) Connect the PC and Projector, PC and CL200 with RS-232C cables and then turn the Projector ON.
- (2) Boot the SPA software.
- (3) Click [Connect] on the Menu Bar and select [Auto Connect] in the pull-down menu. Refer to Fig.1.

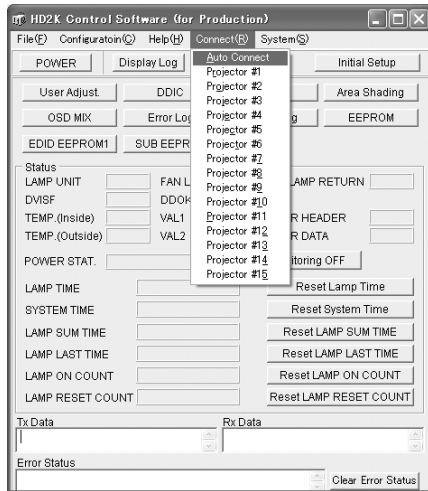
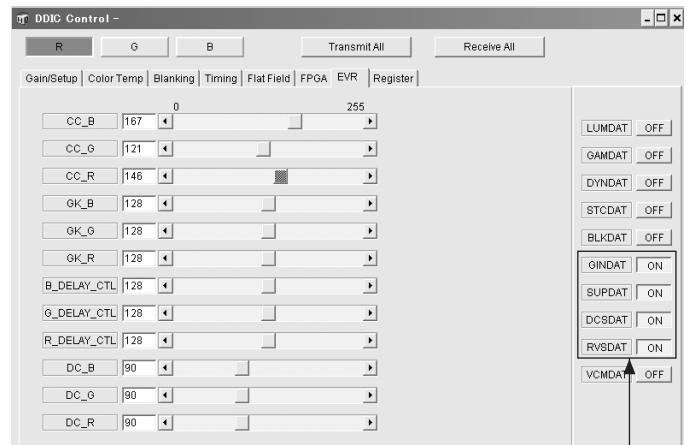

Fig.1



Set these parameters to ON

Fig.2

- (4) When the connection is completed, press the [DDIC] button. The [DDIC Control] screen will appear.
- (5) Press the [Receive All] button at the top right of the screen.
- (6) Press the [R] button at the top left of the screen. Of the buttons located at the furthest right of the screen, set [GINDAT], [SUPDAT][DCSDAT] and [RVSDAT] to ON, and the rest to [OFF].
Refer to Fig.2
- (7) Click [DisConnect] in the PSA menu to disconnect the connection.
- (8) Put the CL200 at 40cm away from the projector lens surface (Screen center) and turn the CL200 to ON.

■ MEASUREMENT

- (9) Open the Gamma adjustment file and click [CONNECT] in the [DC] sheet.
- (10) Click [MEASURE] when [OK] is shown. Refer to Fig.3.

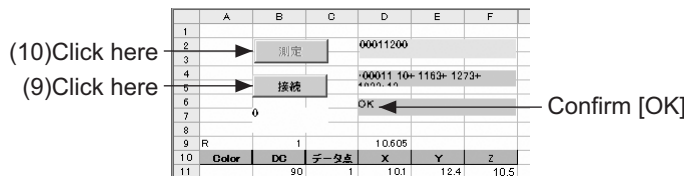

Fig.3

- (11) When the measurement is completed, click [CONNECT] in step 10) to disconnect the system. Boot the PSA software to connect the PC and the Projector.
- (12) On completion of the measurement, enter the values in red in the [D43], [T43] and [AJ43] cells to [DC_R], [DC_G] and [DC_B], respectively.
- (13) Click [DisConnect] in the PSA screen to disconnect the system. The Gamma adjustment is to be performed next.

4.4.3 GAMMA adjustment

Instruments	PSA Software for HD2K Excel file for Gamma adjustment Color-meter (CL-200)	REPLACING COMPONENTS ● DD SUB1.2 PWB ASS'Y ● OPTICAL BLOCK
Test point		
Adjustment menu	< DDIC > < Gamma >	
Preparation	Completed D-ILA COMMON DC adjustment	

■ PREPARATION

- (1) Open the Black (GAMMAOFF) sheet in the GAMMA adjustment file and click [CONNECT] in the same way as the DC adjustment. Refer to Fig.1.
- (2) On completion of the connection, click [MEASURE]. Refer to Fig.1.
- (3) On completion of the measurement, click [CONNECT] again to disconnect the system. Refer to Fig.1.



Fig.1

- (4) Open the E_j calculation sheet in the GAMMA adjustment file (GAMMAOFF_1.0_without color compensation). Click [CREATE FILE] near the BK16 cell and save it with an appropriate file name.
- (5) Connect the PSA and click [Gamma] on the PSA screen.
- (6) Click [CUSTOM] on the Gamma correction screen. Refer to Fig.2.
- (7) Right-click on the Gamma curve in the [Gamma Correction] screen to select [Load CUSTOM Data] and then select the file saved in step 3).
- (8) Click [RGB Transmit All] on the [Gamma correction] screen. Refer to Fig.2.

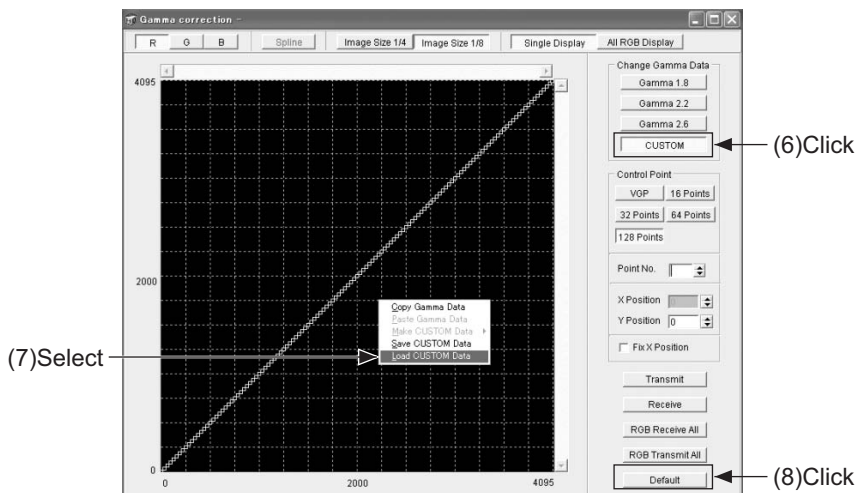

Fig.2

- (9) Click [DDIC] in the SPA menu and set [GAMDAT] to [ON] as shown in Fig.3. Refer to Fig.3.

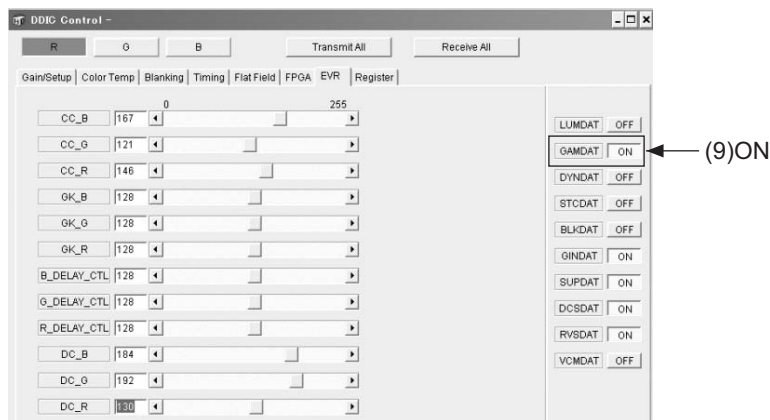

Fig.3

- (10) Click [DisConnect] in the SPA menu to disconnect the system.
- (11) Open the sheet [CHROMATICY MEASUREMENT(RGB)] in the Gamma adjustment file.
- (12) Similarly, click [CONNECT]. Refer to Fig.4.
- (13) When the connection is completed, click [MEASURE]. Refer to Fig.4.
- (14) When the measurement is completed, click [DISCONNECT] to disconnect the system. Refer to Fig.4.
- (15) Confirm if the three graphs shown on the [CHROMATICY MEASUREMENT(RGB)] sheet are linear. If not, the result is determined to be FAILED.



Fig.4

- (16) Open the y calculation sheet in the GAMMA adjustment file (GAMMAOFF_1.0_with color compensation).
- (17) Click [CREATE gcd FILE] near the BK16 cell in the sheet and save it with an appropriate file name.
- (18) Perform the procedures in step 5), 6), 7) and 8). Please note the file to be loaded is the one that is saved in step 17).
- (19) Select the [R] button in the [Gamma correction] screen. Refer to Fig.4.
- (20) Right-click on the Gamma curve in the Gamma correction screen to select [Copy Gamma Data]. Refer to Fig.4.

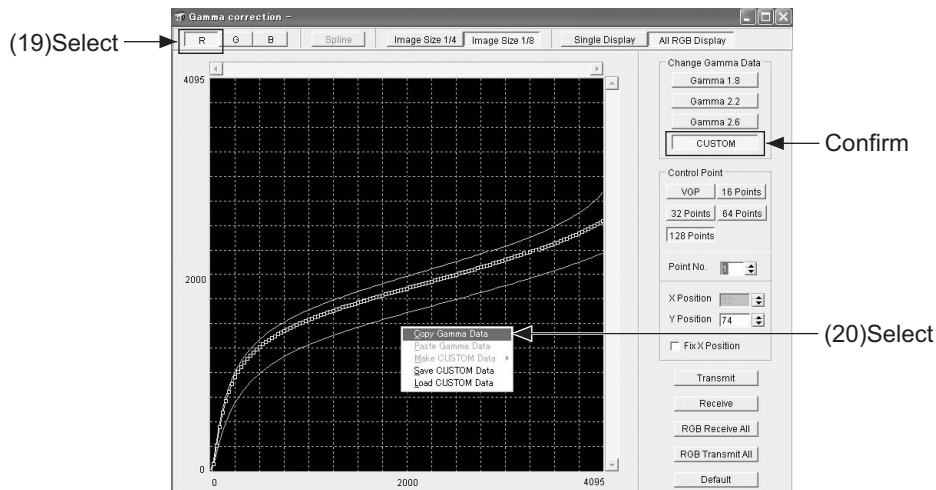

Fig.4

- (21) Select [Gamma2.2] in the [Gamma correction] screen. Refer to Fig.5.
- (22) Right-click on the Gamma curve in the [Gamma correction] screen to select [Paste Gamma Data]. Confirm that the Gamma curve for [R] is pasted. Refer to Fig.5.

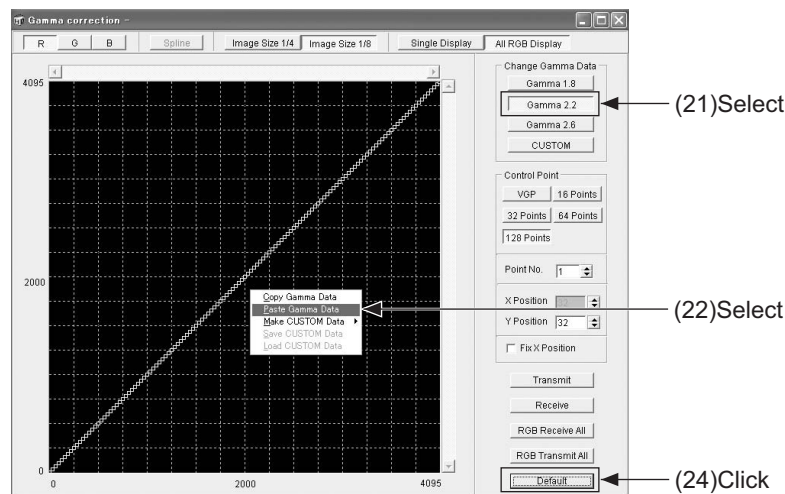

Fig.5

- (23) Perform the procedures in step (19), (20), (21) and (22) for [G] and [B], as well.
- (24) When step (23) is completed, click [RGB Transmit All]. Refer to Fig.5.

(25) Right-click on the [Gamma2.2] curve in the [Gamma correction] screen. Select [Make CUSTOMData] and the [Gamma1.8] to allow the Gamma1.8 data to be input to [CUSTOM]. Refer to Fig.6.

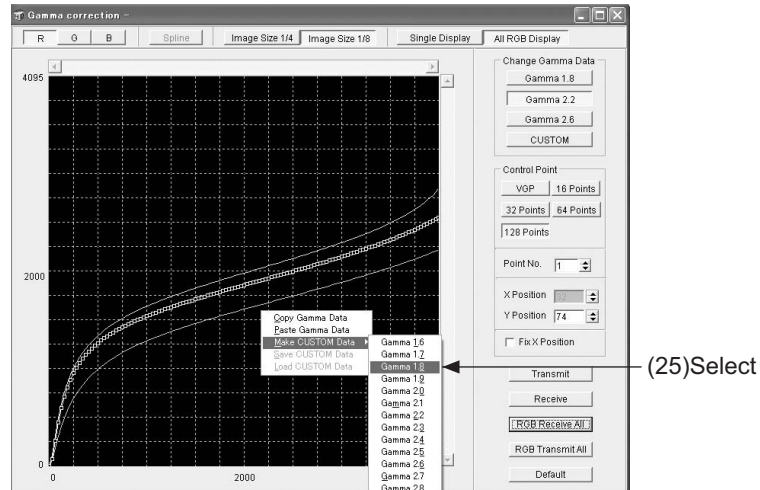

Fig.6

- (26) Copy the [CUSTOM] data, as previously performed in step (19), (20), (21), (22), (23) and (24), to paste these to [Gamma1.8].
- (27) Perform the same procedures as steps (25) and (26) and create the data for Gamma2.6 in [Gamma2.6].
- (28) In [CUSTOM] the same data as Gamma2.2 are to be input. To do this, right click on the Gamma curve in the [Gamma correction][Gamma2.2] screen. Select [Make CUSTOM Data], then [Gamma2.2] to allow the Gamma2.2 data to be input to [CUSTOM].
- (29) Save the Gamma adjustment file and close the file. The Gamma adjustment is now completed.

4.4.4 SHADING adjustment

Instruments	SVGA signal generator Light-meter	REPLACING COMPONENTS ● DD SUB1.2 PWB ASS'Y ● OPTICAL BLOCK
Test point		
Adjustment menu	< DDIC > < Area Shading >	
Preparation	Completed GAMMA adjustment	

■ PREPARATION

- (1) When the reverse shading function is used, open Menu [DDIC] [FPGA], and set [Left side Right] and [Up Side Down] to [Off].
- (2) Open Menu [Area Shading] and, after clicking [LUM]. Set each [R], [G] and [B] to [Default] respectively, then click [Transmit].
- (3) Click [DYN] or [STC] and set [R], [G] and [B] to [Default] respectively in the same way, then click [Transmit].

■ SHADING ADJUSTMENT

- (1) Open Menu [DDIC] [FPGA], and set [R Mute], [G Mute] and [B Mute] to [On].
- (2) Set [R], [G] and [B] Flat Field level to 204, respectively.
- (3) Open Menu [Area Shading] and click [STC]. Then adjust the screen with the slide bar for adjustment level setting so that the screen is evenly colored.
- (4) Open Menu [DDIC] [Flat Field] and set [R], [G] and [B] Flat Field level to 614, respectively.
- (5) Open Menu [Area Shading] and click [DYN]. Then adjust the screen with the slide bar for adjustment level setting so that the screen is evenly colored.
- (6) Open Menu [DDIC], and set [DYNDAT] [STCDAT] to [Off].
- (7) Open Menu [Flat Field] and set [R] Flat Field level to 204, [G] and [B] Flat Field level to 0, respectively. Record the brightness of the screen at this time
- (8) Set [R] Flat Field to 614 and record the brightness of the screen at this time.
- (9) Return [DYNDAT] and [STCDAT] to [On].
- (10) Open Menu [EVR] and adjust [R OFFSET] so that the brightness of the screen become the same value as those of the recorded value.
- (11) Open Menu [DDIC] [Gain/Setup] and click [Gain]. Adjust [DDIC] [GAIN] so that the brightness of the screen at the [R] Flat Field level of 614 become the same value recorded in 8) above.
- (12) In the same manner as for the above steps, also adjust [G] and [B] Flat Field level.
- (13) Adjust [LUM], if necessary. Keep the Flat Field level at 1023 at the center of the screen as much as you can.
- (14) After adjustment, transfer the data to the reverse shading adjustment memory by clicking [Copy Shading Data to Reverse Shading Data] on the bottom of the Area Shading screen. At this time, open [Shading] on [Configuration] tool bar and set the values according to the table on the right side so as to compensate the vertical reverse shading gradient.

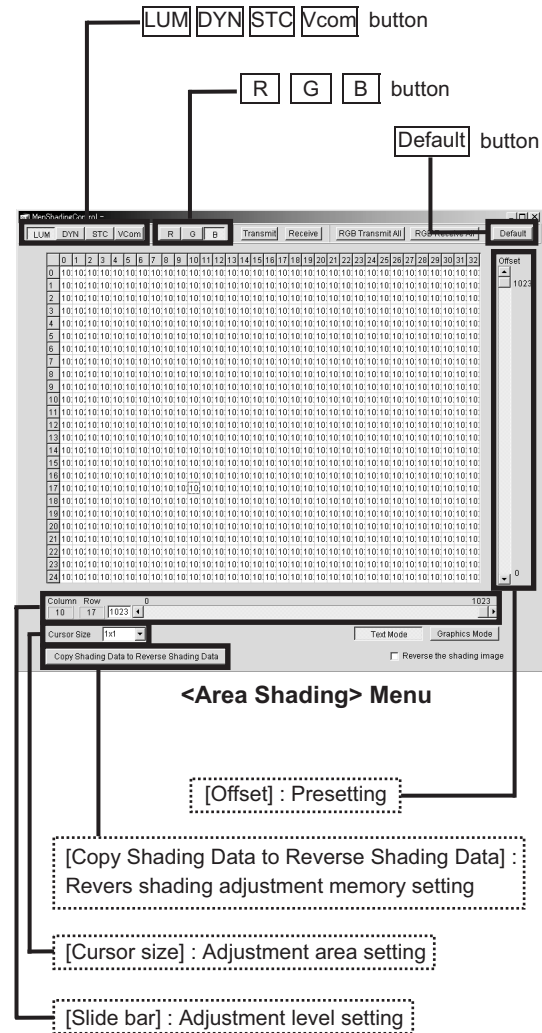

	STC Shading	DYN Shading
Red	63	0
Green	63	0
Blue	63	0

< Compensate the vertical reverse shading gradient >

*If necessary, adjust Up Side Down position. When adjusting the Up Side Down position, hang the unit from the ceiling. Open Menu [DDIC] [FPGA] and set [Left Side Right] and [Up Side Down] to [On]. For the adjustment, follow the same manner as for the steps (1)~(14) above.

4.4.5 16-PHASE VERTICAL BARS adjustment

Instruments	PSA Software for HD2K Phase deviation measurement circuit Phase deviation measurement Excel file	REPLACING COMPONENTS ● OPTICAL BLOCK ● DD SUB1.2 PWB ASS'Y
Test point		
Adjustment menu	< DDIC >	
Preparation	Completed GAMMA adjustment	

■ PREPARATION

- (1) Connect the Phase Deviation Measurement circuit at CN005 with the Projector turned off. Connect the FPC to a desired color.
- (2) Connect the PC and Projector with a RS232C cable. Turn the projector ON and boot the SPA software.
- (3) Click [Connect] on the menu bar and select [Auto Connect] in the pull-down menu. Refer to Fig.1. (If [Connection failed] is shown, the connection is FAILED. If no message appears, the connection is completed and the result is PASSED)

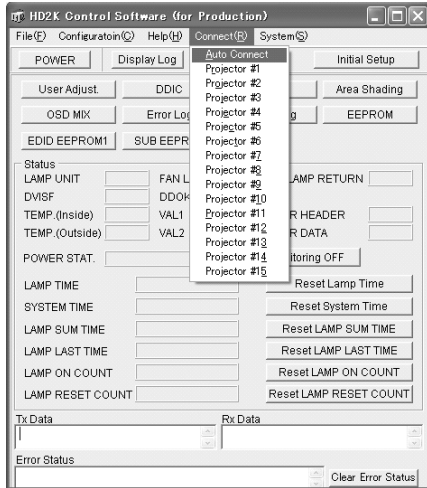

Fig.1

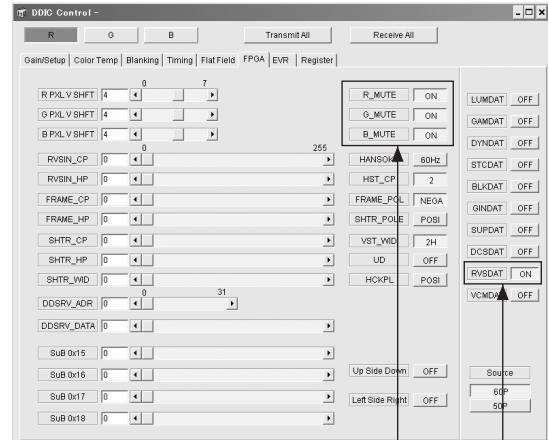
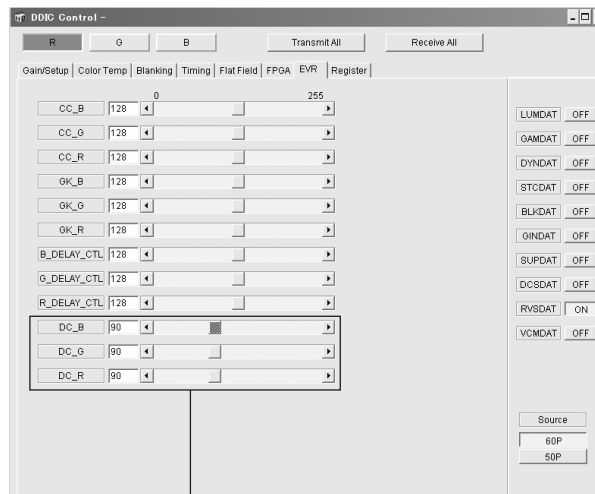

Fig.2

- (4) When the connection is made, press [DDIC]. The DDIC Control screen will appear.
- (5) Click [Receive All] at the top right of the screen.
- (6) Press [R] at the top left of the screen.
- (7) Of all buttons located at the furthest right of the screen, set [RVSDAT] to [ON] and the rest to [OFF]. Refer to Fig.2.
- (8) Repeat the procedure in step (7) for the [G] and [B] buttons.
- (9) Click the [EVR] tag in the DDIC Control screen.
- (10) Set the values for [DC_R], [DC_G], [DC_B] to 90. Refer to Fig.3.



(10)Set these parameters to 90

Fig.3

- (11) Press the [Load File] button in the [Register] tag in the DDIC Control screen.
- (12) Select [PHS_RGBch_Inter-Phase Deviation_Clear.txt] and press [OK] in the [CONFIRM] message box.
- (13) Set [R_MUTE], [G_MUTE], [B_MUTE] to ON in the [DDIC Control][FPGA] tag.
- (14) Copy the entire contents of the [HD2K_16 Phase Adjustment_XX . Xls] file and modify the xxx to a serial number.

MEASUREMENT

- (1) Open the previously renamed Excel file and select the [PHS_Rch] sheet.
- (2) Set the values of the [R], [G] and [B] scroll bars to [0] in the [DDIC Control][Flat Field] tag in the [DDIC Control] screen.
- (3) Set the slide switch to [FORWARD] on the Phase Deviation Measurement circuit.
- (4) Connect the Phase Deviation Measurement circuit probe to the 1st Phase pin, a header pin on the PCB to which the FPC is connected. Enter the value measured on the Digital Voltmeter without a minus sign to [FORWARD ROTATION] [Black] [1], or the [B3] cell in the Excel file. Refer to Fig.4.

	A	B	C	D	E
1					
2		Black	White	Center	
3	1	6.031	2.299	6.031	
4	2			0.000	
5	3			0.000	
6	4			0.000	
7	5			0.000	
8	6			0.000	
9	7			0.000	
10	8			0.000	
11	9			0.000	
12	10			0.000	
13	11			0.000	
14	12			0.000	
15	13			0.000	
16	14			0.000	
17	15			0.000	
18	16			0.000	
19		0	0	6.130	
20				0.37691	
21		Black	White		
22					
23	1	6.19	9.375		
24	2				
25	3				
26	4				
27	5				
28	6				
29	7				
30	8				
31	9				
32	10				
33	11				
34	12				
35	13				
36	14				
37	15				
38	16				
39		0	0		
40				5.671	
41				*****	
42				90.000	
43				100.000	
44				10.000	
45					
46					

Fig.4

- (5) Connect the probe to the 2nd Phase pin and enter the measured value to [B4]. Perform the procedure stated in step (4) through to the 16th phase.
- (6) Set the slide switch on the Phase Deviation Measurement circuit to [REVERSE ROTATION].
- (7) Connect the probe of the Phase Deviation Measurement circuit to the 1st Phase pin, a header pin to which the FPC is connected. Enter the value measured on the Digital Voltmeter without minus sign to [REVERSE ROTATION] [Black] [1], or the [B23] cell in the Excel file. Refer to Fig.4.
- (8) Connect the probe to the 2nd phase and enter the measure value to [B24]. Repeat the procedure from step (7) through to the 16th phase.
- (9) Of the [R], [G] and [B] in the [Flat Field]tag, set the scroll bar value of the color to be measured to [1023].
- (10) Set the slide switch on the Phase Deviation Measurement circuit to [FORWARD].
- (11) Connect the Phase Deviation Measurement circuit probe to the 1st phase pin, a header pin on the PCB to which the FP1C is connected. Enter the value measured on the Digital Voltmeter without a minus sign to [FORWARD ROTATION] [White] [1], or the [C3] cell in the Excel file. Refer to Fig.4.
- (12) Connect the probe to the 2nd Phase pin and enter the measured value to [C4]. Repeat the procedure through to the 16th phase.
- (13) Set the slide switch on the Phase Measurement circuit to [REVERSE].
- (14) Connect the Phase Deviation Measurement circuit probe to the 1st phase pin, a header pin on the PCB to which the FPC is connected. Enter the value measured on the Digital Voltmeter without a minus sign to [REVERSE ROTATION] [White] [1], or the [C23] cell in the Excel file. Refer to Fig.4.
- (15) Connect the probe to the 2nd Phase pin and enter the measured value to [C24]. Repeat the procedure through to the 16th phase.
- (16) In the [Flat Field][DDIC Control] screen, set all the [R], [G] and [B] scroll bar values to [0].
- (17) Set [DCSDAT] of the color under measurement to [ON]. Enter the value measured on the Digital Voltmeter without a minus sign to the cell [B40] in the Excel file. Refer to Fig.4.
- (18) Press the [CREATE FILE] button located in [C42] in the Excel file. Refer to Fig.4.
- (19) Press the [Load File] button in the [DDIC Control][Register] tag. If the Rch measurement is performed, select the [C:\FHD\~~~.txt] file and press [OK] in the [CONFIRM] message box. Be sure to modify the xxx in the file name to a serial number.
- (20) Set [GINDAT], [SUPDAT], [DCSDAT] and [RVSDAT] to [ON]. Refer to Fig.4.
If the measured voltage differences on Phase 1 through to Phase 16 in the Phase Deviation Measurement circuit are within +/-10 mV, the result is determined to be PASSED.
If the result is outside this range, the result is determined to be FAILED.
- (21) Turn the Projector OFF.
- (22) Perform the procedures from step (9) for Gch and Bch.

4.4.6 GHOST adjustment

Instruments	PSA Software for HD2K	REPLACING COMPONENTS ● OPTICAL BLOCK
Test point		
Adjustment menu	< DDIC >	
Preparation	Completed GAMMA adjustment , SHADING adjustment ,	

■PREPARATION

- (1) Connect the PC and Projector with a RS-232C cable and turn the Projector ON.
- (2) Boot the PSA software.
- (3) Click [Connect] on the menu bar and select [Auto Connect] in the pull-down menu.
Refer to Fig.1.

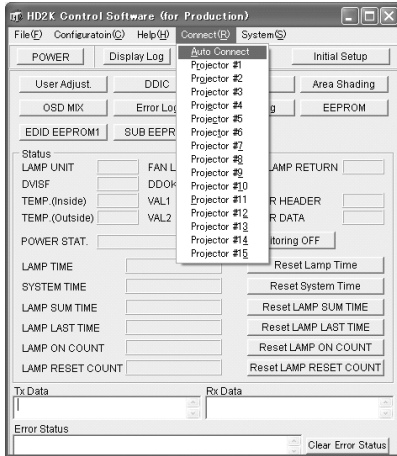
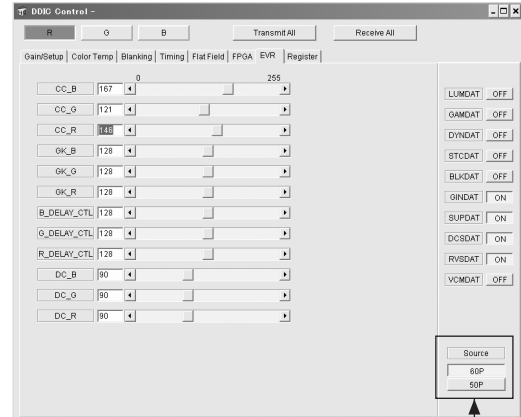

Fig.1



(6)Select 60p

Fig.2

- (4) When the connection is completed, press [DDIC]. The [DDIC Control] screen will appear.
- (5) Press the [Receive All] button located at the top right of the screen.
- (6) Click the [EVR] tab and then click [60P] as shown in Fig.2.

■MEASUREMENT

- (7) Press the [TEST] button on the remote control unit to display the grey scale of [R] (Color to be adjusted).
- (8) Using the [DDIC Control][EVR] tab, adjust [R_DELAY_CTL] (Refer to Fig.2) to allow the reflection to be minimum.
- (9) Perform the procedures in steps (7) and (8) for [G] and [B].
- (10) When the procedure in step (9) is completed, click [50P] in the [EVR] tab and then click [Receive All].
- (11) Perform the procedures in items (7), (8) and (9).

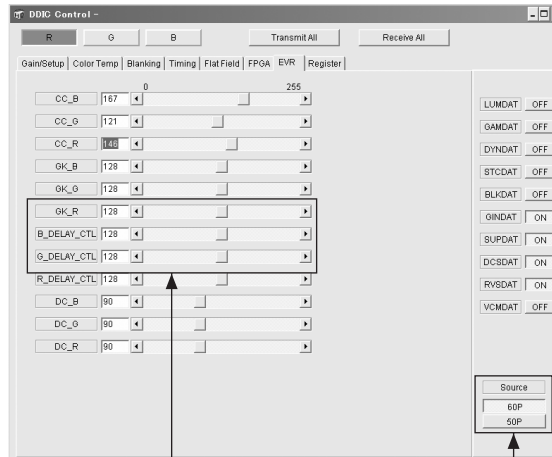

(8)Adjust these parameters.

(10)Select 50p

Fig.3

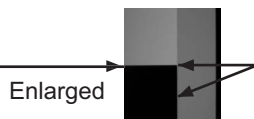

Adjust to minimize the reflection by monitoring the left and right portions of the boundary.

Fig.4

4.4.7 FRAME adjustment

Instruments	Signal generator	REPLACING COMPONENTS ● OPTICAL BLOCK
Test point		
Adjustment menu	< DDIC >	
Preparation	Completed GAMMA adjustment , SHADING adjustment ,	

■PREPARATION

- (1) Connect the PC and Projector with an RS-232C cable. Turn the Projector ON and boot the PSA software.
- (2) Click [Connect] on the Menu Bar and select [Auto Connect] in the pull-down menu.
Refer to Fig.1. (If [Connection failed] is shown, the connection is FAILED. If no message appears, the connection is successfully done.

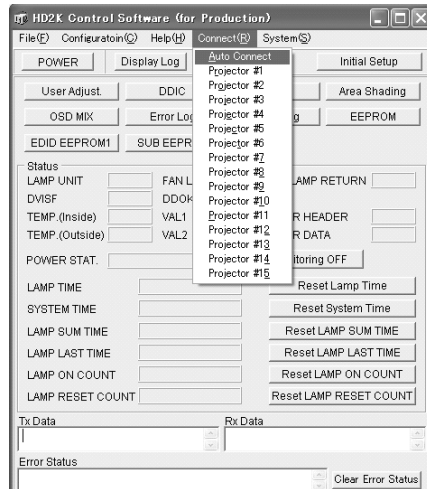

Fig.1

- (3) When the system is connected, press the [DDIC] button. This causes the [DDIC Control] screen to be displayed. Subsequent works are to be performed on this screen.
- (4) Press the [Receive All] button at the top right of the screen.
- (5) Set [R_MUTE], [G_MUTE] and [B_MUTE] to ON with the [FPGA] tab.
- (6) Set Flat Field Level of R, G, and B to all [0]. (All black)

■ADJUSTMENT

- (1) Move the slider of [GK_R], [GK_G] and [GK_B] with the [EVR] tab to allow the picture frame to be darkened most. Refer to Fig.2.

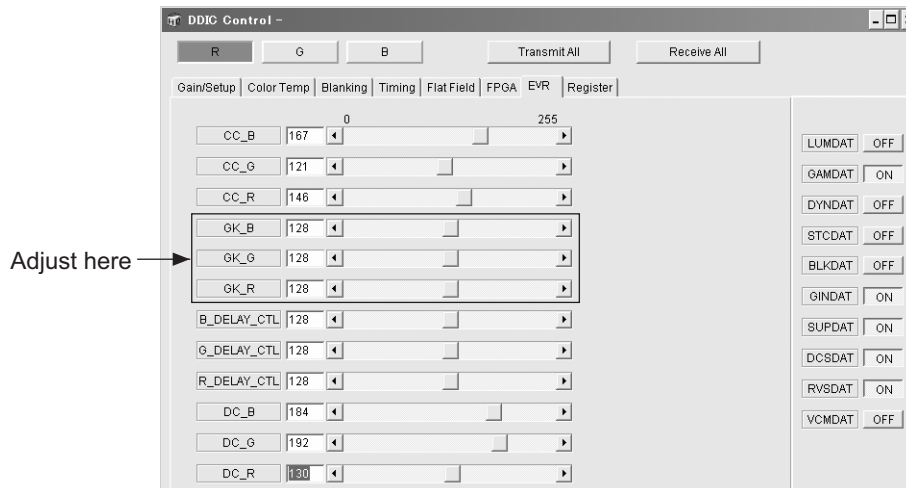

Fig.2

SECTION 5 TROUBLESHOOTING

5.1 PROTECTIVE SENSOR AND PROTECTIVE SWITCH

In event of abnormal operation due to circuit or component failure, setting error or other reason, in order to prevent serious damage to the set and preserve the integrity of peripheral equipment, sensors and switches are provided for protective functions. Cooling is conducted at the same time a corresponding LED flashes (about 90 seconds). The LED indication with respect to the protective function is described below.

5.1.1 Protective sensor

Type	Monitor objective	Location	Operating point	Function
Thermal sensor (Thermostat)	Lamp unit	Optical block (Lamp section)	140°C	AC line (one side) open
Thermal sensor (IC)	Set interior (Lamp area)	MAIN PWB ASS'Y IC728	70°C	Power off by main CPU (emergency mode)
Thermal sensor (IC)	Set exterior (Filter area)	MAIN PWB ASS'Y IC727	62°C	Power off by main CPU (emergency mode)
Motor operation detection circuit	Cooling fan	Cooling fan interior	Fan stop	Power off by main CPU (emergency mode)

5.1.2 Protective switch

Type	Monitor objective	Location	Operating point	Function
Interlock switch	Lamp cover	Optical block (Lamp section)	Switch open	Control by CPU

5.2 LED (INDICATOR) WARNING INDICATIONS

5.2.1 Led indication contents

If an abnormality occurs during operation (projection), the content of the problem can be determined from flashing LED indicators. When an LED indicates, operation (projection) automatically stops and the cool-down mode (about 90 seconds) is entered (except for No.1, No.3, No.4, No.5 and No.6), then the stand-by mode.

No.	Flashing LED				Flash time	Warning cause (projector mode)
	LAMP	TEMP	STAND BY	OPERATE		
1	●		●		0.5sec.	Lamp not lighted cannot project
2	●			●	0.5sec.	Lamp extinguishes during projection Lamp use time exceeds 2010 hours
3	×			×	0.5sec.	Lamp terminal not contact
4	●	●			0.5sec.	Sub CPU circuit error
5	●	●			0.25sec.	Device drive circuit error
6	×	×			0.5sec.	Video process circuit (decoder) error
7	×	×			0.25sec.	Video system error after data initializing
8		●			0.5sec.	Set interior abnormally hot
9		●	●		0.5sec.	Air intake temperature too high (exterior temperature abnormal)
10	●	●	●	●	0.5sec.	Set internal cooling fan stopped (fan locked)
11	●				0.5sec.	Lamp use time exceeds 2000 hours

● : Flashing together × : Flashing alternately

5.2.2 Measures during abnormality

In event of the following be sure to disconnect the power cord from the AC outlet, and reset the projector mode.

No.	Abnormality	Mode	Measure	Mode	Cause
1	Lamp dose not light	→	Again supply power (press OPERATE button)	OK	Lamp lighting failure
		NG	Check lamp use dose not exceed 2000 hours	YES	Lamp use inhibited
		NG	Replace lamp unit	OK	Lamp defective
		NG	Replace LAMP BALLAST unit	OK	Igniter circuit faulty
2	Lamp extinguishes during projection	→	Revise installation mode (protect from shock, vibration, etc)	OK	Installation mode (environment) unfavorable
		NG	Replace lamp unit	OK	Lamp defective
	Lamp use time exceeded	→	Replace lamp and reset the lamp use time	OK	Lamp use inhibited
3	Sub CPU operation faulty	→	Again supply power (press MAIN POWER button)	OK	Circuit operating error
		NG	Replace MAIN PWB ASS'Y	OK	Sub CPU failure
4	DD circuit operating faulty	→	Again supply power (press OPERATE button)	OK	Circuit operating error
		NG	Replace MAIN PWB ASS'Y	OK	Device drive circuit failure
5	Decoder operation faulty	→	Again supply power (press OPERATE button)	OK	Circuit operating error
		NG	Replace MAIN PWB ASS'Y	OK	Video process circuit failure
6	Video system data initializing error	→	Again supply power (press OPERATE button)	OK	Operating (loading) error
7	Internal temperature abnormally high	→	Avoid obstructing ventilation openings (intake and exhaust)	OK	Circuit error or other fault
		NG	Replace MAIN PWB ASS'Y	OK	Defective sensor and detection circuit
8	Out side temperature abnormally high	→	Ambient temperature of the unit should be mode into specification within the limits	OK	Circuit error or other fault
		NG	Replace MAIN PWB ASS'Y	OK	Defective sensor and detection circuit
9	Cooling fan stopped	→	Reinstall 713 connector	OK	Connector installation defective
		NG	Reinstall 705 connector	OK	Connector installation defective
		NG	Reinstall 706 connector	OK	Connector installation defective
		NG	Reinstall 707 connector	OK	Connector installation defective
		NG	Reinstall 714 connector	OK	Connector installation defective
		NG	Replace cooling fan	OK	Cooling fan defective
10	Confirmation of DVI activation	→	Temporarily disconnect power from projector and PC. After making sure that DVI cable has been properly connected, turn on power of projector and PC, in turn.	OK	Improper connection of DVI cable Wrong order of power on (Correct order : 1. Projector 2. PC)
		NG	Confirm that output of DVI terminal at graphic board of PC has been set properly.	OK	Improper setting of PC (DIV output)

5.3 ERROR LOG (SELF-DIAGNOSIS RECORD AND INDICATION)

5.3.1 Outline

By using the special setting and adjustment software, data related to abnormal operation (history) stored in the projector can be load. On the basis of contents "LED (INDICATOR) WARNING INDICATIONS" set and lamp use time, internal and external temperature, and other data prior to the previous usage time can be viewed as a table.

● HOW TO LOAD THE DATA FROM UNIT

- (1) Install the software in a personal computer and connect by RS-232C IN terminal (use cross cable).
- (2) Set the projector to stand-by mode.
- (3) Start the setting and adjustment software. The main menu shown in Fig.1 appears.
- (4) Click the [Error Log] button to show the screen indicated in Fig.2.
- (5) Click the [Receive Log Data] button to display the history.

● ERROR LOG SCREEN ITEMS

Item	Displayed contents
Error Detection	Error event code (10 types)
Wakeup Count	Number of times operation mode reached
System Time	Total time in operation mode until present
Lamp Time	Total lamp lighted time until present
Slave Deg (Out)	External temperature detected by sensor during error event
Sub Deg (In)	Internal temperature detected by sensor during error event

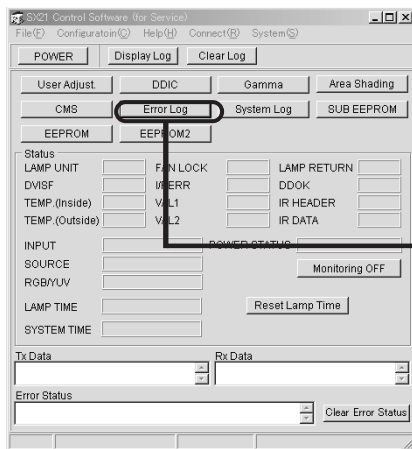

Fig.1 Start screen (main menu)

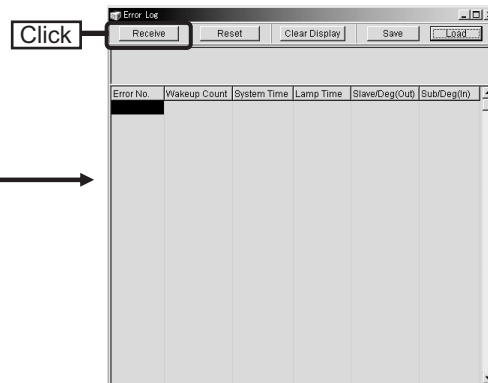

Fig.2 <Error log> screen

5.3.2 Error code

Error cord	Detected condition	Indicated LED
E01	Lamp can not light during shift from stand-by to operation mode	STAND BY + LAMP (Blinking)
E02	Lamp use time exceeds 2000h	LAMP (Blinking)
E03	Inter IC bus communication error (ACK receive error)	Absent
E06	Lamp extinguishes during projection	OPERATE + LAMP (Blinking)
E07	Cooling fan stops (fan lock)	All (4 LEDs Blinking)
E08	Set internal temperature (lamp area) abnormally high (Exceeds 70°C)	TEMP (Blinking)
E09	Set internal temperature (ventilation intake openings) abnormally high (Exceeds 62°C)	STAND BY + TEMP (Blinking)
E10	Lamp use time exceeds 1900h	LAMP(Light on)
E11	Error in device drive circuit operation	LAMP + TEMP (Blinking)
E15	Come off lamp cover	OPERATE + LAMP (Alternately blinking)
E20	When the sleep time function operated and the lamp goes out	Absent

5.3.3 Function

Button (item)	Function	Data process
Receive	Receive data stored in projector and display < Error log > screen	Projector to PC
Reset	Delete all data stored in projector (reset)	Projector internal
Clear Display	Delete record (history) shown on < Error log > screen (delete computer side)	PC internal
Save	Save record (history) shown on < Error log > screen to file	PC internal
Load	Read record (history) stored in PC and display in < Error log > screen	PC internal



JVC

VICTOR COMPANY OF JAPAN, LIMITED

ILA CENTER 12, 3-chome, Moriya-cho, kanagawa-ku, Yokohama, kanagawa-prefecture, 221-8528, Japan

(No.PA019)



Printed in Japan
VPT

Free Manuals Download Website

<http://myh66.com>

<http://usermanuals.us>

<http://www.somanuals.com>

<http://www.4manuals.cc>

<http://www.manual-lib.com>

<http://www.404manual.com>

<http://www.luxmanual.com>

<http://aubethermostatmanual.com>

Golf course search by state

<http://golfingnear.com>

Email search by domain

<http://emailbydomain.com>

Auto manuals search

<http://auto.somanuals.com>

TV manuals search

<http://tv.somanuals.com>