

# ACURITE®



Weather Stations



Temperature & Humidity



Weather Alert Radio



Kitchen Thermometers & Timers



Clocks

*It's More than Accurate, it's ACURITE®.*

AcuRite offers an extensive assortment of precision instruments, designed to provide you with information you can depend on to Plan your day with confidence™.

[www.AcuRite.com](http://www.AcuRite.com)

## Weather Center models 00608BPDI

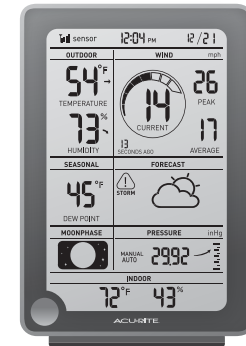

### CONTENTS

Unpacking Instructions.....2	Sensor & Display Placement...9
Package Contents.....2	3-in-1 Sensor Installation.....10
Product Registration.....2	Using the Weather Center.....11
Features & Benefits: 3-in-1.....3	Troubleshooting.....12
Features: Display Unit.....4	Care & Maintenance.....14
Setup.....6	Calibration.....15
3-in-1 Sensor Setup.....6	Specifications.....16
Display Unit Setup.....7	FCC Information.....16
Atomic Clock.....8	Customer Support.....17
Set Time, Date & Units.....8	Warranty.....17

**Questions?** Contact Customer Support at (877) 221-1252 or visit [www.AcuRite.com](http://www.AcuRite.com).

**SAVE THIS MANUAL FOR FUTURE REFERENCE.**

Congratulations on your new AcuRite product. To ensure the best possible product performance, please read this manual in its entirety and retain it for future reference.

## Unpacking Instructions

Remove the protective film that is applied to the LCD screen prior to using this product. Locate the tab and peel off to remove.

## Package Contents

1. Display unit with tabletop stand
2. 3-in-1 sensor
3. Sensor mounting bracket
4. Mounting hardware
5. Instruction Manual

## IMPORTANT

PRODUCT MUST BE REGISTERED TO RECEIVE WARRANTY SERVICE

### PRODUCT REGISTRATION

Register online to receive 1-year warranty protection

[www.AcuRite.com](http://www.AcuRite.com)

SHOP NOW

SUPPORT

Support Forum

Archived Products

▶ Register a Product

## Features & Benefits

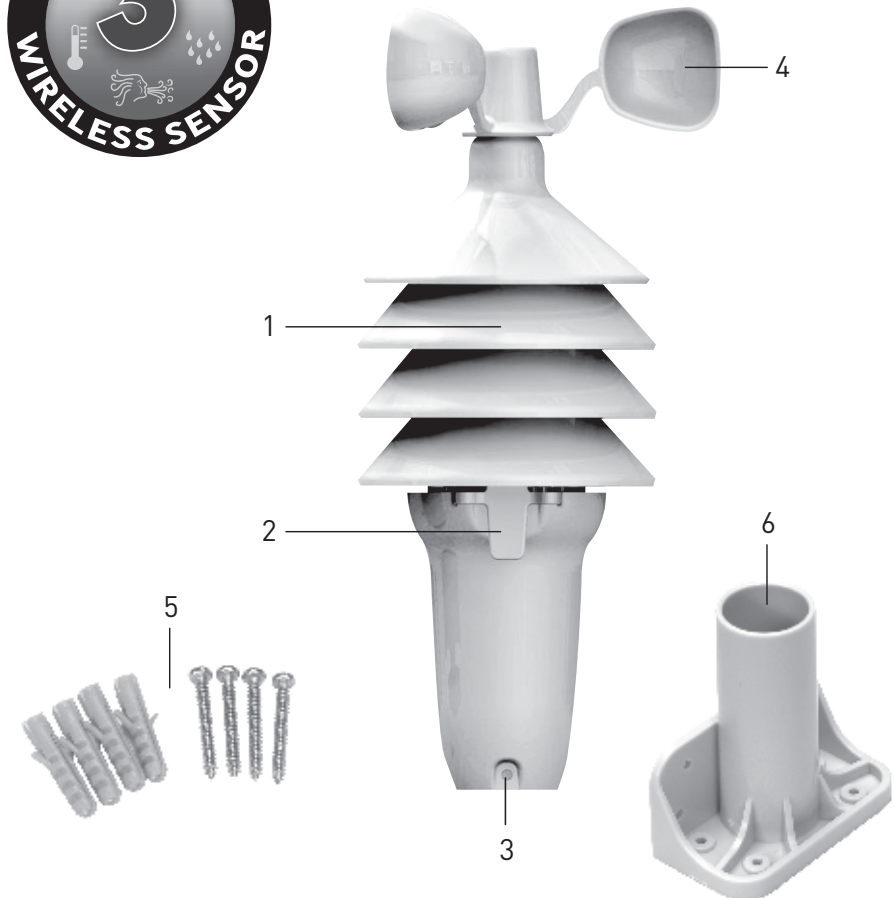

### 3-in-1 SENSOR

1. **Temperature & Humidity Sensors** (internal)
2. **Release Lever for Battery Access**
3. **Mounting Point**
4. **Wind Speed Anemometer**
5. **Mounting Hardware**  
Includes anchors and screws.

6. **Mounting Bracket**
7. **A-B-C Switch** (not shown)  
ID code that must match display's A-B-C switch to ensure units synchronize.

# Features & Benefits

## Display Unit

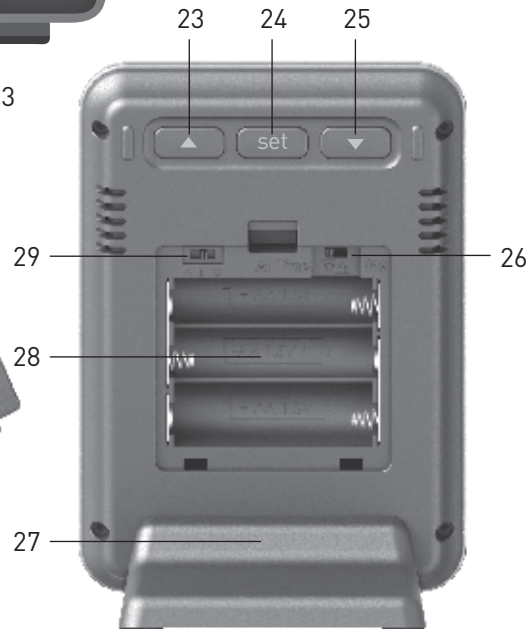
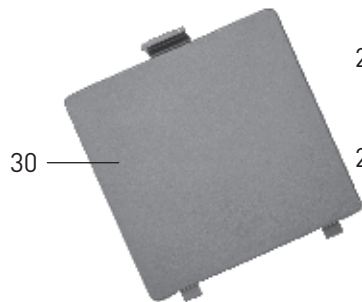
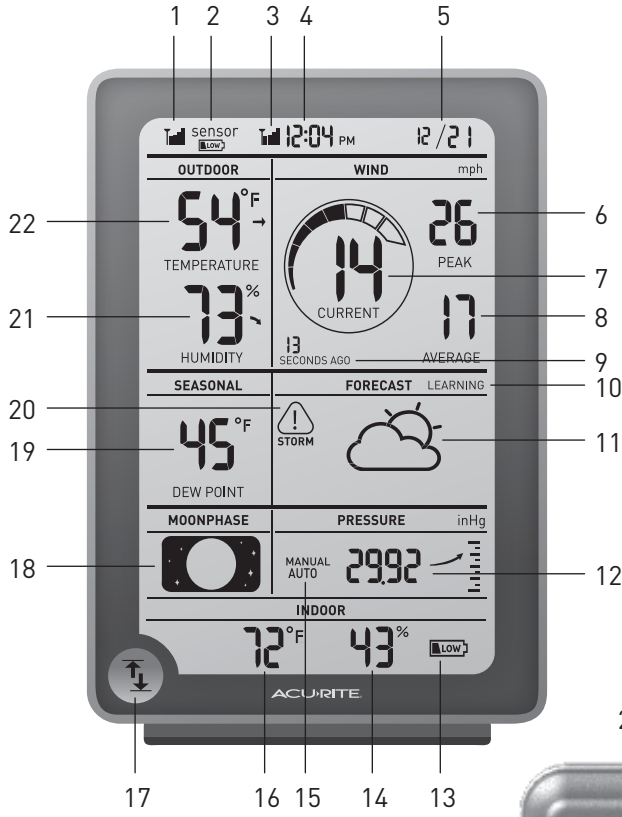

## DISPLAY UNIT

- 1. Wireless Sensor Signal Strength**
- 2. Low Sensor Battery Indicator**
- 3. Atomic Clock Signal Strength**
- 4. Atomic Clock**  
Maintains time with split-second accuracy and automatically updates for daylight saving time.
- 5. Date**
- 6. Peak Wind Speed**  
Highest speed from past 60 minutes.
- 7. Current Wind Speed**
- 8. Average Wind Speed**  
Based on all wind speed readings from the past 2 minutes.
- 9. Time Stamp for Last Wind Reading**  
Updates about every 18 seconds.
- 10. Learning Mode Icon**  
Disappears after weather forecast self-calibration is complete.
- 11. 12 to 24 Hour Weather Forecast**  
Self-Calibrating Forecasting pulls data from the outdoor sensor to generate your personal forecast.
- 12. Barometric Pressure**  
Arrow icon indicates the direction the pressure is trending.
- 13. Low Battery Indicator**
- 14. Current Indoor Humidity**
- 15. Auto or Manual Pressure Mode**  
Indicates pressure mode preference.  
**Auto Pressure Mode**  
Pressure will self-calibrate over a 14 day Learning Mode.  
**Manual Pressure Mode**  
Indicates the pressure has been manually calibrated.
- 16. Current Indoor Temperature**
- 17. Record Highs & Lows Button**  
View records for temperature and humidity.
- 18. Moon Phase**

- 19. Seasonal Select**  
Select between heat index, dew point, wind chill.
  - 20. Oncoming Storm Icon**  
Indicates a large, rapid pressure drop has been detected.
  - 21. Current Outdoor Humidity**  
Arrow icon indicates direction humidity is trending.
  - 22. Current Outdoor Temperature**  
Arrow icon indicates direction temperature is trending.
- ### Back of Display Unit
- 23. Adjust Up Arrow**  
for setup preferences.
  - 24. SET Button**  
for setup preferences.
  - 25. Adjust Down Arrow**  
for setup preferences.
  - 26. Daily / All-Time Records Button**  
Selects desired records to be viewed using Records Button (16).
  - 27. Removable Tabletop Stand**
  - 28. Battery Compartment**
  - 29. A-B-C Switch**  
ID code that must match sensor's A-B-C switch to ensure units synchronize.
  - 30. Battery Compartment Cover**

## 3-in-1 Sensor Setup

### 1 Install or Replace Batteries

Batteries **MUST** be installed for this product to operate. AcuRite recommends high quality alkaline or lithium batteries for the best product performance. Heavy duty or rechargeable batteries are not recommended.

The 3-in-1 sensor requires lithium batteries in low temperature conditions. Cold temperatures can cause alkaline batteries to function improperly. Use lithium batteries in the 3-in-1 sensor for temperatures below -4°F / -20°C.

1. Press the release lever and pull off the lower housing of the sensor.
2. Remove the battery compartment cover. Take note of the A-B-C switch setting inside the battery compartment for step 2.

3. Insert 4 x AA batteries into the battery compartment, as shown. Follow the polarity (+/-) diagram in the battery compartment.
4. Replace the battery cover and lower housing of the sensor.

### 2 Set the A-B-C Switch

The A-B-C switch is located inside the battery compartment. It can be set to A, B or C. However, you must select the same letter choices for both the sensor and the display unit in order for the units to synchronize.

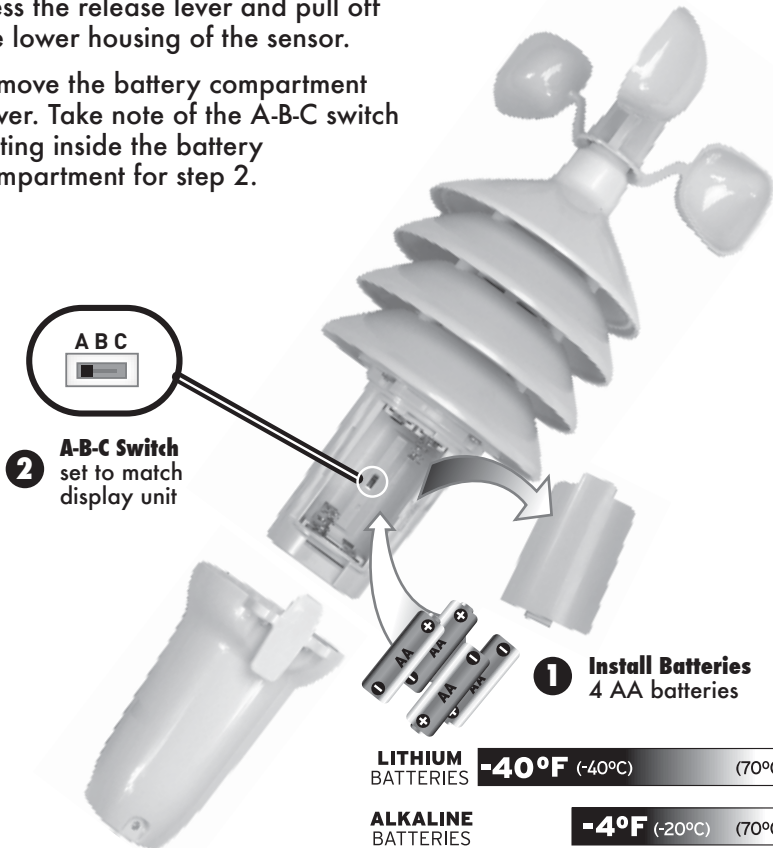

## Display Unit Setup

### 1 Install or Replace Batteries

1. Remove the battery compartment cover.
2. Insert 3 x AA alkaline batteries into the battery compartment, as shown. Follow the polarity (+/-) diagram in the battery compartment.
3. Replace the battery cover.

### 2 Set the A-B-C Switch

Locate the A-B-C switch inside the battery compartment. Set the A-B-C switch to A, B or C. You must select the same letter choices for both the display unit and the sensor in order for the units to synchronize.

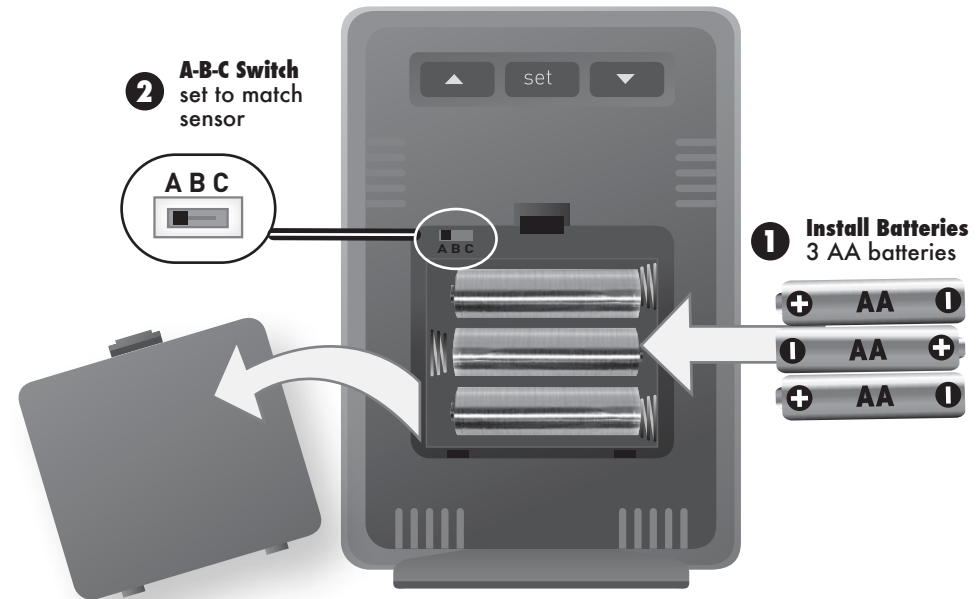

**PLEASE DISPOSE OF OLD OR DEFECTIVE BATTERIES IN AN ENVIRONMENTALLY SAFE WAY AND IN ACCORDANCE WITH YOUR LOCAL LAWS AND REGULATIONS.**

**BATTERY SAFETY:** Clean the battery contacts and also those of the device prior to battery installation. Remove batteries from equipment which is not to be used for an extended period of time. Follow the polarity (+/-) diagram in the battery compartment. Promptly remove dead batteries from the device. Dispose of used batteries properly. Only batteries of the same or equivalent type as recommended are to be used. DO NOT incinerate used batteries. DO NOT dispose of batteries in fire, as batteries may explode or leak. DO NOT mix old and new batteries or types of batteries (alkaline/standard). DO NOT use rechargeable batteries. DO NOT recharge non-rechargeable batteries. DO NOT short-circuit the supply terminals.

## Atomic Clock

AcuRite atomic clocks use a radio-controlled signal to synchronize to the correct time broadcast by the National Institute of Standards and Technology (NIST) Radio Station WWVB, located near Fort Collins, Colorado. WWVB broadcasts the current time and date with split-second accuracy.

This AcuRite atomic clock will maintain itself to the correct time, and automatically adjust itself for daylight saving time to provide the most accurate timekeeping standard possible.

Please note: The atomic signal generally takes a few hours to synchronize, so it is important to manually set the time and date after powering on the display.

## Set the Time, Date & Units

The clock and calendar are utilized to time stamp history records and other data, so it is important to set the time and date soon after you power on the display unit.

Press the "SET" button to enter SET MODE. Once in set mode, the preference you are currently setting will blink on the display.

To adjust the currently selected (flashing) item, press and release the "▲" or "▼" buttons (press and HOLD to fast adjust).

To save your adjustments, press and release the "SET" button again to adjust the next preference. The preference set order is as follows:

TIME ZONE (PST MST CST EST AST HAT [HAST] AKT [AKST])  
AUTO DST (Automatically adjust time -/+ on DST dates)  
CLOCK HOUR  
CLOCK MINUTE  
CALENDAR MONTH  
CALENDAR DATE  
CALENDAR YEAR  
UNITS: TEMPERATURE (°F or °C)  
UNITS: WIND SPEED (mph, kph, knots)  
UNITS: PRESSURE (inHg or mb)

You will automatically exit SET MODE if no buttons are touched for 30 seconds. Enter basic setup mode at any time by pressing the "SET" button.

## Placement for Maximum Accuracy

AcuRite sensors are sensitive to surrounding environmental conditions. Proper placement of both the display unit and the sensor are critical to the accuracy and performance of this product.



### Display Unit Placement

Place the display unit in a dry area free of dirt and dust. To ensure accurate temperature measurement, place out of direct sunlight and away from heat sources or vents. Display unit stands upright for tabletop use or is wall-mountable.



### 3-in-1 Sensor Placement

The 3-in-1 sensor is designed to remain outdoors all year long. Choose an open location with no obstructions above or around the sensor for the most accurate measurements.

## Important Placement Guidelines

Display unit and sensor must be within 330ft (100m) of each other.

### MAXIMIZE WIRELESS RANGE

Place units away from large metallic items, thick walls, metal surfaces, or other objects that may limit wireless communication.

### PREVENT WIRELESS INTERFERENCE

Place both units at least 3ft (.9m) away from electronic devices (TV, computer, microwave, radio, etc.).

### LOCATE AWAY FROM HEAT SOURCES

Position sensor away from heaters, air conditioners, chimneys, exhaust vents, asphalt and concrete (surfaces that radiate heat).

### LOCATE AWAY FROM HUMIDITY SOURCES

Avoid installing the sensor near pools, spas, or other bodies of water. Water sources may impact humidity accuracy.

### LOCATE AWAY FROM SPRINKLER HEADS

DO NOT install the sensor where it will be sprayed by a sprinkler system. This may force water inside the sensor.

### LOCATE AWAY FROM WIND & RAIN OBSTRUCTIONS

DO NOT mount the sensor with obstructions around it. Consider a location that is a wide open area, with few structures around to ensure accurate wind speed measurement.

Visit us online to view installation photos and video, or learn more about AcuRite technology:

[www.AcuRite.com/3in1](http://www.AcuRite.com/3in1)



View Video

### 3-in-1 Sensor Installation Guidelines

**INSTALLATION HEIGHT** Mount the sensor at least 5 feet (1.5 meters) off the ground (higher is better for wind measurement) in an open area. Secure to fence post, 2'x4' wood, 3/4" pole, etc. (not included)

**LEVEL INSTALLATION** Use a bubble level (not included) to ensure level installation for accurate wind measurement.

#### Top or Side Mount

1. Insert the mounting base into the hole on the bottom of the sensor.
2. Use one of the screws included in the hardware bag to fasten the lower sensor housing to the mounting base.
3. Make sure the sensor is level using a bubble level.
4. Fasten mounting base to a post or railing using 2 screws.

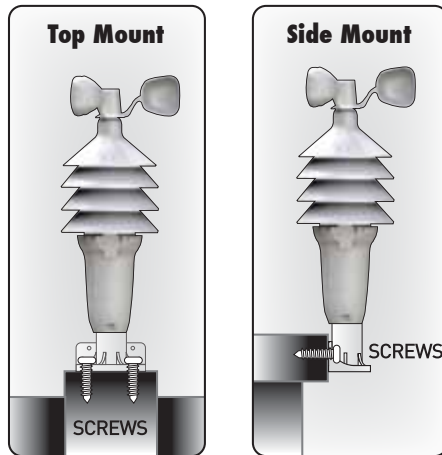

#### Pole Mount

1. Insert 3/4" schedule 40 PVC (25.8 mm O.D.) pole (not included) or similar item all the way into the hole on the bottom of the sensor. Note: Mounting base not used.
2. Use one of the screws included in the hardware bag to fasten the lower sensor housing securely to the pole.
3. Make sure the sensor is level using a bubble level.

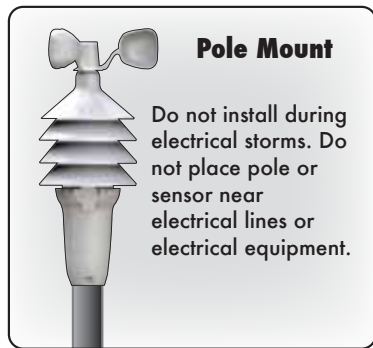

The 3-in-1 sensor is now ready to use.









### Basic Setup is Complete

The 3-in-1 sensor will now synchronize with the display unit. It may take a few minutes for synchronization to complete. If both or one of the units appear to be functioning improperly, please refer to the troubleshooting section.

### Using the Weather Center

#### Weather Forecast

AcuRite's patented Self-Calibrating Forecasting provides your personal forecast of weather conditions for the next 12 to 24 hours by collecting data from the sensor in your backyard. It generates a forecast with pinpoint accuracy - personalized for your exact location.

<b>EXAMPLE OF WEATHER FORECAST DISPLAY ICONS</b>	<b>RAIN LIKELY</b>  (flashing=stormy)	<b>LIGHT RAIN LIKELY</b> 	<b>PARTLY CLOUDY</b> 	<b>CLEARING</b> 
<b>RAIN/SNOW MIX LIKELY</b>  (flashing=stormy)	<b>SNOW LIKELY</b> 	<b>LIGHT SNOW LIKELY</b> 	<b>CLOUDY</b> 	<b>MOSTLY CLOUDY</b> 

View the complete list of icons at [www.AcuRite.com/acurite-icons](http://www.AcuRite.com/acurite-icons)

#### "Learning Mode"

Self-Calibrating Forecasting use a unique algorithm to analyze changes in pressure and temperature over a time period (called Learning Mode) to determine your altitude. After 14 days, the Learning Mode icon disappears from the display screen. At this point, the self-calibrated pressure is tuned in to your location and the unit is ready for superior weather prediction.

#### Barometric Pressure

Subtle variations in barometric pressure greatly affect the weather. This weather center displays the current pressure with an arrow icon to indicate the direction the pressure is trending (FALLING, STEADY, or RISING).

#### High & Low Records

The Record Highs & Lows button ( $\updownarrow$ ) displays minimum and maximum recordings for outdoor and indoor temperature and humidity. To select between viewing daily (since midnight) or all-time records, slide the switch located on the back of the display. To reset low records, press and hold the ( $\nabla$ ) button while viewing low records. To reset high records, press and hold the ( $\blacktriangle$ ) button while viewing high records.

#### Wind Speed

The Wind area of the display features WIND SPEED PEAK, AVERAGE, CURRENT WIND SPEED, and a graphic representation of current wind speed. There is also a time stamp for the last wind speed reading.

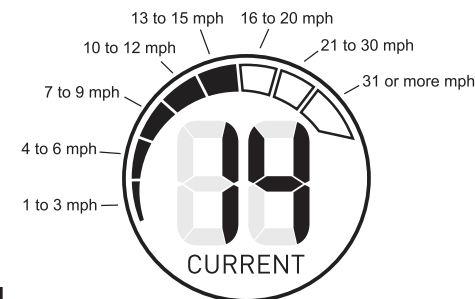

## Troubleshooting

Problem	Possible Solution
<p><b>No outdoor sensor reception</b></p> 	<ul style="list-style-type: none"> <li>Relocate the display unit and/or the 3-in-1 sensor. The units must be within 330ft (100m) of each other.</li> <li>Make sure both units are placed at least 3 feet (.9m) away from electronics that may interfere with the wireless communication (such as TVs, microwaves, computers, etc).</li> <li>Use standard alkaline batteries (or lithium batteries in sensor when temperature is below -4°F/-20°C). Do not use heavy duty or rechargeable batteries. NOTE: It may take up to 20 minutes for display unit and sensor to synchronize after batteries are replaced.</li> <li>Synchronize the units:               <ol style="list-style-type: none"> <li>Bring both the sensor and display unit indoors and remove at least one battery from each.</li> <li>Reinstall the battery in the outdoor sensor.</li> <li>Reinstall battery into the display unit.</li> <li>Let the units sit within a couple feet of each other for about 20 minutes to gain a strong connection.</li> </ol> </li> </ul>
<p><b>Outdoor temperature is flashing or showing dashes</b></p>	<p>Flashing of the outdoor temperature may be an indication of wireless interference.</p> <ul style="list-style-type: none"> <li>Make sure the A-B-C switch in the battery compartments of both the display unit and sensor are switched to the same letter. You may choose A, B or C; but both units must match to sync up.</li> </ul>
<p><b>Inaccurate forecast</b></p>	<ul style="list-style-type: none"> <li>Weather Forecast icon predicts conditions for the next 12 to 24 hours, not current conditions.</li> <li>Has Learning Mode icon disappeared from the display unit? Learning Mode must complete before forecast and pressure will be accurate.</li> <li>Allow unit to run continuously for 33 days. Battery removal or resetting the display unit will restart Learning Mode. After 14 days, forecast should be fairly accurate, however Learning Mode calibrates for a total of 33 days.</li> </ul>

## Troubleshooting

Problem	Possible Solution
<p><b>Inaccurate temperature or humidity</b></p>	<ul style="list-style-type: none"> <li>Make sure both the display unit and 3-in-1 sensor are placed out of direct sunlight and away from any heat sources or vents (see page 11).</li> <li>Make sure both units are positioned away from moisture sources (see page 11).</li> <li>Make sure 3-in-1 sensor is mounted at least 5ft off of the ground.</li> <li>Calibrate indoor and outdoor temperature and humidity (see page 20).</li> </ul>
<p><b>Inaccurate wind readings</b></p>	<ul style="list-style-type: none"> <li>What is wind reading being compared to? Pro weather stations are typically mounted at 30ft high or more. Make sure to compare data using a sensor positioned at the same mounting height.</li> <li>Check location of the sensor. Ensure it's mounted a minimum of 5ft in the air with no obstructions around it (within several feet).</li> <li>Ensure wind cups are spinning freely. If they hesitate or stop try lubricating with graphite powder or spray lubricant.</li> </ul>
<p><b>Display screen not working</b></p>	<ul style="list-style-type: none"> <li>Check that the batteries are installed correctly. Batteries may need to be replaced.</li> <li>Check that power adaptor is fully plugged in (if using power adapter for power source).</li> <li>Reset the display by pressing the reset button, located on the back of the display unit. Date and time will need to be entered after a reset.</li> </ul>

**If your AcuRite product does not operate properly after trying the troubleshooting steps, visit [www.AcuRite.com](http://www.AcuRite.com) or call (877) 221-1252 for assistance.**

## Care & Maintenance

### Display Unit Care

Clean with a soft, damp cloth. Do not use caustic cleaners or abrasives. Keep away from dust, dirt and moisture. Clean ventilation ports regularly with a gentle puff of air.

### 3-in-1 Sensor Care

#### Clean The Sensor

Clean with a soft damp cloth. Do not use caustic cleaners or abrasives.

#### Insect Prevention

Insects may cause obstructions and interrupt data by nesting in or on the 3-in-1 sensor. To limit this problem, spray sensor with a household insect repellent. Consult the insect repellent instructions prior to use.

#### Snow & Freezing Weather

The 3-in-1 sensor will not be damaged by freezing conditions.

#### Clean the Wind Anemometer

Remove foreign matter from the outside of the sensor for free movement of the wind anemometer. If needed, use a small amount of clear silicone spray lubricant or graphite powder on the anemometer for improved movement.

## Calibration

### Calibrate Temperature & Humidity

The indoor / outdoor temperature and humidity readings can be calibrated on the display unit to improve accuracy. Calibration can improve accuracy when 3-in-1 sensor placement or environmental factors impact your data accuracy.

1. Locate the "▲", "SET", and "▼" buttons on the back of the display unit. Press AND HOLD all three buttons for at least 5 seconds.
2. The temperature will begin flashing, indicating it is ready to be calibrated.
3. Press the up or down arrow buttons to calibrate the data value higher or lower from the actual reading.
4. Press the "SET" button to confirm the calibration adjustment. Note: The "∞" icon remains illuminated next to calibrated values.
5. The next calibratable data will begin flashing, indicating it is ready to be calibrated. Repeat Steps 1 - 4 to calibrate additional data.

### Calibrate Barometric Pressure

The Weather Center default pressure mode is "AUTO". In auto mode, the pressure will calibrate itself over a 14 day Learning Mode. Barometric pressure can be manually calibrated:

1. Locate the "▲", "SET", and "▼" buttons on the back of the display unit. Press AND HOLD all three buttons for at least 5 seconds.
2. Press the "SET" button to cycle through data until the pressure value begins flashing.
3. Press the "▲" or "▼" button to select "MANUAL" pressure mode.
4. Press the "SET" button to confirm.
5. Press the "▲" or "▼" buttons to calibrate the pressure value higher or lower from the self-calibrated reading.
6. Press the "SET" button to confirm the calibration adjustment. Note: The "∞" icon remains illuminated next to the calibrated value.



## Specifications

<b>TEMPERATURE RANGE</b>	Outdoor: -40°F to 158°F; -40°C to 70°C
	Indoor: 32°F to 122°F; 0°C to 50°C
<b>HUMIDITY RANGE</b>	Outdoor: 1% to 99%
	Indoor: 1% to 99%
<b>WIND SPEED</b>	0 to 99 mph; 0 to 159 kph
<b>WIRELESS RANGE</b>	330ft / 100m depending on home construction materials
<b>OPERATING FREQUENCY</b>	433mhz
<b>POWER</b>	7 x AA alkaline or lithium batteries (not included)
<b>DATA REPORTING</b>	Wind Speed: 18 seconds
	Outdoor temperature & humidity: 18 sec. updates
	Indoor temperature & humidity: 60 sec. updates

## FCC Information

This device complies with part 15 of FCC rules. Operation is subject to the following two conditions:

- 1- This device may NOT cause harmful interference, and
- 2- This device must accept any interference received, including interference that may cause undesired operation.

**WARNING:** Changes or modifications to this unit not expressly approved by the party responsible for compliance could void the user's authority to operate the equipment.

**NOTE:** This equipment has been tested and found to comply with the limits for a Class B digital device, pursuant to Part 15 of the FCC rules. These limits are designed to provide reasonable protection against harmful interference in a residential installation. This equipment generates, uses and can radiate radio frequency energy and, if not installed and used in accordance with the instructions, may cause harmful interference to radio communications. However, There is no guarantee that interference will not occur in a particular installation. If this equipment does cause harmful interference to radio or television reception, which can be determined by turning the equipment off and on, the user is encouraged to try to correct the interference by one or more of the following measures:

- Reorient or relocate the receiving antenna.
- Increase the separation between the equipment and the receiver.
- Connect the equipment into an outlet on a circuit different from that to which the receiver is connected.
- Consult the dealer or an experienced radio/TV technician for help.

**NOTE:** The manufacturer is not responsible for any radio or TV interference caused by unauthorized modifications to this equipment. Such modifications could void the user authority to operate the equipment.

This device complies with Industry Canada licence-exempt RSS standard(s).

Operation is subject to the following two conditions:

- (1) This device may not cause interference, and
- (2) This device must accept any interference received, including interference that may cause undesired operation of the device.

Le présent appareil est conforme aux CNR d'Industrie Canada applicables aux appareils radio exempts de licence.

L'exploitation est autorisée aux deux conditions suivantes:

- (1) l'appareil ne doit pas produire de brouillage, et
- (2) l'utilisateur de l'appareil doit accepter tout brouillage radioélectrique subi, même si le brouillage est susceptible d'en compromettre le fonctionnement.

## Customer Support

AcuRite customer support is committed to providing you with best-in-class service. **For assistance**, please have the model number of this product available and contact us in any of the following ways:



(877) 221-1252



info@chaney-inst.com

24/7 support at [www.AcuRite.com](http://www.AcuRite.com)

- › Installation Videos
- › Register your Product
- › Instruction Manuals
- › Support User Forum
- › Replacement Parts
- › Submit Feedback & Ideas

## IMPORTANT

PRODUCT MUST BE REGISTERED TO RECEIVE WARRANTY SERVICE

### PRODUCT REGISTRATION

Register online to receive 1-year warranty protection

[www.AcuRite.com](http://www.AcuRite.com)

### SUPPORT

Support Forum

Archived Products

▶ Register a Product

## Limited One Year Warranty

At AcuRite, we proudly uphold our commitment to quality technology. Chaney Instrument Co. warrants that all products it manufactures to be of good material and workmanship, and to be free of defects when properly installed and operated for a period of one year from the date of purchase.

We recommend that you visit us at [www.AcuRite.com](http://www.AcuRite.com) for the fastest way to register your product. However, product registration does not eliminate the need to retain your original proof of purchase in order to obtain warranty benefits.

Chaney Instrument Co. warrants that all products it manufactures to be of good material and workmanship, and to be free of defects when properly installed and operated for a period of one year from the date of purchase. Remedy for breach of this warranty is limited to repair or replacement of the defective item(s). Any product which, under normal use and service, is proven to breach the warranty contained herein within ONE YEAR from date of sale will, upon examination by Chaney, and at its sole option, be repaired or replaced by Chaney. Transportation costs and charges for returned goods shall be paid for by the purchaser. Chaney hereby disclaims all responsibility for such transportation costs and charges. This warranty will not be breached, and Chaney will give no credit for products it manufactures which have received

normal wear and tear, been damaged (including by acts of nature), tampered, abused, improperly installed, damaged in shipping, or repaired or altered by others than authorized representatives of Chaney.

The above-described warranty is expressly in lieu of all other warranties, express or implied, and all other warranties are hereby expressly disclaimed, including without limitation the implied warranty of merchantability and the implied warranty of fitness for a particular purpose. Chaney expressly disclaims all liability for special, consequential or incidental damages, whether arising in tort or by contract from any breach of this warranty. Some states do not allow the exclusion or limitation of incidental or consequential damages, so the above limitation or exclusion may not apply to you. Chaney further disclaims all liability from personal injury relating to its products to the extent permitted by law. By acceptance of any of Chaney's products, the purchaser assumes all liability for the consequences arising from their use or misuse. No person, firm or corporation is authorized to assume for Chaney any other liability in connection with the sale of its products. Furthermore, no person, firm or corporation is authorized to modify or waive the terms of this paragraph, and the preceding paragraph, unless done in writing and signed by a duly authorized agent of Chaney. This warranty gives you specific legal rights, and you may also have other rights which vary from state to state.

For in-warranty claims:

Chaney Instrument Co. | 965 Wells St. | Lake Geneva, WI 53147

## Free Manuals Download Website

<http://myh66.com>

<http://usermanuals.us>

<http://www.somanuals.com>

<http://www.4manuals.cc>

<http://www.manual-lib.com>

<http://www.404manual.com>

<http://www.luxmanual.com>

<http://aubethermostatmanual.com>

Golf course search by state

<http://golfingnear.com>

Email search by domain

<http://emailbydomain.com>

Auto manuals search

<http://auto.somanuals.com>

TV manuals search

<http://tv.somanuals.com>