

# **PC 8150**

**15" TFT Touch Panel Computer**

**User's Manual**



## **Disclaimers**

The information in this manual has been carefully checked and is believed to be accurate. ACNODES Co., Ltd. assumes no responsibility for any infringements of patents or other rights of third parties, which may result from its use.

ACNODES assumes no responsibility for any inaccuracies that may be contained in this document. ACNODES makes no commitment to update or to keep current the information contained in this manual.

ACNODES reserves the right to make improvements to this document and/or product at any time and without notice.

No part of this document may be reproduced, stored in a retrieval system, or transmitted, in any form or by any means, electronic, mechanical, photocopying, recording, or otherwise, without the prior written permission of ACNODES Co., Ltd.

**♥ Copyright 2007 by ACNODES Co., Ltd.**

**All rights reserved.**

**December 2007, Version A2**

## Safety Approvals

- 👁 CE Marking
- 👁 FCC Class A

### **FCC Compliance**

This equipment has been tested and complies with the limits for a Class A digital device, pursuant to Part 15 of the FCC Rules. These limits are designed to provide reasonable protection against harmful interference in a residential installation. If not installed and used in accordance with proper instructions, this equipment might generate or radiate radio frequency energy and cause harmful interference to radio communications. However, there is no guarantee that interference will not occur in a particular installation. If this equipment does cause harmful interference to radio or television reception, which can be determined by turning the equipment off and on, the user is encouraged to try to correct the interference by one or more of the following measures:

1. Reorient or relocate the receiving antenna.
2. Increase the separation between the equipment and receiver.
3. Connect the equipment into an outlet on a circuit different from that to which the receiver is connected.
4. Consult the dealer or an experienced radio/TV technician for help.

Shielded interface cables must be used in order to comply with emission limits.

## Safety Precautions

Before getting started, read the following important cautions.

1. The PC 8150 does not come equipped with an operating system. An operating system must be loaded first before installing any software into the computer.
2. Be sure to ground yourself to prevent static charge when installing the internal components. Use a grounding wrist strap and place all electronic components in any static-shielded devices. Most electronic components are sensitive to static electrical charge.
3. Disconnect the power cord from the PC 8150 before making any installation. Be sure both the system and the external devices are turned OFF. Sudden surge of power could ruin sensitive components. Make sure the PC 8150 is properly grounded.
4. The brightness of the flat panel display decreases with usage. However, hours of use vary depending on the application environment.
5. Turn OFF the system power before cleaning. Clean the system using a cloth only. Do not spray any liquid cleaner directly onto the screen. The PC 8150 may come with or w/o a touch screen. Although the touch screen is chemical resistant, it is recommended that you spray the liquid cleaner on a cloth first before wiping the screen. In case your system comes without the touch screen, you must follow the same procedure and not spray any cleaner on the flat panel directly.
6. Avoid using sharp objects to operate the touch screen. Scratches on the touch screen may cause malfunction or internal failure to the touch screen.
7. The flat panel display is not susceptible to shock or vibration. When assembling the PC 8150, make sure it is securely installed.

5. Do not open the system's back cover. If opening the cover for maintenance is a must, only a trained technician is allowed to do so. Integrated circuits on computer boards are sensitive to static electricity. To avoid damaging chips from electrostatic discharge, observe the following precautions:
  1. Before handling a board or integrated circuit, touch an unpainted portion of the system unit chassis for a few seconds. This will help to discharge any static electricity on your body.
  2. When handling boards and components, wear a wrist-grounding strap, available from most electronic component stores.

### **Trademarks Acknowledgments**

ACNODES is a trademark of ACNODES Co., Ltd.

IBM, PC/AT, PS/2, VGA are trademarks of International Business Machines Corporation.

Intel and Pentium are trademarks of Intel Corporation.

MS-DOS, Microsoft C and Quick BASIC are trademarks of Microsoft Corporation.

VIA is a trademark of VIA Technologies, Inc.

SST is a trademark of Silicon Storage Technology, Inc.

UMC is a trademark of United Microelectronics Corporation.

Other brand names and trademarks are the properties of their respective owners.

**This page does not contain any information.**

# Table of Contents

Disclaimers.....	ii
Safety Approvals.....	iii
FCC Compliance.....	iii
Safety Precautions .....	iv
<b>Chapter 1 .....</b>	<b>1</b>
<b>Introduction .....</b>	<b>1</b>
<b>1.1 General Description .....</b>	<b>1</b>
<b>1.2 Specifications .....</b>	<b>2</b>
1.2.1 Main CPU board.....	2
1.2.2 I/O System.....	2
1.2.3 System Specification .....	3
<b>1.3 Dimensions .....</b>	<b>4</b>
<b>1.4 Front View and I/O Outlets.....</b>	<b>5</b>
1.4.1 Front View.....	5
1.4.2 I/O Outlet.....	6
<b>1.5 Package list.....</b>	<b>7</b>
<b>Chapter 2 .....</b>	<b>8</b>
<b>Hardware Installation .....</b>	<b>8</b>
<b>2.1 CPU and DRAM Installation.....</b>	<b>9</b>
<b>2.2 HDD Installation.....</b>	<b>11</b>
<b>2.3 Serial Port Interface.....</b>	<b>14</b>
<b>2.4 VGA.....</b>	<b>14</b>
<b>2.5 Ethernet.....</b>	<b>14</b>
<b>2.6 Mountings: Panel / Wall / Rack / VESA / Desktop</b>	
<b>mount.....</b>	<b>15</b>
2.6.1 Panel Mount .....	15
2.6.2 Wall Mount.....	16
2.6.3 Rack Mount .....	17
2.6.4 VESA Mount .....	18
<b>Chapter 3 .....</b>	<b>19</b>



<b>Driver Installation .....</b>	<b>19</b>
<b>3.1 System.....</b>	<b>19</b>
<b>3.2 Touch Screen.....</b>	<b>20</b>
3.2.1 Specification .....	20
3.2.2 Driver Installation- Windows Vista/XP .....	21
3.2.3 Driver Installation- DOS .....	23
<b>Appendix A .....</b>	<b>28</b>
<b>EMBEDDED BOARD BIOS Setup.....</b>	<b>28</b>
<b>A.1 Entering Setup .....</b>	<b>28</b>
<b>A.2 Control Keys .....</b>	<b>29</b>
<b>A.3 Getting Help .....</b>	<b>29</b>
<b>A.4 The Main Menu.....</b>	<b>30</b>
<b>A.5 Standard CMOS Setup Menu .....</b>	<b>31</b>
<b>A.6 Advanced BIOS Features.....</b>	<b>34</b>
<b>A.7 Advanced Chipset Features .....</b>	<b>39</b>
<b>A.8 Integrated Peripherals.....</b>	<b>41</b>
<b>A.9 Power Management Setup .....</b>	<b>45</b>
<b>A.10 PnP/PCI Configuration Setup .....</b>	<b>48</b>
<b>A.11 PC Health Status.....</b>	<b>49</b>
<b>A.12 Frequency/Voltage Control.....</b>	<b>50</b>
<b>A.13 Load Optimized Defaults.....</b>	<b>50</b>
<b>A.14 Set Supervisor/User Password .....</b>	<b>51</b>
<b>A.15 Save &amp; Exit Setup .....</b>	<b>53</b>
<b>A.16 Exit Without Saving .....</b>	<b>54</b>
<b>Appendix B .....</b>	<b>55</b>
<b>Power Supply Specification .....</b>	<b>55</b>
<b>B.1 Power Supply: FSP180-50PLA1 (180W, AC     110~230V Input) .....</b>	<b>55</b>
3.1.1 ELECTRICAL REQUIREMENTS .....	55
3.1.2 EFFICIENCY .....	58
3.1.3 ENVIRONMENTAL REQUIREMENTS.....	58
3.1.4 MTBF .....	58
3.1.5 SAFETY .....	58



# Chapter 1

## Introduction

This chapter contains the general information and the detail specifications of the PC 8150. Chapter 1 includes the following sections:

- ④ **General Description**
- ④ **System Specification**
- ④ **Dimensions**
- ④ **Back View & I/O Outlets**
- ④ **Package List**

### 1.1 General Description

The PC 8150 is a TFT Touch Panel PC which equipped with Intel® Core 2 Duo processors and 15" XGA LCD display. The paradigmatic industrial panel computer, PC 8150, is a complete full-function and extreme cost-effective industrial HMI controller.

This ideal industrial-grade panel computer PC 8150 can be applied to the several of industrial or commercial projects, such as transportation, factory automation, HMI machine controller, Point Of Sales, KIOSK and more. Moreover, PC 8150 provides highly reliable and highly flexible industrial-grade products in all-in-one solutions.

## 1.2 Specifications

### 1.2.1 Main CPU board

- ④ **CPU:** Socket M (478-pin) for Intel® Core 2 Duo/ Core Duo/ Core Solo Processor with 533/667MHz.
- ④ **System Chipset:** Intel® 945GM+ICH\*7M.
- ④ **BIOS:** Phoenix-Award 4Mbit with RPL/PXE LAN boot ROM  
Smart View and Customer CMOS Backup
- ④ **System Memory:** 2 x 240-pin DDR2 DIMM  
Maximum up to 3GB
- ④ **Bus Clock:** 533/667MHz
- ④ **Watchdog Timer:** Up to 255 levels as Reset feature

### 1.2.2 I/O System

- ④ **Standard I/O:**
  - ⌘ 3 x serial ports with power;  
2 x RS-232, 1 x RS-232/422/485
  - ⌘ 1 x PS/2 for Keyboard Interface
  - ⌘ 1 x PS/2 for Mouse Interface
  - ⌘ 4 x USB Ports 2.0 compliant
  - ⌘ 2 x IEEE1394a ports
  - ⌘ 1 x 15 pin(female) for VGA output
- ④ **Ethernet:**
  - Dual RTL 8111B for PCI-E Gigabit Ethernet
- ④ **Audio:**
  - Realtek AC'97 codec audio
  - MIC-in, Line-out
- ④ **Storage:**
  - ⌘ 1 x PATA-100 IDE
  - ⌘ 2 x SATA-150
- ④ **Box-header:**
  - ⌘ 1 x 26-pin for shared FDD/LPT
  - ⌘ 1 x 10-pin for USB DOM

### 1.2.3 System Specification

- ④ **15" TFT LCD**
- ④ **Disk drive housing:**  
1 x 3.5" or 2 x 2.5" PATA/SATA drive
- ④ **AC power supply**
- ④ **Heat dispensing design**
- ④ **Net weight:**  
8.8 Kgs
- ④ **Dimension (main body size):**  
420x 335 x 86.4mm
- ④ **Operating temperature:**  
0° to 45°C ; Relative umidity:50%
- ④ **Relative humidity:**  
10% to 85% @ 40° C, non-condensing
- ④ **Altitude:**  
10,000 ft. (3,000 meters)
- ④ **Vibration (operating):**  
5 to 500 Hz, 1 G random
- ④ **Shock (operating):**  
10 G peak acceleration (11 msec. duration)



## 1.4 Front View and I/O Outlets

### 1.4.1 Front View

The figure below shows the features and controls on the PC 8150 front bezel.



SEL- SEL+ Backlight ON/OFF

### 1.4.2 I/O Outlet

The following figure shows the I/O locations of the PC 8150.

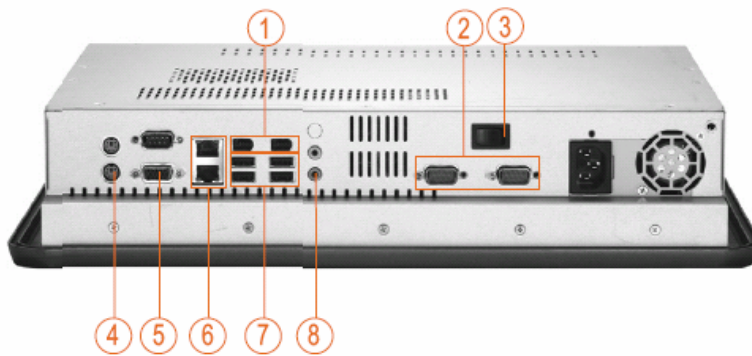

- |                     |                |
|---------------------|----------------|
| 1. 1394a            | 5. VGA         |
| 2. COM port         | 6. LAN         |
| 3. Power switch     | 7. USB 2.0 x 4 |
| 4. PS/2 x 2 (KB/MS) | 8. Audio       |





## **1.5 Package list**

When you receive the PC 8150 there are following items in the package. If you can not find it, please contact ACNODES distributors.

1. PC 8150 x 1
2. AC power cord x 1
3. Panel mount kit x 7
4. CD driver x1
5. Wall / VESA mount bracket kit x 1 (Optional)
6. Rack mount bracket kit x 1 (Optional)
7. Small HDD kit for 2.5" HDD (Optional)
8. Desktop kit (Optional)
9. VIA WLAN kit (Optional)



## **Chapter 2**

### **Hardware Installation**

The PC 8150 provides lots of flexible ways for user to select different configuration such as CPU, Hard Disk and more. The chapter will show you how to install the hardware. It includes:

- 👁 CPU
- 👁 DRAM
- 👁 Hard Disk
- 👁 Serial Port
- 👁 VGA
- 👁 Ethernet
- 👁 Mounting ways

## 2.1 CPU and DRAM Installation

The standard PC 8150 system is designed for Core 2 Duo level CPUs. The CPU board provides two 240-pin DDR2 DIMM socket that supports system memory up to 3GB.

When upgrading the CPU, DRAM, please refer to the following instructions and illustration:

1. Unscrew screws to remove the rear chassis.

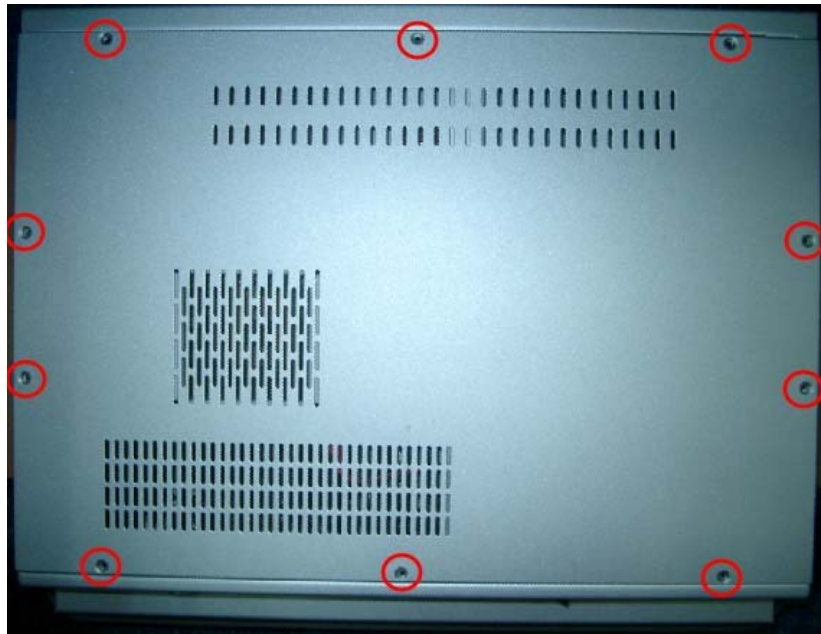

2. Install the CPU and DDR DRAM in the PC 8150.

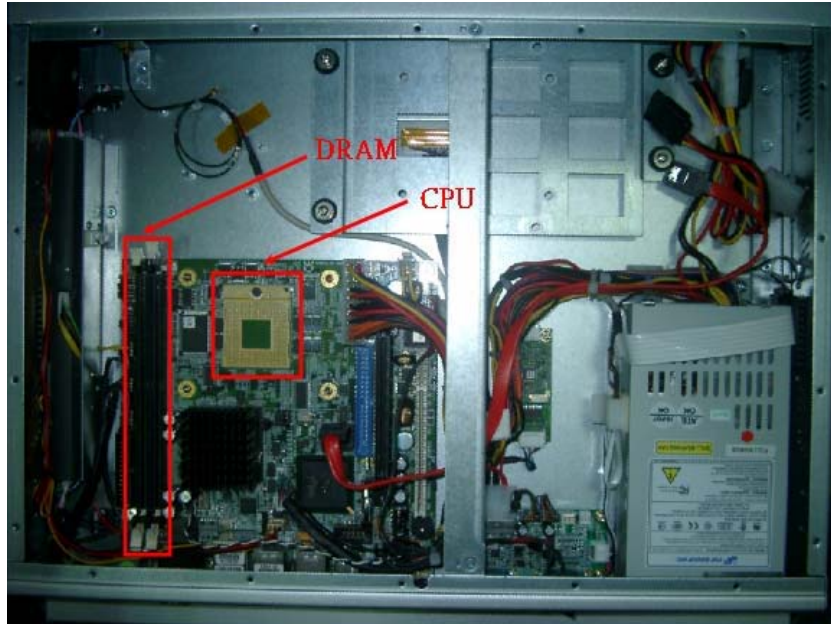

## 2.2 HDD Installation

The PC 8150 offers a convenient drive bay module for users to install HDD. The PC 8150 offers one 3.5" HDD drive for users to install. If you want to install one or two 2.5" HDD, the PC 8150 also provides the 3.5" to 2.5" drive holder to meet your requirement. Please follow the steps:

Note: There is the hardware limitation, so the 2.5" HDD and 3.5" HDD can't exist simultaneously.

1. Unscrew screws to remove the rear chassis.
2. Unscrew 4 screws from the HDD drive bracket, and take out HDD bracket kit to install 3.5" HDD.

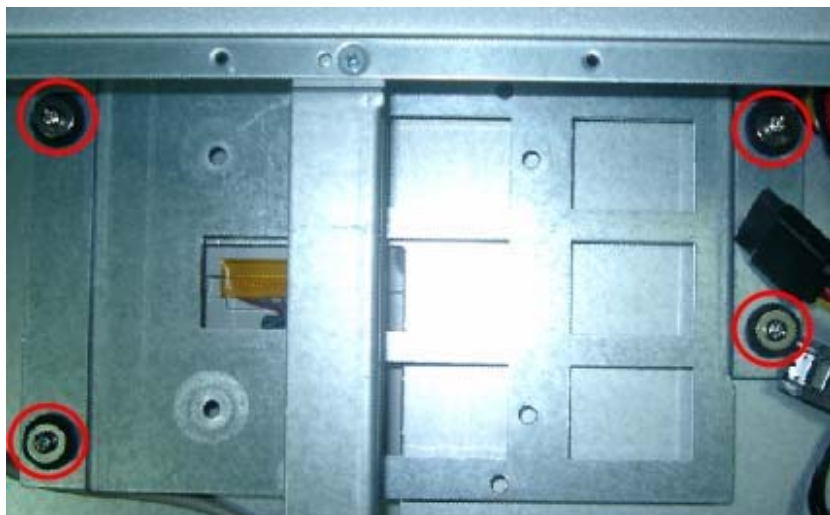

3. Installation complete.





In addition, installing the 2.5" HDD, please follow the steps:

1. Changing HDD rubber from 3.5" HDD bracket to 2.5" HDD bracket.

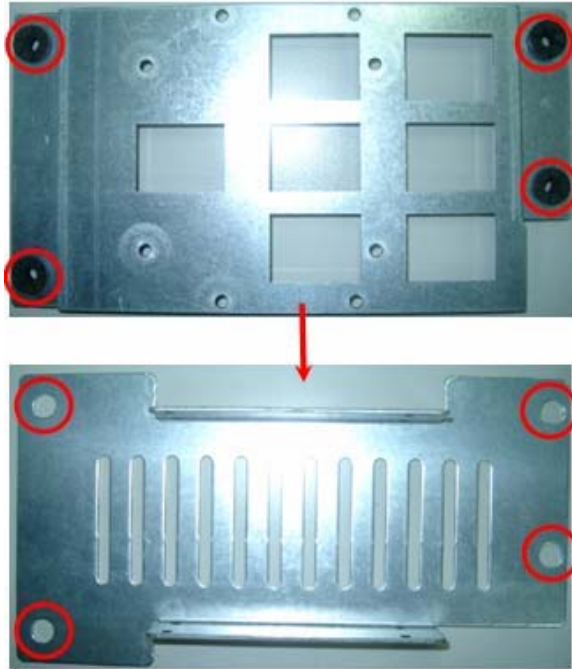

2. Installation complete.



## 2.3 Serial Port Interface

The PC 8150 has four onboard serial ports, COM1, COM2, COM3, COM4 are RS-232 Port Connector.

The connector, COM1, COM2, COM3 are DB-9 connector, and the following table shows the pin assignments of this connector.

Pin	Signal Name	Pin	Signal Name
1	DCD, Data carrier detect	6	DSR, Data set ready
2	RXD, Receive data	7	RTS, Request to send
3	TXD, Transmit data	8	CTS, Clear to send
4	DTR, Data terminal ready	9	RI/+5V/+12V Ring indicator
5	GND, ground		



## 2.4 VGA

The PC 8150 has an analog RGB interface connector. It is able to connect to an expansion CRT monitor, and the system can display on both the flat panel and the CRT simultaneously.

## 2.5 Ethernet

The PC 8150 provides 2 Ethernet (RJ-45) interfaces. For network connection, just plug in one cable end of the PC 8150 10/100/1000-Base-T Hub into the standard RJ-45 connector. The pin assignment of the RJ-45 is listed below.

COM1	Description
1	Tx+ (Data transmission positive)
2	Tx- (Data transmission negative)
3	Rx+ (Data reception positive)
4	RJ-1(For 100 base T-Only)
5	RJ-1(For 100 base T-Only)
6	Rx- (Data reception negative)
7	RJ-1(For 100 base T-Only)
8	RJ-1(For 100 base T-Only)
A	Active LED
B	100/1000 LAN LED

**CN9\_A**

## 2.6 Mountings: Panel / Wall / Rack / VESA / Desktop mount

There are four application options for the PC 8150, Panel / Wall / Rack & VESA mountings.

### 2.6.1 Panel Mount

The PC 8150 is designed for panel mount application. To mount the PC 8150, the standard set of mounting kit (included in the system packaging) is needed.

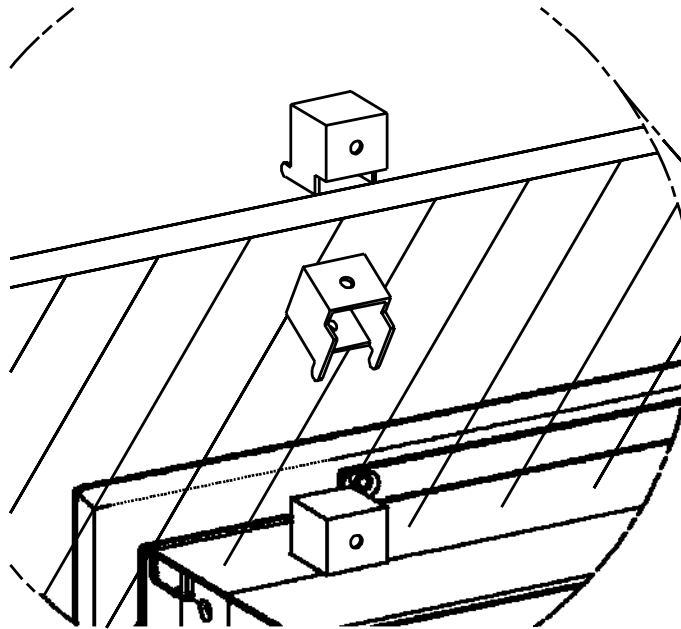

## 2.6.2 Wall Mount

The PC 8150 is designed for Wall mount application. The wall mount kit is optional. Please refer to the following figure.

1. Screw 6 screws to fix wall mount bracket.

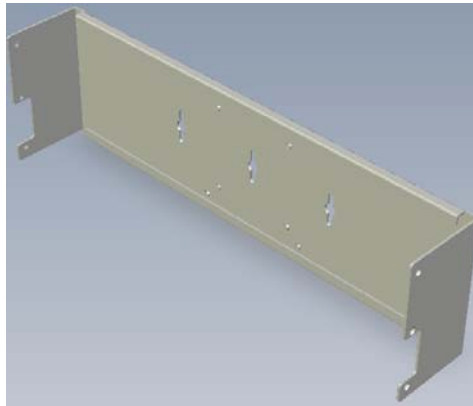

2. Complete.



### 2.6.3 Rack Mount

The PC 8150 also support rack mount. The rack mount kit is optional. Please refer to the following procedure.

1. Screw 5 screws each side.

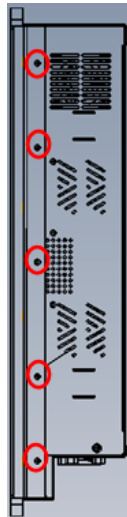

2. Complete.

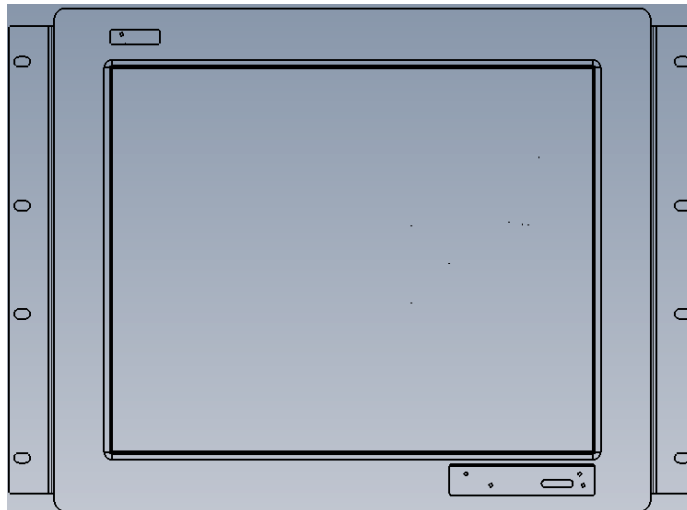

## 2.6.4 VESA Mount

The PC 8150 provides two ways for VESA mount: 75x75 mm and 100x100 mm. The VESA mount bracket is the same as wall mount bracket. Please refer to the following steps.

1. Assemble wall / VESA mount bracket.



2. Fix VESA arm.





## Chapter 3 Driver Installation

### 3.1 System

PC 8150 could support with Windows Vista/XP. To facilitate installation system driver, you should read the instructions in this chapter carefully before you attempt installation.

1. Panel series\PC 8150\Driver



Step 1. Chipset



Step 2. Graphic



Step 3. Gigabit Ethernet



Step 4. AC97 Audio



Step 5. Touch



Step 6. WiFi (Optional)

2. Select all files and follow the install procedure and press OK.



## 3.2 Touch Screen

### 3.2.1 Specification

Touch Screen:	5-wire Analog Resistive type
Touch Screen Controller:	DMC9000
Communications:	RS-232
Baud Rate:	19200 baud rate fixed
Resolution:	1024 x 1024 (10 bit A/D converter inside)
Power Input:	5V to 12V DC
Power Consumption:	12V: 27mA+ i where (i = v/touch screen sheet R) 5V: 23mA+ i where (i = v/touch screen sheet R)
Board Size:	6.0 x 2.0 cm
Portrait:	Support 90° to 270° screen rotation
Static Protection:	ESD device option
Others:	Touch activate indication LED on board

### 3.2.2 Driver Installation- Windows Vista/XP

The touch screen of PC 8150 provides a driver for use with Windows Vista/XP. To facilitate installation of the touch screen driver, you should read the instructions in this chapter carefully before you attempt installation.

1. Insert Driver CD and select the "Panel series\PC 8150\Driver \Step5 - Touch.



2. Follow the install procedure and press OK.
3. Click Start menu and select "PenMount Utilities". You can see PenMount Control Panel.

Notice: Please choose COM4 for touch screen installed.

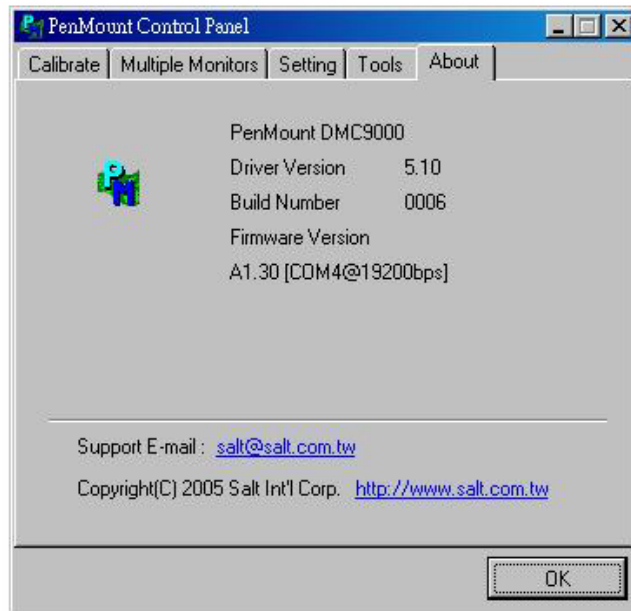

4. Select the "Standard Calibrate" tab



5. Calibration:

To adjust the display with touch panel, click "Calibration" and follow the calibrate point to do calibration; there are five points on screen for calibration.

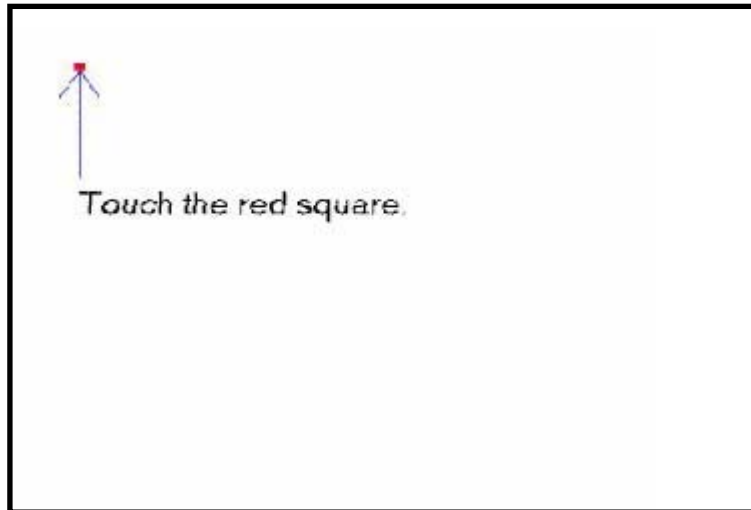

6. Press OK.

### 3.2.3 Driver Installation- DOS

**Using "INSTALL.EXE" utility to install PenMount software driver.**

1. Insert Driver CD and select the Panel series\PC 8150\Driver\Step5 - Touch\Driver\DOS\Setup.exe
2. Press ENTER key to install the drivers to drive C or use keyboard to key-in the hard disc drive that you plan to install the driver.
3. The driver will ask "Do you want to modify your Autoexec.bat to initialize Pen Mount ? (Y/N)" Suggest you choose "YES" for generating the initialization instructions in AUTOEXEC.BAT files. Then follow up the instructions to complete the installation.

### Identify the communication port and IRQ number

1. For the first time installation, or changing PenMount Touch Screen's COM port, use PMDETECT (e.g. C:\PENMOUNT\PMDETECT) to check the COM port and IRQ number. PMDETECT will save the correct data to PMOUSE.CFG file for further use.

The driver detects your communication COM port and IRQ number from COM1 IRQ4, COM2 IRQ3, COM3.... to COM4 IRQ15. PenMount driver can find the COM port and IRQ number automatically. The screen will then show:

**PenMount is initialized successfully!!!**

**Create file "pmouse.cfg". Success.**

**PenMount internal settings:**

**Comm. Port: COM<n> IRQ<n>**

.....

1. PMDETECT program is able to skip the IRQ number detecting if you Touchscreen Driver Installation **13** do not need to detect the specified IRQ number. For example, you do not need to detect IRQ5, and the command is:

C:\PENMOUNT\PMDETECT -N5

If you do not need to detect IRQ5 and IRQ9, the command is:

C:\PENMOUNT\PMDETECT -N5 -N9

### Do Calibration

1. To adjust the touch screen mapping properly to display screen, use PM.BAT (C:\PENMOUNT\PM) to do calibration. Choose "1" DO CALIBRATION (adjust screen mapping).
2. The message on screen asks you to select video mode number. Select

by keyboard to start the calibration, touch the upper-center point, then right-center point, bottom-center point and left-center point in sequence. After calibration, the data is shown in the screen, press any key to continue the progress.

3. After the calibration, suggest you to test touch screen and display

mapped results by choose "3" DRAWING TEST under PM.BAT

### Initializing the PenMount driver

If you don't have the initialization commands in AUTOEXEC.BAT, initialize PenMount C:\PENMOUNT\PMINIT) controller before you use the PenMount Touch Screen. The display will show the initialization message:

**PenMount V7.06 Copyright(c) SALT International Corp.**

**Test:COM<n> IRQ<n> (<n> is the number after PMDETECT done)**

**PenMount communication settings: COM<N> IRQ<n> Baud Rate:**

**<xxxx>**

... ..

### Demonstration

To demonstrate or test touch screen operation, selecting "3" DRAWING

TEST in PM.BAT file of Utility Directory. Drawing on screen. The other demonstration program called "ICECREAM.EXE" in the "PENMOUNT" directory can also be applied.

**This page does not contain any information.**







## Appendix A

### EMBEDDED BOARD BIOS Setup

Appendix A describes the different settings available in the Award BIOS that comes with the **EMBEDDED BOARD** CPU card. Also, the instructions on how to set up the BIOS configuration are contained in this chapter.

#### A.1 Entering Setup

There are two ways to enter the Setup program. You may either turn ON the computer and press <Del> immediately, or press the <Del> and/or <Ctrl>, <Alt>, and <Esc> keys simultaneously when the following message appears at the bottom of the screen during POST (Power on Self Test).

TO ENTER SETUP PRESS DEL KEY

If the message disappears before you respond and you still want to enter Setup, please restart the system to try it again. Turning the system power OFF and ON, pressing the "RESET" button on the system case or simultaneously pressing <Ctrl>, <Alt>, and <Del> keys can restart the system. If you do not press keys at the right time and the system doesn't boot, an error message will pop out to prompt you the following information:

PRESS <F1> TO CONTINUE, <CTRL-ALT-ESC> OR <DEL> TO ENTER SETUP

## A.2 Control Keys

<b>Up arrow</b>	Move cursor to the previous item
<b>Down arrow</b>	Move cursor to the next item
<b>Left arrow</b>	Move cursor to the item on the left hand
<b>Right arrow</b>	Move to the item in the right hand
<b>Esc key</b>	Main Menu -- Quit and delete changes into CMOS Status Page Setup Menu and Option Page Setup Menu -- Exit current page and return to Main Menu
<b>PgUp/“+” key</b>	Increase the numeric value or make changes
<b>PgDn/“-“ key</b>	Decrease the numeric value or make changes
<b>F1 key</b>	General help, only for Status Page Setup Menu and Option Page Setup Menu
<b>(Shift) F2 key</b>	Change color from total 16 colors. F2 to select color forward, (Shift) F2 to select color backward
<b>F3 key</b>	Reserved
<b>F4 key</b>	Reserved
<b>F5 key</b>	Restore the previous CMOS value from CMOS, only for Option Page Setup Menu
<b>F6 key</b>	Load the default CMOS value from BIOS default table, only for Option Page Setup Menu
<b>F7 key</b>	Load the Setup default, only for Option Page Setup Menu
<b>F8 key</b>	Reserved
<b>F9 key</b>	Reserved
<b>F10 key</b>	Save all the CMOS changes, only for Main Menu

## A.3 Getting Help

- ⌘ Main Menu  
The online description of the highlighted setup function is displayed at the bottom of the screen.
- ⌘ Status Page Setup Menu/Option Page Setup Menu  
Press <F1> to pop out a small Help window that provides the description of using appropriate keys and possible selections for highlighted items. Press <F1> or <Esc> to exit the Help Window.

## A.4 The Main Menu

Once you enter the Award BIOS CMOS Setup Utility, the Main Menu appears on the screen. In the Main Menu, there are several Setup functions and a couple of Exit options for your selection. Use arrow keys to select the Setup Page you intend to configure then press <Enter> to accept or enter its sub-menu.

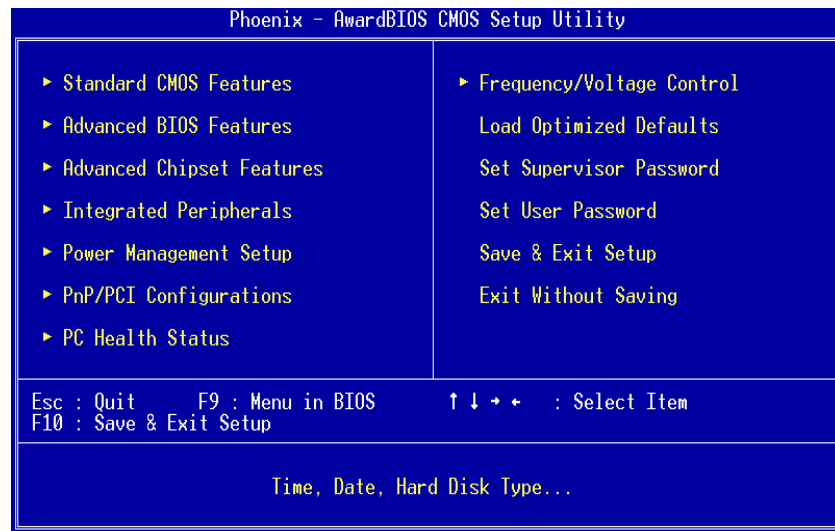

 **NOTE:** If your computer can not boot after making and saving system changes with Setup, the Award BIOS will reset your system to the CMOS default settings via its built-in override feature.

It is strongly recommended that you should avoid changing the chipset's defaults. Both Award and your system manufacturer have carefully set up these defaults that provide the best performance and reliability.

## A.5 Standard CMOS Setup Menu

The Standard CMOS Setup Menu displays basic information about your system. Use arrow keys to highlight each item, and use <PgUp> or <PgDn> key to select the value you want in each item.

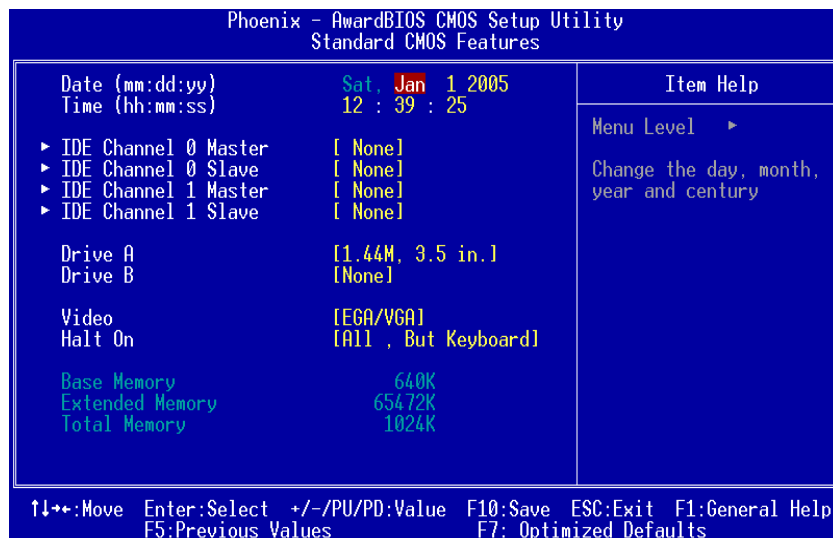

### ⌘ Date

The date format is <day>, <date> <month> <year>. Press <F3> to show the calendar.

<b>day</b>	It is determined by the BIOS and read only, from Sunday to Saturday.
<b>date</b>	It can be keyed with the numerical/ function key, from 1 to 31.
<b>month</b>	It is from January to December.
<b>year</b>	It shows the current year of BIOS.

### ⌘ Time

This item shows current time of your system with the format

<hour> <minute> <second>. The time is calculated based on the 24-hour military-time clock. For example, 1 p.m. is 13:00:00.

⌘ IDE Primary Master/Primary Slave

These items identify the types of each IDE channel installed in the computer. There are 45 predefined types (Type 1 to Type 45) and 2 user's definable types (Type User) for Enhanced IDE BIOS.

Press <PgUp>/<+> or <PgDn>/<-> to select a numbered hard disk type, or directly type the number and press <Enter>. Please be noted your drive's specifications must match the drive table. The hard disk will not work properly if you enter improper information. If your hard disk drive type does not match or is not listed, you can use Type User to manually define your own drive type.

If selecting Type User, you will be asked to enter related information in the following items. Directly key in the information and press <Enter>. This information should be provided in the documentation from your hard disk vendor or the system manufacturer.

If the HDD interface controller supports ESDI, select "Type 1".

If the HDD interface controller supports SCSI, select "None".

If the HDD interface controller supports CD-ROM, select "None".

<b>CYLS.</b>	number of cylinders	<b>LANDZONE</b>	landing zone
<b>HEADS</b>	number of heads	<b>SECTORS</b>	number of sectors
<b>PRECOMP</b>	write precom	<b>MODE</b>	HDD access mode

If there is no hard disk drive installed, select NONE and press <Enter>.

⌘ Drive A type/Drive B type

The category identifies the types of floppy disk drive A or drive B installed in the computer.

<b>None</b>	No floppy drive installed
<b>360K, 3.5 in</b>	3.5 inch PC-type standard drive; 360Kb Mini ITXcity
<b>1.2M, 3.5 in</b>	3.5 inch AT-type high-density drive; 1.2MB Mini ITXcity
<b>720K, 3.5 in</b>	3.5 inch double-sided drive; 720Kb Mini ITXcity
<b>1.44M, 3.5 in</b>	3.5 inch double-sided drive; 1.44MB Mini ITXcity
<b>2.88M, 3.5 in</b>	3.5 inch double-sided drive; 2.88MB Mini ITXcity

⌘ Halt On

This item determines whether the system will halt or not, if an error is detected while powering up.

**Halt On**

<b>No errors</b>	The system booting will halt on any errors detected. (default)
<b>All errors</b>	Whenever BIOS detects a non-fatal error, the system will stop and you will be prompted.
<b>All, But Keyboard</b>	The system booting will not stop for a keyboard error; it will stop for other errors.
<b>All, But Diskette</b>	The system booting will not stop for a disk error; it will stop for other errors.
<b>All, But Disk/Key</b>	The system booting will not stop for a keyboard or disk error; it will stop for other errors.

Press <Esc> to return to the Main Menu page.

## A.6 Advanced BIOS Features

This section allows you to configure and improve your system, to set up some system features according to your preference.

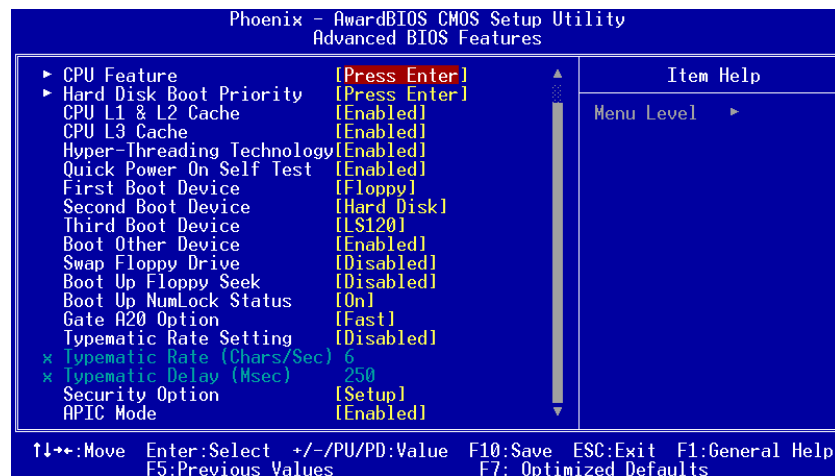

### ⌘ CPU Feature

Scroll to this item and press <Enter> to view the CPU Feature sub menu.

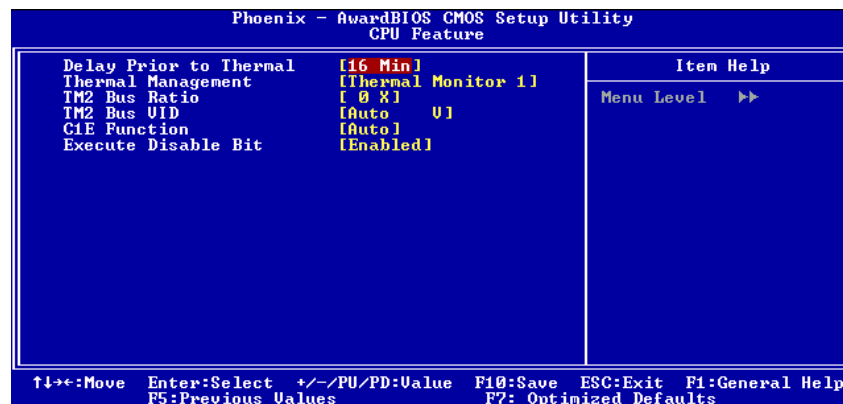



⌘ Hard Disk Boot Priority

Scroll to this item and press <Enter> to view the sub menu to decide the disk boot priority.

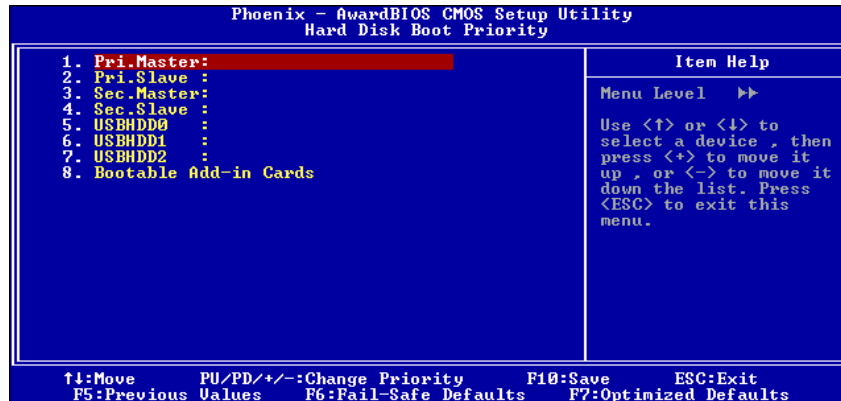

⌘ CPU L1 & L2 Cache

These two options speed up memory access. However, it depends on the CPU/chipset design. The default setting is "Enabled". CPUs with no built-in internal cache will not provide the "CPU Internal Cache" item on the menu.

Enabled	Enable cache
Disabled	Disable cache

⌘ Hyper-Threading Technology

Use this item to enable or disable Hyper-Threading Technology, which makes a single physical processor perform multi-tasking function as two logical ones.

⌘ Quick Power On Self Test

This option speeds up Power on Self Test (POST) after you turn on the system power. If set as Enabled, BIOS will shorten or skip some check items during POST. The default setting is "Enabled".

Enabled	Enable Quick POST
Disabled	Normal POST

⌘ First/Second/Third Boot Device

These items let you select the 1st, 2nd, and 3rd devices that the system will search for during its boot-up sequence. The wide range of selection includes Floppy, LS120, ZIP100, HDD0~3, SCSI, and CDROM.

⌘ Swap Floppy Drive

This allows you to determine whether to enable Swap Floppy Drive or not. When enabled, the BIOS swap floppy drive assignments so that Drive A becomes Drive B, and Drive B become Drive A. By default, this field is set to Disabled.

⌘ Boot Other Device

This item allows the user to enable/disable the boot device not listed on the First/Second/Third boot devices option above. The default setting is "Enabled".

⌘ Boot Up Floppy Seek

During POST, BIOS will determine the floppy disk drive type, 40 or 80 tracks. 360Kb type is 40 tracks while 720Kb, 1.2MB and 1.44MB are all 80 tracks. The default value is "Enabled".

<b>Enabled</b>	BIOS searches for floppy disk drive to determine if it is 40 or 80 tracks. Note that BIOS can not tell from 720K, 1.2M or 1.44M drive type as they are all 80 tracks.
<b>Disabled</b>	BIOS will not search for the type of floppy disk drive by track number. There will be no warning message displayed if the drive installed is 360K.

⌘ Boot Up NumLock Status

Set the the Num Lock status when the system is powered on.

The default value is "On".

⌘ Gate A20 Option

The default value is "Fast".

<b>Normal</b>	The A20 signal is controlled by keyboard controller or chipset hardware.
---------------	--

<b>Fast</b>	Default: Fast. The A20 signal is controlled by Port 92 or chipset specific method.
-------------	--

⌘ Typematic Rate Setting

This item determines the typematic rate of the keyboard. The default value is "Disabled".

⌘ Typematic Rate Setting

<b>Enabled</b>	Enable typematic rate and typematic delay programming.
<b>Disabled</b>	Disable typematic rate and typematic delay programming. The system BIOS will use default value of these 2 items, controlled by keyboard.

⌘ Typematic Rate (Chars/Sec)

This option refers to character numbers typed per second by the keyboard. The default value is "6".

<b>6</b>	6 characters per second
<b>8</b>	8 characters per second
<b>10</b>	10 characters per second
<b>12</b>	12 characters per second
<b>15</b>	15 characters per second
<b>20</b>	20 characters per second
<b>24</b>	24 characters per second
<b>30</b>	30 characters per second

⌘ Typematic Delay (Msec)

This option defines how many milliseconds must elapse before a held-down key begins generating repeat characters. The default value is "250".

<b>250</b>	250 msec
<b>500</b>	500 msec
<b>750</b>	750 msec
<b>1000</b>	1000 msec

⌘ Security Option

This item allows you to limit access to the system and Setup, or just to Setup. The default value is "Setup".

<b>System</b>	If a wrong password is entered at the prompt, the system will not boot, the access to Setup will be denied, either.
<b>Setup</b>	If a wrong password is entered at the prompt, the system will boot, but the access to Setup will be denied.



**NOTE:** To disable the security, select **PASSWORD SETTING** at Main Menu and then you will be asked to enter a password. Do not type anything, just press <Enter> and it will disable the security. Once the security is disabled, the system will boot and you can enter Setup freely.

#### ⌘ APIC Mode

Use this item to enable or disable APIC (Advanced Programmable Interrupt Controller) mode that provides symmetric multi-processing (SMP) for systems.

#### ⌘ MPS Version Control For OS

This item specifies the version of the Multiprocessor Specification (MPS). Version 1.4 has extended configuration tables to improve support for multiple PCI bus configurations and provide future expandability.

Press <Esc> to return to the Main Menu page.

## A.7 Advanced Chipset Features

This section contains completely optimized chipset's features on the board that you are strongly recommended to leave all items on this page at their default values unless you are very familiar with the technical specifications of your system hardware.

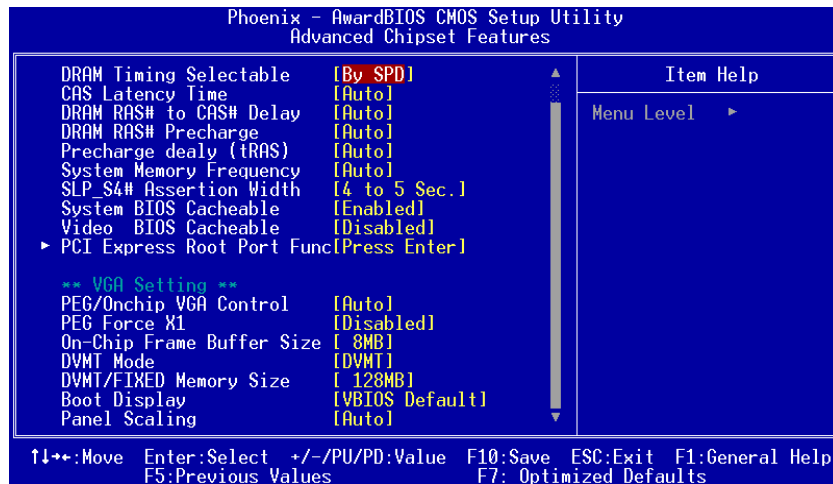

### ⌘ DRAM Timing Selectable

Use this item to increase the timing of the memory. This is related to the cooling of memory.

### ⌘ CAS Latency Time

You can select CAS latency time in HCLKs 2, 3, or Auto. The board designer should set the values in this field, depending on the DRAM installed. Do not change the values in this field unless you change specifications of the installed DRAM or the installed CPU.

### ⌘ System BIOS Cacheable

Selecting Enabled allows caching of the system BIOS ROM at F0000h-FFFFFh, resulting in better system performance. However, if any program writes to this memory area, a system error may result. The default value is "Disabled".

⌘ Video BIOS Cacheable

This item allows you to change the Video BIOS location from ROM to RAM. Video Shadow will increase the video speed.

⌘ PCI Express Root Port Func

Scroll to this item and press <Enter> to view the sub menu to decide the PCI Express Port.

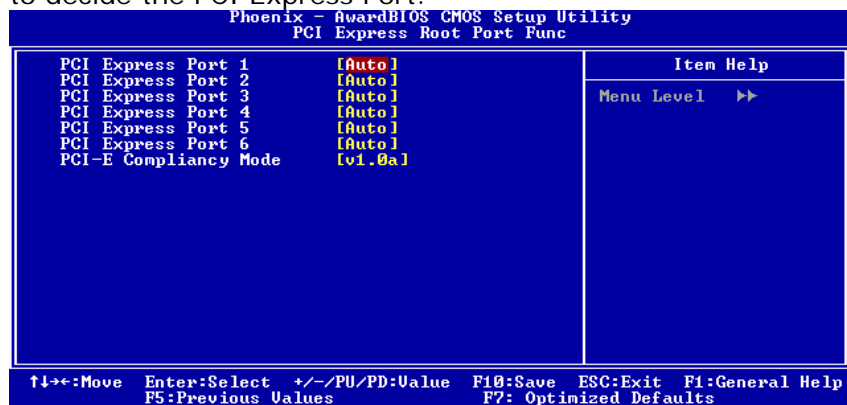

**Press <Esc> to return to the Advanced Chipset Features page, and press it again, return to the Main Menu page.**

## A.8 Integrated Peripherals

This section allows you to configure your SuperIO Device, IDE Function and Onboard Device.

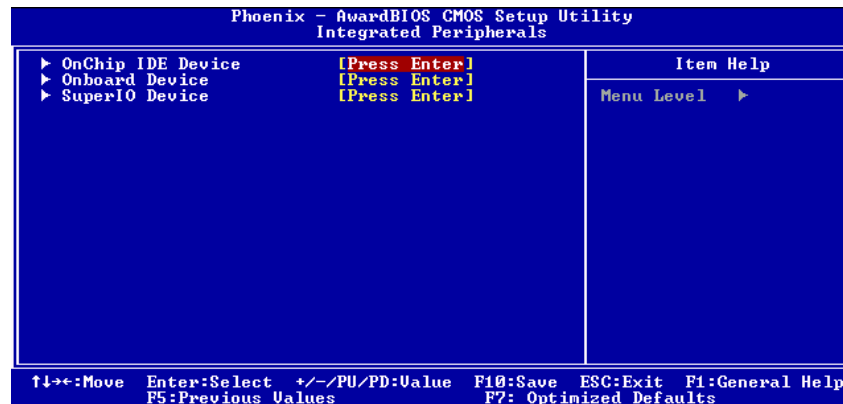

- ⌘ OnChip IDE Device  
Scroll to this item and press <Enter> to view the sub menu OnChip IDE Device.

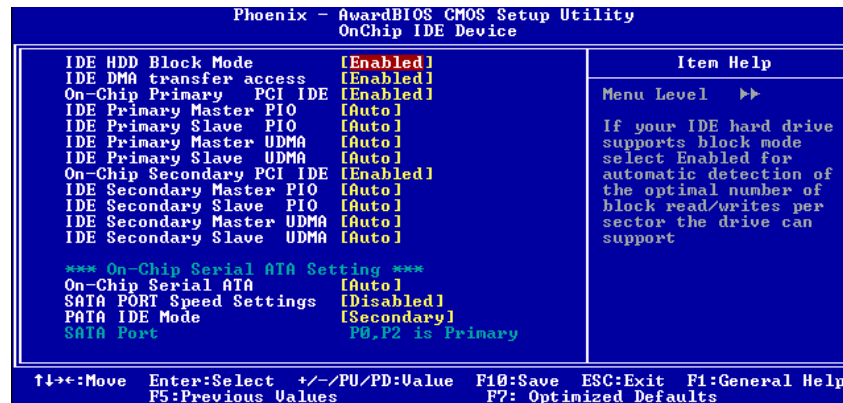

### ⌚ IDE HDD Block Mode

Block mode is also called block transfer, multiple commands, or multiple sector read/write. If your IDE hard drive supports block mode (most new drives do), select Enabled for automatic detection of the optimal number of block read/writes per sector the drive can support.

⌚ **IDE DMA transfer access**

Automatic data transfer between system memory and IDE device with minimum CPU intervention. This improves data throughput and frees CPU to perform other tasks.

⌚ **On-Chip Primary/Secondary PCI IDE**

The integrated peripheral controller contains an IDE interface with support for two IDE channels. Select Enabled to activate each channel separately. The default value is "Enabled".

**NOTE:** *Choosing Disabled for these options will automatically remove the IDE Primary Master/Slave PIO and/or IDE Secondary Master/Slave PIO items on the menu.*

⌚ **IDE Master/Slave PIO**

The four IDE PIO (Programmed Input/Output) fields let you set a PIO mode (0-4) for each of the four IDE devices that the onboard IDE interface supports. Modes 0 to 4 provide successively increased performance. In Auto mode, the system automatically determines the best mode for each device.

⌚ **IDE Master/Slave UDMA**

Select the mode of operation for the IDE drive. Ultra DMA-33/66/100/133 implementation is possible only if your IDE hard drive supports it and the operating environment includes a DMA driver. If your hard drive and your system software both support Ultra DMA-33/66/100/133, select Auto to enable UDMA mode by BIOS.

Press <Esc> to return to the Integrated Peripherals page, and press it again, return to the Main Menu page.

⌘ Onboard Device

**Scroll to this item and press <Enter> to view the sub menu Onboard Device.**



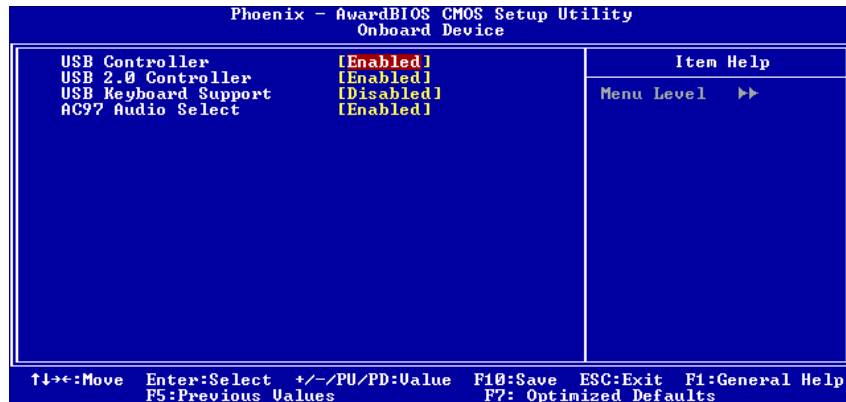

- ⌚ **USB Controller**  
 Enable this item if you are using the USB in the system. You should disable this item if a higher-level controller is added.
- ⌚ **USB 2.0 Controller**  
 Enable this item if you are using the EHCI (USB2.0) controller in the system.
- ⌚ **USB Keyboard Support**  
 Enable this item if the system has a Universal Serial Bus (USB) controller, and you have a USB keyboard.
- ⌚ **AC'97 Audio Select**  
 Use this item to enable or disable the onboard AC'97 Audio function.

Press <Esc> to return to the Integrated Peripherals page.

⌘ Super IO Device

Scroll to this item and press <Enter> to view the sub menu Super IO Device.

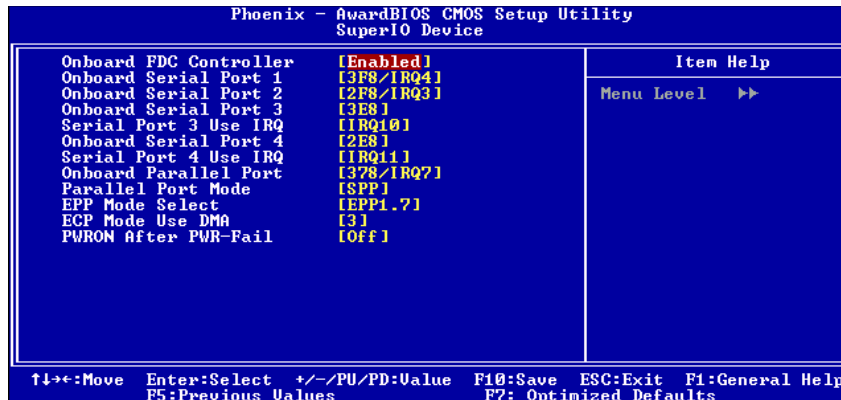

- ② **Onboard FDC Controller**  
Select Enabled if your system has a floppy disk controller (FDC) installed on the system board and you wish to use it. If you install and-in FDC or the system has no floppy drive, select Disabled in this field. The options available are Enabled, Disabled.
- ② **Onboard Serial Port 1 / 2 /3**  
Select an address and corresponding interrupt for the serial port. Options: 3F8/IRQ4, 2E8/IRQ3, 3E8/IRQ4, 2F8/IRQ3, Disabled, Auto.
- ② **Onboard Paralelel Port**  
This item allows you to determine access onboard parallel port controller with which I/O address. The options available are 378H/IRQ7, 278H/IRQ5, 3BC/IRQ7, Disabled.
- ② **Parallel Port Mode**  
Select an operating mode for the onboard parallel (printer) port. Select Normal unless your hardware and software require one of the other modes offered in this field. The options available are EPP1.9, ECP, SPP, ECPEPP1.7, EPP1.7.
- ② **EPP Mode Select**  
Select EPP port type 1.7 or 1.9.
- ② **ECP Mode Use DMA**  
Select a DMA channel for the parallel port for use during ECP mode.
- ② **PWRON After PWR-Fail**  
This item enables your computer to automatically restart or return to its operating status.

## A.9 Power Management Setup

The Power Management Setup allows you to save energy of your system effectively. It will shut down the hard disk and turn OFF video display after a period of inactivity.

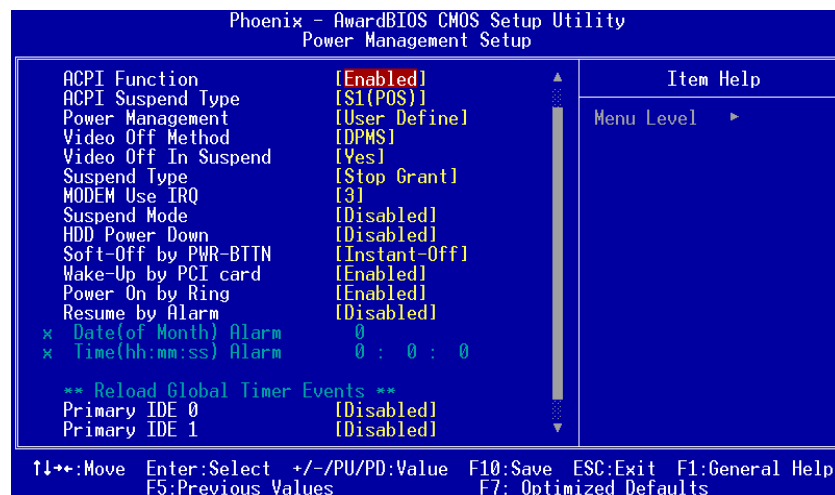

### ⌘ ACPI Function

This item allows you to enable/disable the Advanced Configuration and Power Management (ACPI). The function is always "Enabled".

### ⌘ ACPI Suspend Type

This item specifies the power saving modes for ACPI function. If your operating system supports ACPI, such as Windows 98SE, Windows ME and Windows 2000, you can choose to enter the Standby mode in S1 (POS) or S3 (STR) fashion through the setting of this field. Options are:

[S1(POS)] The S1 sleep mode is a low power state. In this state, no system context is lost (CPU or chipset) and

hardware maintains all system context.

[S3(STR)] The S3 sleep mode is a lower power state where the information of system configuration and open applications/files is saved to main memory that remains

powered while most other hardware components turn off to save energy. The information stored in memory will be used to restore the system when a "wake up" event occurs.

⌘ Power Management

This option allows you to select the type of power Management. The options available are APM, ACPI.

⌘ Video Off Method

This setting determines the manner in which the monitor is blanked.

<b>V/H SYNC+Blank</b>	Turns OFF vertical and horizontal synchronization ports and writes blanks to the video buffer
<b>DPMS</b>	Select this option if your monitor supports the Display Power Management Signaling (DPMS) standard of the Video Electronics Standards Association (VESA). Use the software supplied for your video subsystem to select video power management values.
<b>Blank Screen</b>	System only writes blanks to the video buffer.

⌘ Suspend Mode

After the selected period of system inactivity (1 minute to 1 hour), all devices except the CPU shut off. The default value is "Disabled".

<b>Disabled</b>	System will never enter SUSPEND mode
<b>1/2/4/6/8/10/20/30/40 Min/1 Hr</b>	Defines the continuous idle time before the system entering SUSPEND mode. If any item defined in (J) is enabled & active, SUSPEND timer will be reloaded

⌘ HDD Power Down

If HDD activity is not detected for the length of time specified in this field, the hard disk drive will be powered down while

all other devices remain active.

⌘ Soft-Off by PWR-BTTN

This option only works with systems using an ATX power supply. It also allows the user to define which type of soft power OFF sequence the system will follow. The default value is "Instant-Off".

<b>Instant-Off</b>	This option follows the conventional manner systems perform when power is turned OFF. Instant-Off is a soft power OFF sequence requiring only the switching of the power supply button to OFF
<b>Delay 4 Sec.</b>	Upon turning OFF system from the power switch, this option will delay the complete system power OFF sequence by approximately 4 seconds. Within this delay period, system will temporarily enter into Suspend Mode enabling you to restart the system at once.

⌘ Wake-Up by PCI card

If enable this item, the system can automatically resume when the PCI Modem or PCI LAN card receives an incoming call.

⌘ Power On by Ring

This option allows the system to resume or wake up upon detecting any ring signals coming from an installed modem. The default value is "Enabled".

⌘ Resume by Alarm

If enable this item, the system can automatically resume after a fixed time in accordance with the system's RTC (realtime clock).

Press <Esc> to return to the Main Menu page.

## A.10 PnP/PCI Configuration Setup

This section describes the configuration of PCI (Personal Computer Interconnect) bus system, which allows I/O devices to operate at speeds close to the CPU speed while communicating with other important components. This section covers very technical items that only experienced users could change default settings.

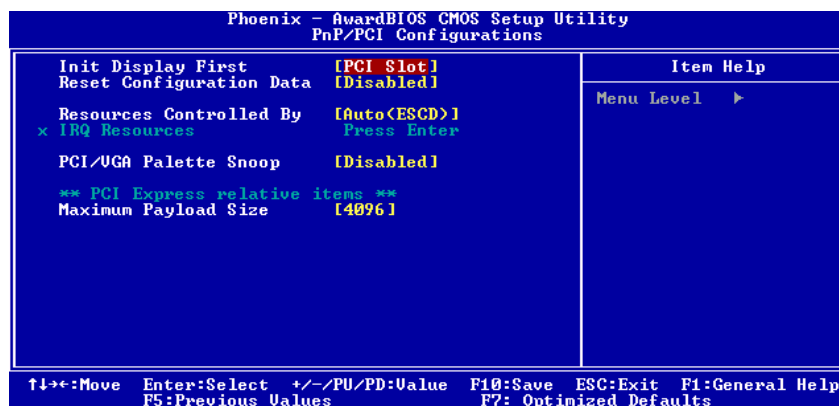

### ⌘ Init Display First

This item allows you to decide to active whether PCI Slot or AGP first. The options available are PCI Slot, AGP.

### ⌘ Reset Configuration Data

Normally, you leave this item Disabled. Select Enabled to reset Extended System Configuration Data (ESCD) when you exit Setup or if installing a new add-on cause the system reconfiguration a serious conflict that the operating system can not boot. Options: Enabled, Disabled.

### ⌘ Resources Controlled By

The Award Plug and Play BIOS can automatically configure all boot and Plug and Play-compatible devices. If you select Auto, all interrupt request (IRQ), DMA assignment, and Used DMA fields disappear, as the BIOS automatically assigns them. The default value is "Manual".

### ⌘ IRQ Resources

When resources are controlled manually, assign each system

interrupt to one of the following types in accordance with the type of devices using the interrupt:

1. Legacy ISA Devices compliant with the original PC AT bus specification, requiring a specific interrupt (such as IRQ4 for serial port 1).
2. PCI/ISA PnP Devices compliant with the Plug and Play standard, whether designed for PCI or ISA bus architecture.

The default value is "PCI/ISA PnP".

### ⌘ PCI/VGA Palette Snoop

Some non-standard VGA display cards may not show colors properly. This item allows you to set whether MPEG ISA/VESA VGA Cards can work with PCI/VGA or not. When enabled, a PCI/VGA can work with a MPEG ISA/VESA VGA card; when disabled, a PCI/VGA cannot work with a MPEG ISA/VESA Card.

## A.11 PC Health Status

This section supports hardware monitoring that lets you monitor those parameters for critical voltages, temperatures and fan speed of the board.

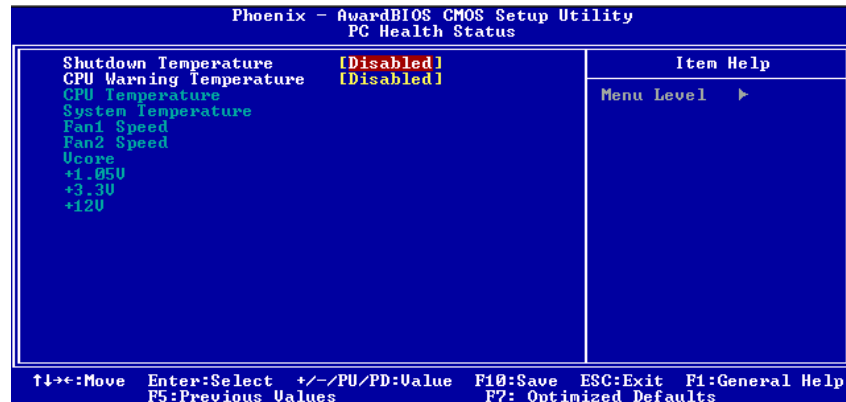

### ⌘ Current CPU Temperature

These read-only fields reflect the functions of the hardware thermal sensor that monitors the chip blocks and system temperatures to ensure the system is stable.

## A.12 Frequency/Voltage Control

This section is to control the CPU frequency and Supply Voltage, DIMM OverVoltage and AGP voltage.

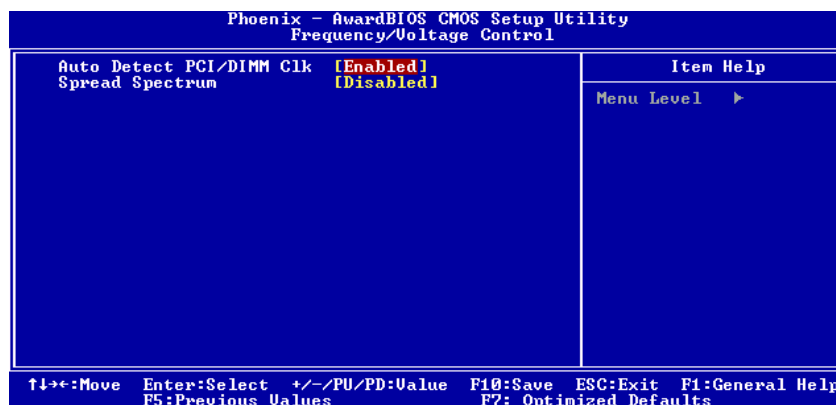

### ⌘ Auto Detect PCI Clk

The enabled item can automatically disable the clock source for a PCI slot without a module, to reduce EMI (ElectroMagnetic Interference).

### ⌘ Spread Spectrum

If spread spectrum is enabled, EMI (ElectroMagnetic Interference) generated by the system can be significantly reduced.

## A.13 Load Optimized Defaults

This option allows you to load your system configuration with default values. These default settings are optimized to enable high performance features.



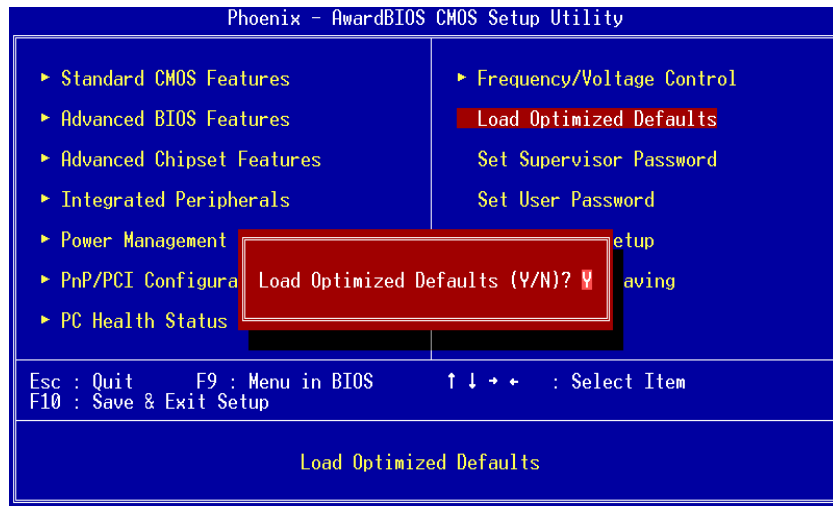

To load CMOS SRAM with SETUP default values, please enter “Y”. If not, please enter “N”.

## A.14 Set Supervisor/User Password

You can set a supervisor or user password, or both of them. The differences between them are:

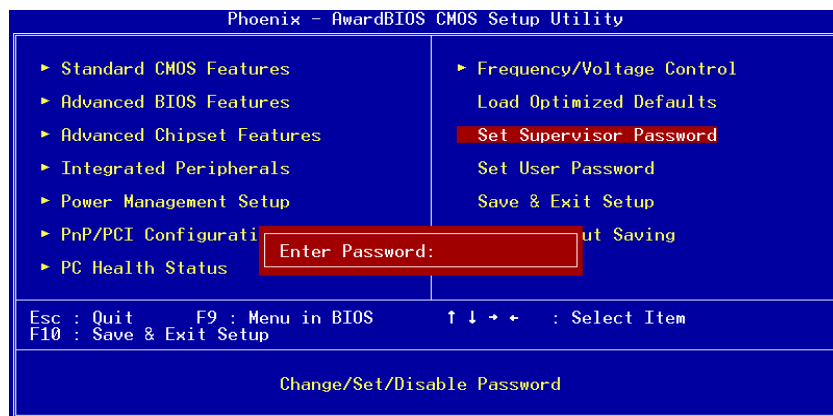

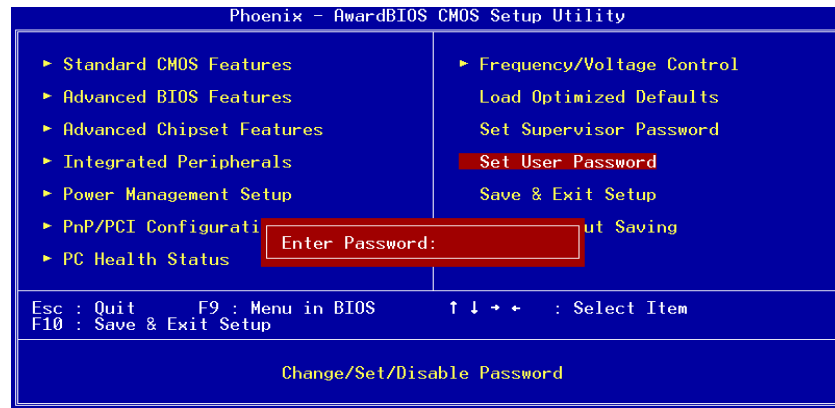

1. **Supervisor password:** You can enter and change the options on the setup menu.
2. **User password:** You can just enter, but have no right to change the options on the setup menu.

When you select this function, the following message will appear at the center of the screen to assist you in creating a password.

#### ENTER PASSWORD

Type a maximum eight-character password, and press <Enter>. This typed password will clear previously entered password from the CMOS memory. You will be asked to confirm this password. Type this password again and press <Enter>. You may also press <Esc> to abort this selection and not enter a password.

To disable the password, just press <Enter> when you are prompted to enter a password. A message will confirm the password is getting disabled. Once the password is disabled, the system will boot and you can enter Setup freely.

### PASSWORD DISABLED

When a password is enabled, you have to type it every time you enter the Setup. It prevents any unauthorized persons from changing your system configuration.

## A.15 Save & Exit Setup

This section allows you to determine whether or not to accept your modifications. Type "Y" to quit the setup utility and save all changes into the CMOS memory. Type "N" to bring you back to the Setup utility.

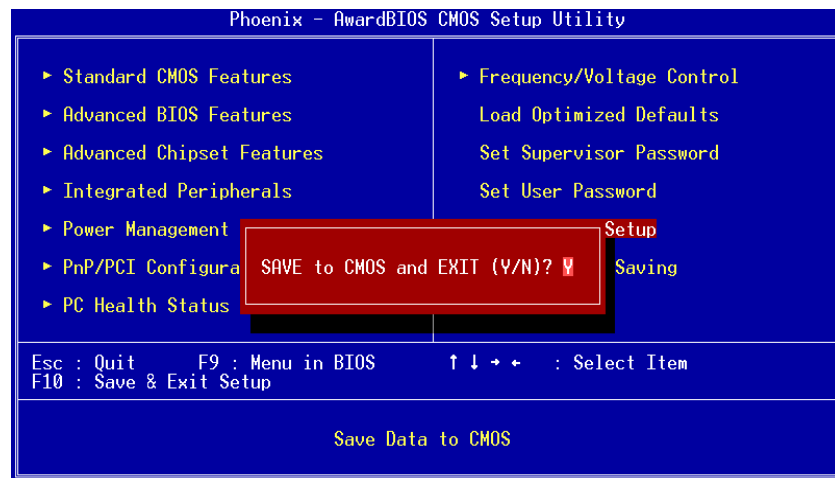

## A.16 Exit Without Saving

Select this option to exit the Setup utility without saving changes you have made in this session. Type "Y", and it will quit the Setup utility without saving your modifications. Type "N" to return to the Setup utility.

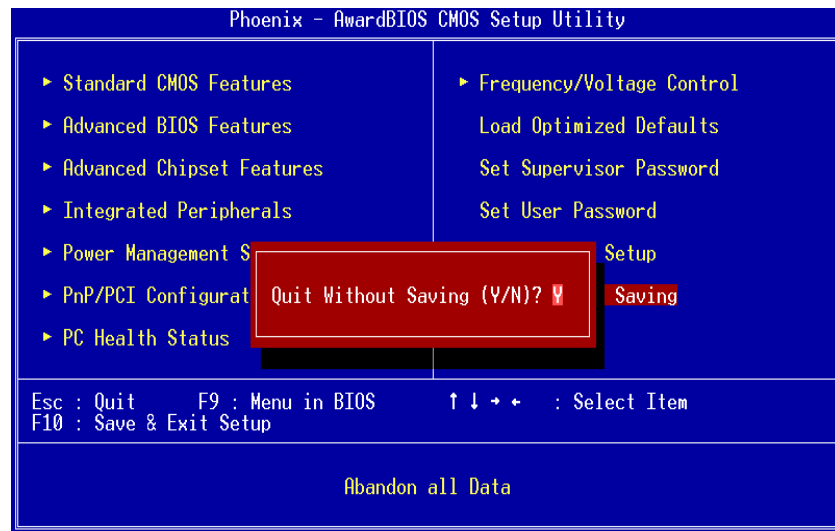

## Appendix B

### Power Supply Specification

#### B.1 Power Supply: FSP180-50PLA1 (180W, AC 110~230V Input)

##### B.1.1 ELECTRICAL REQUIREMENTS

###### OUTPUT ELECTRICAL REQUIREMENTS

The subject power supply will meet all electrical specifications below, over the full operation temperature range and dynamic load regulation.

###### OUTPUT RATING

Output	Nominal	Regulation	Ripple/Noise	Min	Max
1	+3.3V	±5%	50mV	0.3A	16.8A
2	+5V	±5%	50mV	0.3A	12.0 A
3	+12V	±5%	120mV	1.5A	10.0 A
4	-12V	±10%	120mV	0.0 A	0.8A
5	+5VSB	±5%	50mV	0.0 A	2.0A

※ -12V,+3.3V, +5V,+12V will have the regulation to ±10% when all load take off.

The +3.3V and +5V total output shall not exceed 61 watts. The +3.3V, +5V, and +12V total output shall not exceed 160 watts and the total output for this subject power supply is 180 watts.

## LOAD CAPACITY SPECIFICATIONS

The cross regulation defined as follows, the voltage regulation limits DC include DC Output ripple & noise.

LOAD	STM	+3.3V	+5V	+12V	-12V
ALL MAX	HHHH	4.5A	9.0A	9.0A	0.8A
+5V MAX other MIN	LHLL	0.3A	12.0 A	1.5A	0.0A
+3.3V MAX other MIN	HLLL	16.8 A	0.3 A	1.5A	0.0A
+12V MAX other MIN	LLHL	0.3 A	0.3 A	10.0A	0.0A
ALL MIN	LLLL	0.3 A	0.3 A	1.5A	0.0A

## HOLD-UP TIME (@FULL LOAD)

115V / 60Hz : 17 mSec. Minimum.

230V / 50Hz : 17 mSec. Minimum.

## OUTPUT RISE TIME

(10% TO 90% OF FINAL OUTPUT VALUE, @FULL LOAD)

115V-rms or 230V-rms + 5Vdc : 20ms Maximum

## OVER VOLTAGE PROTECTION

+5V<sub>dc</sub> output: +5.7V<sub>dc</sub> minimum, + 6.5V<sub>dc</sub> maximum

+12V<sub>dc</sub> output: +13.3V<sub>dc</sub> minimum, +15.6V<sub>dc</sub> maximum

+ 3.3V<sub>dc</sub> output: +3.7V<sub>dc</sub> minimum, + 4.5V<sub>dc</sub> maximum

## SHORT CIRCUIT PROTECTION

Output short circuit is defined to be a short circuit load of less than 0.1 ohm.

In the event of an output short circuit condition on +3.3V, +5V or +12V output, the power supply will shutdown and latch off. The power supply shall return to normal operation after the short circuit has been removed and the power switch has been turned off for no more than 2 seconds.

In the event of an output short circuit condition –12V output, the power supply will not be latch off.

The power supply shall return to normal operation as soon as the short circuit has been removed and the power switch has been turned off for no more than 2 seconds.

## OVERLOAD PROTECTION

Overload currents defined as a 10 amp/sec fault current ramp starting from full load, applied to the +3.3V, +5V output, shall not cause that output to exceed 32 amps before the output voltage drops below 0.5 volts and is latched off. The +12V output shall not exceed 20 amps under the same ramp conditions starting at full load before it is latched off.

## POWER GOOD SIGNAL

The power good signal is a TTL compatible signal for the purpose of initiating an orderly star-up procedure under normal input operating conditions. This signal is asserted (low) until +5Vdc has reached 4.75 volts during power up. Characteristics:

TTL signal asserted (low state) : less than 0.5V while sinking 10mA.

TTL signal asserted (high state): greater than 4.75V while sourcing 500uA.

High state output impedance: less or equal to 1Kohm from output to common.

POWER GOOD @ 115/230V, FULL LOAD	100 –500mSec.
POWER FAIL @115/230V, FULL LOAD	1 mSec. minimum

### B.1.2 EFFICIENCY

115 VAC @Full Load	68% minimum
230 VAC @Full Load	68% minimum

### B.1.3 ENVIRONMENTAL REQUIREMENTS

- ④ **Operating temperature range:** 0°C to 50°C
- ④ **Storage temperature range:** -20°C to +80°C
- ④ **Humidity, non-condensing:** 5% ~ 95%RH, Non-Condensing
- ④ **Vibration:** 0.5G, 10~250Hz
- ④ **Shock:** -40G, 11mSec for Storage, -10G, 11mSec for operating

### B.1.4 MTBF

The power supply have a minimum predicted MTBF(MIL-HDBK-217) of 100,000 hours of continuous operation at 25°C, maximum-out load, and nominal AC input voltage.

### B.1.5 SAFETY

TUV

UL 60950

CSA 22.2 Level 3

CE



## Free Manuals Download Website

<http://myh66.com>

<http://usermanuals.us>

<http://www.somanuals.com>

<http://www.4manuals.cc>

<http://www.manual-lib.com>

<http://www.404manual.com>

<http://www.luxmanual.com>

<http://aubethermostatmanual.com>

Golf course search by state

<http://golfingnear.com>

Email search by domain

<http://emailbydomain.com>

Auto manuals search

<http://auto.somanuals.com>

TV manuals search

<http://tv.somanuals.com>