



PORTABLE WIRELESS SPEAKER WITH 3.5MM JACK

MODEL AWS63
INSTALLATION AND OPERATION MANUAL

IMPORTANT INFORMATION

CAUTION

RISK OF ELECTRIC SHOCK.
DO NOT OPEN.

Caution: To reduce the risk of electric shock, do not remove cover (or back). No user serviceable parts inside. Refer servicing to qualified service personnel.

Important Safety Instructions

1. Read these instructions.
2. Keep these instructions.
3. Heed all warnings.
4. Follow all instructions.
5. Clean only with dry cloth.
6. Do not block any ventilation openings. Install in accordance with the manufacturer's instructions.
7. Do not install near any heat sources such as radiators, heat registers, stoves, or other apparatus (including amplifiers) that produce heat.
8. Protect the power cord from being walked on or pinched particularly at plugs, convenience receptacles, and the point where they exit from the apparatus.
9. Unplug this apparatus during lightning storms or when unused for long periods of time.
10. Refer all servicing to qualified service personnel. Servicing is required when the apparatus has been damaged in any way, such as power-supply cord or plug is damaged, liquid has been spilled or objects have fallen into the apparatus, the apparatus has been exposed to rain or moisture, does not operate normally, or has been dropped.

Care and Maintenance

- Always use a soft cloth to clean the speaker and transmitter. Never use any product containing alcohol or other solvents as they may damage the surface.
- Use caution when plugging the power transformers in an AC outlet to avoid the risk of electric shock.
- If the speaker are used outside on a deck or patio, make sure you take them indoors in the event of a rainstorm to prevent possible damage.
- Do not operate or store the system in extreme temperatures (below 32°F/0°C and above 122°F/50°C).
- To avoid electrical shock, use this product with caution near water sources if powered with the AC adapter. Never submerge in water.

Product Information

Keep your sales receipt to obtain warranty parts and service and for proof of purchase. Attach it here and record the serial and model numbers in case you need them. These numbers are located on the product.

Model No.: _____
Purchase Date: _____
Dealer/Address/Phone: _____

INTRODUCTION

The Acoustic Research Portable Wireless Speaker with 3.5mm jack lets you enjoy your music anywhere, at home or on the go, with two ways to connect to your music. The 900MHz wireless transmitter gives you 150ft* of room to roam from your audio source, great for outdoor entertaining at home, with crystal-clear wireless audio. The speaker's 3.5mm jack offers a convenient connection option to use anywhere you go—just connect your MP3 player or smartphone to the speaker, and enjoy!

This manual covers various connection options and detailed operating instructions for making the AR Wireless Speaker System a valued part of your lifestyle. If, after having reviewed the instructions, you have any questions, please call toll-free 1-800-732-6866 or visit www.acoustic-research.com.

*Range may vary according to environment.

TOUR OF THE SPEAKER SYSTEM

Speaker

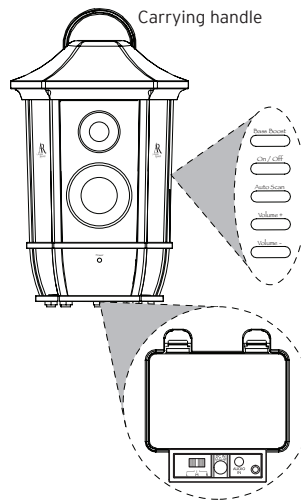

Front Panel

Power indicator blinks when the speaker is first powered on; it turns solid blue when the speaker is tuned to the transmitter

Side Panel

Bass Boost button turns the speaker's bass enhancement on and off

On/Off button turns the speaker on and off

Auto Scan button rescans for the transmitter's signal

Volume +/- buttons adjust the volume level

Bottom Panel

L/M/R switch determines if the speaker plays sound in mono as a stand-alone speaker, or plays the left or right track in a stereo pair with an additional AWS63

DC IN receives the small round end of the included 9V 1200mA AC power adapter; remove the protective cover to insert the adapter

AUDIO IN connects directly to your MP3 player, smartphone, or other portable audio device, using the 3.5mm audio in cable provided

Battery Compartment Cover remove to install 6 AA batteries

Transmitter

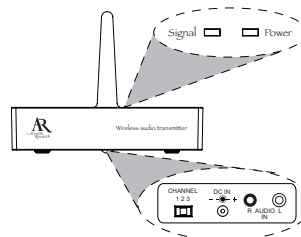

Top Panel

Signal indicator lights green when the audio is present and the transmitter is broadcasting

Power indicator lights when the transmitter is on

Back Panel

CHANNEL 1 2 3 lets you find the best transmission frequency for your environment

DC IN jack receives the small round end of the included 12V 200mA AC power adapter

AUDIO IN (R / L) connects to your sound source using one of the connection options shown here

TOUR OF THE SPEAKER SYSTEM

Included Accessories

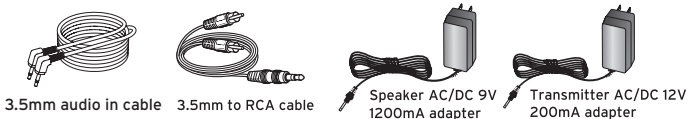

Note: These power units should be plugged in so that they stay vertical or lie flat.

CONNECTING THE SPEAKER SYSTEM

Powering the Transmitter

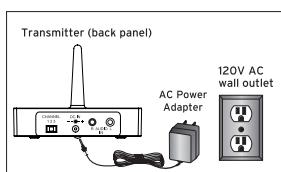

Connect the small, round plug from the transmitter AC power adapter to the transmitter's DC IN jack. Plug the other end of the transmitter AC power adapter into any standard 120V AC wall outlet.

Note: Be sure to use the AC power adapter rated 12V DC 200 mA (it has the smaller diameter plug).

Note: There is no transmitter ON/OFF switch. The transmitter is designed to be left plugged in and powered at all times. If you will not be using the AWS63 for an extended period of time, unplug the transmitter AC power adapter.

Connecting to an Audio Source

Connecting to an MP3 player, smartphone, or other portable audio device

This speaker offers two ways to listen to audio from a portable audio device: using the wireless transmitter or connecting directly to the audio source.

Using the wireless transmitter

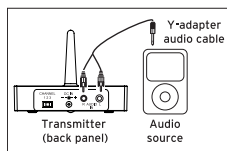

1. Plug the stereo plugs on the provided Y-adaptor audio cable into the AUDIO IN jacks on the back of the transmitter.
2. Plug the mini-plug end of the provided Y-adaptor into the headphone output of your MP3 player or other portable audio device.

Using a direct connection

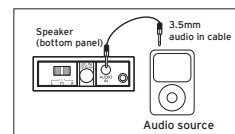

1. Connect one end of the provided 3.5mm audio in cable to the AUDIO IN jack on the bottom of the speaker.
2. Connect the other end of the cable to the headphone output on your MP3 player or other portable audio device.

Warning: This product is designed to work with line level outputs or headphone outputs only. **DO NOT** connect it directly to speaker outputs as it will permanently damage the transmitter.

Connecting to an A/V Receiver

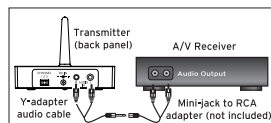

1. Plug the stereo plugs on the provided Y-adaptor audio cable into the AUDIO IN jacks on the back of the transmitter (make sure to match the colors on the plugs and jacks).
2. Plug the mini-plug end of the provided Y-adaptor into a mini-jack to RCA adapter (not included).

3. Connect the stereo plugs on the mini-jack to RCA adapter to the corresponding left and right audio outputs of your A/V receiver, amp, or other audio source.

CONNECTING THE SPEAKER SYSTEM

Powering the Speaker

There are two options to power your wireless speaker: using the included AC power adapter or using 6 AA batteries (not included).

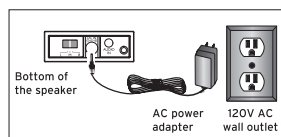

AC Power Adapters

1. Insert the small, round plug from the speaker AC power adapter into the DC IN jack on the bottom of the speaker.
2. Plug the other end of the speaker AC power adapter into any standard 120V AC wall outlet.

Note: Be sure to use the speaker AC power adapter rated 9V DC 1200 mA.

Warning: This product is water-resistant, not waterproof. Avoid prolonged exposure to wet environments, such as rain, mist, dew, etc. In other words, you can take it out, just don't leave it out. If you plan to use the speaker in a humid or wet environment, we recommend powering it with batteries instead of with the power adapter.

AA Batteries

1. Remove the battery compartment cover on the bottom of the speaker.
2. Insert six (6) AA batteries (not included) into the speaker following the polarity ("+" and "-") as diagrammed inside the battery compartment.
3. Replace the battery compartment cover on the bottom of the speaker.

Note: Place the rubber cap in the speaker power input jack when using batteries.

DO NOT mix batteries with different chemistry types (for example, a zinc battery with an alkaline battery). **DO NOT** mix new and used batteries. **DO NOT** leave batteries installed in the product when not in use for long periods. Always remove old, weak or worn-out batteries promptly and recycle or dispose of them in accordance with local and national regulations.

USING THE SPEAKER SYSTEM

Adjusting the Transmitter

1. Turn on your audio source (for example, A/V receiver, MP3 player, stereo, etc.) and play music at a normal listening volume.

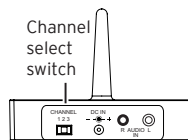

2. Set the channel select switch on the back of the transmitter to one of the transmitter's three broadcast frequencies: 1, 2 or 3. If you experience poor reception or interference, try choosing a different frequency by moving the channel select switch to another position.

When the transmitter is receiving an audio signal and is ready, the SIGNAL indicator turns solid green.

Note

If the SIGNAL indicator on the transmitter does not turn on, please check the following:

- Confirm the transmitter AC power adapter is securely connected.
- Confirm the cable from the transmitter is securely connected to the audio source output (MP3 player, A/V receiver, etc.).
- Confirm the audio source is playing audio and is turned up.

USING THE SPEAKER SYSTEM

Adjusting the Speaker

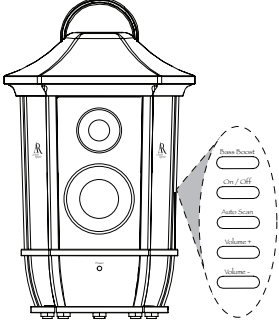

1. Press the Power button on the side of the speaker to turn it on.

If you're using the wireless transmitter, the indicator light on the front of the speaker blinks while the speaker is tuning to the transmitter. This indicator light turns solid blue when the speaker is tuned to the transmitter--you should hear sound coming from the speaker now.

Note: If the speaker is not tuned or if the transmitter is not connected properly, the indicator light will continue blinking. If this occurs, please see the Troubleshooting section of this manual.

If you're using a direct connection to your audio source (via audio cable), all you need to do is start playback on your audio source, you should start hearing sound from the speaker.

IMPORTANT: The indicator light on the front of the speaker indicates the status of the wireless connection only. If you're not using the transmitter (or if you're out of range of the transmitter) it will keep blinking until it finds the transmitter. This is normal.

2. Adjust the volume on the speaker as desired.

Note: Make sure your audio source is turned up at least to 75% of full volume (but not so loud that the sound becomes distorted).

3. If you're using the wireless transmitter, set up the speaker for mono or stereo operation using the switch on the bottom of the AWS63 speaker.

a) Monaural operation: The monaural mode (mono) is recommended when using a single AWS63 by itself. For monaural operation, set the L/M/R switch to "M" on each speaker.

b) Stereo operation: You need an additional AWS63 speaker for the stereo option. Set the L/M/R switch to "L" on the speaker located to the left from the listener, and set the other speaker to the "R" position.

Notes:

The speaker automatically retunes if it loses the transmitter's signal. You can also press the AutoScan button on the side of the speaker to retune the speaker at any time.

The transmitter turns off automatically if there is no audio signal present for a prolonged period. Interference in the form of static and/or distortion can sometimes be heard. If this occurs, confirm the transmitter/speaker adjustments and indicators. If the problem persists, refer to the Troubleshooting section of this manual.

TURNING THE SPEAKER OFF

1. Press the On/Off button on the side of the speaker to turn the speaker off.
2. Confirm that the speaker is off by verifying that the indicator light on the speaker's front panel is no longer illuminated.

MORE HELPFUL INFORMATION

About Fixed-Level Audio Outputs

A fixed-level, or line-level, audio output is considered ideal since it provides an audio signal unchanged by adjustments to the audio source volume control.

Hint: Fixed-level audio outputs from stereo receivers/amps will typically be designated as Tape (or Record) outputs or DVR/DVD-R audio output connections.

Fixed-level outputs from TVs are usually marked as 'Constant,' 'Fixed,' or 'Select.' If they are not marked as such, they are probably variable outputs (see "About Variable-Level Audio Outputs" on the next page). Outputs from DVD players are almost always fixed.

Hint: When connecting to the audio outputs of a DVD player, remember that the DVD player must be showing a TV channel for sound to be produced.

About Variable-Level Audio Outputs:

A variable-level output, such as a headphone jack or certain RCA-type outputs, provides an audio signal that changes with the volume level set on the audio source. As the volume of the audio source is adjusted up and down, so is the audio signal strength sent to the transmitter. This can affect the quality of sound generated by the speaker, and may require an adjustment of the volume level of the audio source to produce a signal strong enough for the transmitter.

Hint: On most bookshelf-type or compact stereo systems, inserting a headphone plug into the headphone jack results in automatic cutoff of the regular, or hard-wired speakers.

Hint: Most TVs, regardless of age or price, have variable outputs. If you are unsure which of your TV audio outputs is fixed, refer to the TV instruction manual. Some TVs have outputs that can switch between variable and fixed. When given a choice, fixed is always recommended.

TROUBLESHOOTING

The following troubleshooting guide takes you through some of the more common problems associated with the installation and/or operation of a wireless system. If the problem persists, please call toll-free at 1-800-732-6866 or visit www.acoustic-research.com

Issue:	Cause and solution:
No sound	<ul style="list-style-type: none">• Check that the transmitter AC power adapter is fully inserted into the wall outlet and the power cord from the AC adapter is firmly connected to the transmitter power input jack.• Confirm that the speaker is turned on and tuned to the transmitter--the indicator light on the front of the speaker should be solid blue (not blinking).• If you're using the power adapters, confirm that both (for the speaker and for the transmitter) are fully inserted into their wall outlets and the adapter power cords are firmly connected to the power input jacks on the transmitter or speaker.• or• If you're using batteries for the speaker, check that they are fresh and inserted with correct polarity (+, -).• Check that the audio source component (stereo, MP3 player, etc.) is turned on and transmitting sound as it normally should.• Make sure the volume on your audio source is turned up.• Check that the speaker volume is turned up.• If you are using a Tape 2 Monitor output from your receiver/amp as the audio output, check that you have pressed the Tape Monitor/Tape 2 button on the front of the receiver. This will turn on the Tape 2 outputs, which may not have been active.
No sound/ distortion/ static	<ul style="list-style-type: none">• When using battery power, make sure the batteries are fresh and replace if necessary.• Check that the speaker's indicator light is solid blue (not blinking) when an audio source is connected to the transmitter• Change the position of the channel select switch (1, 2 or 3) to change the operating frequency. Then press the AutoScan button on the speaker's back panel to make the speaker retune.• Change the location of the transmitter. Place it as high and away from obstructions as possible. Avoid placing the transmitter directly on top of or behind a TV.• Move the transmitter and speaker closer together. Sending the signal through certain materials, such as glass, tile, and metal, can decrease the effective transmitting distance of the system.

SPECIFICATIONS

Transmitter

- Omni-directional 900MHz broadcast
- Effective transmitting range: up to 150 ft. (45m)*
- Phase-locked loop circuitry (PLL)
- Automatic level control (ALC)
- 3 selectable broadcast frequencies
- Stereo audio input

Speaker

- Push-button, auto-lock tuning
- 2-way acoustic design: 2" tweeter, 3" woofer
- 5 Watt RMS internal amplifier
- Omni-directional sound
- Frequency response: 40Hz - 15kHz
- Left/Mono/Right switch
- Operates using supplied AC adapter or six (6) AA batteries (not included)

*Maximum range; results may vary according to environment.

FCC Statement

This equipment has been tested and found to comply with the limits for a Class B digital device, pursuant to part 15 of the FCC Rules. These limits are designed to provide reasonable protection against harmful interference in a residential installation. This equipment generates, uses, and can radiate radio frequency energy and, if not installed and used in accordance with the instructions, may cause harmful interference to radio communication. However, there is no guarantee that interference will not occur in a particular installation. If this equipment does cause harmful interference to radio or television reception, which can be determined by turning the equipment off and on, the user is encouraged to try to correct the interference by one or more of the following measures:

- Reorient or relocate the receiving antenna.
- Increase the separation between the equipment and receiver.
- Connect the equipment into an outlet on a circuit different from that to which the receiver is connected.
- Consult the dealer or an experienced radio/TV technician for help.

FCC Regulations state that unauthorized changes or modifications to this equipment may void the user's authority to operate it.

Industry Canada Regulatory Information

This device complies with RSS-210 of the Industry Canada Rules. Operation is subject to the following two conditions: 1) this device may not cause interference and 2) this device must accept any interference, including interference that may cause undesired operation of the device.

This class B digital apparatus complies with Canadian ICES-003.

IC Radiation Exposure Statement: This equipment complies with IC radiation exposure limits set forth for an uncontrolled environment.

12 MONTH LIMITED WARRANTY

Audiovox Electronics Corporation (the "Company") warrants to the original retail purchaser of this product that should this product or any part thereof, under normal use and conditions, be proven defective in material or workmanship within 12 months from the date of original purchase, such defect(s) will be repaired or replaced (at the Company's option) without charge for parts and repair labor. To obtain repair or replacement within the terms of this Warranty, the product along with any accessories included in the original packaging is to be delivered with proof of warranty coverage (e.g. dated bill of sale), specification of defect(s), transportation prepaid, to the Company at the address shown below. Do not return this product to the Retailer.

This Warranty is not transferable and does not cover product purchased, serviced or used outside the United States or Canada. The warranty does not extend to the elimination of externally generated static or noise, to costs incurred for the installation, removal or reinstallation of the product.

The warranty does not apply to any product or part thereof which, in the opinion of the company, has suffered or been damaged through alteration, improper installation, mishandling, misuse, neglect, accident or exposure to moisture. This warranty does not apply to damage caused by an AC adapter not provided with the product, or by leaving non-rechargeable batteries in the product while plugged into an AC outlet.

THE EXTENT OF THE COMPANY'S LIABILITY UNDER THIS WARRANTY IS LIMITED TO THE REPAIR OR REPLACEMENT PROVIDED ABOVE AND, IN NO EVENT, SHALL THE COMPANY'S LIABILITY EXCEED THE PURCHASE PRICE PAID BY PURCHASER FOR THE PRODUCT.

This Warranty is in lieu of all other express warranties or liabilities. ANY IMPLIED WARRANTIES, INCLUDING ANY IMPLIED WARRANTY OF MERCHANTABILITY OR FITNESS FOR A PARTICULAR PURPOSE, SHALL BE LIMITED TO DURATION OF THIS WARRANTY. ANY ACTION FOR BREACH OF ANY WARRANTY HEREUNDER, INCLUDING ANY IMPLIED WARRANTY, MUST BE BROUGHT WITHIN A PERIOD OF 24 MONTHS FROM THE DATE OF ORIGINAL PURCHASE. IN NO CASE SHALL THE COMPANY BE LIABLE FOR ANY CONSEQUENTIAL OR INCIDENTAL DAMAGES WHATSOEVER. No person or representative is authorized to assume for the Company any liability other than expressed herein in connection with the sale of this product.

Some states/provinces do not allow limitations on how long an implied warranty lasts or the exclusion or limitation of incidental or consequential damage so the above limitations or exclusions may not apply to you. This Warranty gives you specific legal rights and you may also have other rights which vary from state/province to state/province.

U.S.A.: Audiovox Electronics Corp., 150 Marcus Blvd., Hauppauge, New York 11788

CANADA: Audiovox Return Center, c/o Genco, 6685 Kennedy Road, Unit #3 Door 16, Mississauga Ontario L5T 3A5

Free Manuals Download Website

<http://myh66.com>

<http://usermanuals.us>

<http://www.somanuals.com>

<http://www.4manuals.cc>

<http://www.manual-lib.com>

<http://www.404manual.com>

<http://www.luxmanual.com>

<http://aubethermostatmanual.com>

Golf course search by state

<http://golfingnear.com>

Email search by domain

<http://emailbydomain.com>

Auto manuals search

<http://auto.somanuals.com>

TV manuals search

<http://tv.somanuals.com>