

User's Guide

11970 SERIES HARMONIC MIXERS (K, A, Q, U, V, and W Models)



Agilent Technologies

Manufacturing Part Number: 11970-90031

Supersedes 11970-90030

Printed in USA

October 2003

© Copyright 1992, 1999, 2001–2003 Agilent Technologies, Inc.

Notice

The information contained in this document is subject to change without notice.

Agilent Technologies makes no warranty of any kind with regard to this material, including but not limited to, the implied warranties of merchantability and fitness for a particular purpose. Agilent Technologies shall not be liable for errors contained herein or for incidental or consequential damages in connection with the furnishing, performance, or use of this material.

Certification

Agilent Technologies certifies that this product met its published specifications at the time of shipment from the factory. Agilent Technologies further certifies that its calibration measurements are traceable to the United States National Institute of Standards and Technology, to the extent allowed by the Institute's calibration facility, and to the calibration facilities of other International Standards Organization members.

Warranty

This Agilent Technologies instrument product is warranted against defects in material and workmanship for a period of one year from date of shipment. During the warranty period, Agilent Technologies will, at its option, either repair or replace products which prove to be defective.

For warranty service or repair, this product must be returned to a service facility designated by Agilent Technologies. Buyer shall prepay shipping charges to Agilent Technologies and Agilent Technologies shall pay shipping charges to return the product to Buyer. However, Buyer shall pay all shipping charges, duties, and taxes for products returned to Agilent Technologies from another country.

Agilent Technologies warrants that its software and firmware designated by Agilent Technologies for use with an instrument will execute its programming instructions when properly installed on that instrument. Agilent Technologies does not warrant that the operation of the instrument, or software, or firmware will be uninterrupted or error-free.

LIMITATION OF WARRANTY

The foregoing warranty shall not apply to defects resulting from improper or inadequate maintenance by Buyer, Buyer-supplied software or interfacing, unauthorized modification or misuse, operation outside of the environmental specifications for the product, or improper site preparation or maintenance.

NO OTHER WARRANTY IS EXPRESSED OR IMPLIED. AGILENT TECHNOLOGIES SPECIFICALLY DISCLAIMS THE IMPLIED WARRANTIES OF MERCHANTABILITY AND FITNESS FOR A PARTICULAR PURPOSE.

EXCLUSIVE REMEDIES

THE REMEDIES PROVIDED HEREIN ARE BUYER'S SOLE AND EXCLUSIVE REMEDIES. AGILENT TECHNOLOGIES SHALL NOT BE LIABLE FOR ANY DIRECT, INDIRECT, SPECIAL, INCIDENTAL, OR CONSEQUENTIAL DAMAGES, WHETHER BASED ON CONTRACT, TORT, OR ANY OTHER LEGAL THEORY.

Assistance

Product maintenance agreements and other customer assistance agreements are available for Agilent Technologies products.

For any assistance, contact your nearest Agilent Technologies Sales and Service Office listed on [page 77](#).

This guide uses the following conventions:

Instrument Key This represents a key physically located on the instrument, or a key with a label that is determined by the instrument firmware.

Screen Text This indicates text displayed on the spectrum analyzer screen.

1. General Information	
Introduction	8
Mixers Covered by Manual	8
11970 Series Harmonic Mixers	9
Options	9
Spectrum Analyzer Retrofit Requirements	9
Specifications	11
Equipment Supplied	11
Environmental Limitations	11
2. Operation	
Introduction	18
Operating Precautions	18
Getting Started	19
Mixer Connections	19
Using a Conversion-Loss Data Disk with the ESA or PSA Series Analyzers	21
Loading Data	21
Viewing Data	21
Using the Mixers with the E4407B Spectrum Analyzer (Option AYZ)	22
Set up the equipment	22
Using the Mixers with the E4440A, E4446A, or E4448A PSA Series Spectrum Analyzer (Option AYZ)	26
Set up the equipment	26
Using the Mixers with the 856X Series Spectrum Analyzers	30
Set up the equipment	30
Select the Frequency Band	31
Save the average conversion-loss value	32
Signal Identification	33
Identify signals with the frequency-shift method	34
Identify signals in wide frequency spans	36
Using the Mixers with MMS Analyzers	38
Preliminary Operation	38
Operation	39
Conversion Loss Versus Frequency Correction	43
Using the Mixers with the 8566B Spectrum Analyzer	45
Set up the equipment	45
Amplitude Calibration	46
Signal Identification	47
3. Performance Tests	
Introduction	50
Test Record	50
Performance Test Procedures	51
Description	51
Conversion Loss and Frequency Response	57
Specifications	57
Description	58
AVERAGE NOISE LEVEL TEST	68

Contents

Specification	68
Description	68
4. Service	
Maintenance	74
Repairs	74
Replaceable Parts	74
Circuit Description	74

1 General Information

Introduction

The Agilent Models 11970K, 11970A, 11970Q, 11970U, 11970V and 11970W are general-purpose harmonic mixers with very flat frequency response characteristics and low conversion loss. Collectively, they cover the frequency range of 18 to 110 GHz. The 11970K covers the 18 - 26.5 GHz range; the 11970A, the 26.5 - 40 GHz range; the 11970Q, the 33 - 50 GHz range; the 11970U, the 40 - 60 GHz range; the 11970V, the 50 - 75 GHz range; and the 11970W, the 75 - 110 GHz range.

The overall local oscillator (LO) frequency range of the 11970 Series Mixers is 3.0 to 6.1 GHz. Each of the mixers employs a different LO harmonic, and as a result has a different optimum LO range within the overall LO range of the series.

The 11970 Series Mixers use the Agilent 11975A Amplifier to raise the LO power to their required LO input level of 14 to 18 dBm. By taking advantage of the power leveling capability of the 11975A, the mixers are able to achieve maximum measurement accuracy (at optimum LO input level of 14.5 to 16 dBm).

A label on the end of each mixer shows a Conversion Loss Calibration table printed especially for that particular mixer. An 8-1/2 by 11-inch calibration table shipped with the mixer provides a larger, easier to read, version of the same table shown on the label, plus a graph which shows the conversion loss and reference level offset across the mixer's frequency range. This calibration table must be employed for absolute amplitude measurements. Also supplied with each mixer are five screws (four required) for attaching the mixer RF input flange to the waveguide.

Mixers Covered by Manual

Serial Numbers

Attached to your mixer, is a label which shows both the mixer model number and its serial number (two parts). The first four digits and the letter of the serial number are the serial number prefix; the last five digits are the suffix. The contents of this manual apply to mixers with the serial number prefixes listed under "Serial Number Prefixes" on the title page of this manual.

11970 Series Harmonic Mixers

Figure 1-1.

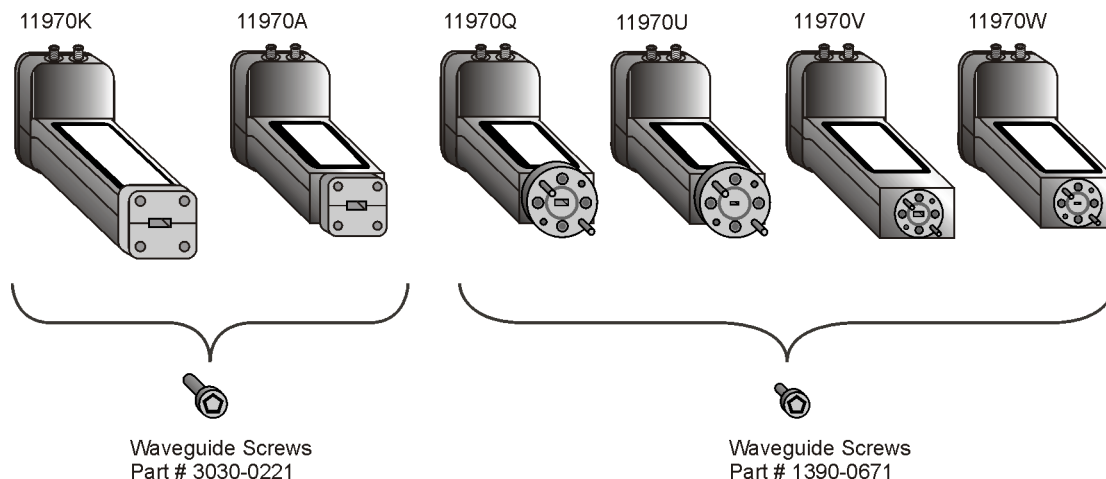

ac31a

Options

Option 009, shown in [Figure 1-2](#), is a Mixer Connection Kit. It includes three low-loss SMA cables (Part Number 5061-5458), one hex-head balldriver (Part Number 8710-1539) for tightening the waveguide connector screws, and one 5/16-inch open-end wrench (Part Number 8710-0510) for use on the SMA connectors.

Spectrum Analyzer Retrofit Requirements

- The 11970 Series Mixers are fully compatible with all 8566B Spectrum Analyzers.
- 856x Series portable spectrum analyzers with options 002 (tracking generator) and 327 (no IF IN on front panel) do not have external mixing capability.
- 856x Series Portable Spectrum Analyzers require option 008, or FW date code ≤ 920528 , for signal identification functionality.
- Agilent E4407B spectrum analyzers require option AYZ (LO Out and IF IN connections).
- MMS analyzers using 11970 series mixers must have a front end model 70907A, 70907B, 70909A, or 70910A, as well as a 70900A/B with firmware new enough for those modules:

Model	FW Date Code: (or newer)
70907A	- 860203
70907B	- 900314
70909A	- 910802
70910A	- 910802

- PSA Series E4440A, E4446A, and E4448A spectrum analyzers require Option AYZ (LO OUT and IF IN connectors). The E4443A and E4445A do not support external mixing.

Figure 1-2. Mixer Connection Kit, Option 009

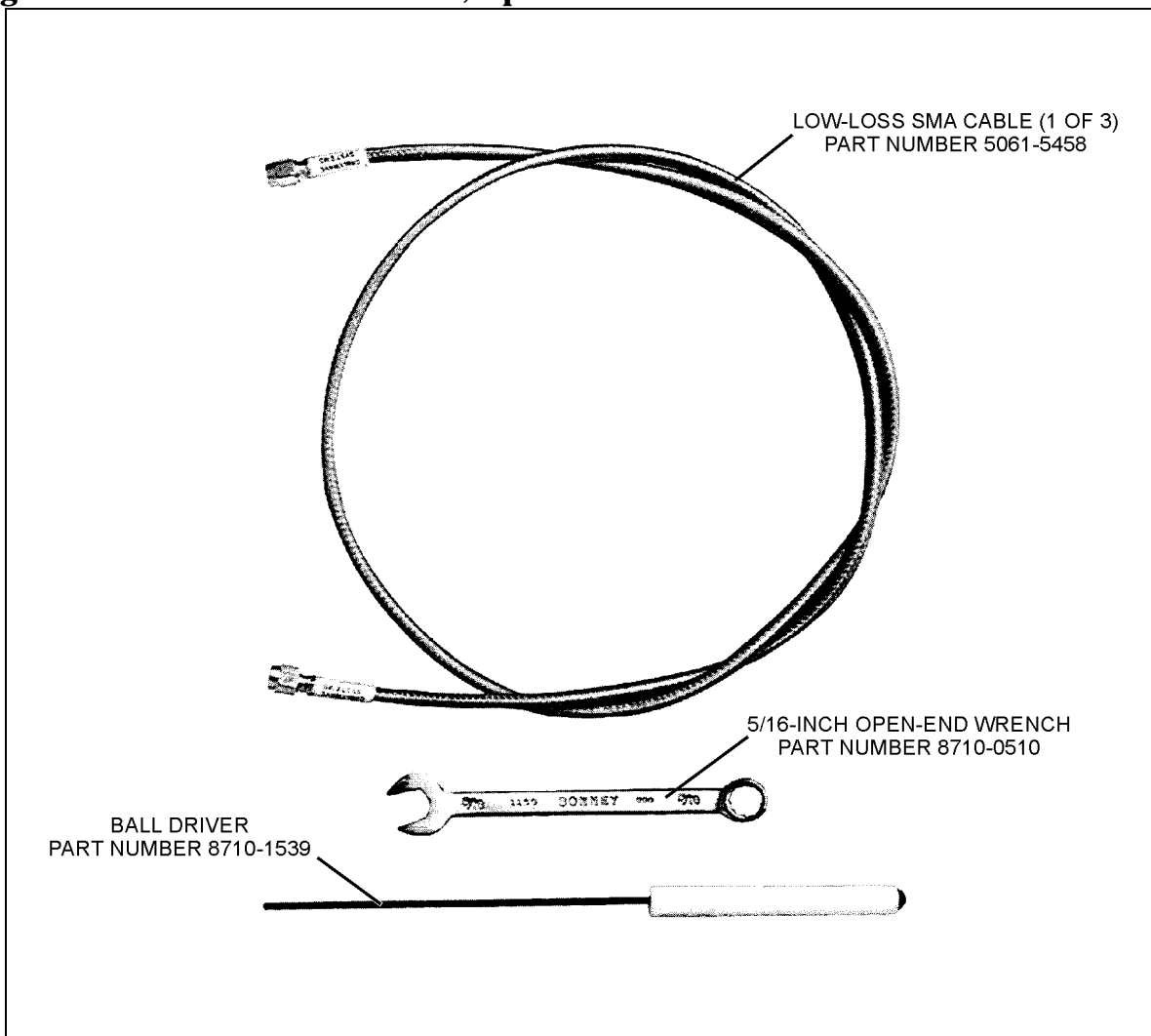

art2

Specifications

Specifications for the 11970 Series Mixers are listed in [Table 1-1](#). These are the performance standards against which the mixers are tested (performance tests are provided in [Chapter 3](#), “Performance Tests,”). Typical or nominal operating values are listed in [Table 1-2](#).

NOTE Supplemental characteristics are included only as additional information; they are not specifications.

Equipment Supplied

Waveguide Connector Screws

Five hex-head screws are supplied with each mixer. Four are required to make the mixer-to-waveguide connection, one is a spare. Use ONLY the screws supplied to attach the mixer to the waveguide. Because of slight differences in the way the mixers couple with the waveguide, the square-flange mixers (11970K and 11970A) and the round-flange mixer (11970Q, 11970U, 11970V and 11970W) require different screws.

If your mixer has a square waveguide flange, use four hex-head screws with Part Number 3030-0221. If it has a round waveguide flange, use four hex-head captive screws with Part Number 1390-0671. The special balldriver hex screwdriver available in the Option 009 Mixer Connector Kit simplifies installation of the waveguide connector screws.

NOTE See [Chapter 4](#), “Service,” for a list of replacement parts.

Environmental Limitations

The 11970 Series Mixers meet or exceed the environmental requirements of MIL-T-28800C, Type III, Class 3, Style C. Specific environmental qualifications for the mixers are as follows:

Temperature, Non-operating: -40°C to 75°C

Temperature, Operating: 0°C to 55°C

Relative Humidity: 95 ±5% (up to 30°C)

Altitude, Non-operating: Less than 12,195 meters (40,000 ft.)

Altitude, Operating: Less than 3,048 meters (10,000 ft.)

Maximum Vibration Levels: 2 G's at 5 to 2000 Hz

Maximum Shock: 30 G's

Table 1-1 11970 Series Specifications

NOTE

Unless otherwise stated, all specifications apply for an IF of 321.4 MHz and for RF input amplitudes of less than -20 dBm.

GENERAL

LO Amplitude Range: 14 to 18 dBm¹

Bias Requirements: None

Calibration Accuracy:

Maximum CW RF Input Level:

11970K/A/Q/U:
± 2.0 dB with LO amplitude range of 14.5 to 16 dBm

20 dBm (100mW)

11970V/W:
± 2.2 dB with LO amplitude range of 14.5 to 16 dBm

Maximum Peak Pulse Power:
24 dBm with < 1µsec pulse (avg. power: + 20 dBm)

11970K/A/Q/U:
± 3.0 dB with LO amplitude range of 16 to 18 dBm

Environmental:
Meets MIL-T-28800C, Type III, Class 3, Style C

11970V/W: ± 3.2 dB with LO amplitude range of 16 to 18 dBm

IF/LO Connectors:
SMA female

Table 1-1 11970 Series Specifications

NOTE	
Unless otherwise stated, all specifications apply for an IF of 321.4 MHz and for RF input amplitudes of less than -20 dBm.	
MODEL 11970K	MODEL 11970A
RF Frequency Range: 18 - 26.5 GHz	RF Frequency Range: 26.5 - 40 GHz
LO Harmonic Number: 6	LO Harmonic Number: 8
LO Input Frequency Range: 2.95 - 4.36 GHz	LO Input Frequency Range: 3.27 - 4.96 GHz
Maximum Conversion Loss: 24 dB	Maximum Conversion Loss: 26 dB
8566B Noise Level at 1 kHz Bandwidth, and 14.5 to 16 dBm LO Input Power: -105 dBm	8566B Noise Level at 1 kHz Bandwidth, and 14.5 to 16 dBm LO Input Power: -102 dBm
Frequency Response at 14.5 to 16 dBm LO Input Power: ± 1.9 dB	Frequency Response at 14.5 to 16 dBm LO Input Power: ± 1.9 dB
Frequency Response at 14 to 18 dBm LO Input Power: ± 2.8 dB	Frequency Response at 14 to 18 dBm LO Input Power: ± 2.8 dB
MODEL 11970Q	MODEL 11970U
RF Frequency Range: 33 - 50 GHz	RF Frequency Range: 40 - 60 GHz
LO Harmonic Number: 10	LO Harmonic Number: 10
LO Input Frequency Range: 3.27 - 4.97 GHz	LO Input Frequency Range: 3.97 - 5.97 GHz
Maximum Conversion Loss: 28 dB	Maximum Conversion Loss: 28 dB
8566B Noise Level at 1 kHz Bandwidth, and 14.5 to 16 dBm LO Input Power: -101 dBm	8566B Noise Level at 1 kHz Bandwidth, and 14.5 to 16 dBm LO Input Power: -101 dBm
Frequency Response at 14.5 to 16 dBm LO Input Power: ± 1.9 dB	Frequency Response at 14.5 to 16 dBm LO Input Power: ± 1.9 dB
Frequency Response at 14 to 18 dBm LO Input Power: ± 2.8 dB	Frequency Response at 14 to 18 dBm LO Input Power: ± 2.8 dB

General Information

Table 1-1 11970 Series Specifications

NOTE	
Unless otherwise stated, all specifications apply for an IF of 321.4 MHz and for RF input amplitudes of less than -20 dBm.	
MODEL 11970V	MODEL 11970W
RF Frequency Range: 50 - 75 GHz	RF Frequency Range: 75 - 110 GHz
LO Harmonic Number: 14	LO Harmonic Number: 18
LO Input Frequency Range: 3.55 - 5.33 GHz	LO Input Frequency Range: 4.15 - 6.09 GHz
Maximum Conversion Loss: 40 dB	Maximum Conversion Loss: 46 dB
8566B Noise Level at 1 kHz Bandwidth, and 14.5 to 16 dBm LO Input Power: -92 dBm	8566B Noise Level at 1 kHz Bandwidth, and LO Input Power: - 85 dBm
Frequency Response at 14.5 to 16 dBm LO Input Power: ± 2.1 dB	Frequency Response at 14.5 to 16 dBm LO Input Power: ± 3.0 dB ²
Frequency Response at 14 to 18 dBm LO Input Power: ± 2.8 dB	Frequency Response at 14 to 18 dBm LO Input Power: ± 4.0 dB

1. The 11975A Amplifier, or a similar amplifier, can be used to provide sufficient LO power (14 to 18 dBm) to the mixers. Leveled power capability of 16 dBm, as is available with the 11975A, is necessary to achieve the maximum amplitude accuracy with the mixers. Assuming the 1 meter cables supplied with the instrument are used, only the 8566B LO output requires amplification. However, if longer or lower quality cables are used LO amplification may be necessary.
2. Typically ± 2.5 dB with LO supplied by 8566B Spectrum Analyzer, 11975A Amplifier set to 16 dBm, and P/N 5061-5458 SMA cables.

Table 1-2 11970 Supplemental Characteristics

NOTE Supplemental characteristics are included only as additional information; they are not specifications.	
3 dB IF Bandwidth: DC to 1.3 GHz	Odd Order Mixing Product Suppression: 11970K/A/Q/U: >20 dB 11970V/W: >15 dB
Spectrum Analyzer Absolute Amplitude Accuracy (using calibration data with a 14.5 to 16 dBm LO): 11970K, 18 - 26.5 GHz: ±3.2 dB 11970A, 26.5 - 40 GHz: ±3.2 dB 11970Q, 33 - 50 GHz: ±3.2 dB 11970U, 40 - 60 GHz: ±3.2 dB 11970V, 50 - 75 GHz: ±3.4 dB 11970W: 75 - 110 GHz: ±3.4 dB	Gain Compression Level (<1 dB): 11970K: -3 dBm 11970A: -5 dBm 11970Q: -7 dBm 11970U: -7 dBm 11970V: -3 dBm 11970W: -1 dBm
RF Input SWR: 11970K/A/Q/U: <2.2:1 11970V/W: <2.6:1	5061-5458 Cable Insertion Loss: .8 dB at 2 GHz 1.1 dB at 6 GHz

General Information

PHYSICAL CHARACTERISTICS					
Model	Flange ¹	Weight	X	Y	Z
11970K	UG-595/U WR-42	0.17 kg 0.36 lb	36 mm 1.4 in	51 mm 2.0 in	90 mm 3.5 in
11970A	UG-599/U WR-28	0.14 kg 0.32 lb	36 mm 1.4 in	51 mm 2.0 in	71 mm 2.8 in
11970Q	UG-383/U WR-22	0.14 kg 0.32 lb	36 mm 1.4 in	51 mm 2.0 in	76 mm 3.0 in
11970U	UG-383/U-M WR-19	0.14 kg 0.32 lb	36 mm 1.4 in	51 mm 2.0 in	76 mm 3.0 in
11970V	UG-385/U WR-15	0.14 kg 0.32 lb	36 mm 1.4 in	51 mm 2.0 in	76 mm 3.0 in
11970W	UG-387/U-M WR-10	0.14 kg 0.32 lb	36 mm 1.4 in	51 mm 2.0 in	76 mm 3.0 in

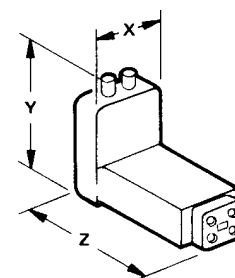

1. Waveguide attachment screws enter blind holes in the flanges of the mixers.

2 Operation

Introduction

This section provides information on how to make effective use of the 11970 mixers.

Operating Precautions

Refer to the sections below for specific parameters to follow prior to mixer operation.

WARNING **Do not exceed the maximum ratings listed below or permanent damage to the mixer will result.**

RF Input Power

Use the following parameters:

CW: No greater than 20 dBm

Pulse: No greater than 24 dBm at < 1 mSec

Average: No greater than 20 dBm

LO Input Power

Make sure the LO input power is no greater than 20 dBm.

Electrostatic Discharge

When installing the mixer, you must always connect the SMA cables to the spectrum analyzer and LO amplifier BEFORE connecting them to the mixer. This will minimize the danger of an electrostatic discharge damaging the mixer diodes.

11975A ALC Switch

BEFORE using the 11975A Amplifier to increase the LO input power, set the amplifier ALC switch to the ON position. When this switch is in the OFF position the LO power can be greater than 20 dBm. This level of LO power can destroy the mixer diodes. The ALC switch is on the amplifier rear panel.

Waveguide Protective Foam

Do not remove, displace, or damage the white, nonconductive foam installed in the open end of the waveguide. Since the mixer is amplitude calibrated with this foam in place, tampering with it affects the calibration.

Getting Started

The 11970 series of millimeter wave mixers have no bias or back-short adjustments. 11970 Mixers require an LO power of 14 to 18 dBm at the LO input. If the spectrum analyzer used with the 11970 does not have sufficient LO power, an 11975A Amplifier or an equivalent is required to increase this power.

CAUTION Before connecting the 11975A Amplifier, set its rear panel ALC switch to ON. Failure to do this can damage the mixer.

Mixer Connections

With the three SMA cables (Part Number 5061-5458, each) provided in the Option 009 Mixer Connection Kit, connect the 11970 Mixer, the spectrum analyzer, and the 11975A Amplifier. An example connection for an 8566B Spectrum Analyzer is shown in Figure 2-1.

NOTE The example below shows an 8566B analyzer, other spectrum analyzers do not require the amplifier and third SMA cable.

Figure 2-1. 11970 Mixer Connections

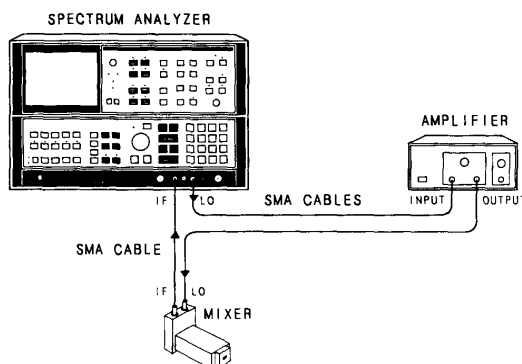

Leave the waveguide flange cap on whenever the mixer is not connected to a device under test. This protects the flange mating surface from scratches, which can degrade the mixer's performance. Use an appropriate waveguide attenuator if the output power of the unit under test exceeds the RF Input Power indicated in the specifications.

If you are using an 11970Q, 11970U, 11970V or 11970W Mixer, and the shoulder of its waveguide flange is not properly aligned with the flange of the device under test, amplitude measurement errors can result. To ensure proper alignment, tighten each of the four flange screws in turn by small amounts, moving clockwise around the flange.

NOTE 11970K and 11970A Mixers require flange screws that are different from those used with the 11970Q, 11970U, 11970V and 11970W; 11970K and 11970A use Part Number 3030-0221 (#4-40 hex head screw). 11970Q, 11970U, 11970V and 11970W use Part Number 1390-0671 (#4-40 hex head captive screw).

Using a Conversion-Loss Data Disk with the ESA or PSA Series Analyzers

The conversion-loss data for your mixer can be quickly loaded in the memory of an ESA or PSA series analyzer from a floppy disk. The following process works with the floppy disk provided by the factory with your new mixer, or with one that you have stored the correction data. This process eliminates the time consuming and sometimes error-prone process of manually entering the data from a table.

Loading Data

1. Insert the conversion-loss data disk (from the factory or your own) into the floppy drive of the analyzer.
2. Press **File**, then **Load**.
3. Press **Type, More**, then select **Corrections**.
4. Press **Directory Select**, highlight drive -A-, then press **Directory Select** again.
5. Use the down arrow to select the file. The factory supplied disk has a file with the OTH extension which places the data in the corrections set "other" location.
6. Press **Load Now** to load the conversion loss values into the correction table of the analyzer.

Viewing Data

1. Press **Amplitude, More, Corrections, Other (ON)** and **Edit** to view the correction values.
2. Use the front-panel knob or up/down arrows to scroll through the list of correction values.

Using the Mixers with the E4407B Spectrum Analyzer (Option AYZ)

The Agilent Technologies E4407B spectrum analyzer contains an extensive menu of functions that help with millimeter measurements. The following examples explain how to connect external mixers to the spectrum analyzer, how to choose the band of interest, how to store and activate conversion-loss factors, and how to use the signal-identification functions.

Set up the equipment

1. Connect the signal source and harmonic mixer to the analyzer, as shown in [Figure 2-2](#).

Figure 2-2 Harmonic Mixer Setup

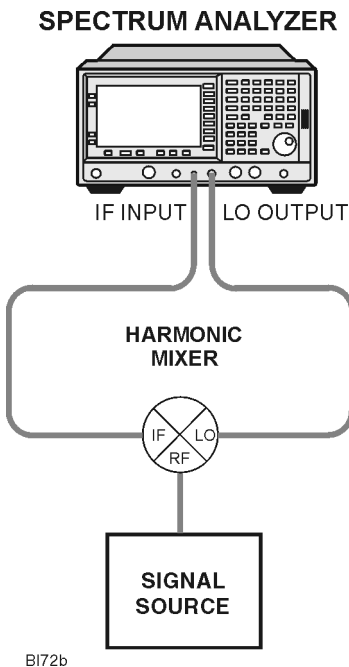

NOTE Agilent 5061-5458 SMA type cables should be used to connect the mixer IF and LO ports to the analyzer. Do not over-tighten the cables. The maximum torque should not exceed 112 N-cm (10 in-lb.)

2. On the analyzer, press **Preset, Factory Preset**, if present.
3. Select external mixing by pressing **Input/Output, Input Mixer, Input Mixer (Ext)**.
4. The analyzer frequency band will be set to **26.5 - 40 GHz (A)**. To choose a different band, press **Ext Mix Band**, then press the desired band frequency range/letter key. For this example, we will use band A, which ranges from 36.5 GHz to 40 GHz.

Amplitude Calibration

The conversion loss versus frequency data can be entered on your analyzer from one of three sources.

- From a *Conversion Loss Data Disk*, supplied with your mixer. See “Using a Conversion-Loss Data Disk with the ESA or PSA Series Analyzers” on page 21 .
- Data from the calibration sheet supplied with your mixer.
- From conversion-loss data located on the mixer body label.

Manually Entering Conversion-Loss Data

1. The analyzer frequency band will be set to **26.5 – 40 GHz (A)**. To choose a different band, press **Ext Mix Band** and then press the desired band frequency range/letter key. For this example, we will use band A, which ranges from 26.5 GHz to 40 GHz.

NOTE To correct for the conversion-loss of the harmonic mixer in use, the analyzer amplitude correction feature is used.

2. Press **AMPLITUDE Y Scale, More, Corrections**. Select a correction set for use with external mixing. The recommended set to use is **Other** although any available set could be used.
3. Press **Edit** to enter the appropriate conversion loss data for the mixer in use. These values are listed on the mixer, or a calibration sheet that is supplied with the mixer.

NOTE More correction points entered across the band in use will improve frequency response accuracy. Up to 200 points may be defined for each set.

4. Once the desired correction points are entered, press **Return, Correction (On)** to activate correction set **Other**. This will also turn corrections on resulting in a calibrated display. It is recommended that the correction set entered be saved on the internal memory or the floppy drive for future reference. See the ESA User's and Programmer's Reference guide for information on saving correction values.

Signal Identification

The IF output of a harmonic mixer will contain a signal at the intermediate frequency of the analyzer whenever the harmonic frequency of the LO and the frequency of the RF differ by the intermediate frequency.

As a result, within a single harmonic band, a single input signal can produce multiple responses on the analyzer display, only one of which is valid (see Figure 2-3.). These responses come in pairs, where members of the valid response pair are separated by 642.8 MHz and either the right-most (for negative harmonics) or left-most (for positive harmonics) member of the pair is the correct response.

Figure 2-3.

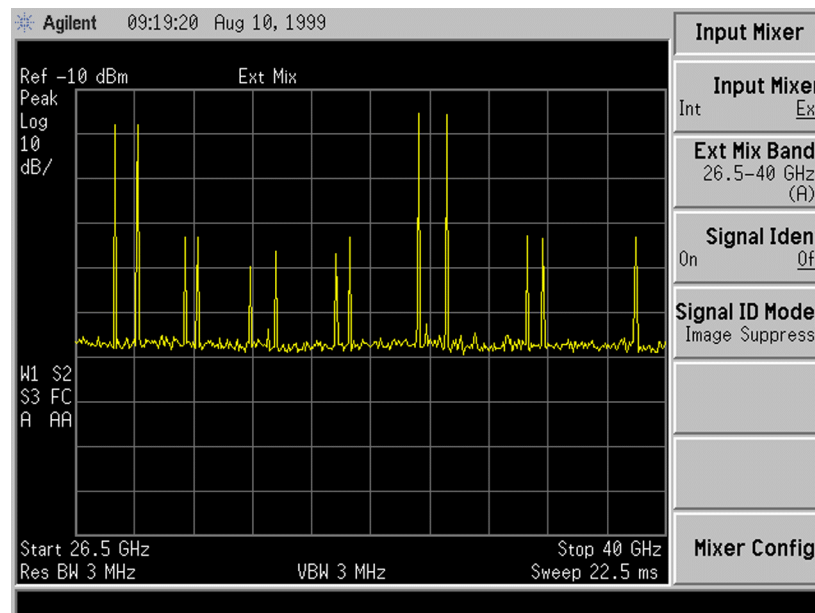

Identification of valid responses is achieved by simply turning on the signal-identification feature. (instrument preset selects the Image Suppress signal identification mode.) Press **Input/Output**, **Input Mixer**, **Signal Ident (On)** and note that now only the valid response (35 GHz) remains.

Press **Peak Search** to place a marker on the remaining response. The signal-identification routine can introduce slight amplitude errors which is indicated by the message Signal Ident On, Amptd Uncal. Refer to Figure 2-4..

After identifying a signal of interest, press **Signal Ident (Off)** before making final amplitude measurements. Note that Image Suppress should only be used to identify the fundamental signal and not for accurate amplitude measurements.

Figure 2-4.

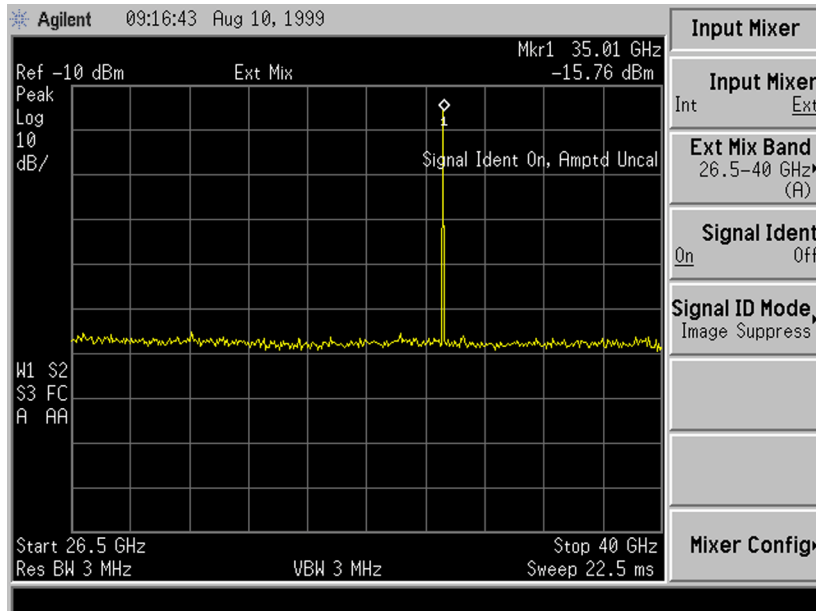

Using the Mixers with the E4440A, E4446A, or E4448A PSA Series Spectrum Analyzer (Option AYZ)

Be sure to refer to “[Spectrum Analyzer Retrofit Requirements](#)” on page 9 for instrument requirements for the PSA Series spectrum analyzers. The Agilent Technologies PSA Series spectrum analyzers contain an extensive menu of functions that help with millimeter measurements. The following examples explain how to connect external mixers to the spectrum analyzer, how to choose the band of interest, how to store and activate conversion-loss factors, and how to use the signal-identification functions.

Set up the equipment

1. Connect the signal source and harmonic mixer to the analyzer, as shown in [Figure 2-2](#).

Figure 2-5 Harmonic Mixer Setup

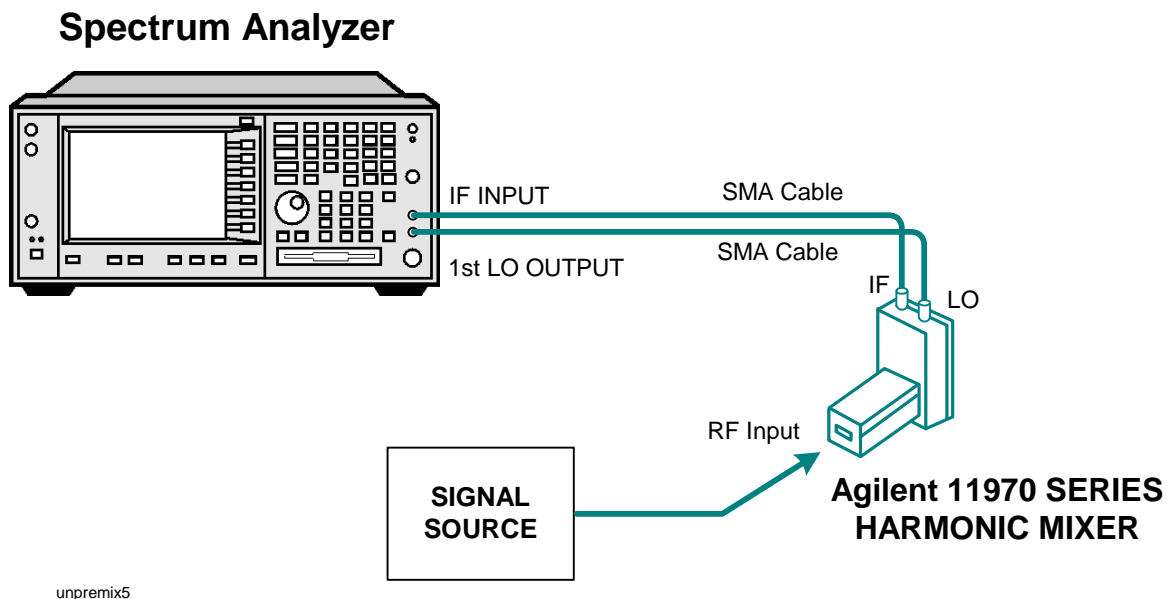

NOTE Agilent 5061-5458 SMA type cables should be used to connect the mixer IF and LO ports to the analyzer. Do not over-tighten the cables. The maximum torque should not exceed 112 N-cm (10 in-lb.)

2. On the analyzer, press **Preset, Factory Preset**, if present.
3. Select external mixing by pressing **Input/Output, Input Mixer, Input Mixer (Ext)**.
4. The analyzer frequency band will be set to **26.5 - 40 GHz (A)**. To choose a different band, press **Ext Mix Band**, then press the desired band frequency range/letter key. For this example, we will use band A, which ranges from 36.5 GHz to 40 GHz.

Amplitude Calibration

The conversion loss versus frequency data can be entered on your analyzer from one of three sources.

- From a *Conversion Loss Data Disk*, supplied with your mixer. See “Using a Conversion-Loss Data Disk with the ESA or PSA Series Analyzers” on page 21 .
- Data from the calibration sheet supplied with your mixer.
- From conversion-loss data located on the mixer body label.

Manually Entering Conversion-Loss Data

1. The analyzer frequency band will be set to **26.5 – 40 GHz (A)**. To choose a different band, press **Ext Mix Band** and then press the desired band frequency range/letter key. For this example, we will use band A, which ranges from 26.5 GHz to 40 GHz.

NOTE To correct for the conversion-loss of the harmonic mixer in use, the analyzer amplitude correction feature is used.

2. Press **AMPLITUDE Y Scale, More, Corrections**. Select a correction set for use with external mixing. The recommended set to use is **Other** although any available set could be used.
3. Press **Edit** to enter the appropriate conversion loss data for the mixer in use. These values are listed on the mixer, or a calibration sheet that is supplied with the mixer.

NOTE More correction points entered across the band in use will improve frequency response accuracy. Up to 200 points may be defined for each set.

4. Once the desired correction points are entered, press **Return, Correction (On)** to activate correction set **Other**. This will also turn corrections on resulting in a calibrated display. It is recommended that the correction set entered be saved on the internal memory or the floppy drive for future reference. See the ESA User's and Programmer's Reference guide for information on saving correction values.

Signal Identification

The IF output of a harmonic mixer will contain a signal at the intermediate frequency of the analyzer whenever the harmonic frequency of the LO and the frequency of the RF differ by the intermediate frequency.

As a result, within a single harmonic band, a single input signal can produce multiple responses on the analyzer display, only one of which is valid (see Figure 2-6.). These responses come in pairs, where members of the valid response pair are separated by 642.8 MHz and either the right-most (for negative harmonics) or left-most (for positive harmonics) member of the pair is the correct response.

Figure 2-6.

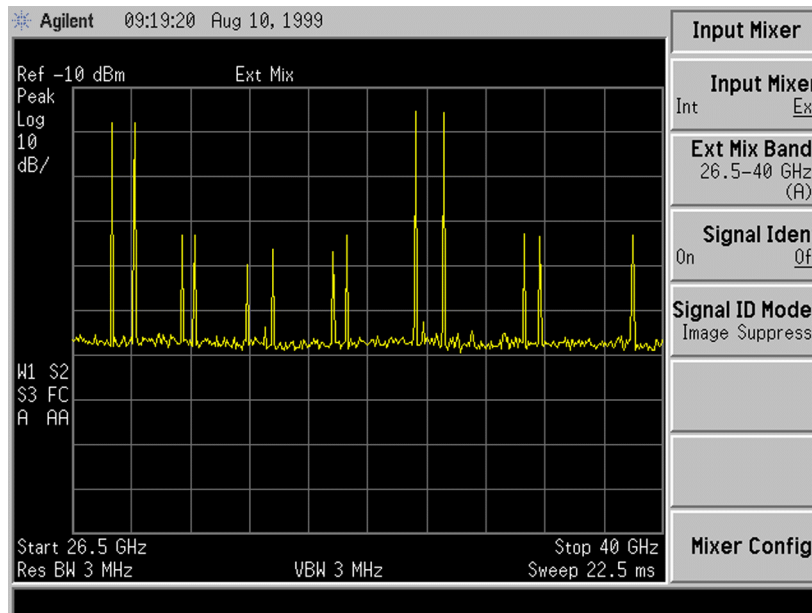

Identification of valid responses is achieved by simply turning on the signal-identification feature. (instrument preset selects the Image Suppress signal identification mode.) Press **Input/Output**, **Input Mixer**, **Signal Ident (On)** and note that now only the valid response (35 GHz) remains.

Press **Peak Search** to place a marker on the remaining response. Refer to Figure 2-7.

After identifying a signal of interest, press **Signal Ident (Off)** before making final amplitude measurements. Note that Image Suppress should only be used to identify the fundamental signal and not for accurate amplitude measurements.

Figure 2-7.

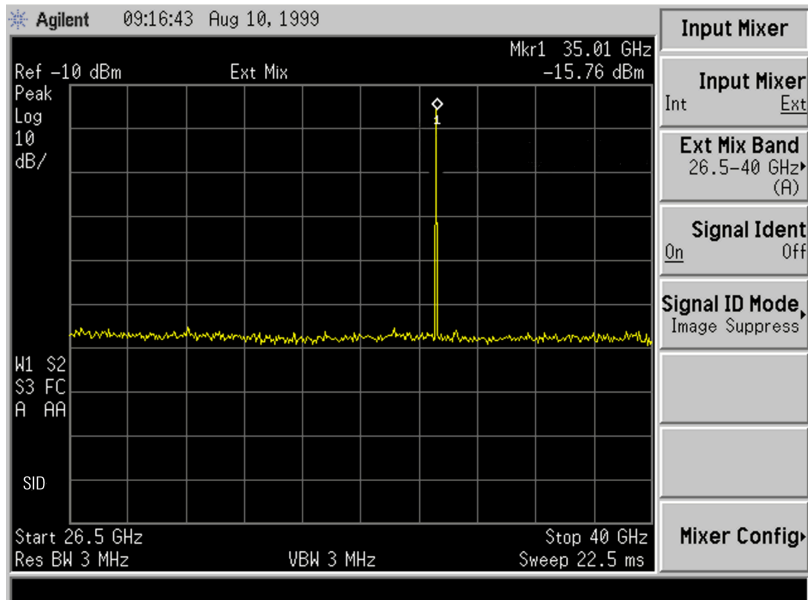

Operation

Using the Mixers with the 856X Series Spectrum Analyzers

External millimeter mixers can be used to extend the frequency coverage of the 8560 E-Series and EC-Series spectrum analyzers. (The 8560E/EC Option 002 and Option 327 do not have external mixing capability.)

The 8560 E-Series and EC-Series spectrum analyzers contain an extensive menu of functions that help with millimeter measurements. This example explains how to connect external mixers to the spectrum analyzer, how to choose the band of interest, how to store conversion-loss factors, and how to use the optional automatic signal-identification functions.

Set up the equipment

1. Figure 2-8 illustrates how to connect an external harmonic mixer to the spectrum analyzer.

Figure 2-8 External Mixer Setup

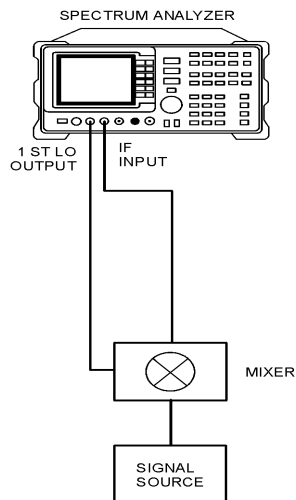

NOTE Good-quality shielded SMA-type cables should be used to connect the mixer to the spectrum analyzer to ensure that no signal attenuation occurs. Agilent 5061-5458 SMA-type cables may be used. Do not over-tighten the cables; the maximum torque should not exceed 112 N-cm (10 in-lb.).

Select the Frequency Band

2. Specify unpreselected external mixing by pressing **CONFIG**, then **EXT MXR PRE UNPR** until **UNPR** is selected.
3. To select a frequency above 18 GHz:
 - a. Press **AUX CTRL**, **EXTERNAL MIXER** to set the analyzer to external mixer mode.
 - b. Enter the desired frequency directly using the center-frequency function.
 - c. Notice in [Table 2-1](#) that some frequencies overlap and fall into two bands. To be sure that the desired band is selected, refer to [Table 2-1](#) and select the desired frequency band, then use the full band function to enter this band.
 - d. In the external mixer menu, press **FULL BAND**, then press the step up \uparrow key until the letter preceding **BAND** in the active function area corresponds to the desired frequency band.

Table 2-1 External Mixer Frequency Ranges

Frequency Band	Frequency Range (GHz)	Mixing Harmonic	Conversion Loss
K	18.0 to 26.5	6-	30 dB
A	26.5 to 40.0	8-	30 dB
Q	33.0 to 50.0	10-	30 dB
U	40.0 to 60.0	10-	30 dB
V	50.0 to 75.0	14-	30 dB
E	60.0 to 90.0	16-	30 dB
W	75.0 to 110.0	18-	30 dB
F	90.0 to 140.0	24-	30 dB
D	110.0 to 170.0	30-	30 dB
G	140.0 to 220.0	36-	30 dB
Y	170.0 to 260.0	44-	30 dB
J	220.0 to 325.0	54-	30 dB

In this example, we'll look at U-band, which ranges from 40 GHz to 60 GHz, as shown in Figure 2-9. The **LOCK HARMONIC** function "locks" the spectrum analyzer in that band, ensuring that the spectrum analyzer sweeps only the chosen band. **LOCK ON OFF** is automatically set to ON when **FULL BAND** is pressed.

Figure 2-9 Select the band of interest.

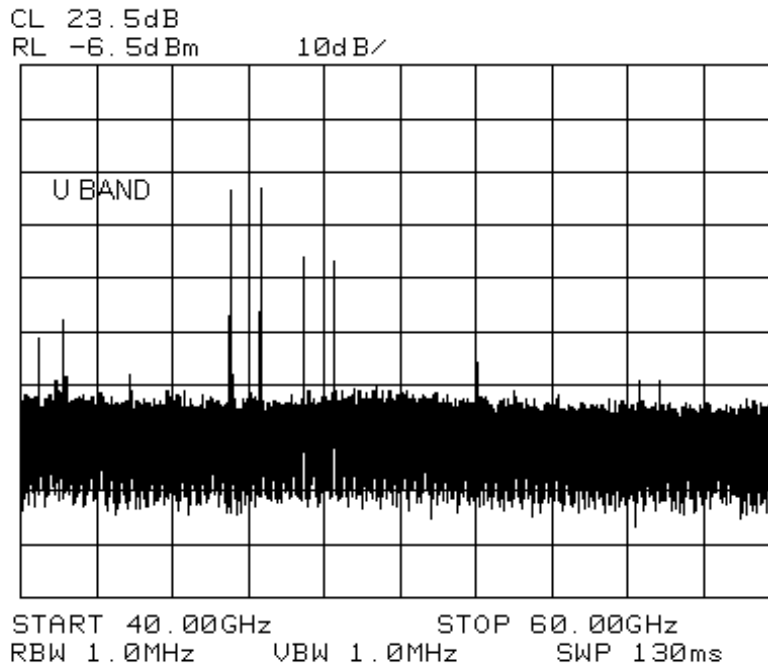

Save the average conversion-loss value

4. Default conversion-loss values that are stored in the analyzer for each frequency band are listed in Table 2-1. These values approximate the values for the Agilent 11970 series mixers. Other conversion-loss values may be entered into the spectrum analyzer in two ways. The first method lets you to save the average conversion-loss value for the entire band using **AVERAGE CNV LOSS**. To activate this function:
 - a. Press **AUX CTRL**, **EXTERNAL MIXER**, **AMPTD CORRECT**, **AVERAGE CNV LOSS**.
 - b. Enter the appropriate average conversion-loss value. On Agilent 11970 Series harmonic mixers, these values are printed on the mixer. The U-band mixer used for this example had an average conversion loss of 23.5 dB, as shown in Figure 2-10.

Figure 2-10 Store and correct for conversion loss.

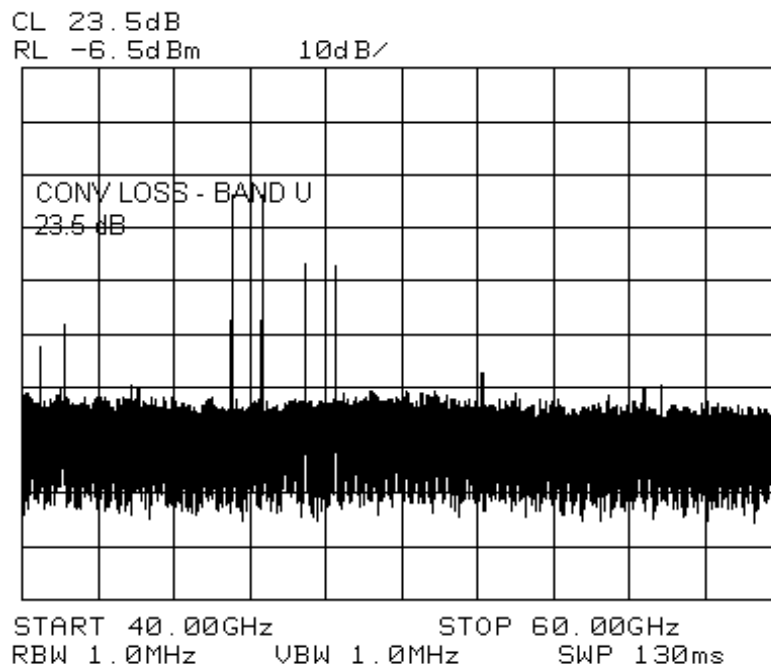

The second method for storing conversion-loss information lets you save individual conversion-loss data points at specific intervals across the harmonic band, using **CNV LOSS VS FREQ.**

To view or enter a conversion-loss data point:

- a. Press **CNV LOSS VS FREQ.**
- b. Enter the conversion-loss data at the frequency shown.
- c. Use the step up \uparrow key to step through the band, entering the conversion loss at each step.

Signal Identification

5. The IF output of a harmonic mixer contains many mixer products (frequencies of $LO \pm$ source, $2LO \pm$ source, $3LO \pm$ source... $nLO \pm$ source). As a result, within a single harmonic band, a single input signal can produce many responses, only one of which is valid.

These responses come in pairs, where the members of the valid pair are spaced 621.4 MHz apart (see [Figure 2-11](#)) and the right-most member for the pair is the correct response (for this analyzer, the left member of a pair is not valid).

Figure 2-11 Signal Responses Produced by a 50 GHz Signal in U Band

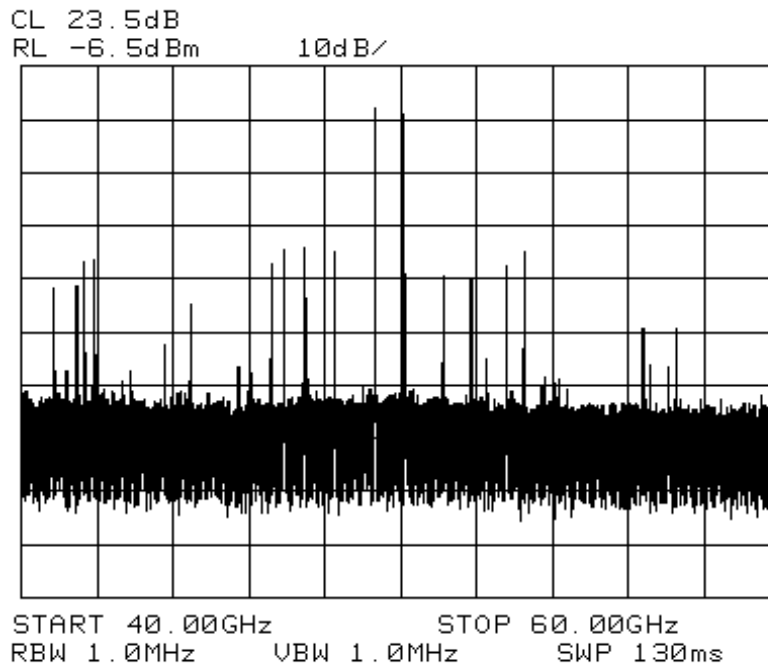

Identify signals with the frequency-shift method

6. Signal-identification routines that identify the signal and images are available on instruments with firmware revisions ≤ 920528 , or with Option 008. The frequency-shift method of identifying valid signals uses the spectrum-analyzer function **SIG ID ON OFF**. When using this function, smaller spans will yield more accurate measurements.

- a. Span down to 50 MHz.
- b. Press **AUX CTRL**, **EXTERNAL MIXER**, **SIGNAL IDENT**.
- c. Press **SIG ID ON OFF** until **ON** is selected.

Any signal not produced by the currently selected harmonic will be shifted horizontally on alternate sweeps (see Figure 2-12). Therefore, when viewing the display, on alternate sweeps the signal will appear, then not appear, at the frequency of interest. The correct signal produced by the selected harmonic will be shifted in a vertical direction only, as shown in Figure 2-13.

Figure 2-12 Response for Invalid Signals

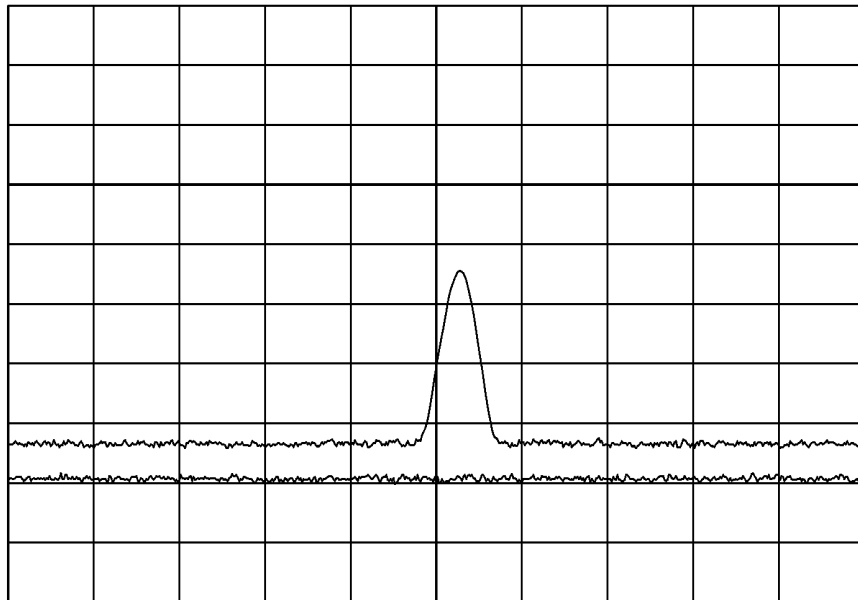
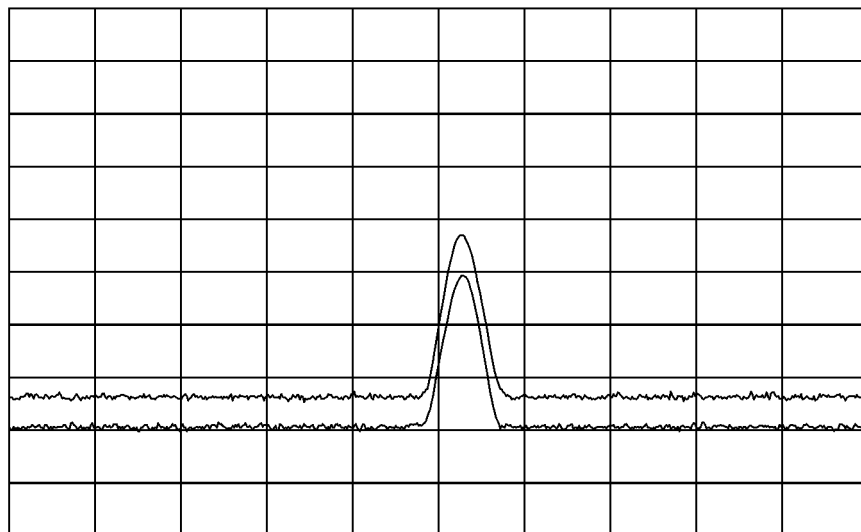

Figure 2-13 Response for Valid Signals



Operation

Identify signals in wide frequency spans

7. **SIG ID AT MKR** identifies signals in wide frequency spans, using harmonic search. **SIG ID AT MKR** automatically determines the proper frequency of a signal and displays its value on the spectrum analyzer.
 - Activating **SIG ID AT MKR** on an image of the signal will yield a reading in the active block, as shown in [Figure 2-14](#). The true signal frequency is given with an identifier that the marker resides on an image. If the marker is placed on a true signal, and **SIG ID AT MKR** is activated, the signal frequency will appear without the **IMAGE** notation, as shown in [Figure 2-15](#).
8. To activate **SIG ID AT MKR**:
 - a. Place a marker on a signal.
 - b. Press **AUX CTRL**, **EXTERNAL MIXER**, **SIGNAL IDENT**, **SIG ID AT MKR**.
9. To exit the external mixer mode, press **AUX CTRL**, then **INTERNAL MIXER**.

Figure 2-14 SIG ID AT MKR Performed on an Image Signal

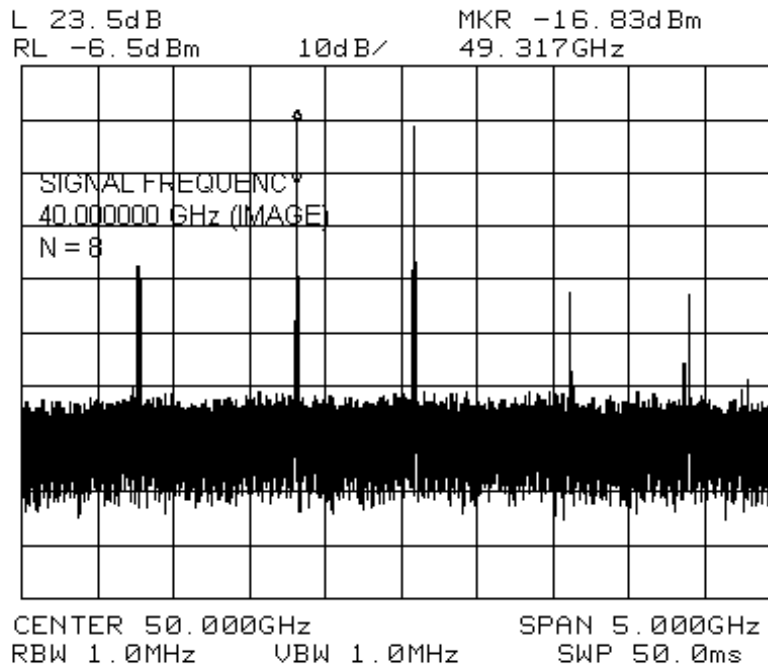
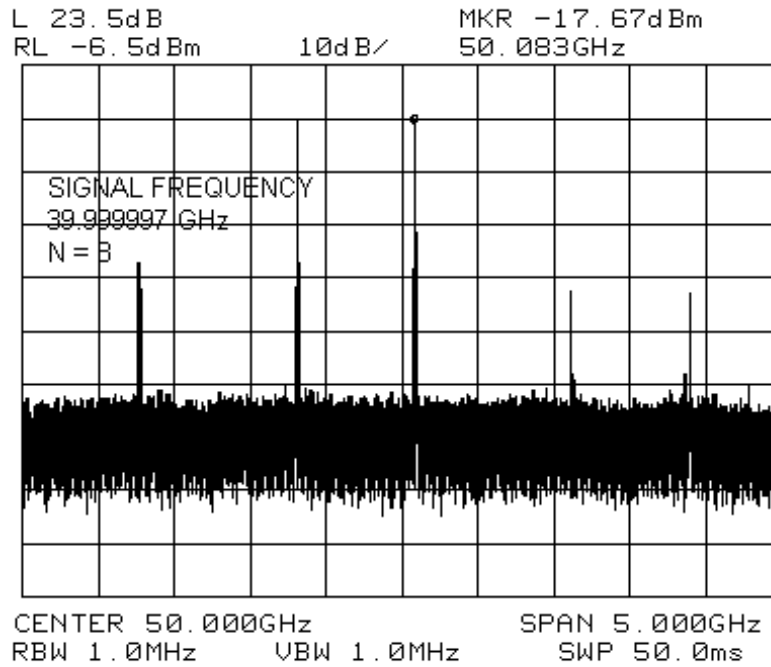

Figure 2-15 SIG ID AT MKR Performed on a True Signal



Using the Mixers with MMS Analyzers

Preliminary Operation

NOTE This section provides information for the Agilent 70907A (or B), however the operation of the Agilent 70909A and Agilent 70910A is similar. Minor differences may be noted, but the necessary deviations from these exact instructions will be obvious.

Equipment Connection

Connect the equipment as shown in [Figure 2-16](#) Use the following checklist to verify the connections:

- Agilent 11970 LO IN to Agilent 70907B LO OUTPUT (SMA cable, 5061-5458)
- Agilent 11970 IF OUT to Agilent 70907B IF INPUT (SMA cable, 5061-5458)

Figure 2-16 Agilent 11970 Connections to the Agilent 71000 Series Spectrum Analyzer

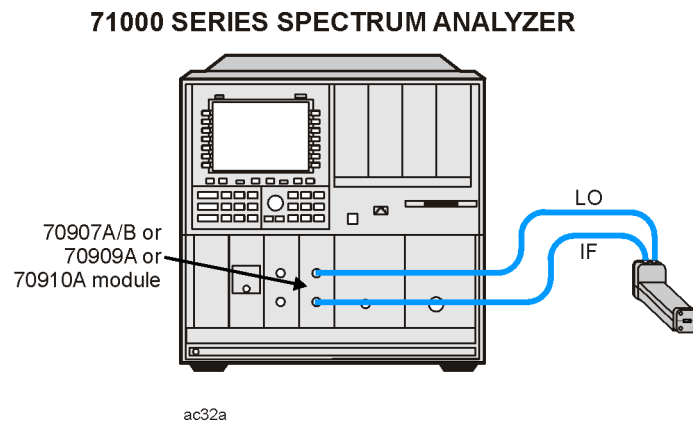

Operation

Band Selection

Use the following key sequence to enter the external mixing mode and to select the desired band of operation:

MENU

Select Input - choose external mixer input, for example: "IN 2 EM 70910A"

State

ext mixer

fulband KAQUVE

Press the softkey for the desired band.

NOTE The above band selection key sequence *must* be used to enter the external mixing band of operation. Do not enter in the center frequency of the band directly.

Amplitude Calibration for a Single Frequency

Enter the conversion loss at the desired frequency from either the calibration label on the end of the Agilent 11970 or the supplied calibration sheet by using the following key sequence:

State

ext mixer

CONV LOSS

Enter the conversion loss value of the desired frequency, then terminate the entry with **dB**.

NOTE The above procedure is a single-point conversion-loss correction. For an alternative procedure, available by remote programming only, refer to ["Conversion Loss Versus Frequency Correction"](#) on page 43.

General Descriptions of Agilent 71000 Series Spectrum Analyzer External-Mixing Functions

ext mixer Allows access to the following softkey functions that control the measurement range when an external mixer extends the spectrum analyzer frequency range. The **ext mixer** softkey can be found under the **State** key.

fulband KAQUVE
fulband WFDGYJ
CONV LOSS
SIGNAL IDENT

fulband KAQUVE
and
fulband WFDGYJ

Specify the frequency range for measurements made with external mixers. Twelve frequency bands are available. [Table 2-2](#) lists the start and stop frequencies of each band and also shows which local-oscillator harmonic (N) is used for the mixing process. Once a band is selected, the frequency range is locked and the spectrum analyzer tunes with the local-oscillator harmonic for that band only.

Table 2-2 External Mixing Bands and Associated Mixing Harmonics

Band	Harmonic Number (N)	Frequency Range (GHz)
K	6–	18.0 to 26.5
A	8+	26.5 to 40.0
Q	10+	33.0 to 50.0
U	10+	40.0 to 60.0
V	14+	50.0 to 75.0
E	16+	60.0 to 90.0
W	18+	75.0 to 110.0
F	24+	90.0 to 140.0
D	30+	110.0 to 170.0
G	36+	140.0 to 220.0
Y	42+	170.0 to 260.0
J	50+	220.0 to 330.0

CONV LOSS
(conversion loss)

Offsets the reference level to compensate for amplitude losses at the active input port. If necessary, use **select input** to activate the desired input port before specifying its conversion-loss offset.

To clear the offset, enter a conversion loss of zero.

After the instrument preset, a default value of 30 dB is activated automatically for the input port of the external-mixer-interface module.

Preset Input

Sets which active input port will be selected when the **INSTR PRESET** is pressed. The preset input softkey can be accessed by pressing **State**, then **MORE**.

INSTR PRESET

Resets to the preset input and to the lowest full frequency range available. (For an external mixer, this is band A.) This is a front panel key.

SIGNAL IDENT
(signal identify)

Press **Frequency**, **More**, **sig id options**.

Executes a routine to identify real, in-band signals using either the image (default) or shift methods.

Several options are available under **sig id options**:

- **SIG ID ⇒ CF** Places the marker on the identified real signal and centers the signal on the display.
- **SIG ID MAN OFF** Selects manual or automatic (default) mode.
- **IMAGE/SHIFT** Selects the routine to use for identification.
- **SIG ID AMPTD Δ** Specifies the amplitude difference between the marked signal and signals tested as images or harmonics (default is 10 dB; applies only to IMAGE mode.)
- **IMAGE N START** Determines the frequency range for possible image or harmonic responses by selecting the lowest and highest local oscillator harmonic used for mixing, according to the tuning equation below:

$$F_s = N \times F_{LO} \pm IF$$

Default is 1.
- **IMAGE N STOP** See “**IMAGE N START**” definition above.
Default is 40.

NOTE See the table below for available frequency ranges and related harmonic numbers. Use the **IMAGE N START** and **IMAGE N STOP** softkeys for the image identification only.

Table 2-3 Frequency Ranges and Corresponding Harmonic Numbers

	Band/Range	Harmonic Number and Sign of IF (N)
Internal Mixing - Agilent 71210C	2.9 - 6.2	-1
	6.0 - 12.7	-2
	12.5 - 19.9	+3
	19.7 - 22.0/26.5	+4
Internal Mixing - Agilent 71200C	2.9 - 6.2	-1
	6.0 - 12.8	-2
	12.6 - 22.0	-4
External Mixing - Agilent 70907A 7090 7B 709 10A 709 09A	K 18.0 - 26.5	+6
	A 26.5 - 40.0	+8
	Q 33.0 - 50.0	+10
	U 40.0 - 60.0	+10
	V 50.0 - 75.0	+14
	E 60.0 - 90.0	+16
	W 75.0 - 110.0	+18
	F 90.0 - 140.0	+24
	D 110.0 - 170.0	+30
	G 140.0 - 220.0	+36
	Y 170.0 - 260.0	+42
J 220.0 - 330.0	+50	

Conversion Loss Versus Frequency Correction

The Agilent 71000 Series Spectrum Analyzers with the Agilent 70907A (or B) External Mixer Interface Module installed has the amplitude-correction function (AMPCOR) available by remote programming.

Use AMPCOR to compensate for the Agilent 11970 Series frequency-dependent conversion-loss variations. Up to 200 pairs of frequency-amplitude correction points can be entered, depending on the amount of available internal memory. The frequency values entered must be in increasing order, or an error condition results. Whenever AMPCOR is on, the correction values are added to all measurement results.

The values of the correction points are applied across the active measurement range. Between points, the correction value are interpolated. When the measuring at frequencies outside of the first and last correction pairs from memory.

When AMPCOR is executed, the frequency pairs are stored in internal memory. The remote commands `DISPOSE ALL`, `FORMAT`, `ERASE`, and `DISPOSE AMP COR` erase the amplitude-correction pairs from memory.

NOTE `DISPOSE ALL`, `FORMAT`, and `ERASE` erases much more than the amplitude-correction pairs from memory. Do not use these commands without referring to the programmer's manual for the Agilent 70000 and Agilent 70900B to determine their effect on instrument programming.

Because AMPCOR adjusts IF gain and attenuation, AMPCOR should be used with care when measuring signals near the compression level (also at a frequency that is corrected by the AMPCOR command).

To use AMPCOR for the Agilent 11970 conversion loss correction, first set the single-point conversion loss function to zero with the following command:

```
OUTPUT 718; "CNVLOSS 0DB;"
```

Then build the AMPCOR table with frequency conversion loss pairs. The following example program line shows three pairs of frequency conversion loss values for a typical Agilent 11970V.

```
OUTPUT 718; "AMPCOR 50GHZ, 49.6DB, 51GHZ, 49.1DB, 52GHZ, 48.6DB;"
```

The conversion loss corrections are activated by the AMPCOR ON command; use AMPCOR OFF to deactivate the function (be sure to manually enter a single-point conversion-loss value if AMPCOR has been used).

To print out an existing AMPCOR table, use the program listed below:

```
10 dim A$ (1:20) [30]
20 OUTPUT 718; "CONVLOSS 0DB;"
30 OUTPUT 718; "AMPCOR 50 GHZ, 46.1DB, 52GHZ, 46.7DB, 53GHZ,47.2DB;"
40 !
50 OUTPUT 718; "AMPCOR?;"
60 ENTER 718 USING "%,k";A$ (*)
70 !
80 FOR I=1 TO 10
90 PRINT "Point ";I,A$ (I)
100 NEXT I
110 END
```

Line 30: Generates an AMPCOR table.

Line 60: % specifies that an EOI terminates the entire statement. "K" specifies that an
LF terminates the individual string entry.

Returned values are in the format where the frequency in Hz is listed first, followed by the conversion loss in dB. See the following example:

```
Point 1 50.00000000E+9,46.1
Point 2 52.00000000E+9,46.7
Point 3 53.00000000E+9,47.2
Point 4
Point 5
Point 6
Point 7
Point 8
Point 9
Point 10
Point 11
```

NOTE For further information, consult the Agilent 70900B
Local-Oscillator-Controlled Modules Programming Manual, part number
70900-90284.

Using the Mixers with the 8566B Spectrum Analyzer

Set up the equipment

1. Connect the external harmonic mixer to the spectrum analyzer, as shown in [Figure 2-17](#).

NOTE Good-quality shielded SMA-type cables should be used to connect the mixer to the spectrum analyzer to ensure that no signal attenuation occurs. Agilent 5061-5458 SMA-type cables may be used. Do not over-tighten the cables; the maximum torque should not exceed 112 N-cm (10 in-lb.).

Figure 2-17 External Mixer Connection

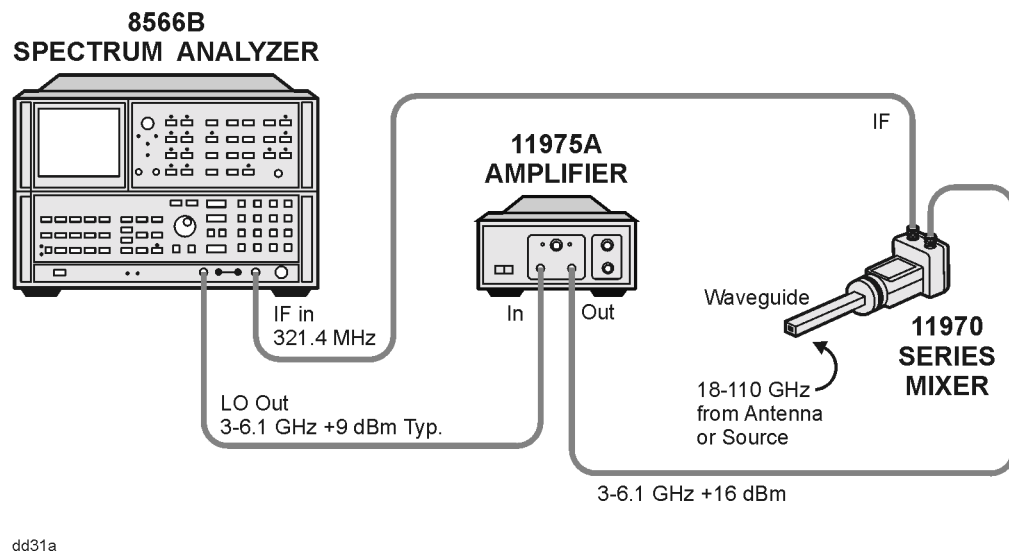

CAUTION Before connecting the Agilent 11975A Amplifier, set the ALC switch to ON. Failure to do so can damage the mixer.

2. Power up the spectrum analyzer and then the amplifier.
3. Adjust the amplifier power to 16 dBm.
4. To access the spectrum analyzer's millimeter bands, press **SHIFT** and then the up arrow \uparrow until the desired band is displayed on the screen, as shown in [Figure 2-18](#). Note that this is important because toggling through the bands, causes the band to automatically harmonic lock as evidenced by the on-screen annotation of "Harmonic 6" changing to

"Harmonic 6L", where "L" stands for locked, or you could press **Shift+z** to manually harmonic lock.

Figure 2-18 TYPICAL MILLIMETER SIGNAL DISPLAY

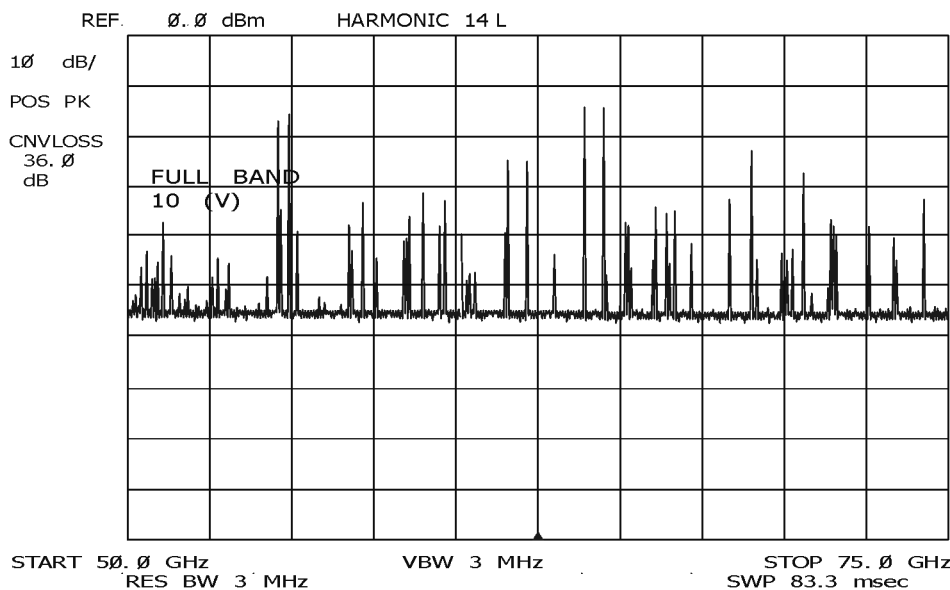

dd32a

A menu of millimeter measurement functions is accessed by pressing **SHIFT, 1, MHz**. Even though the spectrum analyzer is in an external mixer band, the 8566B spectrum analyzer retains full operation capability (except for use of the RF input attenuator and preselector).

Amplitude Calibration

Procedure

Each 11970 series harmonic mixer is characterized at the factory and comes with a calibration chart (See [Figure 2-19](#)). The horizontal axis of the chart gives the frequency range of the mixer and the two vertical axis scales are calibrated in conversion loss and in reference level offset.

To correct the amplitude calibration of the spectrum analyzer to account for the conversion loss of the harmonic mixer, press **SHIFT, 1, MHz**, which accesses the millimeter menu. Then press **SHIFT, 5, MHz** to access conversion loss entry and key in the appropriate value on the spectrum analyzer as shown on the mixer calibration chart.

For measurements that span the entire band, choose an average value of conversion loss from the conversion loss chart. For those spectrum analyzers with date codes earlier than 13.8.86, the conversion loss is changed using the reference level function. Press **SHIFT**, then **REFERENCE LEVEL**, then key in the reference level offset shown on the right side of the mixer calibration chart.

Signal Identification

Figure 2-18 shows a typical full-band display of a single input signal. Direct interpretation of the display is difficult because of the large number of responses produced by several local oscillator harmonics generated in the mixer. To solve this problem the 8566B spectrum analyzer uses two methods of signal identification.

The first is an automatic image search in which the spectrum analyzer looks for a signal image within a preset range of harmonic numbers. This automatic signal identification routine is initiated by pressing **SHIFT, 3, MHz**. Upon completion, one of three messages appears on the CRT: **SIGNAL NOT IDENTIFIED**, **SIGNAL IDENTIFIED OUT OF BAND** (with the frequency), or **CENTER** (with the identified signal frequency). The range of harmonic numbers through which the spectrum analyzer searches can be changed by accessing "search start HN" and "search stop HN," which are **SHIFT, 7, MHz** and **SHIFT, 8, MHz**, respectively.

The second method, manual signal identification, is a fast method of verifying that the displayed signal is a true signal in the specified band. Press **SHIFT, 4, MHz** to activate this function. Positive signal identification is indicated if the signal in question does not change frequency and is reduced in amplitude by one to two divisions on alternate sweeps. A failed signal identification is indicated by the signal disappearing or shifting in frequency.

Figure 2-19 Sample Mixer Calibration Table

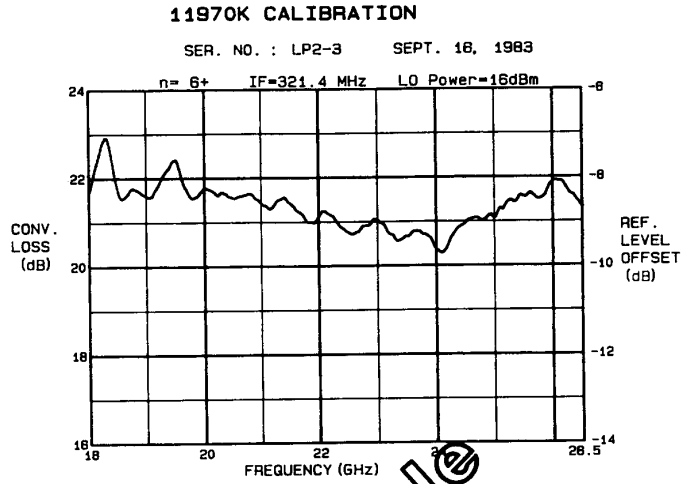

FREQ.	CONV. LOSS	REF. LVL OFS.	FREQ.	CONV. LOSS	REF. LVL OFS.
18.00	21.7	-8.3	22.25	21.1	-8.9
18.25	22.8	-7.7	22.50	20.7	-9.3
18.50	21.7	-8.3	22.75	20.9	-9.1
18.75	21.8	-8.2	23.00	21.0	-9.0
19.00	21.6	-8.4	23.25	20.7	-9.3
19.25	22.0	-8.0	23.50	20.7	-9.3
19.50	22.4	-7.6	23.75	20.7	-9.3
19.75	21.6	-8.4	24.00	20.4	-9.6
20.00	21.8	-8.2	24.25	20.6	-9.4
20.25	21.6	-8.4	24.50	21.0	-9.0
20.50	21.5	-8.5	24.75	21.0	-9.0
20.75	21.6	-8.4	25.00	21.1	-8.9
21.00	21.4	-8.6	25.25	21.5	-8.5
21.25	21.4	-8.6	25.50	21.5	-8.5
21.50	21.4	-8.8	25.75	21.5	-8.5
21.75	21.1	-8.9	26.00	21.9	-8.1
22.00	21.1	-8.9	26.25	21.7	-8.3
			26.50	21.3	-8.7

3 Performance Tests

Introduction

This section contains instructions for testing the performance of the 11970 Series Mixers. Performance tests are used to check the mixers at incoming inspection and for periodic evaluation. The tests verify the specifications listed for the mixers in [Table 1-1](#).

Test equipment required for the performance tests is listed in [Table 3-1](#). for the 11970K, [Table 3-2](#). for the 11970A, [Table 3-3](#). for the 11970Q, [Table 3-4](#). for the 11970U, [Table 3-5](#). for the 11970V and [Table 3-6](#). for the 11970W. Test instruments other than those listed may be used provided their performance equals or exceeds the critical specifications listed in [Tables 3-1](#) through [3-6](#).

Test Record

At the end of each test is a test record, which is used for recording the performance test data. Make copies of these test records and use them as worksheets when doing the tests.

Performance Test Procedures

Description

Each performance test procedure is contained in a single paragraph. The first entry in each paragraph is the specification for the parameter being measured as described in [Table 1-1](#). This is followed by a general description of the test and any special instructions or problem areas. Appropriate test setup illustrations are included in this section and are referenced in the procedures. You **MUST** do the tests, and the steps within each test, in the order they are given.

Table 3-1. Recommended Test Equipment for 11907K

Instrument	Critical Specifications	Recommended Model
Spectrum Analyzer	LO and IF ranges compatible with mixer	8566B
Synthesized Sweeper	Frequency: 18 to 26.5 GHz Output Level: >-10 dBm	8340A
Amplifier	Output Level: >18 dBm leveled Frequency Range: 3 to 4.5 GHz	11975A
Power Meter	Compatible with Power Sensor	436A
Power Sensor	SWR: <1.3	8485A
Directional Coupler ¹	Coupling: 10 dB Directivity: >40 dB Primary Arm SWR: <1.05 Auxiliary Arm SWR: <1.2	K752C
Isolator	Insertion Loss: <1.5 dB Isolation: >20 dB SWR: <1.2	P/N 0960-0081
Adapter (2 required)	3.5 mm female to WR-42 SWR: <1.1	K281C
Cables (3 required)	Connectors: SMA male	P/N 5061-5458
Cable	Connectors: SMA Loss: <1.0 dB @ 20 GHz	P/N 8120-4396

1. Calibration data for the coupling ratio between the output arm and the auxiliary arm is necessary for accurate measurements.

Table 3-2. Recommended Test Equipment for 11970A

Instrument	Critical Specifications	Recommended Model
Spectrum Analyzer	LO and IF ranges compatible with mixer	8566B
Synthesized Sweeper	Frequency: 8 to 13.5 GHz Output Level: >0 dBm	8340A
Amplifier	Output Level: >18 dBm leveled Frequency Range: 3 to 5 GHz	11975A
Amplifier	Frequency Range: 8 to 13.5 GHz Output Level >15 dBm	8349A
Power Meter	Compatible with Power Sensor	436A
Power Sensor	SWR: <2.0	R8486A
Power Sensor	SWR: <1.3 @ 6 GHz	8485A
Directional Coupler ¹	Coupling: 20 dB Directivity: >40 dB Primary Arm SWR: <1.05 Auxiliary Arm SWR: <1.2	R752D
Isolator	Insertion Loss: <1.5 dB Isolation: >20 dB SWR: <1.2	P/N 0960-0082
Frequency Tripler	Input Power: >10 dBm minimum Conversion Loss: <15 dB	Spacekom Microwave ² TKa-1
Adapter	SMA female to SMA female	P/N 1250-1158
Adapter	SMA female to Type N female	P/N 1250-1404
Adapter (2 required)	Type N male to SMA female	P/N 1250-1250
Cables (3 required)	Connectors: SMA male	P/N 5061-5458
Cable	Connectors: SMA male Loss: <1.0 dB @ 20 GHz	P/N 8120-4396
Cable	Connectors: BNC male	11086A

1. Calibration data for the coupling ration between the output arm and the auxiliary arm is necessary for accurate measurements.
2. Honeywell, Inc. Spacekom Microwave Center, Santa Barbara, CA

Table 3-3. Recommended Test Equipment for 11970Q

Instrument	Critical Specifications	Recommended Model
Spectrum Analyzer	LO and IF ranges compatible with mixer	8566B
Synthesized Sweeper	Frequency: 11.0 to 16.7 GHz Output Level: >0 dBm	8340A
Amplifier	Output Level: >18 dBm leveled Frequency Range: 4 to 6 GHz	11975A
Amplifier	Frequency Range: 11.0 to 16.7 GHz Output Level >15 dBm	8349A
Power Meter	Compatible with Power Sensor	436A
Power Sensor	SWR: <2.0	Q8486A
Power Sensor	SWR: <1.3 @ 6 GHz	8485A
Directional Coupler ¹	Coupling: 20 dB Directivity: >30 dB Auxiliary Arm SWR: <1.2	Q752D
Isolator	Insertion Loss: <2 dB Isolation: >20 dB SWR: <1.5	Q365A
Frequency Tripler	Conversion Loss: <20 dB	Spacekom Microwave ² TKa-1
Adapter	SMA female to Type N female	P/N 1250-1404
Adapter	SMA female to SMA female	P/N 1250-1158
Adapter (2 required)	Type N male to SMA female	P/N 1250-1250
Cables (4 required)	Connectors: SMA male	P/N 5061-5458
Cable	Connectors: SMA male Loss: <1.0 dB @ 20 GHz	P/N 8120-4396
Cable	Connectors: BNC male	11086A

1. Calibration data for the coupling ration between the output arm and the auxiliary arm is necessary for accurate measurements.
2. Honeywell, Inc. Spacekom Microwave Center, Santa Barbara, CA

Table 3-4. Recommended Test Equipment for 11970U

Instrument	Critical Specifications	Recommended Model
Spectrum Analyzer	LO and IF ranges compatible with mixer	8566B
Synthesized Sweeper	Frequency: 13.3 to 20 GHz Output Level: > 9 dBm	8340A
Amplifier	Output Level: > 18 dBm leveled Frequency Range: 4 to 6 GHz	11975A
Amplifier	Frequency Range: 13.3 to 20 GHz Output Level >15 dBm	8349A
Power Meter	Compatible with Power Sensor	432A
Thermistor Mount	SWR: <2.0	Hughes ¹ 45773H-1100
Thermistor Mount	SWR: <1.3 @ 6 GHz	478A
Directional Coupler ²	Coupling: 20 dB Directivity: >30 dB Auxiliary Arm SWR: <1.2	U752D
Isolator	Insertion Loss: <2 dB Isolation: >20 dB SWR: <1.5	U365A
Frequency Tripler	Conversion Loss: <20 dB	Spacekom Microwave ³ TKa-1
Adapter	SMA female to Type N female	P/N 1250-1404
Adapter	SMA female to SMA female	P/N 1250-1158
Adapter (2 required)	Type N male to SMA female	P/N 1250-1250
Cables (4 required)	Connectors: SMA male	P/N 5061-5458
Cable	Connectors: SMA male Loss: <1.0 dB @ 20 GHz	P/N 8120-4396
Cable	Connectors: BNC male	11086A

1. Hughes Aircraft Co. Electron Dynamics Division, Torrance, CA
2. Calibration data for the coupling ration between the output arm and the auxiliary arm is necessary for accurate measurements.
3. Honeywell, Inc. Spacekom Microwave Center, Santa Barbara, CA

Table 3-5. Recommended Test Equipment for 11970V

Instrument	Critical Specifications	Recommended Model
Spectrum Analyzer	LO and IF ranges compatible with mixer	8566B
Swept Source	Compatible with V-Band Plug-In	8350B
V-Band Source Plug-In	Frequency Range: 50 to 75 GHz Output Level: >0 dBm	Hughes ¹ 47724H-1510
Amplifier	Output Level >18 dBm leveled Frequency Range: 4 to 6 GHz	11975A
Power Meter	Compatible with Power Sensor	432A
Thermistor Mount	SWR: <2.0	Hughes 45774H-1100
Thermistor Mount	SWR: <1.3 @ 6 GHz	478A
Directional Coupler ²	Coupling: 20 dB Directivity: >20 dB Auxiliary Arm SWR: <1.5	Hughes 45324H-1220
Variable Attenuator	Range: 0 to 15 dB	TRG ³ 510V/385
Adapter	SMA female to Type N female	P/N 1250-1404
Adapter	SMA female to SMA female	P/N 1250-1158
Adapter (2 required)	Type N male to SMA female	P/N 1250-1250
Cables (4 required)	Connectors: SMA male	P/N 5061-5458
Cable	Connectors: SMA male Loss: <1.0 dB @ 20 GHz	P/N 8120-4396
Cable	Connectors: BNC male	11086A

1. Hughes Aircraft Co. Electron Dynamics Division, Torrance, CA
2. Calibration data for the coupling ration between the output arm and the auxiliary arm is necessary for accurate measurements.
3. Alpha Industries Inc. TRG Division, Woburn, MA

Table 3-6. Recommended Test Equipment for 11970W

Instrument	Critical Specifications	Recommended Model
Spectrum Analyzer	LO and IF ranges compatible with mixer	8566B
Swept Source	Compatible with W-Band Plug-In	8350B
W-Band Source Plug-In	Frequency Range: 75 to 110 GHz Output Level: >0 dBm	Hughes ¹ 47726H-1510
Amplifier	Output Level >18 dBm leveled Frequency Range: 4 to 6 GHz	11975A
Power Meter	Compatible with Power Sensor	432A
Thermistor Mount	SWR: <2.0	Hughes 45776H-1100
Thermistor Mount	SWR: <1.3 @ 6 GHz	478A
Directional Coupler ²	Coupling: 20 dB Directivity: >20 dB Auxiliary Arm SWR: <1.5	Hughes 45326H-1220
Variable Attenuator	Range: 0 to 15 dB	TRG ³ W510
Adapter	SMA female to Type N female	P/N 1250-1404
Adapter	SMA female to SMA female	P/N 1250-1158
Adapter (2 required)	Type N male to SMA female	P/N 1250-1250
Cables (4 required)	Connectors: SMA male	P/N 5061-5458
Cable	Connectors: SMA male Loss: <1.0 dB @ 20 GHz	P/N 8120-4396
Cable	Connectors: BNC male	11086A

1. Hughes Aircraft Co. Electron Dynamics Division, Torrance, CA
2. Calibration data for the coupling ration between the output arm and the auxiliary arm is necessary for accurate measurements.
3. Alpha Industries Inc. TRG Division, Woburn, MA

Conversion Loss and Frequency Response

Specifications

Conversion Loss:

For a CW RF input power of less than -20 dBm

11970K: 24 dB maximum

11970A: 26 dB maximum

11970Q: 28 dB maximum

11970U: 28 dB maximum

11970V: 40 dB maximum

11970W: 47 dB maximum

Frequency Response:

For an LO amplitude between 14.5 and 16.0 dBm

11970K: ± 1.9 dB

11970A: ± 1.9 dB

11970Q: ± 1.9 dB

11970U: ± 1.9 dB

11970V: ± 2.1 dB

11970W: ± 3.0 dB

For an LO amplitude between 14.0 and 18.0 dBm

11970K: ± 2.8 dB

11970A: ± 2.8 dB

11970Q: ± 2.8 dB

11970U: ± 2.8 dB

11970V: ± 2.8 dB

11970W: ± 4.0 dB

Description

The frequency response and conversion loss are checked at four LO power levels. A known input power is applied to the input of the mixer. The IF output power is measured on the 8566B Spectrum Analyzer. From these measurements, the conversion loss and frequency response are calculated.

1. Connect an SMA cable from the 1st LO OUTPUT of the spectrum analyzer to the INPUT of the amplifier. Connect a second SMA cable to the OUTPUT of the amplifier.
2. For 11970K: Zero and calibrate the power meter. For 11970A, 11970Q, 11970U, 11970V or 11970W: Connect the 478A Power Sensor to the power meter sensor cables, then zero the power meter.
3. Set the 8566A/B Spectrum Analyzer controls as follows:

SHIFT, ↑, KSU

FREQUENCY SPAN, 0, Hz

SHIFT, SWEEP, CONT, KSt

CENTER, 2, 4, [.] 5, GHz

CAUTION When you are using a 11975A Amplifier with a 11970 Series Mixer, you **MUST** set the amplifier rear-panel ALC switch to ON before you connect the amplifier into the test setup. If the ALC switch is left in the OFF position, the amplifier output power is high enough to destroy the mixer diodes.

4. On the 11975A Amplifier, set the rear panel ALC switch to ON, then connect the power sensor to the free end of the cable installed on the OUTPUT connector of the amplifier. Set the power meter Cal Factor to the appropriate value for a frequency of 4 GHz.
5. Adjust the amplifier OUTPUT POWER LEVEL for a reading of 14.0 ± 0.1 dBm on the power meter. Record the LO power in [Table 3-7](#).
6. Set the power meter Cal Factor to 100 percent.
7. Connect the equipment, as shown in [Figure 3-1](#).

CAUTION Make sure the 8349A Amplifier, used in the signal generator system for 11970A, Q and U tests, is set for external leveling before you turn it on. Failure to do so may allow the amplifier output to rise about 20 dBm (high enough to damage the frequency tripler).

8. Set the signal generator for a CW output signal at the frequencies listed below:
11970K: 18.0 GHz
11970A: 26.5 GHz
11970Q: 33.0 GHz
11970U: 40.0 GHz

11970V: 50.0 GHz

11970W: 75.0 GHz

9. Adjust the output power of the signal generator for a reading of approximately -10 dBm on the power meter for the 11970K, V or W and for approximately -3 dBm for the 11970A, Q or U. (Make sure that the unlevelled light is not on for the 11970V and 11970W. Vary the power by adjusting the rotary vane attenuator.)
10. On the spectrum analyzer, press **SHIFT** and [**MKR/Δ** ↑ **STP SIZE**].
11. Set spectrum analyzer **CENTER FREQUENCY** to:
 - 11970K: 22 GHz
 - 11970A: 33 GHz
 - 11970Q: 41 GHz
 - 11970U: 50 GHz
 - 11970V: 62 GHz
 - 11970W: 92 GHz
12. On the spectrum analyzer, press **SHIFT** and **SWEEP, CONT.**
13. Set the spectrum analyzer controls as follows:
 - For 11970K, A, Q or U:
 - SHIFT, REFERENCE LEVEL, 3, 0, -dB**
 - SCALE ENTER dB/DIV, 2, dB**
 - RES BW, 1, MHz**
 - FREQUENCY SPAN, 2, 0, MHz**
 - CF STEP SIZE, 5, 0, 0, MHz**
 - For 11970V or W:
 - SHIFT, REFERENCE LEVEL, 3, 0, -dB**
 - SCALE ENTER dB/DIV, 2, dB**
 - RES BW, 3, MHz**
 - FREQUENCY SPAN, 2, 0, 0, MHz**
 - CF STEP SIZE, 1, GHz**
 - Press **REFERENCE LEVEL**:
 - 11970K: 3, 6, -dBm
 - 11970A: 3, 8, -dBm
 - 11970Q: 4, 0, -dBm
 - 11970U: 4, 0, -dBm
 - 11970V: 4, 8, -dBm
 - 11970W: 5, 6, -dBm

Then press **CENTER FREQUENCY**:

11970K: 1, 8, GHz

11970A: 2, 6, [,] 5, GHz

11970Q: 3, 3, GHz

11970U: 4, 0, GHz

11970V: 5, 0, GHz

11970W: 7, 5, GHz

14. Press **MARKER, PEAK SEARCH**. If necessary, press **MKR→CF** and use **DISPLAY LINE ENTER** to find the average of the signal's peak variations. (When testing 11970V or 11970W mixers, it is important to re-zero the power meter for each measurement.)

15. Record the following in [Table 3-7](#):

Marker Frequency

Marker Amplitude

Power Meter Reading

Power Sensor Cal Factor or Correction Factor (dB)

Directional Coupler Coupling Factor

NOTE For the purposes of this measurement, the directional coupler coupling factor is defined as the ratio of the power at the output flange to the power at the coupled flange.

16. Calculate the conversion loss of the mixer with the following equation:

Conversion Loss = Power Meter Reading - 10 log(Cal Factor) - Spectrum Analyzer Marker Amplitude - Coupling Factor

(or given the Power Meter Correction Factor in dB: Conversion Loss = Power Meter Reading + Power Meter Correction Factor - Spectrum Analyzer Marker Amplitude - Coupling Factor)

For example:

Power Meter Reading = -10.03 dBm

Cal Factor = 94.8%

or Correction Factor = -0.232 dB

Spectrum Analyzer reading = -39.78 dBm

Coupling Factor 8.93 dB

then:

Conversion Loss (-10.03) - 10 log(.948) - (-39.78 dBm) - 8.93 dB = 21.05 dB

Performance Tests
Conversion Loss and Frequency Response

or Conversion Loss = $(-10.03 \text{ dBm}) - (-0.232) - (-39.78 \text{ dBm}) - 8.93 \text{ dB} = 21.05 \text{ dB}$

17. Record the conversion loss in [Table 3-7](#).

NOTE The conversion loss indicated on the mixer calibration label includes the loss in the IF cable. If other than the specified cable is used, then the loss in that cable must be compensated for when making amplitude measurements.

18. Increment the frequency of the signal generator 500 MHz higher.
19. Press DATA [↑], then **PEAK SEARCH** and **MKR**→**CF** on the spectrum analyzer.
20. Repeat steps 15 through 18 until the appropriate frequency listed below is reached.
 - 11970K: 26.5 GHz
 - 11970A: 40.0 GHz
 - 11970Q: 50.0 GHz
 - 11970U: 60.0 GHz
 - 11970V: 75.0 GHz
 - 11970W: 110.0 GHz
21. Repeat steps 1 through 19 for LO inputs to the mixer of 14.5 dBm, 16.0 dBm, and 18.0 dBm. In step 5, measure each of these levels at the end of the cable normally connected to the mixer LO input.
22. Frequency response is the difference between the maximum and minimum conversion losses recorded in [Table 3-7](#). For LO power levels between 14.5 and 16.0 dBm this difference must be less than:
 - 3.8 dB (for 11970K, 11970A, 11970Q or 11970U)
 - 4.2 dB (for 11970V)
 - 6.0 dB (for 11970W)
 - For LO power levels between 14.0 and 18.0 dBm, the difference must be less than:
 - 5.6 dB (for 11970K, 11970A, 11970Q, 11970U or 11970V)
 - 8.0 dB (for 11970W)
23. Maximum conversion loss must not exceed the following limits:
 - For an LO input power between 14.0 and 18.0 dBm.
 - 11970K: 24 dB
 - 11970A: 26 dB
 - 11970Q: 28 dB
 - 11970U: 28 dB
 - 11970V: 40 dB
 - 11970W: 46 dB

Figure 3-1 Performance Test Setups (1 of 2)

EQUIPMENT SETUP FOR
THE 11970K

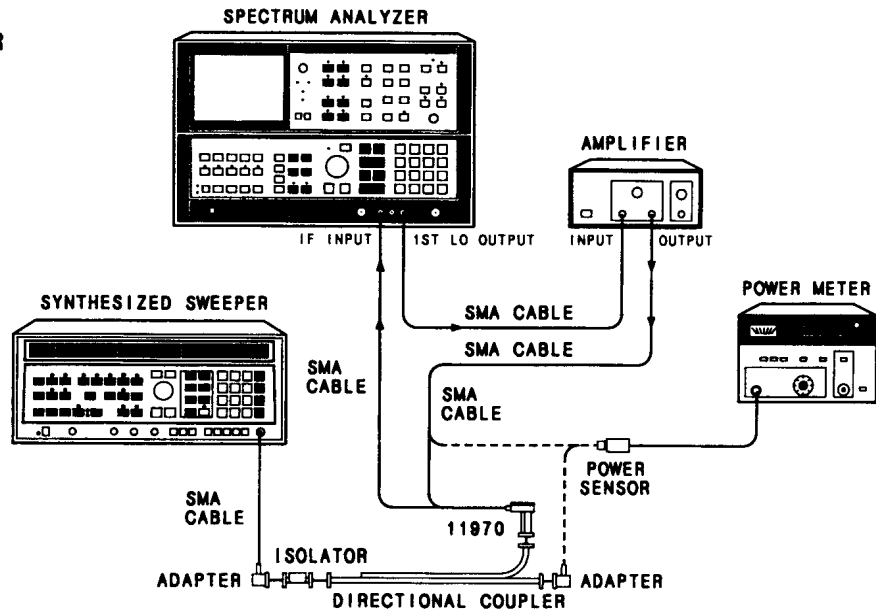

EQUIPMENT SETUP FOR
THE 11970A, 11970Q,
OR 11970U

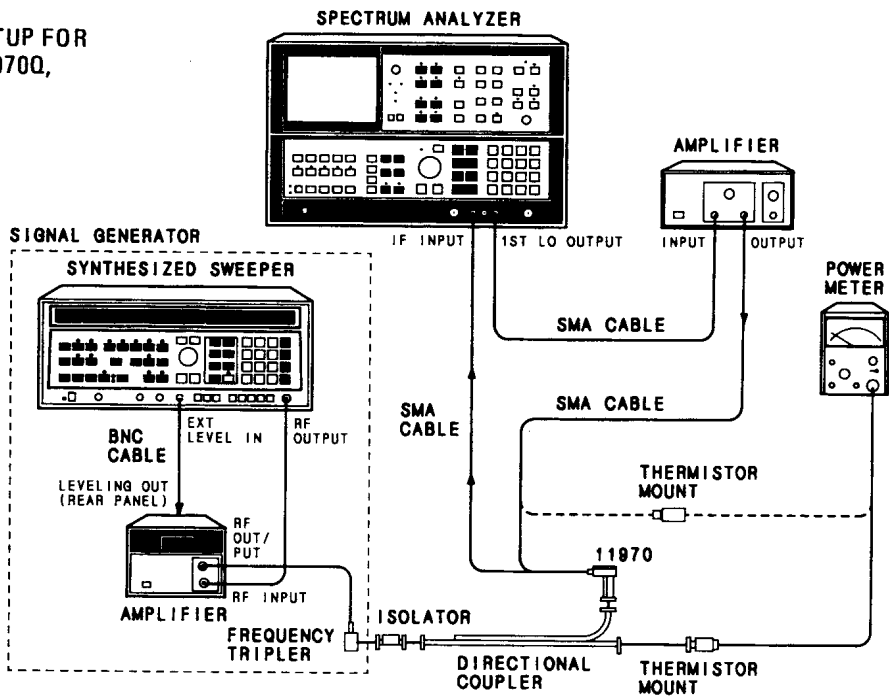

art4b

Figure 3-2 Performance Test Setups (2 of 2)

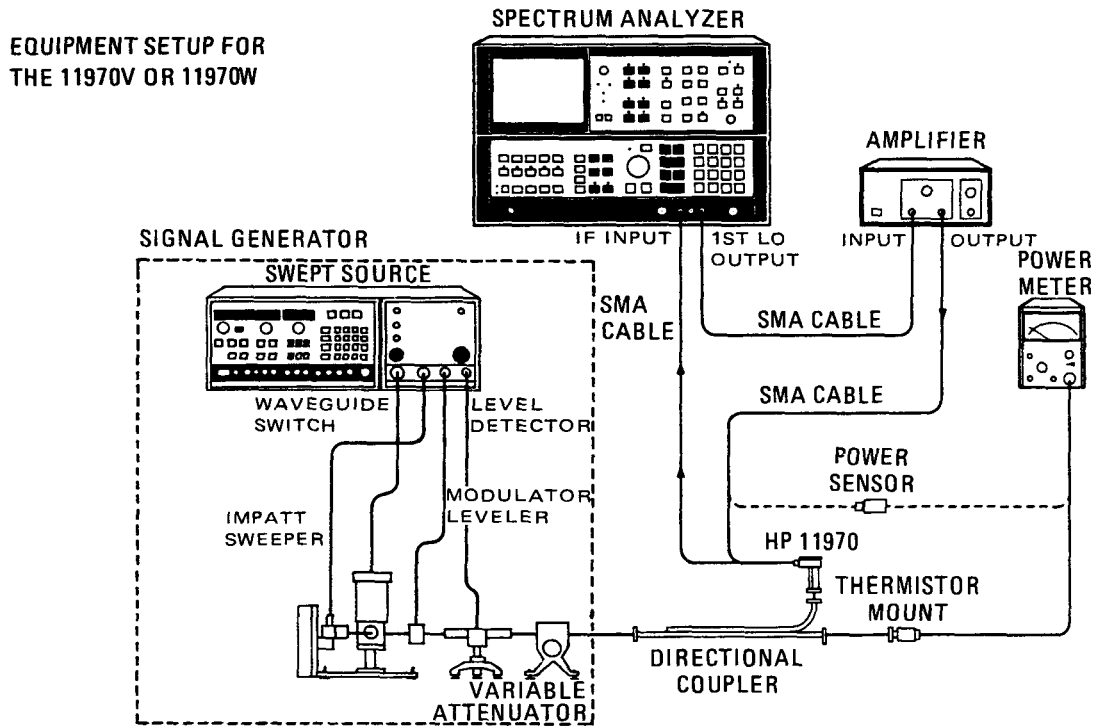

art5

AVERAGE NOISE LEVEL TEST

Specification

11970K: -110 dBm

11970A: -108 dBm

11970Q: -104 dBm

11970U: -104 dBm

11970V: -92 dBm

11970W: -85 dBm

Description

The average displayed noise level in a 1 kHz bandwidth, using external mixing with the 8566A/B Spectrum Analyzer, is checked at several LO power levels. This is accomplished by applying a known power to the input of the mixer. The difference between the amplitude of the known signal and the noise floor is measured. From these measurements, the average noise level in a 1 kHz bandwidth is calculated.

1. Connect an SMA cable from the spectrum analyzer LO OUTPUT to the INPUT of the 11975A Amplifier. Connect a second SMA cable to the amplifier OUTPUT.
2. For 11970K: Zero and calibrate the power meter. For 11970A, 11970Q, 11970U, 11970V or 11970W: Connect the 478A Power Sensor to the power meter sensor cables, then zero the power meter.
3. On the 8566A/B Spectrum Analyzer, set the controls as follows:

SHIFT, DATA STEP [↑] KSt

FREQUENCY SPAN, 0, Hz

SHIFT, SWEEP, CONT, KSt

CENTER FREQUENCY, 2, 4 [.] 5, GHz

CAUTION When you are using a 11975A Amplifier with a 11970 Series Mixer, you **MUST** set the amplifier rear-panel ALC switch to ON before you connect the amplifier into the test setup. If the ALC switch is left in the OFF position, the amplifier output power is high enough to destroy the mixer diodes.

4. On the 11975A Amplifier, set the rear panel ALC switch to ON. Then connect the power sensor to the free end of the cable connected to the output of the amplifier. Set the power meter calibration factor to the value shown on the power sensor calibration label for 4 GHz.
5. **Adjust the amplifier OUTPUT POWER LEVEL control for a reading of 14.5 ± 0.1 dBm on the power meter.**

CAUTION Make sure the 8349A Amplifier, used in the signal generator system for 11970A, Q and U tests, is set for external leveling before you turn it on. Failure to set this amplifier for external leveling may allow the amplifier output to rise about 20 dBm, which is high enough to damage the frequency tripler.

6. Disconnect the power sensor and connect the equipment as shown in [Figure 3-1](#).

7. On the 8566A/B Spectrum Analyzer, set the controls as follows:

For 11970K, A, Q or U:

SHIFT, DATA STEP [↑] K SU

FREQUENCY SPAN 3, 0, MHz

VIDEO BW, 1, 0, 0, Hz

RES BW, 1, 0, 0, kHz

For 11970V or W:

SHIFT, DATA STEP [↑] K SU

FREQUENCY SPAN, 1, 0, 0, MHz

VIDEO BW, 3, MHz

RES BW, 3, MHz

and **CENTER FREQUENCY:**

For 11970K: **2, 2, GHz**

For 11970A: **3, 3, GHz**

For 11970Q: **4, 1, GHz**

For 11970U: **5, 0, GHz**

For 11970V: **6, 2, [.] 5, GHz**

For 11970W: **9, 2, [.] 5, GHz**

8. Press **SHIFT** and **SWEEP, CONT, K St**.

9. Press **CENTER FREQUENCY** again and enter the appropriate center frequency as follows:

For 11970K: **1, 8, GHz**

For 11970A: **2, 6, [.] 5, GHz**

For 11970Q: **3, 3, GHz**

For 11970U: **4, 0, GHz**

For 11970V: 5, 0, GHz

For 11970W: 7, 5, GHz

10. Record the center frequency in [Table 3-8](#).
11. Set the power meter CAL FACTOR to the value shown on the sensor calibration label for the center frequency indicated on the spectrum analyzer.
12. Set the signal generator output to produce a CW signal near the center of the spectrum analyzer display. Next, set the signal generator output power level to produce a reading of approximately -10 dBm on the power meter. Record the power meter reading in [Table 3-8](#). (When testing the 11970V or W, re-zero the power meter for each measurement.)
13. Subtract the coupling factor for the directional coupler from the power meter reading, then add the power meter correction factor (dB) to the power meter reading. Record this corrected power reading in [Table 3-8](#).

Corrected Power Reading = Power Meter Reading - Coupling Factor + Power Meter Correction Factor.

For example:

$$(-10.03 \text{ dBm}) - 9.82 \text{ dB} + 0.73 = -19.1 \text{ dBm}$$

14. On the 8566A/B, press **MARKER**, **PEAK SEARCH**, then **MKR**→**REF LVL**. Record the marker amplitude in [Table 3-8](#).
15. Move the marker to the displayed noise floor, or turn off the CW signal, and record the marker amplitude in [Table 3-8](#). (Some sources may have excessive wide band noise when the RF signal is turned off, so that the noise floor must be measured with the signal left on.)

NOTE Step 15 requires a signal source with a wide band phase noise characteristic that is at least 6 dB better than the measured average noise level.

16. The Average Noise Level is calculated as follows:

Average Noise Level = Corrected Power Reading (step 13) - Marker Amplitude (step 14) + Marker Amplitude (step 15) - Measurement Bandwidth Correction Factor

$$11970K, A, Q \text{ and } U \text{ Bandwidth Correction} = 10\log(100\text{kHz}/ 1 \text{ kHz})$$

$$11970V \text{ and } W \text{ Bandwidth Correction} = 10\log(3\text{MHz}/ 1 \text{ kHz})$$

For example:

$$\text{Average Noise Level} = (-19.1 \text{ dBm}) - (-32.3 \text{ dBm}) + (-77.7 \text{ dBm}) - 34.77 \text{ dB} = -99.3 \text{ dBm}$$

17. Enter the calculated value in [Table 3-8](#).

The Average Noise Level must be less than:

-110 dBm (for the 11970K)

-108 dBm (for the 11970A)

Performance Tests
AVERAGE NOISE LEVEL TEST

-104 dBm (for the 11970Q)

-104 dBm (for the 11970U)

-92 dBm (for the 11970V)

-85 dBm (for the 11970W)

18. Enter the following push button commands on the 8566A/B:

MARKER, OFF

REFERENCE LEVEL, 0, dBm

19. Repeat steps 9 through 17 at the following center frequencies:

11970K: 22 and 26.5 GHz

11970A: 33 and 40 GHz

11970Q: 41 and 50 GHz

11970U: 50 and 60 GHz

11970V: 62 and 75 GHz

11970W: 92 and 110 GHz

20. Repeat steps 1 through 18 for a power level of 16.0 dBm at the 11970 Mixer LO connector.

Table 3-8 Average Noise Test Record

AVERAGE NOISE LEVEL									
Model Number _____ Date _____									
Serial Number _____ Tested By _____									
	Center Frequency	Power Meter Reading	Power Meter Correction Factor	Directional Coupler Coupling Factor	Corrected Power REading	Signal Marker Amplitude	Noise Floor Marker Amplitude	Bandwidth Correction Factor	Average Noise Level
Units	GHz	dBm	dB	dB	dBm	dBm	dB	dB	dBm
Step	10	12	13	13	13	14	15	16	16
LO Power = 14.5									
LO Power = 16.0									

4 Service

Maintenance

The only maintenance required for the 11970 Series Mixers is preventive maintenance. When you are not using your mixer, cover its waveguide input with its waveguide cap. Also, though the 11970 Mixers can absorb more punishment than is normal for such devices, you should avoid subjecting them to unnecessary shock or vibration.

Repairs

The 11970 Mixers are NOT field-repairable. If your mixer fails, DO NOT try to repair it yourself, you will void the warranty. Instead, notify the nearest Agilent office.

Replaceable Parts

For a list of replaceable parts and accessories, see [Table 4-2](#).

Circuit Description

A schematic diagram of a 11970 Series Harmonic Mixer is shown in [Figure 4-1](#). The mixer circuit employs two diodes arranged as an anti-parallel pair. These diodes are the termination for the open end of the waveguide output. By employing a matched diode pair, even harmonic mixing is enhanced while odd harmonic mixing is suppressed.

The waveguide input is exponentially tapered in both height and width. The height taper provides impedance matching between the high impedance waveguide input and the low, dynamic impedance of the diodes. The width taper creates a high-pass filter response which isolates the LO harmonics from the standard-height waveguide. Without this isolation, the LO harmonics would reflect from the standard-height waveguide back into the mixer and destructively interfere with the desired mixing product.

LO harmonics are confined to the immediate vicinity of the diode pair by the low-pass filter, which has as its first element a metal -insulator -semiconductor (MIS) capacitor. This improves the out-of-band response. The diplexer separates the 3 - 6 GHz LO signal from the 321.4 MHz IF signal.

Figure 4-1 11970 Series Mixer Schematic Diagram

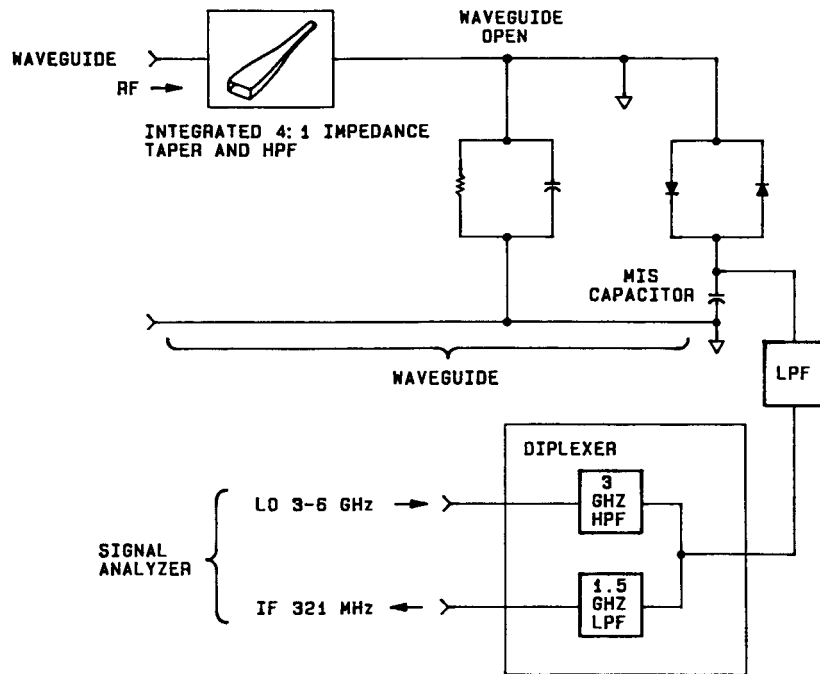

art6

Table 4-1

Model	LPF Fco (GHz)
11970K	4.4
11970A	5.0
11970Q	5.0
11970U	6.2
11970V	5.4
11970W	6.2

Table 4-2 Accessories and Replaceable Parts

Part Number	Description
5061-5460:	Mixer Connector Kit (Option 009), includes the following three items:
5061-5458	Cable, 1 meter long, SMA male connectors (3 required)
8710-0510	Wrench, 5/16-inch, open-end
8710-1539	Ball Driver, 3/32-inch
3030-0221	Socket Head Cap Screw, 4-40 thread, .375 inches long (flange connecting screw for 11970K and 11970A)
1390-0671	Socket Head Cap Screw, captive, 4-40 thread, .290 inches long (flange connecting screw for 11970Q, 11970U, 11970V or 11970W)
11970-40001	11970K Waveguide Cap
11970-40002	11970A Waveguide Cap
11970-40003	Waveguide Cap for 11970Q or 11970U
08486-40103	Waveguide Cap for 11970V or 11970W

Table 4-3 Agilent Technologies Sales and Service Offices

UNITED STATES		
Instrument Support Center Agilent Technologies (800) 403-0801		
EUROPEAN FIELD OPERATIONS		
Headquarters Agilent Technologies S.A. 150, Route du Nant-d'Avril 1217 Meyrin 2/ Geneva Switzerland (41 22) 780.8111	France Agilent Technologies France 1 Avenue Du Canada Zone D'Activite De Courtaboeuf F-91947 Les Ulis Cedex France (33 1) 69 82 60 60	Germany Agilent Technologies GmbH Agilent Technologies Strasse 61352 Bad Homburg v.d.H Germany (49 6172) 16-0
Great Britain Agilent Technologies Ltd. Eskdale Road, Winnersh Triangle Wokingham, Berkshire RG41 5DZ England (44 118) 9696622		
INTERCON FIELD OPERATIONS		
Headquarters Agilent Technologies 3495 Deer Creek Rd. Palo Alto, CA 94304-1316 USA (415) 857-5027	Australia Agilent Technologies Australia Ltd. 31-41 Joseph Street Blackburn, Victoria 3130 (61 3) 895-2895	Canada Agilent Technologies (Canada) Ltd. 17500 South Service Road Trans-Canada Highway Kirkland, Quebec H9J 2X8 Canada (514) 697-4232
Japan Agilent Technologies Japan, Ltd. Measurement Assistance Center 9-1, Takakura-Cho, Hachioji-Shi, Tokyo 192-8510, Japan TEL (81) -426-56-7832 FAX (81) -426-56-7840	Singapore Agilent Technologies Singapore (Pte.) Ltd. 150 Beach Road #29-00 Gateway West Singapore 0718 (65) 291-9088	Taiwan Agilent Technologies Taiwan 8th Floor, H-P Building 337 Fu Hsing North Road Taipei, Taiwan (886 2) 712-0404
China China Agilent Technologies 38 Bei San Huan X1 Road Shuang Yu Shu Hai Dian District Beijing, China (86 1) 256-6888		

Service
Maintenance

Free Manuals Download Website

<http://myh66.com>

<http://usermanuals.us>

<http://www.somanuals.com>

<http://www.4manuals.cc>

<http://www.manual-lib.com>

<http://www.404manual.com>

<http://www.luxmanual.com>

<http://aubethermostatmanual.com>

Golf course search by state

<http://golfingnear.com>

Email search by domain

<http://emailbydomain.com>

Auto manuals search

<http://auto.somanuals.com>

TV manuals search

<http://tv.somanuals.com>