

16700 Series Logic Analysis System

Product Overview



Debugging today's digital systems is tougher than ever. Increased product requirements, complex software, and innovative hardware technologies make it difficult to meet your time-to-market goals.

The Agilent Technologies 16700 Series logic analysis systems provide the simplicity and power you need to conquer complex systems by combining state/timing analysis, oscilloscopes, pattern generators, post-processing tool sets, and emulation in one integrated system.



Agilent Technologies

Table of Contents

System Overview	
Modular Design	page 3
Features and Benefits	page 4
Selecting the Right System	page 6
Mainframes	
Display	page 7
Back Panel	page 8
System Screens	page 9
IntuiLink	page 12
Probing Solutions	
Criteria for Selection	page 13
Technologies	page 14
Data Acquisition and Stimulus	
State/Timing Modules	page 17
Oscilloscope Modules	page 30
Pattern Generation Modules	page 33
Emulation Modules	page 37
Post-Processing and Analysis Tool Sets	
Software Tool Sets	page 39
Source Correlation	page 41
Data Communications	page 45
System Performance Analysis	page 54
Serial Analysis	page 61
Tool Development Kit	page 67
Licensing Information	page 73
Time Correlation with Agilent Infiniium Oscilloscopes	
E5850A Logic Analyzer - Oscilloscope Time Correlation Fixture	page 74
Technical Specifications and Characteristics	
Mainframe	page 75
Probing Solutions	page 83
State/Timing Modules	page 85
Oscilloscope Modules	page 101
Pattern Generation Modules	page 104
Trade-In, Trade-Up	page 115
Ordering Information	page 116
Third-Party Solutions	page 123
Support, Warranty and Related Literature	page 124
Sales Offices Information	page 125

System Overview

Modular Design

Modular Design Protects Your Long-Term Investment

Modularity is the key to the Agilent 16700 Series logic analysis systems' long term value. You purchase only the capability you need now, then expand as your needs evolve. All modules are tightly integrated to provide time-correlated, cross domain measurements.

Module Choices	User Benefits
State/Timing	Agilent offers a wide variety of state/timing modules for a range of applications, from high-speed glitch capture to multi-channel bus analysis.
High-Speed Timing	Precisely characterize setup/hold times over a wide channel count. Capture data over many clock cycles while retaining the highest multi-channel accuracy.
Oscilloscopes	Identify signal integrity issues and characterize signals quickly with automatic measurements of rise time, voltage, pulse width, and frequency.
Pattern Generation	Use stimulus to substitute for missing system components or to provide a stimulus-response test environment.
Emulation	An emulation module connects to the debug port (BDM or JTAG) on your target. You have full access to processor execution control features of the module through the built-in emulation control interface or a third-party debugger.

External Ports	
Target Control Port	Use the target control port to force a reset of your target or activate a target interrupt.
Port-in/Port-out	A BNC connector allows you to trigger or arm external devices or to receive signals that can be used to arm acquisition modules within your logic analyzer.

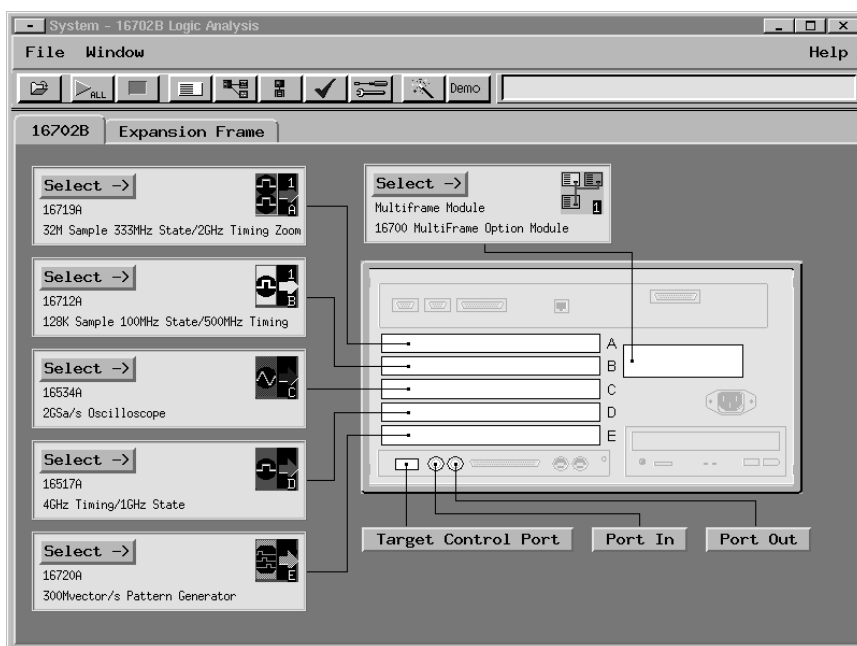

Help enables you to access the online user's guide and measurement examples.

Figure 1.1. The system boot up screen shows you what modules are configured into your logic analysis system.

System Overview

Features and Benefits

System Capability

NEW Touch Screen Interface	The Agilent 16702B mainframe supports a large, 12.1 inch LCD touch screen and redesigned front panel controls for an easy-to-operate, self-contained unit requiring minimal bench space and offering simple portability.
NEW Multiframe Configuration	By connecting up to eight mainframes and expanders you can simultaneously view time-correlated traces for all buses in a large channel count, multibus system.
NEW Enhanced Mainframe Hardware	Mainframe now includes a 40X CD-ROM drive, a 9 GB hard disk drive, 100BaseT-X LAN, and 128 MB of internal system RAM (optional 256 MB total).
Scalable System <ul style="list-style-type: none"> • State/timing analyzers • High-speed timing • Oscilloscopes • Pattern generators • Emulation modules 	<ul style="list-style-type: none"> • Select the optimum combination of performance, features, and price that you need for your specific application today, with the flexibility to add to your system as your measurement needs change. • View system activity from signals to source code.

Measurement Modules/Interfaces

The Agilent 16760A State/Timing Module	With up to 1.5 Gb/s state speed, the 16760A lets you debug today's and tomorrow's ultra-high-speed digital buses. NEW Eye scan gives a rapid comprehensive overview of signal integrity on hundreds of channels simultaneously
The Agilent 16750A, 16751A, and 16752A State/Timing Modules	With up to 400 MHz state speed and up to 32 MBytes of trace depth these modules help you address today's high-performance measurement requirements. (See page 19)
The Agilent 16720A Pattern Generator	With up to 16 MVectors depth and 300 MVectors/sec operation and up to 240 channels[1] of stimulus, the 16720A provides a new level of capability that makes complex device substitution a reality. Supports TTL, CMOS, 3.3V, 1.8V, LVDS, 3-state, ECL, PECL, and LVPECL.
High-Speed Bus Measurements Made Simple with Eye Finder Technology	Agilent's eye finder technology automatically adjusts the setup and hold on every channel, eliminating the need for manual adjustment and ensuring accurate state measurements on high-speed buses.
Timing Zoom Technology	Simultaneously acquire data at up to 2 GHz timing and 400 MHz state through the same connection. Timing Zoom is available across all channels, all the time. (See page 23)
VisiTrigger Technology	<ul style="list-style-type: none"> • Use graphical views and sentence-like structure to help you define a trace event. • Select trigger functions as individual trigger conditions or as building blocks to easily customize a trigger for your specific task.
Processor and Bus Support	<ul style="list-style-type: none"> • Get control over your microprocessor's internal and external data. • Quickly and reliably connect to the device under test. (See page 36)
Direct Links to Industry Standard Debuggers and High-Level Language Tools	<ul style="list-style-type: none"> • Debuggers provide visibility into software execution for systems running software written in C and C++ as well as active microprocessor execution control (run control). • Import symbol files created by your language tool. Symbols allow you to set up trigger conditions and review waveform and state listings in easily recognized terms that relate directly to the names used for signals on your target and the functions and variables in your code.
Direct Links to EDA Tools	<ul style="list-style-type: none"> • Use captured logic analysis waveforms to generate simulation test vectors. • Easily find problems by comparing captured waveforms with simulated waveforms.

[1] 240 channel system consists of five 16720A pattern generator modules with 48 channels per module. Full channel mode runs at 180 MVectors/s and 8 MVectors depth. 300 MVectors/s and 16 MVectors depth are offered in half channel mode.

System Overview

Features and Benefits

Data Transfer, Documentation, and Remote Programming

Direct Link to Microsoft® Excel via Agilent IntuiLink	<ul style="list-style-type: none"> Automatically move your data from the logic analyzer into Microsoft Excel with just a click of the mouse. (See page 12) Use Microsoft Excel's powerful functions to post-process captured trace data to get the insight you need.
Transfer Data for Offline Analysis - Data Export	<ul style="list-style-type: none"> Fast binary (compressed binary) from the FileOut tool provides highest performance transfer rate. ASCII format provides same format as listing display, including inverse-assembled data.
Transparent File System Access	<ul style="list-style-type: none"> Access, transfer, and archive files. Stay synchronized with your source code by mapping shared directories and file systems from your Windows 95/98/NT-based PC directly onto the logic analyzer and vice versa. Move data files to and from the logic analyzer for archiving or use elsewhere.
Documentation Capability	<ul style="list-style-type: none"> Save graphics in standard TIFF, PCX, and EPS formats. Print screen shots and trace listings to a local or networked printer. Save your lab notes and trace data in the same file by entering relevant information in the Comments tab of the display.
Remote Programming with Microsoft's COM Using Microsoft Visual Basic or Visual C++	<ul style="list-style-type: none"> Perform pass/fail analysis, stimulus response tests, data acquisition for offline analysis, and system verification and characterization tests. Powerful-yet-efficient command set focuses on your programming tasks, resulting in a shorter learning curve while maintaining necessary functionality.

System Software Features

Post-Processing Analysis Tools	Rapidly consolidate large amounts of data into displays that provide insight into your system's behavior. (See page 38)
Setup Assistant	Quickly configure the logic analysis system for your target microprocessor. (See page 9)
Tabbed Interface	<ul style="list-style-type: none"> Groups like tasks together so you can quickly find and complete the task you want to perform. Spend your time solving problems, not setting up a measurement.
Multi-Windowed View of Target System Activity	<ul style="list-style-type: none"> View your cross-domain measurements, time-corrected on the same screen. (See page 10) Debug faster because you can view system activity at a glance.
Global Markers	Track a symptom in one domain (e.g., timing) to its cause in another domain (e.g., analog).
Resizable Windows and Data Views	<ul style="list-style-type: none"> Magnify your view or zoom in on a boxed area of interest. Resize waveforms and data or quickly change colors to highlight areas of interest.
Web-Enabled System	<ul style="list-style-type: none"> Directly access the instrument's web page from your web browser. (See page 11) Remotely check the instrument's measurement status without disturbing the acquisition. Remotely access, monitor and control your logic analysis system.
Network Security	<ul style="list-style-type: none"> Protect your networked assets and comply with your company's security requirements with individual user logins that provide system integrity.
NEW Time Correlation with Infiniium 54800 Series Oscilloscopes	<ul style="list-style-type: none"> Make time-correlated measurements using an Agilent 16700 Series logic analyzer and an Agilent Infiniium 54800 Series oscilloscope. View Infiniium oscilloscope waveforms in the 16700 logic analyzer's waveform display. Use the 16700 logic analyzer's global markers to measure time between any domain in the 16700 and voltage waveforms acquired by the Infiniium oscilloscope.

System Overview

Selecting the Right System

Selecting a system for your application

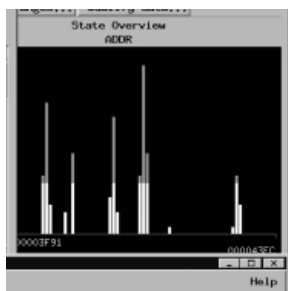
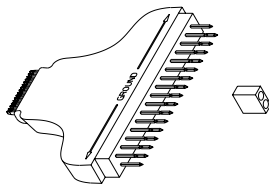
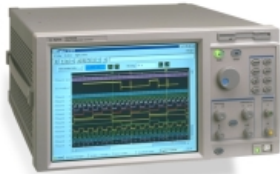

Select a mainframe (page 7)

Choose a system based on your needs:

- Self-contained unit or a unit with external mouse, keyboard, and monitor
- Expander frame for large channel count requirements



Determine your probing requirements (page 13)

- Are you analyzing a microprocessor?
- Do you need to probe a specific package type?



Select the measurement modules to meet your application needs

- State/Timing Logic Analyzers (page 17)
- Oscilloscopes (page 29)
- Pattern Generation (page 32)
- Emulation (page 36)



Add post-processing tool sets for analysis and insight (page 38)

- Source correlation
- Data communications
- System performance analysis
- Serial analysis
- Tool development kit



Support, services, and assistance (page 123)

- Training classes
- Consulting
- On-line support
- Warranty extension

Mainframes Display

12.1" LCD display with touch screen on the 16702B makes it easy to view a large number of waveforms or states.

Select a modifiable variable by touching it, then turn the knob to quickly step through values for the variable.

Dedicated hot keys give instant access to the most frequently used menus, displays, and on-line help.



Dedicated knobs for horizontal and vertical scaling and scrolling. Adjust the display to get just the information you need to solve your problem.

"Touch Off" button disables the touch screen and allows you to point out a anomalies to a colleague without altering the display settings.

Dedicated knobs for global markers help track down tough problems. A symptom seen in one domain (e.g., timing) can be tied to its cause in another domain (e.g., analog).

Figure 2.1. The Agilent 16702B quickly tracks down problems in your design while saving precious bench space.

Mainframes

Back Panel



Figure 2.2. The mainframe and expander frame provide advanced capabilities for debugging complex target systems.

Mainframes System Screens



Figure 2.3. Icons in the power-up screen give you quick access to common tasks.

System Admin allows you to quickly set up the instrument on your network, configure print servers, set up user accounts for security or install software updates.

Setup Assistant is a guided menu system that helps you configure the logic analysis system for your target microprocessor or bus. Online information guides you through the setup. (See figure 2.4)

Demo Center provides simple demos of the most commonly used features.

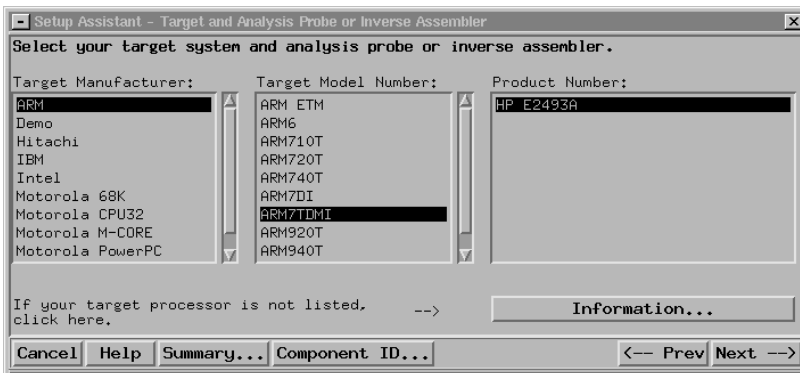

Figure 2.4. Setup Assistant gets you up and running quickly.

Mainframes System Screens

See the Big Picture of Your Prototype System's Behavior

A large external display (option 001) with multiple, resizable windows allows you to see at a glance more of your target system's operation. A built-in, flat-panel display in the 16702B fits in environments with limited space. Color lets you highlight critical information so you can find it quickly.

Use one system to examine target operation from different perspectives. Multiple time-correlated views of data let you confirm both signal integrity and software execution flow. These views are invaluable in solving cross-domain problems.

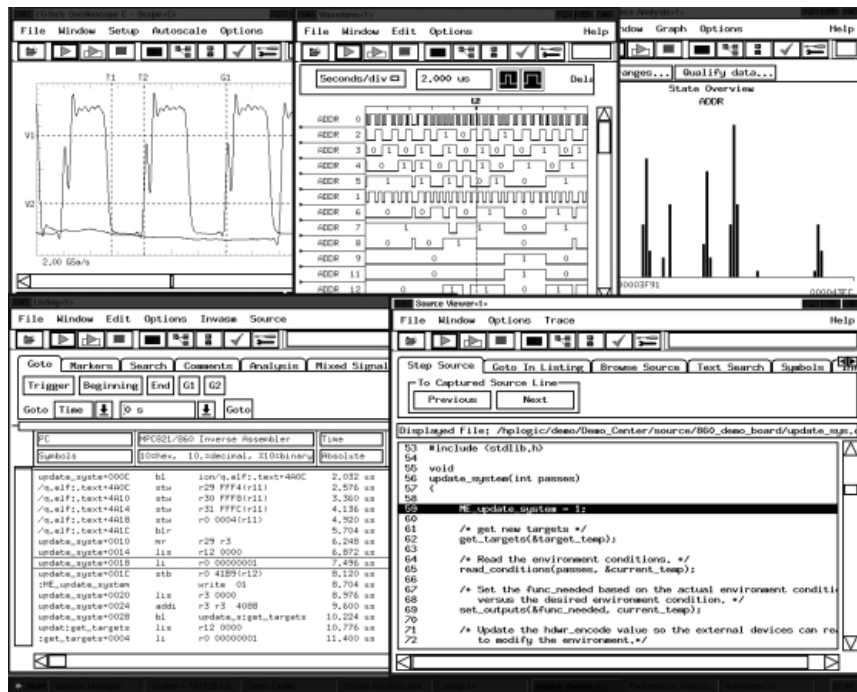

Figure 2.5. You can quickly isolate the root cause of system problems by examining target operation across a wide analysis domain, from signals to source code.

Mainframes System Screens

Expanding Possibilities with Network Connectivity

Web-enabled instrumentation gives you the freedom to access the system—anywhere, anytime. Have you ever needed to check on a measurement's status while you were in a remote location? Now you can.

With a Web Enabled Logic Analysis System You Can...

...install Agilent IntuiLink to seamlessly transfer data from the system to a PC

...access Agilent's Web site for the latest online manuals and technical information

...access the logic analysis system's Web page from your browser by using the instrument's hostname as a URL

...access the system's user interface directly from within your browser, giving you full control of all analysis functions

...remotely check current measurement status to find out if the system has triggered

...quickly check instrument status to determine if the system is available for use

The screenshot shows a Microsoft Internet Explorer browser window with the title "Welcome to Agilent Technologies Web-Enabled Site - Microsoft Internet Explorer provided by Hewlett Packard". The address bar contains "http://vikingb02/". The page header includes "Agilent Technologies" and "16700 Series Logic Analysis System". A navigation bar at the top right contains links for "Download IntuiLink", "ClearCase Support", "Advanced", "Products", and "Agilent Site". A left-hand navigation menu includes icons and labels for "Welcome Page", "Browser Web Control", "X-Window Web Control", "Get Image", "System Status", "Browse Files", "Print Display", and "Help with this Page". The main content area displays "Welcome to your Web Enable Logic Analyzer" and a "Your Current Connection Is:" section with the following data:

URL:	http://vikingb02.cos.agilent.com
IP Address:	130.29.67.17
Status:	A user on the console has been using the logic analyzer since 01/03/01 at 11:09 pm.
Shared Connections:	none

To the right of this section is a photograph of the logic analyzer hardware.

Figure 2.6. Your logic analyzer is its own web site. From the Home Page, you can perform multiple remote functions.

Mainframes

IntuiLink

Agilent IntuiLink Moves Your Data Automatically into Microsoft® Excel for Advanced Offline Analysis

IntuiLink is shipped with each logic analysis system and can be downloaded to your PC from the system's own web page. Use the Agilent IntuiLink tool bar to connect to a logic analysis system. Select from the available labels and specify the destination cell location in Microsoft Excel.

Use Microsoft Excel's powerful functions to post-process captured trace data for the insight you need.

Import data from a current acquisition or data previously saved to a file via the File Out tool.

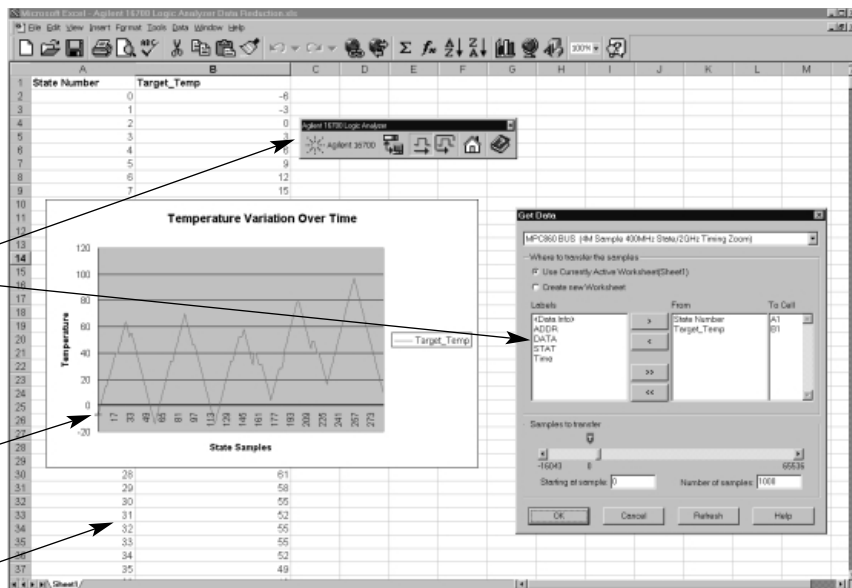

Figure 2.7. Transfer data into Microsoft Excel with just a click of the mouse.

Programming

IntuiLink also includes an Active-X automation server to provide programmatic control of the logic analysis system from an external environment, such as LabVIEW or the Microsoft VisualStudio environment of Visual Basic and Visual C++ tools. The instrument's Remote Programming Interface (or RPI) also allows you to write Perl or other scripts to control the logic analyzer. Use the sample programs provided to assist you in creating your own custom programs.

Probing Solutions

Criteria for Selection

Why is Probing Important?

Your debugging tools perform three important tasks: probing your target system, acquiring data, and analyzing data. Data acquisition and analysis tools are only as effective as the physical interface to your target system. Use the following criteria to see how your probing measures up.

How to Determine Your Requirements

To determine what probing method is best to use you need to take the following into consideration:

- The number of signals to be probed
- The ability to design probing connectors on the target PC board itself
- Mechanical probing clearance requirements
- Signal loading effects
- Ease of attachment
- Package type to be probed
 - DIP Dual In-line Package
 - PGA Pin Grid Array
 - BGA Ball Grid Array
 - PLCC Plastic Leaded Chip Carrier
 - PQFP Plastic Quad Flat Pack
 - TQFP Thin Quad Flat Pack
 - SOP Small Outline Package
 - TSOP Thin Small Outline Package
- Package Pin Pitch (distance between pin centers)

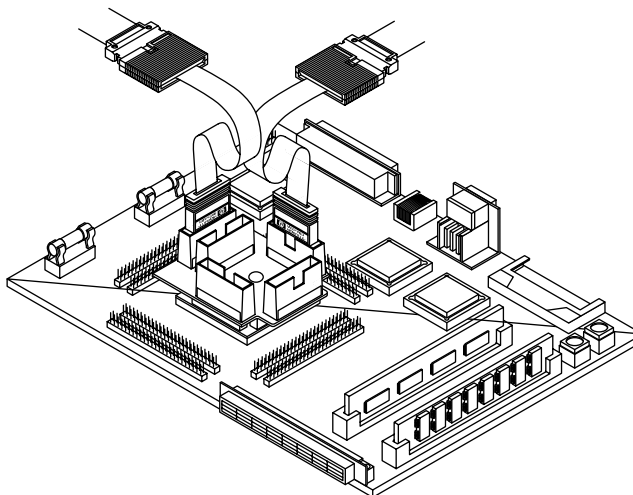

Figure 3.1. A rugged connection lets you focus on debugging your target, not your probe.

Immunity to Noise	EMF noise is everywhere and can corrupt your data. Active attenuator probing can be particularly susceptible to noise effects. Agilent Technologies designs probing solutions with high immunity to transient noise.
Impedance	High input impedance will minimize the effect of probing on your circuit. Although many probes are acceptable for lower frequencies, capacitive loading dominates at higher frequencies.
Ruggedness	A flimsy probe will give you unintended open circuits. Agilent Technologies' probes are mechanically designed to relieve strain and ensure a rugged and reliable connection.
Connectivity	A multitude of device packages exist in the digital electronics industry. Check our large selection of probing solutions designed for specific chip packages or buses. As an alternative, we offer reliable termination adapters that work with standard on-target connectors.

Probing Solutions Technologies

Choose the Optimum Probing Strategy for Your Application

Connecting to individual test points with flying leads

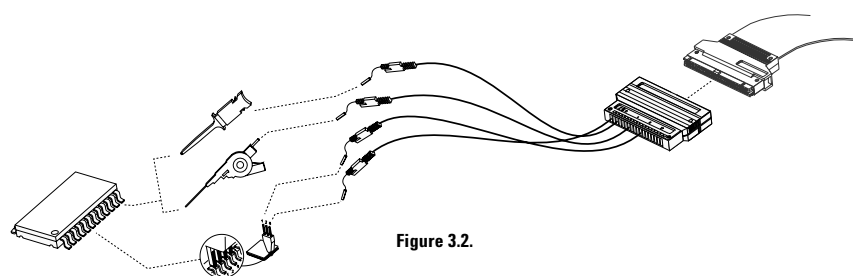

Figure 3.2.

Advantages

Most flexible method. Flying-lead probes are included with logic analyzer module (except 16760A).

Limitations

Can be time-consuming to connect a large number of channels. Least space-efficient method.

Connecting to all the pins of a quad flat pack (QFP) package

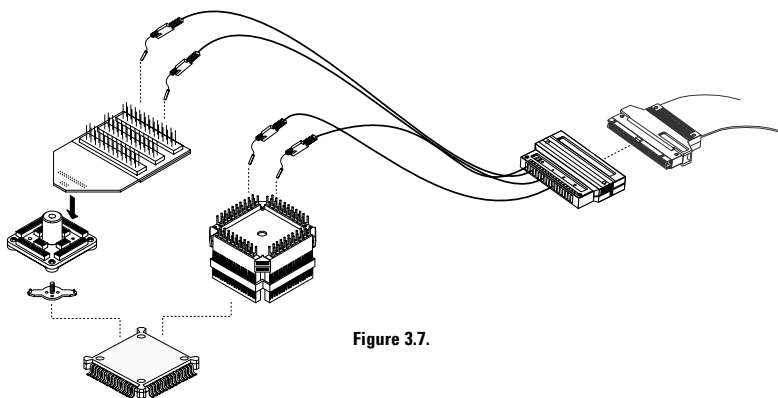

Figure 3.7.

Advantages

Rapid access to all pins of fine-pitch QFP package. Very reliable connections.

Limitations

Requires minimal keepout area.

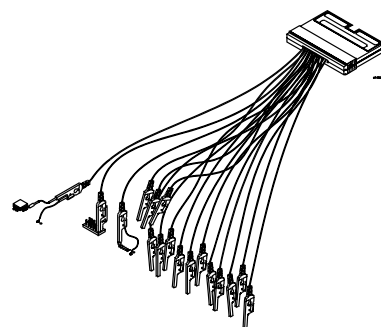

NEW Figure 3.3. The E5382A single-ended flying lead probe set provides connections for 17 channels of the 16760A logic analyzer.



Figure 3.4. Surface mount IC clip. 5090-4356 (20 clips).

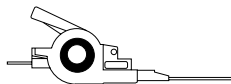

Figure 3.5. 0.5 mm IC clip. 10467-68701 (4 clips).

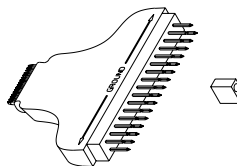

Figure 3.6. Wedge adapters connect to multiple pins of 0.5 mm or 0.65 mm QFP ICs. Refer to "Probing Solutions for Agilent Technologies Logic Analysis Systems," publication number 5968-4632E, for specific part numbers.

Refer to "Probing Solutions for Agilent Technologies Logic Analysis Systems," publication number 5968-4632E, for specific solutions.

Probing Solutions Technologies

Designing connectors into the target system

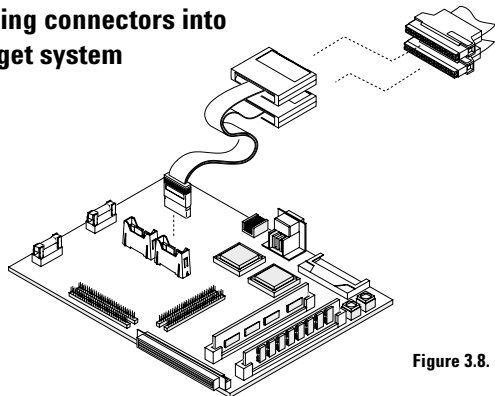

Figure 3.8.

Advantages

Very reliable connections.
Saves time in making multiple connections.

Limitations

Requires advance planning in the design stage.
Requires some dedicated board space.
Moderate incremental cost.

High-density probing solutions

Model number	Description	Requires kit of 5 connectors and 5 shrouds	Usable with logic analyzers
E5385A	100-pin probe with built-in isolation networks for the logic analyzer	16760-68701	All except 16517A, 16518A, 16760A
E5346A	34-channel, 38-pin probe with built-in isolation networks for the logic analyzer.	E5346-68701	All except 16517A, 16518A, 16760A
E5351A	34-channel 38-pin adapter cable, requires logic analyzer isolation networks on the target.	E5346-68701	All except 16517A, 16518A, 16760A
E5339A	34-channel 38-pin low-voltage probe with built-in isolation networks for the logic analyzer. Designed for signals with peak-to-peak amplitude as small as 250 mV.	E5346-68701	All except 16517A, 16518A, 16760A
E5378A	34-channel 100-pin single-ended probe for 16760A	16760-68701	16760A only
E5379A	17-channel 100-pin differential probe for 16760A	16760-68701	16760A only
E5380A	34-channel 38-pin single-ended probe for 16760A	E5346-68701	16760A only

Moderate-density probing solutions

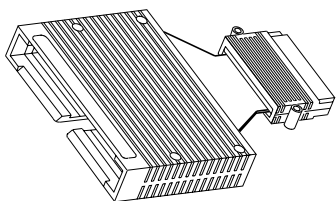

Figure 3.9. 01650-63203 termination adapter.

The Agilent 01650-63203 isolation adapter contains the termination networks for the logic analyzer. The 01650-63203 connects to a 3M 20-pin connector on the target PC board. Refer to "Probing Solutions for Agilent Technologies Logic Analysis Systems," publication number 5968-4632E, for design guidelines and part numbers for mating connectors.

You may also add the isolation networks to the target PC board and connect the logic analyzer cable directly to a 40-pin 3M connector on the PC board. Refer to "Probing Solutions for Agilent Technologies Logic Analysis Systems," publication number 5968-4632E, for design guidelines in addition to part numbers for mating connectors and isolation networks.

Probing Solutions Technologies

Using a processor- or bus-specific analysis probe

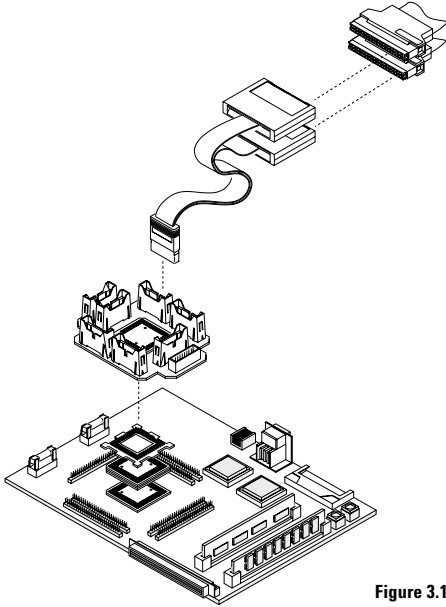

Figure 3.10.

Advantages

Easiest and fastest connection to supported processors and buses.

Limitations

Moderate to significant incremental cost.
Only useable for the specific processor or bus.
May require moderate clearance around processor or bus.

Refer to "Processor and Bus Support for Agilent Technologies Logic Analyzers," publication number 5966-4365E, for specific solutions.

Data Acquisition and Stimulus

State/Timing Modules

Selecting the Correct Modules to Meet Your Needs

Selecting the proper logic analyzer modules for your needs requires a series of choices concerning

performance, cost, and the amount of data you will be able to capture. The following table explains these factors in greater detail.

Considerations for Choosing Modules

Microprocessor/ Bus Support	Will you be using an analysis probe for a particular processor or bus? If so, a good starting point is the document Processor and Bus Support for Agilent Technologies Logic Analyzers, publication number 5966-4365E, available on the worldwide web at www.agilent.com/find/logicanalyzer . This document provides the number of channels and state speed required for any particular analysis probe. It also indicates which analysis modules are supported and how many are required.
State Speed	<ul style="list-style-type: none"> State analysis uses a clock or strobe signal from your system under test to determine when to sample. Because state analysis samples are synchronous with the system under test, they provide a view of how your system is executing. You can use state analysis to capture bus cycles from a microprocessor or I/O bus and convert the data into processor mnemonics or bus transactions using an Agilent Technologies inverse assembler. Select a state acquisition system that provides the speed and headroom you need without breaking your budget. Remember that a microprocessor will have an internal core frequency that is normally 2X-5X the speed of the external bus.
Headroom	You may realize a better return on your investment if you consider possible future needs when purchasing analysis modules. The things to consider are primarily state speed and memory depth.
Setup/Hold	<ul style="list-style-type: none"> Logic analyzers require time for the data at the inputs to become valid (setup time), and time to capture the data (hold time). A lengthy setup and hold can make the difference between capturing valid data or data in transition. Your device under test will ensure that data is valid on the bus for a defined length of time. This is known as the data valid window. Your target's data valid window must be large enough to meet the setup/hold specifications of the logic analyzer. The data valid window of most devices is generally less than half of the clock period. Don't be fooled by "typical" setup and hold specifications for logic analyzers. As bus speeds increase, the time window during which data is stable decreases. Jitter, skew, and pattern-dependent ISI add more uncertainty and consume a greater portion of the data-valid window at high speeds. A logic analyzer with adjustable setup/hold with fine position resolution provides unparalleled measurement accuracy at high frequencies.
Timing Resolution	Timing analysis uses the logic analyzer's internal clock to determine when to sample. Since timing analysis samples asynchronously to the system under test, you should consider what accuracy you will need to verify your system. Accuracy is made up of two elements: sample speed and channel-to-channel skew. Remember to evaluate both of these elements and be careful of logic analyzers that have a fast sample speed with a large channel-to-channel skew.
Transitional Timing	If your system has bursts of activity followed by times with little activity, you can use transitional timing to capture a longer trace. In transitional timing, the analyzer samples data at regular intervals, but only stores the data when there is a transition on one of the signals.

Data Acquisition and Stimulus State/Timing Modules

Considerations for Choosing Modules (continued)

Channel Count	Determine the number of signals you want to analyze on your system under test. You will need this number of channels in your logic analyzer. Even if you have enough channels to view all the signals in your system today, you should consider logic analysis systems that allow you to add more channels for your future application needs.
Memory Depth	<ul style="list-style-type: none">• Complex architectures and bus protocols make your debugging job increasingly challenging. Split transactions, multiple outstanding transactions, pipelining, out-of-order execution, and deep FIFOs, all mean that the flow of data related to a problem can be distributed over thousands or millions of bus cycles.• The keys to useful insight are the combination of deep memory with responsive display refresh, search, rescaling, and scrolling to help you find information and answers quickly. Hardware-assisted memory management in the Agilent 16740A, 16741A, 16742A, 16750A, 16751A, 16752A, and 16760A state and timing analysis modules makes quick work of refreshing the display, rescaling, scrolling, and searching. It takes only a few seconds to refresh, rescale, or scroll a 32M sample record. Agilent Technologies offers a range of state and timing analyzer modules with memory depths up to 128M samples, at prices to meet your budget.
Triggering	<ul style="list-style-type: none">• The logic analyzer memory system is similar to a circular buffer. When the acquisition is started, the analyzer continuously gathers data samples and stores them in memory. When memory becomes full, it simply wraps around and stores each new sample in the place of the sample that has been in memory the longest. This process will continue until the logic analyzer finds the trigger point. The logic analyzer trigger stops the acquisition at the point you specify and provides a view into the system under test. The primary responsibility of the trigger is to stop the acquisition, but it can also be used to control the selective storage of data. Consider a logic analyzer with the trigger resources you need to quickly set up your measurements.• After memory depth, triggering is the most important aspect of a logic analyzer to consider. On the one hand, powerful triggering resources and algorithms will allow you to focus on potential problem sources without using up valuable memory. On the other hand, to be useful, the trigger must be easy to set up.
Other Measurements	In addition to the measurements made with an analysis probe, consider whether you need to monitor other signals. Be sure to allow enough channels to make those measurements. For state measurements, the state speed of the analyzer must be at least as high as the clock speed of your circuit. You may want to test the margin in your circuit by operating it at higher than the nominal clock speed to determine if the analyzer has sufficient clock speed. For timing measurements, the timing analyzer rate should be from 2-10X the clock speed of your target.

Data Acquisition and Stimulus State/Timing Modules

Key Features of Agilent's State/Timing Modules

- Memory depth up to 128M samples at a price to meet your budget
- State analysis up to 1.5 Gb/s
- Timing analysis up to 2 GHz
- VisiTrigger combines powerful functionality with an intuitive user interface
- Timing Zoom 2-GHz timing on all channels
- Eye finder for automatic setup and hold on all channels

Multichannel Eye measurements	Eye scan allows you to make eye diagram measurements, quickly and easily, on hundreds of channels simultaneously (16760A only)
Triggering for the most elusive problems	VisiTrigger combines powerful trigger functionality with a user interface that is easy to understand and use. Capturing complex sequences of events is as simple as pointing to the function you want to use and filling in the blanks to customize it to your specific situation.
Reliable measurements on high-speed buses	Eye finder automatically adjusts the setup and hold on every channel, eliminating the need for manual adjustment and ensuring the highest confidence in accurate state measurements on high-speed buses.
High-speed timing on all channels	Timing Zoom provides the data acquisition speed you need for high-speed microprocessors and buses.

Choose the Logic Analyzer and Measurement Modules that Best Fit Your Application

State/Timing Modules	General-purpose hardware debug	8/16 Bit processor debug	32/64 Bit processor debug or channel intensive systems	High-speed bus analysis	Timing margin analysis or characterize setup/hold	Deep trace capture with timing or state analysis	High-speed computer debug	Analysis of data intensive systems and performance
16710A	√	√						
16711A	√	√						
16712A	√	√						
16715A			√			√	√	
16716A	√	√	√		√		√	
16717A			√	√	√	√	√	
16740A			√	√	√	√	√	√
16741A			√	√	√	√	√	√
16742A			√	√	√	√	√	√
16750A			√	√	√	√	√	√
16751A			√	√	√	√	√	√
16752A			√	√	√	√	√	√
16760A				√		√	√	

A variety of measurement modules allow you to select the optimum combination of performance, features, and price to meet your specific needs now and in the future.

Data Acquisition and Stimulus State/Timing Modules

Improve Your Productivity with an Intuitive User Interface

Agilent Technologies has made the user interface easy to understand and use. Now you can spend more time making measurements and less time setting up the logic analyzer.

Timing Zoom provides 2 GSa/s timing analysis simultaneous with state or conventional timing analysis on all channels. Sampling rate and position relative to trigger are adjustable (16716A, 16717A, 16740A, 16741A, 16742A, 16750A, 16751A, and 16752A only).

Format allows you to group signals into buses.

Trigger defines what data is acquired.

Sampling defines how the logic analyzer will acquire the data.

Measurement configuration and data files can be loaded directly into the logic analyzer

Menu tabs provide a logical progression through the setup of your measurement.

State and timing mode selections specify how data is sampled.

Single location for access to all state acquisition options.

Convenient color coding helps you identify the signals in the interface with the physical connection to your device under test.

Clocking for state measurements can be quickly defined using the clock setup menu.

The screenshot shows the software interface with the following elements:

- File Window Help** menu bar.
- Toolbar with icons for file operations and a text box: "<Click> to insert, delete, or replace an event".
- Menu tabs: **Sampling**, **Format**, **Trigger**, **Symbol**.
- Analyzer Name: **Analyzer<C>** with a **On** checkbox and a **Timing Zoom...** button.
- Timing Mode** - Asynchronous sampling clocked internally by analyzer (selected).
- State Mode** - Synchronous sampling clocked by the Device Under Test.
- State Mode Controls**:
 - 333 MHz / 32M State (dropdown)
 - Trigger Position: Center (dropdown)
 - Acquisition Depth: 32M (dropdown)
- Clock Setup**:
 - Mode: Master only (dropdown)
 - Pod: C3, C2, C1
 - Clock: M, L, K, J
 - Activity: -, -, -, +
 - Master: + => J1

Figure 4.1. Setting up your logic analyzer has never been this easy.

Data Acquisition and Stimulus State/Timing Modules

VisiTrigger Quickly Locates Your Most Elusive Problems

VisiTrigger technology is a breakthrough in logic analysis usability. It combines increased trigger functionality with a user interface that is easy to understand and use. Now with VisiTrigger, capturing complex events is as simple as pointing to the trigger function and filling-in-the-blanks.

Features and Applications

VisiTrigger (available in the 16715A, 16716A, 16717A, 16740A, 16741A, 16742A, 16750A, 16751A, 16752A, and 16760A state/timing modules)

- Use graphical views and sentence-like structures to help you define a trace event.
- Select trigger functions as individual trigger conditions or as building blocks to easily customize a trigger for your specific task.
- Set global counters to count events such as the number of times a function executes, or the number of accesses to an I/O port.
 - Set, clear or evaluate flags by any module in the frame. Flags allow you to set up a trigger that is dependent on activity from more than one bus in the system.
- Specify four-way arbitrary IF/THEN/ELSE branching.

Examples of Problems that Can be Captured Easily with VisiTrigger

Description	Typical Applications	Graphic
Pulse too narrow or too wide	<ul style="list-style-type: none"> • Line hangs at wrong level (high or low). • Asynchronous input (for example, an interrupt) persists too long. • Strobe width is too narrow or too wide. 	
Time between two edges is longer than specified	<ul style="list-style-type: none"> • Excessive delay in responding to a bus grant request. • Excessive delay in responding to a data valid with a data acknowledged. 	
Pattern lasts longer than a specified time	<ul style="list-style-type: none"> • A bus hangs up at a given value. 	
Pattern two exists within a specified time after pattern one is detected	<ul style="list-style-type: none"> • An incorrect response to a read or write. • An incorrect output from a FIFO or bridge. 	
A pattern exists for less than a specified time	<ul style="list-style-type: none"> • A driver is not holding a bus value long enough for a receiver to respond. 	

Data Acquisition and Stimulus State/Timing Modules

VisiTrigger

Your most commonly used triggers are just a mouse click away with the built-in trigger functions. VisiTrigger's graphical representation shows you how the trigger condition will be defined. You can use trigger functions as building blocks to easily customize a trigger for your specific task.

Sequence levels allow you to develop a sequence of analyzer instructions to specify a trigger point or to qualify data and store only the information that interests you. Each step in the sequence contains an "IF/THEN/ELSE" structure that can evaluate up to four logic events. Each event can specify a combination of actions such as: store sample, increment counters, reset timers, trigger, or go to another step in the sequence level.

Ranges provide a way to monitor program and data accesses within a specified area in memory.

Global counters can count events such as the number of times a function executes or accesses an I/O port.

Timers can be set up to evaluate when one event happens too late or too soon with respect to another event.

In timing mode, edge terms let you trigger on a rising edge, falling edge, either edge, or a glitch.

Patterns and their logical combinations let you identify which states to store, when to branch and when to trigger.

View current information on the state of the timers, counters, flags, and the trigger sequence level.

Save and recall up to ten of your custom trigger setups without loading a new configuration file.

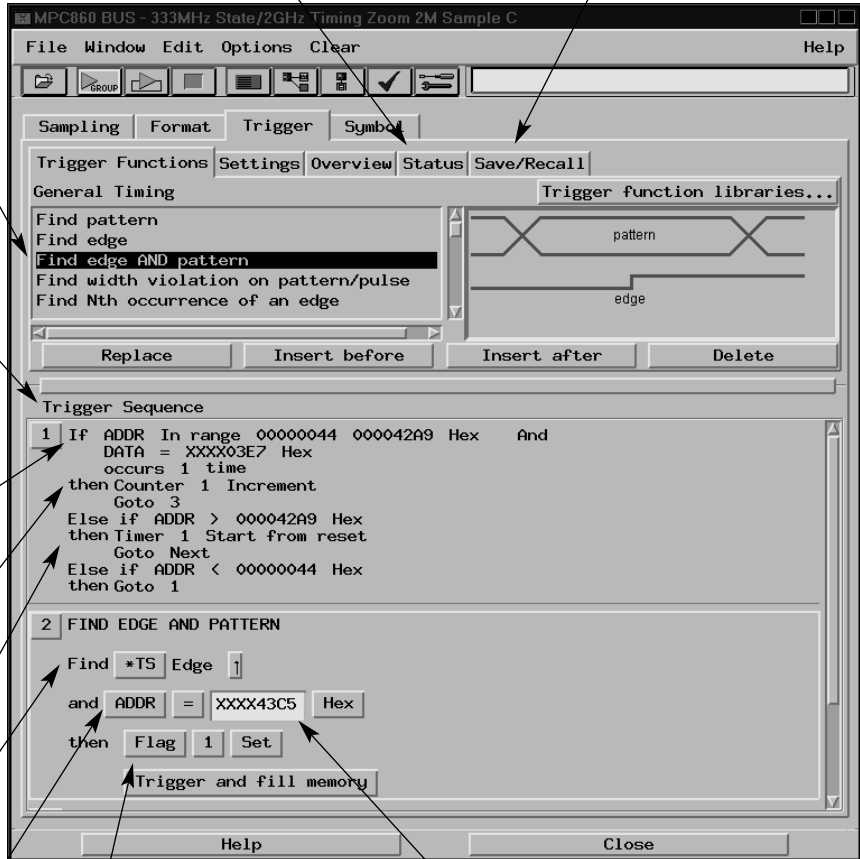

Flags can be set, cleared and evaluated by any 16715A/16A/17A/40A/41A/42A/50A/51A/52A/60A module in the frame. This allows you to set up a trigger that is dependent on activity from more than one bus in the system.

Values can be easily entered directly into the trigger description.

Figure 4.2. Set up your trigger in terms of the measurements you want to make.

Data Acquisition and Stimulus State/Timing Modules

2 GHz Timing Zoom Provides High-Speed Timing Analysis Across All Channels, All the Time

When you're pushing the speed envelope, you may run into elusive hardware problems. Capturing glitches and verifying that your design meets critical setup/hold times can be difficult without the proper tools. With Timing Zoom you have access to the industry's most powerful tool for high-speed digital debug.

Features and Applications

Timing Zoom (available in the 16716A, 16717A, 16740A, 16741A, 16742A, 16750A, 16751A and 16752A state/timing modules)

- Simultaneously acquire up to 16K of data at 2 GHz timing and 400 MHz state across all channels, all the time, through the same connection
- Vary the Timing Zoom sample rate from 250 MHz to 2 GHz
- Vary the placement of Timing Zoom data around the trigger point
- Efficiently characterize hardware with 500 ps resolution

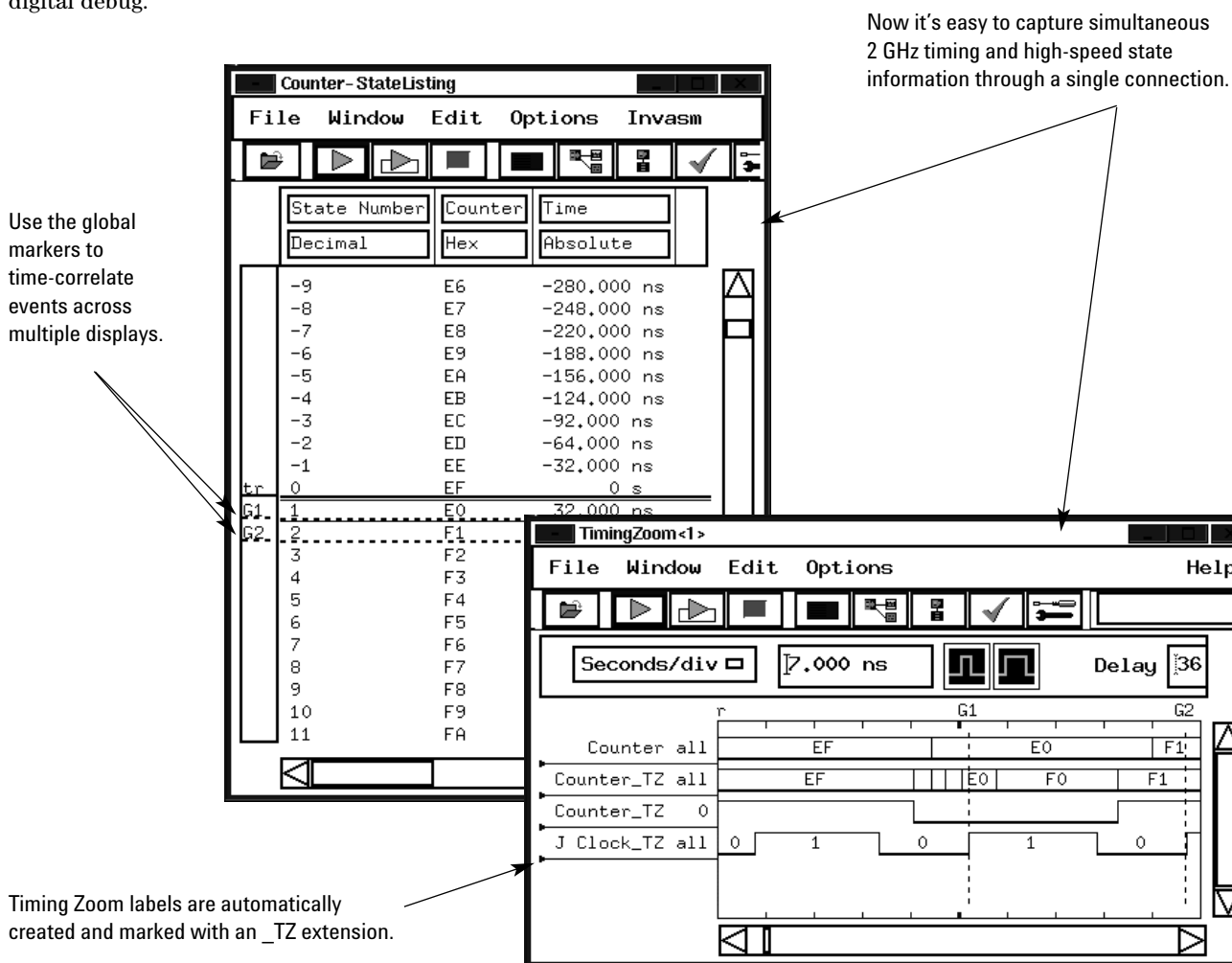

Figure 4.3. Verifying critical edge timing in your system is easy with Agilent Technologies' 2 GHz Timing Zoom technology.

Data Acquisition and Stimulus State/Timing Modules

Eye Finder

Agilent's eye finder examines the signals coming from the circuit under test and automatically adjusts the logic analyzer's setup and hold window on each channel. Eye finder, combined with 100 ps adjustment resolution (10 ps on 16760A) on Agilent's logic analyzer modules, yields the highest confidence in accurate state measurements on high-speed buses.

It takes less than a minute to run eye finder. No special setup or additional equipment is required. You only need to run eye finder once, when the logic analyzer is set up and connected to the target.

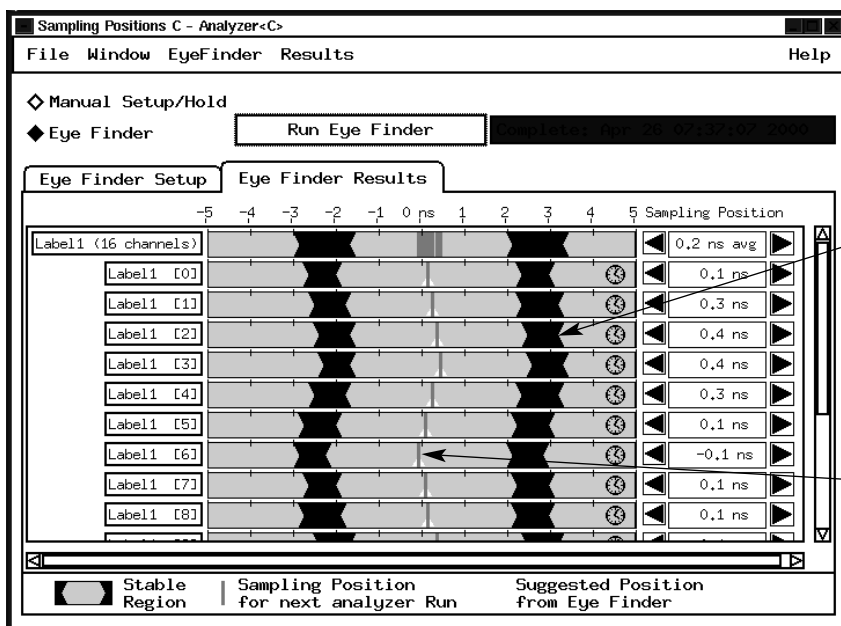

Gray shading indicates regions where transitions are detected.

Blue bars indicate the sampling point selected by eye finder.

Figure 4.4. The eye finder display.

The eye finder display shows:

- Regions of transitions that were discovered on all channels selected
- The sampling point selected by eye finder

Times in the eye finder display are referenced to the incoming clock transitions. The center of the display (labeled "0 ns") corresponds to the clock transitions.

If you want to select a different sample point on any individual channel, just drag and drop the blue "sample" bar at the desired point.

Data Acquisition and Stimulus

State/Timing Modules

Eye Finder as an Analytical Tool

Eye finder is very useful as a first-pass screening test for data valid windows. Because eye finder quickly examines all channels, it is considerably faster than examining each channel with an oscilloscope. After running eye finder, you may want to use an oscilloscope to examine only those signals that are close to your desired specifications for setup and hold.

Eye finder also can quickly provide useful diagnostic or troubleshooting information. If a channel has an unexpectedly small data valid window, or an anomalous offset relative to clock, this could be an indication of a problem, or could be used to validate the cause of an intermittent timing problem.

Differences in the position of the stable region from one signal to another on a bus indicate skew. An indication of excessive skew on eye finder can help isolate which channels you want to check with an oscilloscope, or with the Timing Zoom 2 GHz timing analysis mode in your logic analyzer.

When Do You Need Eye Finder?

Eye finder becomes critical when the data valid window is <2.5 ns. If you're unsure where your clock edge is relative to the data valid window, you can run eye finder for maximum confidence. If the clock in your system runs at 100 MHz or slower, and the clock transitions are approximately centered in the data valid window, you may not see any transition zones indicated in the eye finder display. This is because eye finder only examines a time span of 10 ns (16760A: 6 ns) centered about the clock.

Examples of When to Run Eye Finder

You should use eye finder in the following situations:

Probing a new target, or probing different signals in the same target

- Because eye finder examines the actual signals in the circuit under test, you should run it whenever you probe a different bus or a different target.

Significant change of target temperature

- The propagation delays and signal levels in your target system may vary with temperature. If, for example, you place your target system in a controlled temperature chamber to evaluate its operation over a range of temperatures or to trouble-shoot a problem that only occurs at high or low temperatures, you should run eye finder after the target system stabilizes at the new ambient temperature.

Data Acquisition and Stimulus State/Timing Modules

Features Supported in Agilent State and Timing Analysis Modules

Agilent Module Number	16710A, 16711A, 16712A	16715A	16716A, 16717A, 16740A, 16741A, 16742A, 16750A 16751A, 16752A	16760A
Eye finder		√	√	√
Visittrigger		√	√	√
Timing Zoom			√	
Transitional timing	√	√	√	√
Context Store	√			
Eye Scan				√

Data Acquisition and Stimulus State/Timing Modules

Agilent 16760A: Extending Logic Analysis to New Realms

- Differential inputs (single-ended probes also available).
- State analysis up to 1.5 Gb/s.
- Setup-and-hold time of 500 ps.
- Input signal amplitude as low as 200 mV p-p.

Logic analysis at state speeds up to 1.5 Gb/s imposes a stringent set of criteria for a logic analyzer.

• Probing

Agilent's 16760A uses an innovative probing system with only 1.5 pF of probe tip capacitance, including the connector. The connector is a joint design between Agilent and Samtec, optimized especially for logic analysis measurements.

Ground pins located between every pair of signal pins provide excellent channel-to-channel isolation at high speeds.

• Setup and hold

As state speeds go up, the data valid window shrinks. To make reliable measurements, a logic analyzer's combined setup and hold window must be smaller than the data valid window of the signals it is acquiring. Agilent's 16760A has a combined setup and hold time of 500 ps to match the data valid window of very high-speed buses.

To position the analyzer's setup-and-hold window inside the data valid window requires very fine adjustment resolution. The 16760A gives you the ability to position the setup-and-hold window with 10 ps resolution.

• Small-amplitude signals

Many high-speed designs use small signal amplitudes to limit slew rates and reduce power. Agilent's 16760A can make reliable measurements on signals as small as 200 mV p-p.

• Differential signals

Many high-speed designs use differential signaling to minimize simultaneous switching noise and to provide immunity to crosstalk and noise. The Agilent 16760A has differential inputs to allow you to acquire differential signals with complete confidence. Single-ended probes are also available.

Agilent helps you get started in the design stage.

To probe high-speed signals with a logic analyzer, you need to design the probe in when you are designing your PC board. The following document from Agilent will help you design your system to take maximum advantage of the capabilities of the 16760A logic analyzer:

• Logic signal standards supported

TTL	LVTTL
HSTL Class I & II	HSTL Class III & IV
SSTL2	SSTL3
AGP-2X	LVC MOS 1.5V
LVC MOS 1.8V	LVC MOS 2.5V
LVC MOS 3.3V	CMOS 5V
ECL	LVPECL
PECL	
User defined from -3V to +5V in 10mV increments	

Publication Title	Description	Publication Number
User's Guide, Agilent Technologies E5378A, E5379A, and E5380A Probes for the 16760A Logic Analyzer	Mechanical drawings, electrical models, general information on probes for the 16760A	16760-97007
Designing High-Speed Digital Systems for Logic Analyzer Probing	Guidelines and design examples for designing logic analyzers probing into your target system	5988-2989EN

Data Acquisition and Stimulus State/Timing Modules

Eye scan

In the eye scan mode, the Agilent 16760A scans all incoming signals for activity in a time range centered on the clock and over the entire voltage range of the signal. The results are displayed in a graph similar to an eye diagram as seen on an oscilloscope.

As timing and voltage margins continue to shrink, confidence in signal integrity becomes an increasingly vital requirement of the design verification process. Eye scan lets you acquire comprehensive signal integrity information on all the buses in your design, under a wide variety of operating conditions, in minimum time.

Qualified eye scan

In the qualified eye scan mode, a single qualifier input defines what clock cycles are to be acquired and what cycles are to be ignored in the eye scan acquisition. For example, you may wish to examine the eye diagram for read cycles only, ignoring write cycles.

Cursors

Two manually positioned cursors are available. The readout indicates the time and voltage coordinates of each cursor.

Eye limit

The eye limit tool is a single point cursor that can be positioned manually. The readout indicates the inner eye limits detected at the time and voltage coordinates of the cursor.

Histogram

The histogram tool indicates the relative number of transitions along a selected line. The time range and voltage levels of the histogram are selected by manually positioning a pair of cursors. The cursors indicate the voltage level and the beginning and end times of the histogram.

Polygon

A 4-point or 6-point polygon can be defined manually.

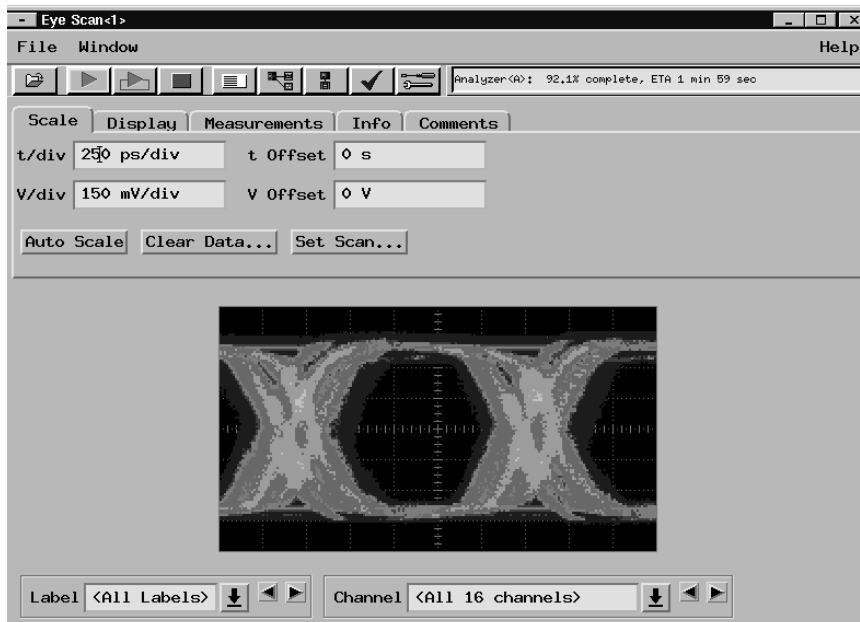

Slope

The slope tool indicates DV/DT between two manually - positions cursors.

Eye scan allows the user to set the following variables:

- The number of clock cycles to be evaluated at each time and voltage region
- The display mode
 - Color graded
 - Intensity shaded
 - Solid color
- Aspect ratio of the display
- Time/division
- Time offset
- Volts/division
- Voltage offset
- Time resolution of measurement
- Voltage resolution of measurement

Results can be viewed for each individual channel. A composite display of multiple channels and/or multiple labels is also available. Individual channels can be highlighted in the composite view

Eye scan data can be stored and recalled for later comparison or analysis.

Data Acquisition and Stimulus State/Timing Modules

Probing solutions to match the measurement capabilities

Three probing options are available for the Agilent 16760A. Each probe can be ordered by its individual model number or as an option to the 16760A. The following table indicates both the model number and the option number.

Probes are not supplied as part of the standard 16760A. Probes must be ordered separately, either as options to the 16760A or individually by their respective model numbers.

Agilent Model Number	16760A Option Number	Description	Notes
E5378A	010	100-pin single-ended probe	Requires a kit of mating connectors and shrouds (see the next table) to connect to target system.
E5379A	011	100-pin differential probe	Two E5379A (or two option 011 on the 16760A) are required to support all 34 channels on a 16760A. Requires a kit of mating connectors and shrouds (see the next table) to connect to target system.
E5380A	012	38-pin single-ended probe, compatible with target systems designed for the Agilent E5346A Mictor adapter cable	Maximum state analysis speed is 600 Mb/s. Minimum input amplitude is 300 mV p-p. Requires a kit of mating connectors and shrouds (see the next table) to connect to target system.
E5382A	013	17-channel, single-ended flying lead probe set for the 16760A	Two E5382A are required to support all the channels of a 16760A.

Connector and shroud kits for probes for the 16760A logic analyzer

For probe model number	For PC board thickness	Probing connector kit part number (each contains 5 mating connectors and 5 support shrouds)
E5378A	Up to 1.57 mm (0.062") Up to 3.05 mm (0.120")	16760-68702 16760-68703
E5379A	Up to 1.57 mm (0.062") Up to 3.05 mm (0.120")	16760-68702 16760-68703
E5380A	Up to 1.57 mm (0.062") Up to 3.18 mm (0.125")	E5346-68701 E5346-68700

Data Acquisition and Stimulus

Oscilloscope Modules

When integrated into the 16700 Series logic analysis systems, the oscilloscope modules make powerful measurement and analysis more accessible, so you can find the answers to tough debugging problems in less time. Oscilloscope controls are easy to find and use.

Multiple Views of Target Behavior Isolate Problems Quicker

Frequently a problem is detected in one measurement domain, while the clues to the cause of the problem are found in another. That's why the ability to view your prototype's behavior from all angles simultaneously—from software execution to analog signals—is essential for quickly gaining insight into problems.

For example, using a state analyzer you may observe a failed bus cycle. A timing problem caused by a reflection on an incorrectly terminated line may be causing the bus cycle to fail. By triggering an oscilloscope from the state analyzer, you can quickly identify the cause. The ability to cross-trigger and time-correlate state, timing, and analog measurements can help you in solving these tough problems.

Scope controls and waveform display are integrated into a single window, making interactive adjustment easy.

Time and voltage markers allow you to measure signal details precisely.

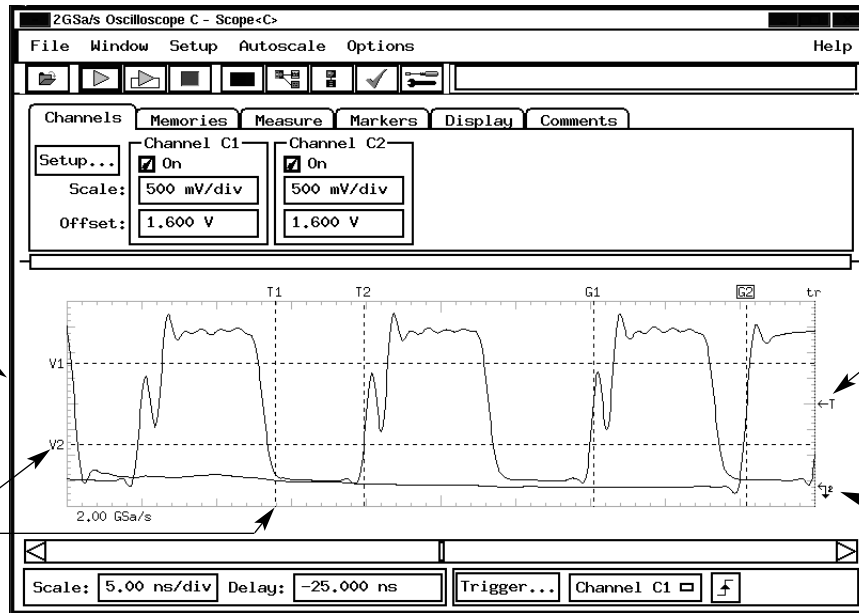

Trigger icon indicates trigger level, making it easy for you to adjust trigger level.

Ground icon always shows you where ground is relative to signal.

Figure 4.5. All primary oscilloscope control settings, including scale factors and trigger settings, are visible simultaneously.

Data Acquisition and Stimulus Oscilloscope Modules

Automatic Measurements Quickly Characterize Signals

The Agilent Technologies 16534A oscilloscope modules quickly characterize signals with automatic measurements of rise time, voltage, pulse width, and frequency.

Markers Easily Set Up Timing and Voltage Margin Measurements

Four independent voltage markers and two local time markers are available to quickly set up measurements of voltage and timing margins.

The global time markers of the 16700 Series logic analysis systems let you correlate state, timing, and oscilloscope measurements to track problems across multiple measurement domains.

Automatic measurements save time in characterizing signal parameters.

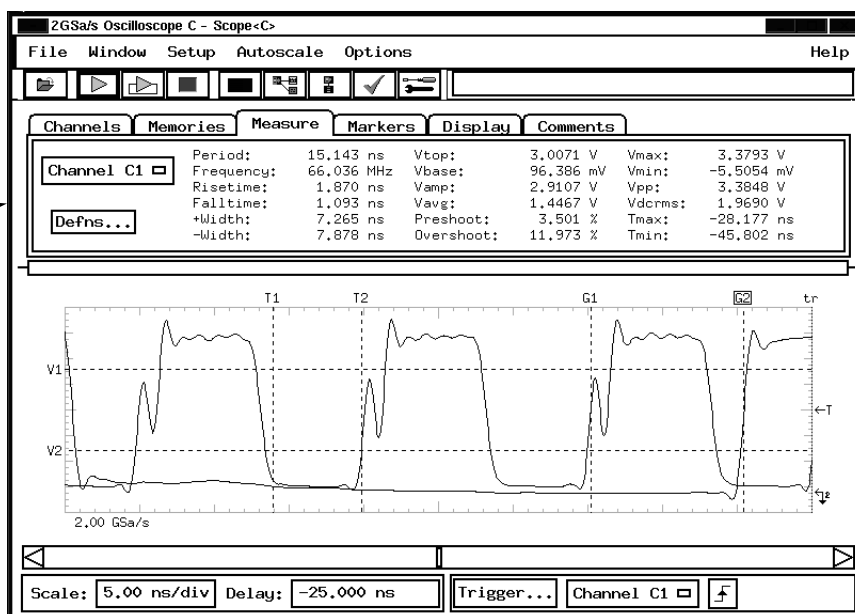

Figure 4.6. Automatic measurements and markers let you make faster analysis.

Data Acquisition and Stimulus Oscilloscope Modules

More Channels When You Need Them

You can combine up to four 16534A oscilloscope modules to provide up to eight channels on a single time base. When you operate in this mode, you can use the master module for triggering.

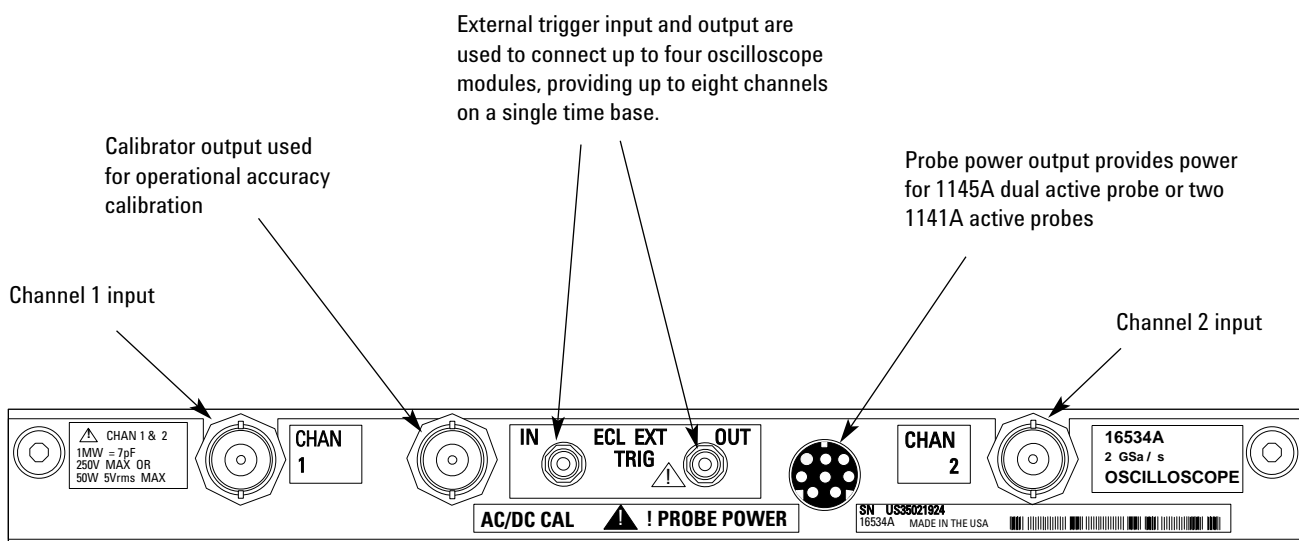

Figure 4.7. Connector panel of the 16534A oscilloscope module.

Data Acquisition and Stimulus Pattern Generation Modules

Digital Stimulus and Response in a Single Instrument

Configure the logic analysis system to provide both stimulus and response in a single instrument. For example, the pattern generator can simulate a circuit initialization sequence and then signal the state or timing analyzer to begin measurements. Use the compare mode on the state analyzer to determine if the circuit or subsystem is functioning as expected. An oscilloscope module can help locate the source of timing problems or troubleshoot signal problems due to noise, ringing, overshoot, crosstalk, or simultaneous switching.

Parallel Testing of Subsystems Reduces Time to Market

By testing system subcomponents before they are complete, you can fix problems earlier in the development process. Use the Agilent 16720A as a substitute for missing boards, integrated circuits (ICs), or buses instead of waiting for the missing pieces. Software engineers can create infrequently encountered test conditions and verify that their code works—before complete hardware is available. Hardware engineers can generate the patterns necessary to put their circuit in the desired state, operate the circuit at full speed or step the circuit through a series of states.

Key Characteristics

Agilent Model 16720A

Maximum clock (full/half channel)	180/300 MHz
Number of data channels (full/half channel)	48/24 Channels
Memory depth (full/half channels)	8/16 MVectors
Maximum vector width (5 module system, full/half channel)	240/120 Bits
Logic levels supported	TTL, 3-state TTL, 3.3V, 1.8V, 3-state CMOS, ECL, 5V PECL, 3.3V LVPECL, LVDS
Maximum binary vector set size	16 MVectors (24 channels)
Editable ASCII vector set size	1 MVectors

Data Acquisition and Stimulus Pattern Generation Modules

Vectors Up To 240 Bits Wide

Vectors are defined as a "row" of labeled data values, with each data value from one to 32 bits wide. Each vector is output on the rising edge of the clock.

Up to five, 48-channel 16720A modules can be interconnected within a 16700 Series mainframe or expansion frame. This configuration supports vectors of any width up to 240 bits with excellent channel-to-channel skew characteristics (see specific data pod characteristics in Pattern Generation Modules Specifications starting on page 105). The modules operate as one time-base with one master clock pod. Multiple modules also can be configured to operate independently with individual clocks controlling each module.

Depth Up to 16 MVectors

With the 16720A pattern generator, you can load and run up to 16 MVectors of stimulus. Depth on this scale is most useful when coupled with powerful stimulus generated by electronic design automation tools, such as SynaptiCAD's WaveFormer and VeriLogger. These tools create stimulus using a combination of graphically drawn signals, timing parameters that constrain edges, clock signals, and temporal and Boolean equations for describing complex signal behavior. The stimulus also can be created from design simulation waveforms. To take advantage of the full depth of the 16720A pattern generator, data must be loaded into the module in the Pattern Generator Binary (.PGB) format. The SynaptiCAD tools allow you to convert .VCD files into .PGB files directly, offering you an integrated solution that saves you time.

Synchronized Clock Output

You can output data synchronized to either an internal or external clock. The external clock is input via a clock pod, and has no minimum frequency (other than a 2 ns minimum high time).

The internal clock is selectable between 1 MHz and 300 MHz in 1 MHz steps. A Clock Out signal is available from the clock pod and can be used as an edge strobe with a variable delay of up to 8 ns.

Initialize (INIT) Block for Repetitive Runs

When running repetitively, the vectors in the initialize (init) sequence are output only once, while the main sequence is output as a continually repeating sequence. This "init" sequence is very useful when the circuit or subsystem needs to be initialized. The repetitive run capability is especially helpful when operating the stimulus module independent of the other modules in the logic analysis system.

"Signal IMB" Coordinates System Module Activity

A "Signal IMB" (intermodule bus) instruction acts as a trigger arming event for other logic analysis modules to begin measurements. IMB setup and trigger setup of the other logic analysis modules determine the action initiated by "Signal IMB".

"Wait" for Input Pattern

The clock pod also accepts a 3-bit input pattern. These inputs are level-sensed so that any number of "Wait" instructions can be inserted into a stimulus program. Up to four pattern conditions can be defined from the OR-ing of the eight possible 3-bit input patterns. A "Wait" also can be defined to wait for an intermodule bus event. This intermodule bus event signal can come from any other module in the logic analysis system.

Data Acquisition and Stimulus Pattern Generation Modules

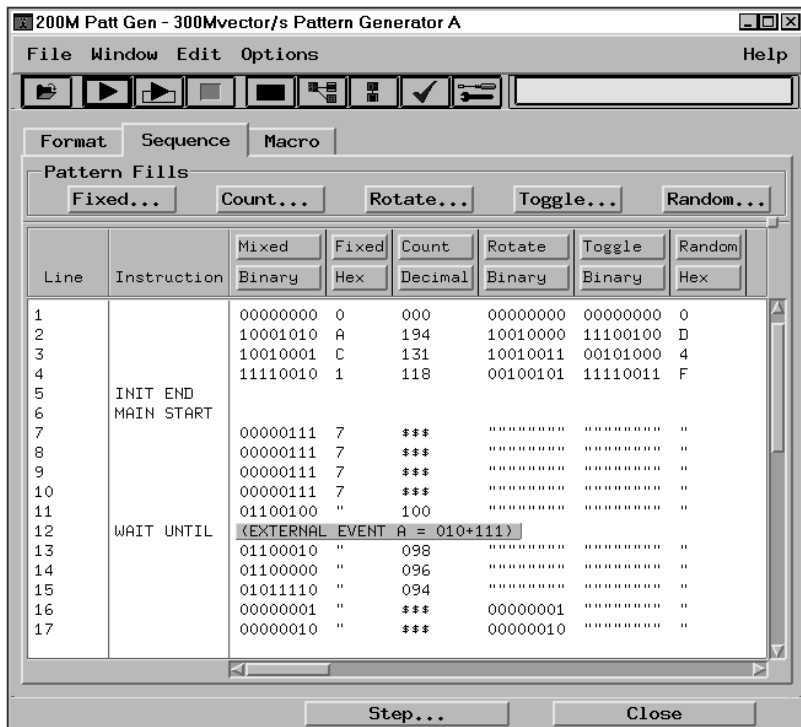

Figure 4.8. Stimulus vectors are defined in the Sequence menu tab. In this example, vector output halts until the WAIT UNTIL condition is satisfied.

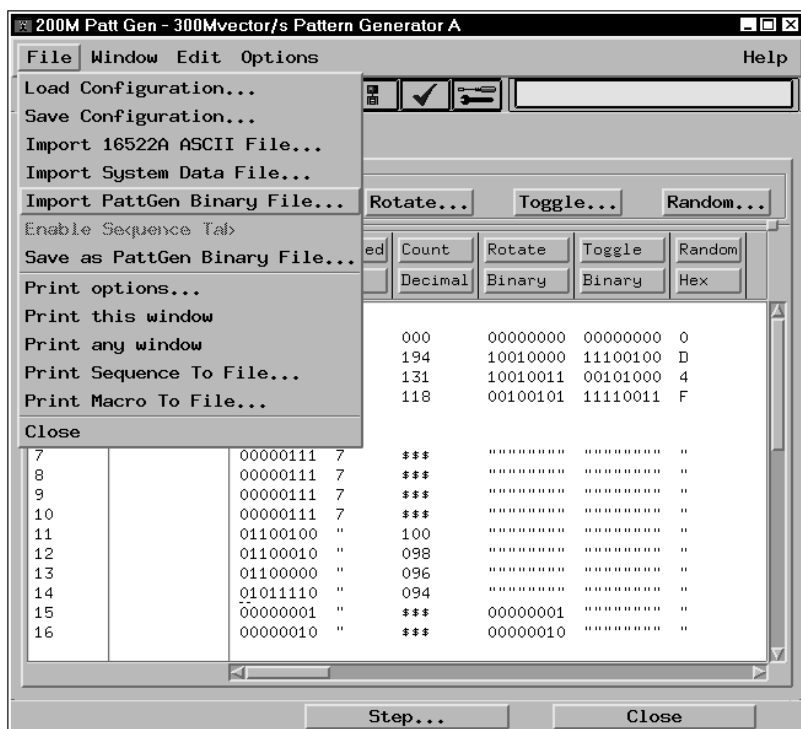

Figure 4.9. To fill the 16720A pattern generator's 8 MVector deep memory (16 MVector in half channel mode) with data, the stimulus must be in 'pattern generator binary' format. Stimulus files in .PGB format can be loaded directly from the user interface.

Data Acquisition and Stimulus Pattern Generation Modules

"User Macro" and "Loop" Simplify Creation of Stimulus Programs

User macros permit you to define a pattern sequence once, then insert the macro by name wherever it is needed. Passing parameters to the macro will allow you to create a more generic macro. For each call to the macro you can specify unique values for the parameters. Each macro can have up to 10 parameters. Up to 100 different macros can be defined for use in a single stimulus program.

Loops enable you to repeat a defined block of vectors for a specified number of times. The repeat counter can be any value from 1 to 20,000. Loops and macros can be nested, except that a macro can not be nested within another macro. When nested, each invocation of a loop or a macro is counted towards the 1,000 invocation limit. At compile time, loops and macros are expanded in memory to a linear sequence.

Convenient Data Entry and Editing Feature

You can conveniently enter patterns in hex, octal, binary, decimal, and two's complement bases. The data associated with an individual label can be viewed with multiple radices to simplify data entry. Delete, Insert, Copy, and Merge commands are provided for easy editing. Fast and convenient Pattern Fills give the programmer useful test patterns with a few key strokes. Fixed, Count, Rotate, Toggle, and Random are available to quickly create a test pattern, such as "walking ones". Pattern parameters, such as Step Size and Repeat Frequency, can be specified in the pattern setup.

ASCII Input File Format: Your Design Tool Connection

The 16720A supports an ASCII file format to facilitate connectivity to other tools in your design environment. Because the ASCII format does not support the instructions listed earlier, they cannot be edited into the ASCII file. User macros and loops also are not supported, so the vectors need to be fully expanded in the ASCII file. Many design tools will generate ASCII files and output the vectors in this linear sequence. Data must be in Hex format, and each label must represent a set of contiguous output channels. Data in this ASCII format is limited to 1 MVectors in the 16720A.

Configuration

The 16720A pattern generators require a single slot in a logic analysis system frame. The pattern generator operates with the clock pods, data pods, and lead sets described later in this section. At least one clock pod and one data pod must be selected to configure a functional system. Users can select from a variety of pods to provide the signal source needed for their logic devices. The data pods, clock pods and data cables use standard connectors. The electrical characteristics of the data cables also are described for users with specialized applications who want to avoid the use of a data pod. The 16720A can be configured in systems with up to five cards for a total of 240 channels of stimulus.

Direct Connection to Your Target System

The pattern generator pods can be directly connected to a standard connector on your target system. Use a 3M brand #2520 Series, or similar connector. The 16720A clock or data pods will plug right in. Short, flat cable jumpers can be used if the clearance around the connector is limited. Use a 3M #3365/20, or equivalent, ribbon cable; a 3M #4620 Series, or equivalent, connector on the 16720A pod end of the cable; and a 3M #3421 Series, or equivalent, connector at your target system end of the cable.

Probing Accessories

The probe tips of the Agilent 10474A, 10347A, and 10498A lead sets plug directly into any 0.1 inch grid with 0.026 inch to 0.033 inch diameter round pins or 0.025 inch square pins. These probe tips work with the Agilent 5090-4356 surface mount grabbers and with the Agilent 5959-0288 through-hole grabbers. Other compatible probing accessories are listed in ordering information on page 121.

Data Acquisition and Stimulus Emulation Modules

Speed Problem Solving With Off-the-Shelf Solutions for Many Common Microprocessors

To help you design and debug your microprocessor-based target systems, Agilent offers different microprocessor specific products that let you get control and visibility over your microprocessor's internal and external data.

An analysis probe allows you to quickly connect an Agilent logic analyzer to your target system. The analysis probe provides non-intrusive capture and disassembly of microprocessor and bus activity

Analysis probes are available for over 200 microprocessors and microcontrollers. Bus probes allow probing of popular bus architectures such as PCI, AGP, USB, VXI, SCSI, and many others.

Flexible physical probing schemes give quick and reliable connections to almost any device on your prototype.

On-Chip Emulation Tools Make Fixing Bugs Easier

For specific microprocessor families that feature on-chip emulation, you can add a processor emulation module to your system to connect the on-board debugging resources of the microprocessor to the logic analysis system.

The microprocessor's BDM or JTAG technology provides control over processor operation even if there is no software monitor on the target system. This feature is particularly helpful during the development of your target system's boot code.

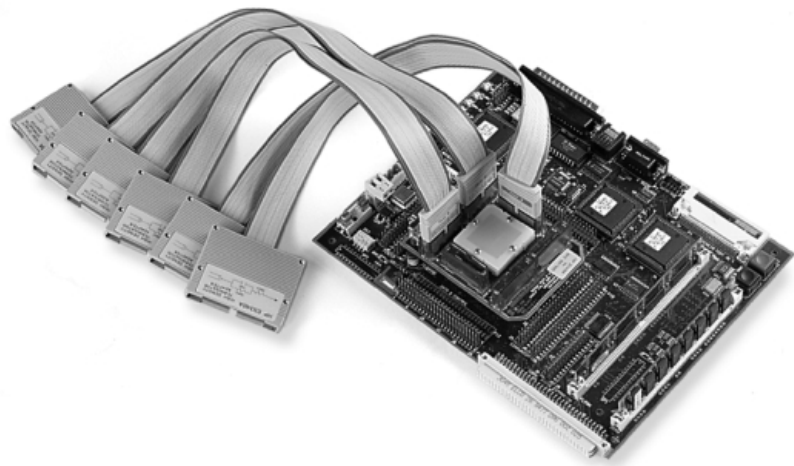

Figure 4.10. Agilent analysis probes make it easy to connect a logic analyzer to your target system.

Data Acquisition and Stimulus Emulation Modules

Emulation Control Interface

The emulation control interface is accessed from the power up screen of the Agilent 16700 Series system. The interface is included with the Agilent E5901A/B emulation modules.

Designed for hardware engineers, this graphical user interface provides the following features:

- Control over processor execution: run/break/reset/step.
- Register display/modification.
- Memory display/modification in various formats including disassembly for code visualization. Memory modification or memory block fill can be done to check processor memory access or to reinitialize memory areas.
- Multiple breakpoint configuration: hardware, software, and processor internal breakpoint registers.
- Code download to the target.
- Command scripts to reproduce test sequences.
- The ability to trigger a measurement module on a processor break or to receive a trigger from the logic analysis system's measurement modules.

Integrated Debugger Support

When the hardware turn-on phase is completed, the same Agilent emulation module can be connected to high-level debuggers for C or C++ software development.

You can achieve the functionality of a full-featured emulator by using a third-party debugger to drive the installed Agilent emulation module. This gives you complete microprocessor execution control (run control).

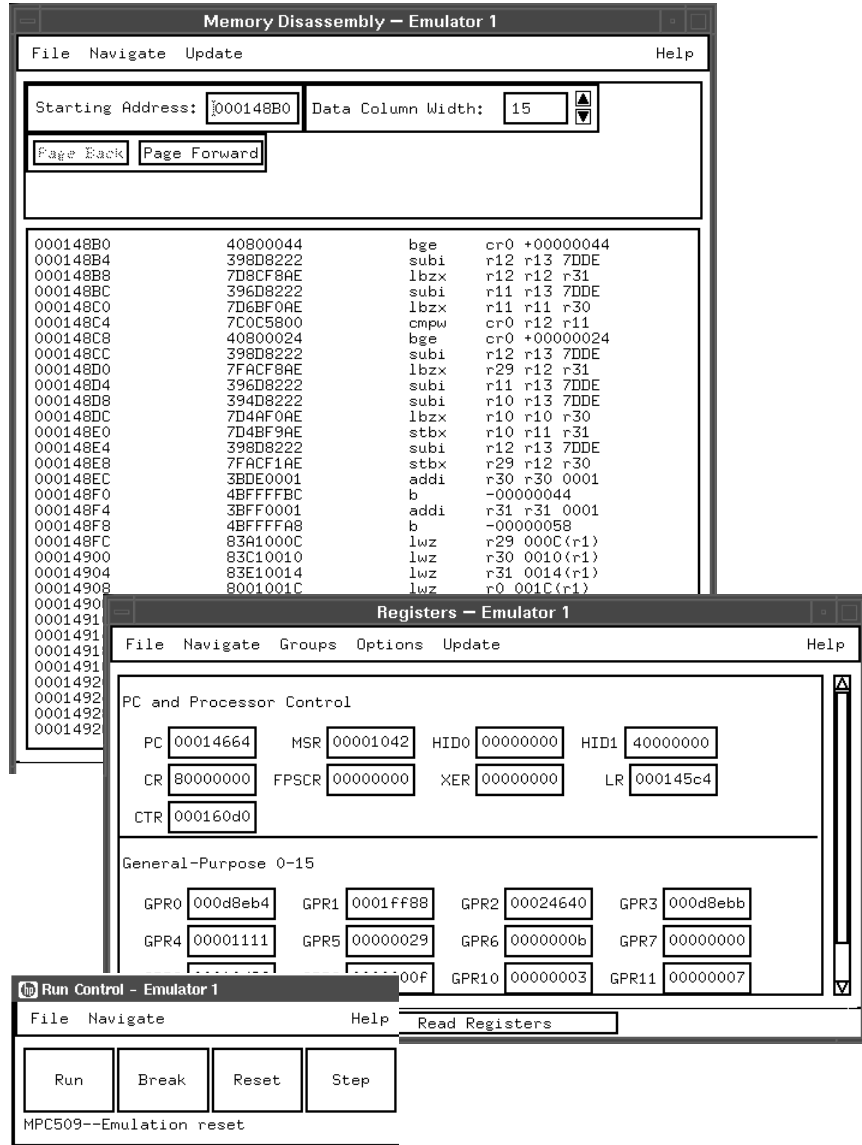

Figure 4.11. Emulation control interface.

Post-Processing and Analysis Tool Sets

Software Tool Sets

Once the data is acquired, you can rely on the post-processing tools to rapidly consolidate data into displays that provide insight into your system's behavior. The tool sets described in the following pages are optional, post-processing software packages for the 16700 Series logic analysis systems.

Selecting the Right Tool Set

Take a look at the tool set descriptions below to see if they meet your needs. If you don't immediately see what you need there is also the option of writing your own analysis application using the tool development kit. Best of all, you can try out any one of these tool sets with no obligation to buy.

Application	Product Name	Model Number	Detailed Information
<p>Debug your real-time code at the source level Correlate a logic analyzer trace with the high-level source code that produced it. Set up the logic analyzer trace by simply pointing and clicking on a line of source code.</p>	Source Correlation Tool Set	B4620B	Page 40
<p>Debug your parallel data communication buses Display logic analyzer trace information at a protocol level. Powerful trigger macros allow triggering on standard or custom protocol fields. Data bus width is limited only by the number of available channels.</p>	Data Communications Tool Set	B4640B	Page 44
<p>Optimize your target system's performance Profile your target system's performance to identify system bottlenecks and to identify areas needing optimization.</p>	System Performance Analysis Tool Set	B4600B	Page 53
<p>Solve your serial communication problems Convert serial bit streams to parallel format for easy viewing and analysis. Supports serial data with or without an external clock reference and protocols that use bit stuffing to maintain clock synchronization. Works at speeds up to 1 GHz.</p>	Serial Analysis Tool Set	B4601B	Page 60
<p>Customize your trace for greater insight Create custom tools using the C programming language. Custom tools can analyze captured data and present it in a form that makes sense to you. Analysis systems do not require the tool development kit to run generated tools.</p>	Tool Development Kit	B4605B	Page 66

Post-Processing and Analysis Tool Sets

Software Tool Sets

Free Tool Set Evaluation

To see which tool sets best fit your needs, Agilent Technologies offers a free 21-day trial period that lets you evaluate any tool set as your work schedule permits. Once you receive your tool, you obtain a password that temporarily enables the tool.

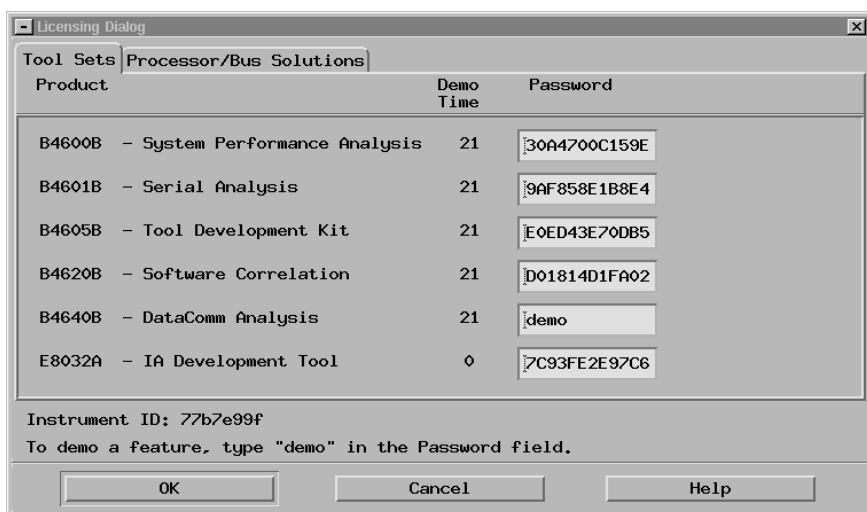

Figure 5.1. For a free, one-time, 21-day trial of any tool set, simply type "demo" in the password field for the product you want to evaluate.

Post-Processing and Analysis Tool Sets

Source Correlation

Debug Your Source Code

The Agilent B4620B source correlation tool set correlates a microprocessor execution trace window with a corresponding high-level source code window. The source correlation tool set enhances your software development environment by providing multiple views of code execution and variable content under severe real-time constraints.

Using the B4620B you can obtain answers to many of your questions concerning software code execution, data tracking, and software-hardware integration.

Obtain Answers to the Following Questions:

Software Code Execution

- What happened just before the target system crashed?
- What source code was executed at a specific point in time?

- What is the exact time between two user-defined system events?
- What is the execution history leading up to or occurring after an area of interest?

Data Tracking

- What is the exact history of a variable's value over time?
- Which routine(s) corrupted the data?

Software-Hardware Integration

- What is the root cause of a system failure—hardware or software?
- Are timing anomalies found by the hardware engineer the cause of software problems?
- Is the software engineer working on the same problem as the hardware engineer?
- What portion of the source code correlates to the problem the hardware engineer reported?

Product Description

The tool set's main advantage is its ability to allow you to observe software execution without halting the system or adding instructions to the code. The tool set uses information provided in your compiler's object file to build a database of source files, line numbers and symbol information to reference to logic analyzer traces. The tool set can also be used to set up the logic analyzer trace by simply pointing and clicking on a source line.

Once the tool set is enabled on your 16700 Series system, you can support new processors by changing analysis probes and verifying object file compatibility. Multiple-processor systems are also supported.

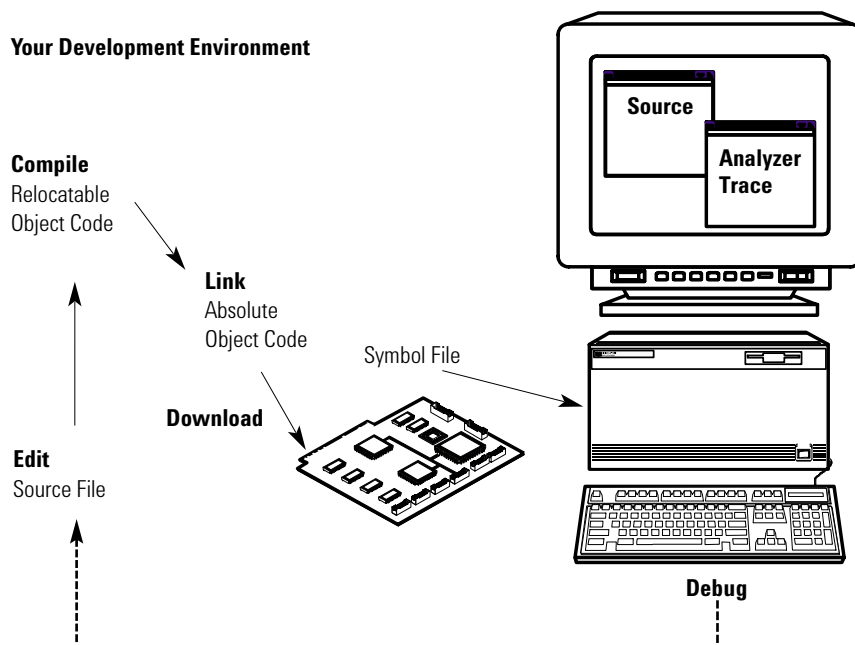

Figure 5.2. The source correlation tool set allows you to observe software execution without halting the system or adding instructions to the code.

Post-Processing and Analysis Tool Sets

Source Correlation

When You Want to Trace . . .

...on a variable to see what caused data corruption.

...on a function to determine where it is being called from in order to understand the context of a system error.

...on a line number to determine if a specific code segment is ever executed.



```

139
140 main()
141 {
142     boot_q();
143
144     init_system();
145     proc_spec_init();
146
147     for (;;)
148     {
149         update_system(num_checks);
150         num_checks++;
151         update_display(num_checks);
152         proc_specific();
153     }
154 }
155
156 /******
157 * FUNCTION: update_display
158 * PARAMS: counter -- loop counter passed in from main
159 * DESCRIPTION:
160 * clear out the history buffer and update the current ascii display
161 * of operating data (ascii_old_data).
162 *
163 *****/
164 void
165 update_display(int counter)
166 {
167
168     ME_update_display = 1;
169
170     if ( ! ( (counter > X32) ) )
171     {
172         /* Clear out the control history buffer */
173         clear_hist_buff();
174     }
175
176     if ( counter & X32 == rand() & X32 )
177     {
178         /* Display Output variables in clear text as well as
179          controlling and controlled variables */
180         if (func_needed & HEART)
181         {
182             strncpy( ascii_old_data[0], "HEART", 16);
183         }
184         else
185         {

```

Simply Click . . .

... to trace about a variable, function, or line number.

... to halt processor execution with an integrated emulation module when the trace event occurs.

...to use text search to quickly navigate through hundreds of symbols. To recall previous entries when rotating through debug tests.

...to specify alignment conditions for processors that don't include lower address bits on the bus. This is necessary if your processor uses bursting or byte enables when fetching instructions.

...to use address offsets for code that is dynamically loaded or moved from ROM to RAM during a boot-up sequence.

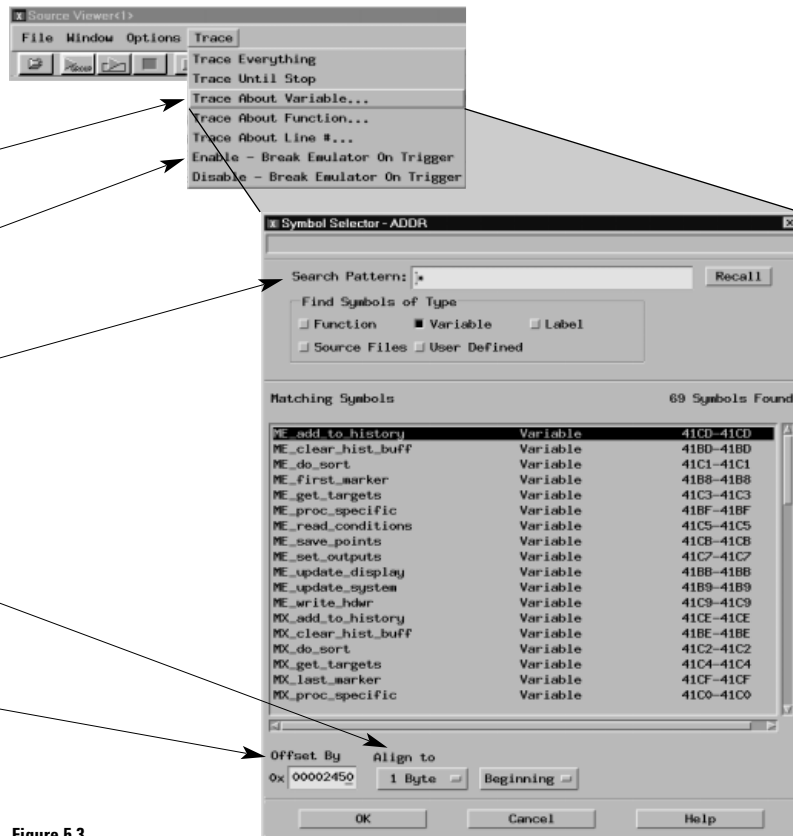

Figure 5.3.

Post-Processing and Analysis Tool Sets

Source Correlation

Once You Acquire the Trace . . .

...“step” through the trace at the source-code level or the assembly level. Locate the cause of a problem by “stepping backward” from the point where you see a problem to its root cause.

...quickly locate a specific function, variable, or text string. The system maintains a history of previous text searches for quick recall.

...click the source line which you want to trace about on your next acquisition.

...set the data type to “Symbols” to view file name and line number.

...filter out unexecuted code fetches from the inverse assembled trace to view executed code only, using Agilent’s advanced inverse assembly filtering for popular processors.

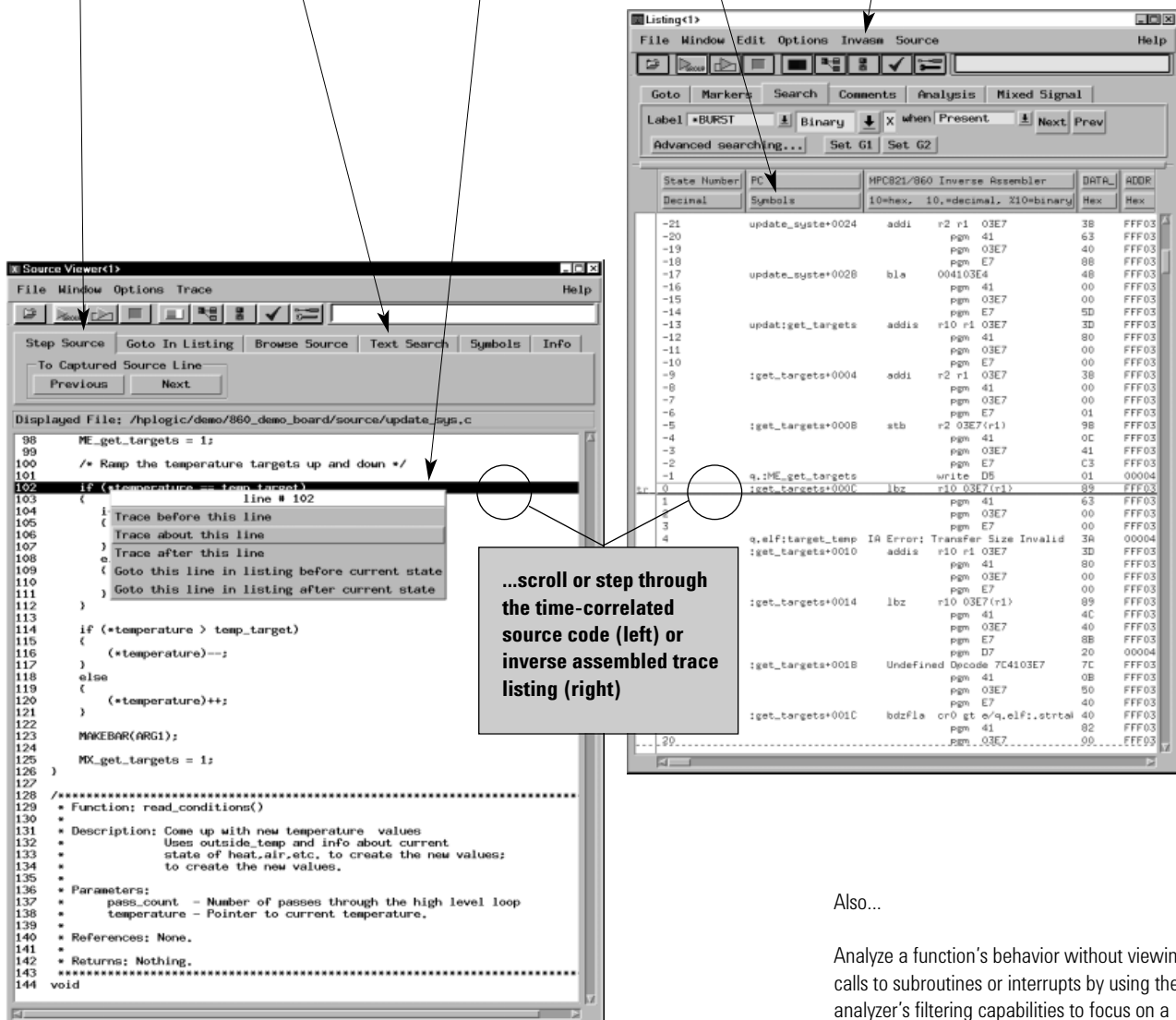

...scroll or step through the time-correlated source code (left) or inverse assembled trace listing (right)

Also... Analyze a function’s behavior without viewing calls to subroutines or interrupts by using the analyzer’s filtering capabilities to focus on a specific part of the executed software.

Figure 5.4.

Post-Processing and Analysis Tool Sets

Source Correlation

Product Characteristics

Data Sources

All state and timing measurement modules supported by the 16700 Series logic analysis systems (except the 16517A/518A) serve as data sources for the source correlation tool set.

Microprocessor Support

The source correlation tool set supports many of the most popular embedded microprocessors. Non-intrusive analysis probes for the 16700 Series systems provide reliable, fast and convenient connections to your target system.

New microprocessors are constantly being added to the list of supported CPUs. For the most current information about supported microprocessors, please contact your Agilent Technologies sales representative or visit our web site: http://www.agilent.com/find/logic_analyzer.

Object File Format Compatibility

The 16700 Series logic analysis systems quickly and reliably read your specific object file format. Agilent Technologies' extensive experience with different file formats and symbol representations ensures that your source code files are accurately correlated and your system is precisely characterized.

Source correlation and system performance measurements do not require any change in your software generation process. No modification or recompilation of your source code is required.

You can load multiple object files. Address offsets are also supported, enabling system performance measurements and source-code level views of dynamically loaded software execution or code moved from ROM to RAM during a boot-up sequence.

High-level language tools that produce the following file formats are supported:

- Agilent(HP)/MRI IEEE696
- ELF/DWARF*
- ELF/Stabs*
- TI_COFF
- COFF/Stabs*
- Intel OMF86
- Intel OMF96
- Intel OMF 286
- Intel OMF 386 (which supports Intel80486 and Pentium Language)

*Supports C++ name de-mangling

If your language system does not generate output in one of the listed formats, a generic ASCII file format is also supported.

For the most current information about supported compiler file formats and processor support, please contact your Agilent Technologies sales representative.

Source File Access

The source correlation tool set must be able to access source files to provide source line referencing. Source files can reside in multiple directories on the hard drive of your workstation, PC, or on the 16700 Series mainframe's internal hard disk. You can access the files via NFS-mounted disks or CIFS mounted disks. To display the source file, the tool set first looks for the source path name in the object file, follows the path to access the source file and, if not found, looks for the source file in alternate user-defined directories.

The 16700 Series logic analysis systems automatically place the following in the directory search path:

- NFS mounted directories
- Directory paths specified in loaded symbol files
- Directory paths specified in loaded source files

Source Correlation Functionality

- Source code and inverse assembled trace listing are time-correlated.
- User can alternate between source viewer and browsing of other source files.
- Trace specification can be set up from the source viewer or file browser.
- For multiple-processor systems, each trace window can be time-correlated to a source viewer.

Post-Processing and Analysis Tool Sets

Data Communications

Monitor Packet Information on Parallel Data Buses

The data communications tool set shows parallel bus data at a protocol level on the logic analyzer. Developers have the capability to find complex, system-level bus interaction problems in applications such as a switching or routing system.

Obtain Answers to the Following Questions:

- What is the time difference between two or more data paths and/or a microprocessor?
- Did a packet make it through the switch or router?
- Why did a packet take so long to go through the switch or router?
- Where did an illegal packet come from?
- What is the latency on packet information?
- What is corrupting packets?

Product Description

The Agilent Technologies B4640B data communications tool set adds protocol analysis capabilities to the logic analyzer for viewing parallel data buses (e.g, UTOPIA or a proprietary data bus) in a switching or routing system. Each protocol layer is displayed with a different color in the logic analyzer lister display to allow easy viewing of the protocol data. Payload information is included after the header in a raw hex format. Filters are included to allow many different views of the data. Protocol layers can be collapsed or expanded to create a custom view of the data acquired in the logic analyzer. With the filters, you can concentrate on the data of interest for a particular measurement.

The powerful protocol trigger macro allows easy trigger setup by eliminating the need to manually configure the trigger sequencer for complex measurements. All custom-defined protocol fields or layers are supported in the trigger macro.

All packets or cells are time-stamped in the logic analyzer for time-correlation measurements with other system buses, such as a microprocessor, memory interface, PCI bus, or other UTOPIA bus. All state listing and waveform displays in the logic analyzer are time-correlated with global markers for a complete view of the system. With this tool, it is possible to trigger the logic analyzer with a microprocessor event and see what is happening on a parallel data bus with protocol information.

By monitoring multiple time-correlated data buses, you can monitor a packet entering one ASIC and see how long it takes for the packet to reach another part of the system. The powerful trigger can also monitor a packet entering one port and trigger if the packet has not reached another port by a designated time.

Post-Processing and Analysis Tool Sets

Data Communications

Theory of Operation

Use a logic analyzer to probe the system's parallel data buses (e.g., UTOPIA).

The analyzer needs access to:

- Data signals
- Qualifying signals
- Start of cell or packet bit
- Synchronous clock for the bus

The synchronous bus clock samples data into the logic analyzer. Qualifiers such as "Data Valid" allow the logic analyzer to sample only on events of interest instead of all cycles.

With access to the "Start of Cell" or "Start of Packet" bit on the data bus, the analyzer starts looking at the beginning of a cell or packet. With the protocol definition set up by the user, the logic analyzer can sequence down into the cell or packet to find the desired protocol field to trigger on.

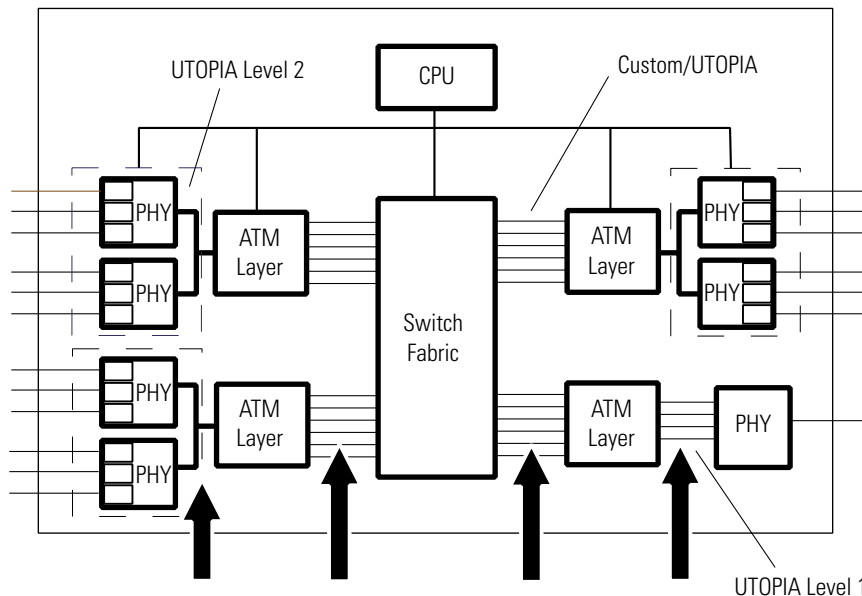

Figure 5.5. Typical ATM Switch Design.

Post-Processing and Analysis Tool Sets

Data Communications

Product Characteristics	Additional Information	
Requires	16700 Series logic analysis system with system software version A.01.50.00 or higher	
Applications	Trigger on a processor event and see what is happening on a parallel data bus with protocol information or vice versa.	
Supported Measurement Modules	16715A, 16716A, 16717A, 16718A, 16719A, 16750A, 16751A, 16752A	
Protocols Supported	<ul style="list-style-type: none"> • Ethernet • ATM • TCP/IP Stack • Custom 	<ul style="list-style-type: none"> • Example files for these protocols are provided with the product. These standard files can be edited to include any custom protocol "wrapper" layers or fields. • Custom protocols are supported by entering the protocol setup information via the logic analyzer interface or a text file. Custom protocol definitions are used in both the trigger definition and packet display.
Trigger Macro	All custom-defined protocol fields or layers are supported in the trigger macro	
Maximum Parallel Bus Width	Limited only by the number of available channels	
Display Features	<ul style="list-style-type: none"> • Color • Filters and preferences • Payload information • Protocol layers 	<ul style="list-style-type: none"> • Each protocol layer is displayed with a different color in the analyzer's lister display to allow easy viewing of protocol data. • Specific protocol layers and fields can be selected for viewing in the trace. Provides many different views of the data. Allows you to concentrate on the data of interest for a particular measurement. • Included after the header in a raw hex format • Can be collapsed or expanded to create a custom view of the acquired data

Post-Processing and Analysis Tool Sets

Data Communications

Edit or create a protocol using the logic analyzer user interface.

Select a known protocol and add proprietary fields.

Insert custom wrapper or field here.

Insert name, number of bits and format for trigger and display.

Define any symbols for both trigger and display of packets.

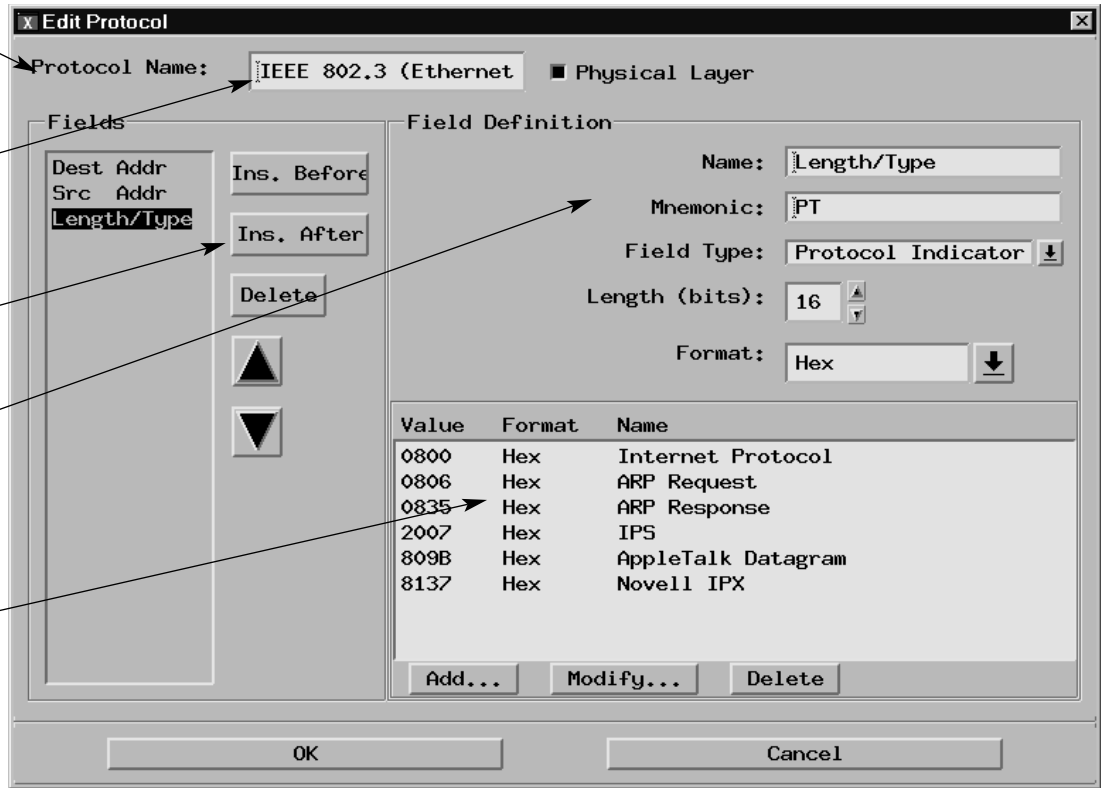

Edit or create a protocol using a text file.

Start with standard protocol definition and add custom fields with text file.

Insert protocol layer name.

Define protocol fields, number of bits, and format for trigger and display.

Define any user symbols to make triggering and display easier to use.

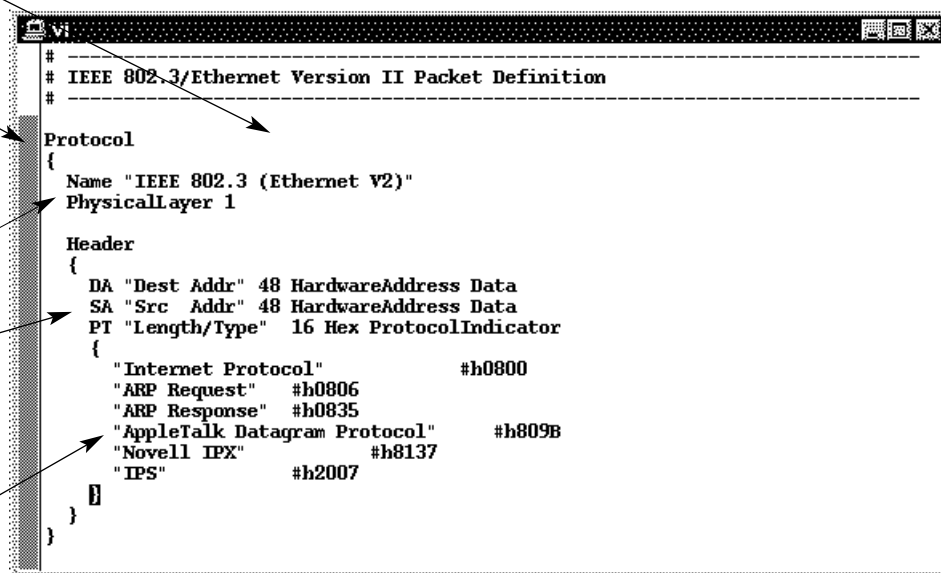

Figure 5.6.

Post-Processing and Analysis Tool Sets

Data Communications

Trigger

Trigger Functions Settings Overview Default Storing Status Save/Recall

General State, Telecom State Trigger function libraries...

Find Packet

Advanced - If/then
Advanced - 2-way branch
Advanced - 3-way branch
Advanced - 4-way branch

SRC ADDR SRC ADDR SRC ADDR
DST ADDR DST ADDR DST ADDR
... ..
... ..

Replace Insert before Insert after Delete

Trigger Sequence

1 FIND PACKET

On bus Bus #1

If IP Address occurs once

then Trigger and fill memory Help

Event Editor

Event Name: IP Address Long Field Names View Packet Bits

Protocol Stack

Internet Protocol

IEEE 802.3 (Ethernet V2)

Internet Protocol

Version XX Octal ↓
Header Length XX Decimal ↓
Precedence Don't Care ↓ Symbols ↓
Delay Don't Care ↓ Symbols ↓
Throughput Don't Care ↓ Symbols ↓
Reliability Don't Care ↓ Symbols ↓
Cost Don't Care ↓ Symbols ↓
MBZ X Binary ↓
Total Length XXXXX Decimal ↓
Identification XXXXX Hex ↓
Zero X
Do not fragment X
May Fragment X
Fragment Offset XXXX
Time To Live XXX
Protocol Don't Care
Header Checksum XXXX
Src Addr XXX.XXX.XXX.XXX
Dest Addr 15.19.3.116

Close

IP Address - Packet Bits

08.....15

```

0 XXXXXXXXXXXXXXXXXXXX
1 XXXXXXXXXXXXXXXXXXXX
2 XXXXXXXXXXXXXXXXXXXX
3 XXXXXXXXXXXXXXXXXXXX
4 XXXXXXXXXXXXXXXXXXXX
5 XXXXXXXXXXXXXXXXXXXX
6 0000100000000000
7 XXXXXXXXXXXXXXXXXXXX
8 XXXXXXXXXXXXXXXXXXXX
9 XXXXXXXXXXXXXXXXXXXX
10 XXXXXXXXXXXXXXXXXXXX
11 XXXXXXXXXXXXXXXXXXXX
12 XXXXXXXXXXXXXXXXXXXX
13 XXXXXXXXXXXXXXXXXXXX
14 XXXXXXXXXXXXXXXXXXXX
15 0000111100010011
16 0000001101110100
    
```

Close

Annotations:

- New packet trigger macros.
- Choose from a list of buses.
- Trigger on simple IP address instead of setting up trigger sequencer.
- Specify what action to perform once a packet is found.
- Specify protocol layer to trigger on.
- Use any defined protocol fields as a trigger, such as source address, destination address, etc.
- Physical representation of bit fields to be triggered on. This window is automatically updated when fields are edited.

Figure 5.7.

Post-Processing and Analysis Tool Sets

Data Communications

Use the bus editor feature to specify what protocol runs on your bus. This is helpful when probing more than one bus with a single state/timing module.

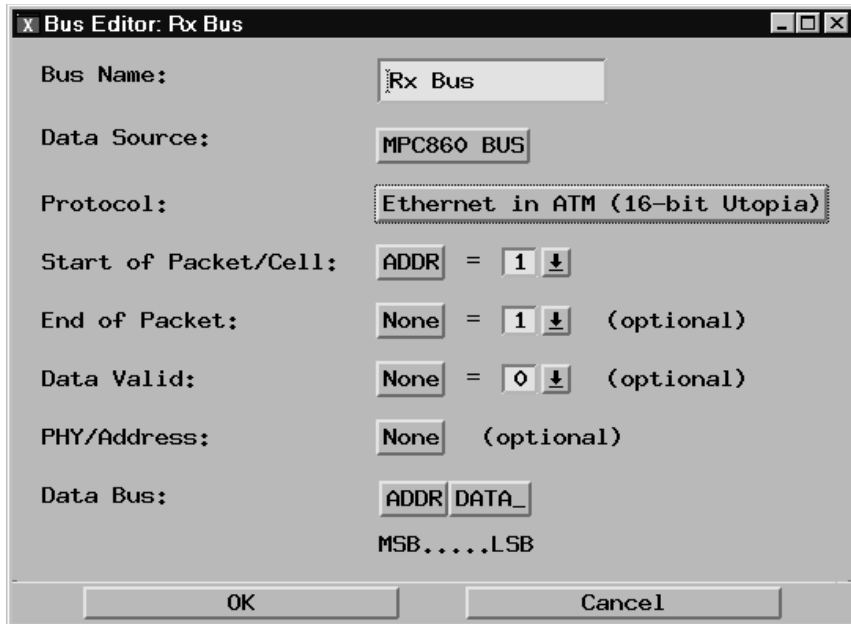
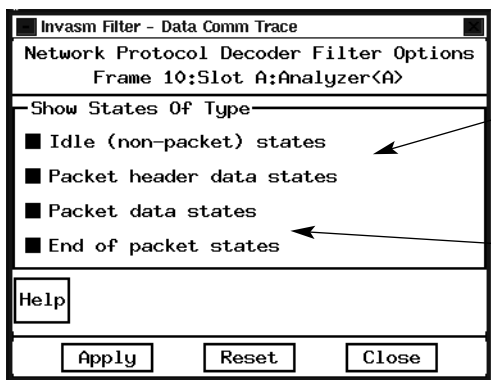

Figure 5.8.

Post-Processing and Analysis Tool Sets

Data Communications

Protocol Filters and Viewing Preferences



Filter captured data to only view key data for measurement.

Choose to view payload data with header information.

Select which protocol layers and fields to view in trace.

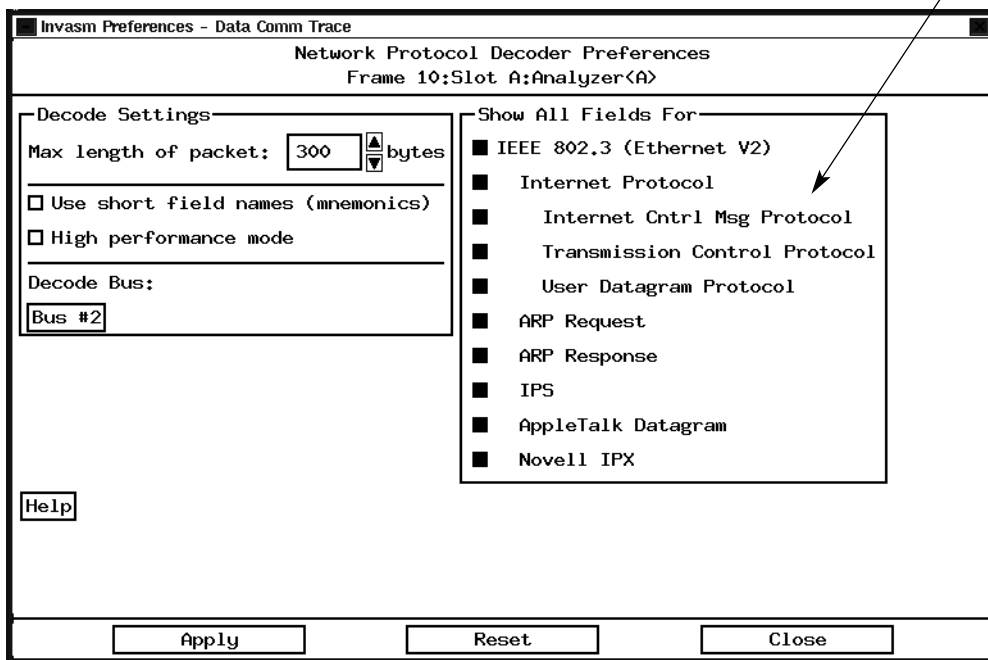

Figure 5.9.

Post-Processing and Analysis Tool Sets

Data Communications

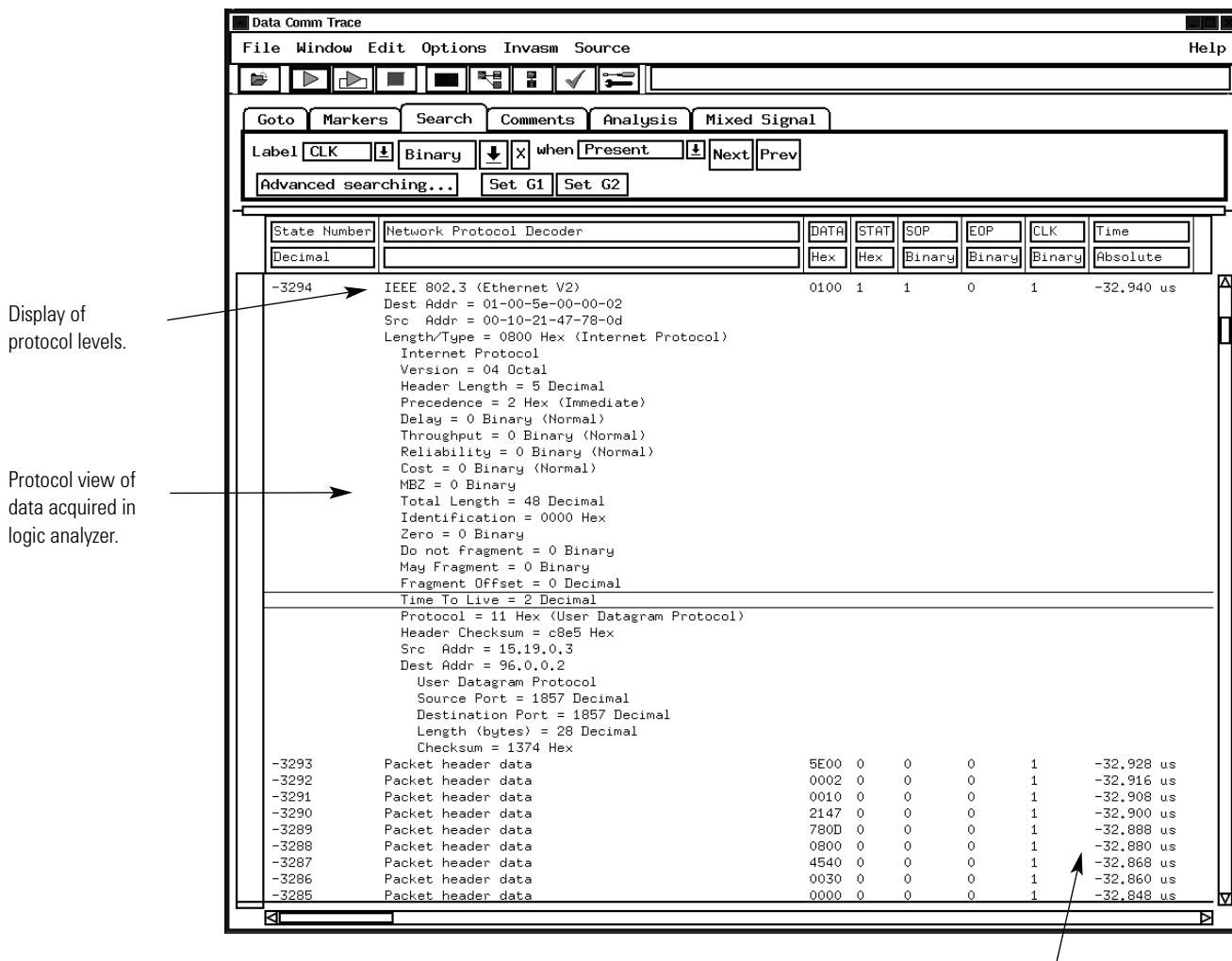

Figure 5.10.

Time tags for system level correlation of other data buses, memory interfaces, microprocessors, etc.

Post-Processing and Analysis Tool Sets

Data Communications

Global markers measure time intervals between packets on separate parallel interfaces or timing between the data path and a microprocessor.

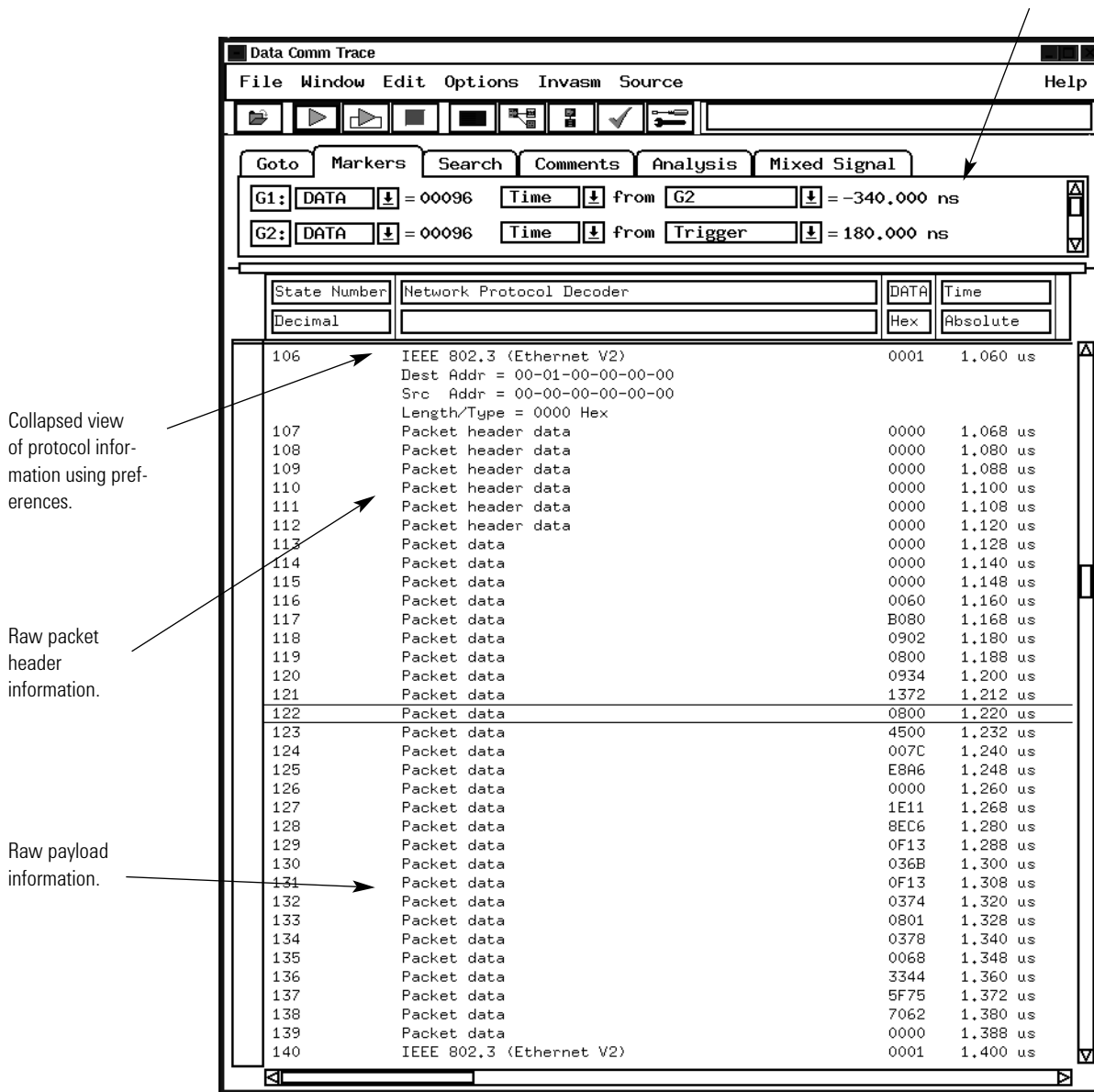

Figure 5.11.

Post-Processing and Analysis Tool Sets

System Performance Analysis

Optimize System Performance

Your design has to meet consistent performance requirements over a range of operating conditions and over a specific time period. Using the system performance analysis tool set, you can obtain answers to many of your questions concerning performance and responsiveness, software execution coverage, debug and system parameter analysis, etc.

Obtain Answers to the Following Questions:

Performance and Responsiveness

- What functions monopolize microprocessor bandwidth?
- What functions are never executed? What is the relative workload of each processor in a multiple-processor system?
- What is the minimum, maximum, and average execution time of a function (including calls)?
- How many interrupts does the system receive per consecutive time slice?
- What is the response time of the target system to an external event?

Software Execution Coverage

- Do test suites provide thorough coverage of the application?
- Is this function or variable accessed by the application?

Debug and System Parameter Analysis

- Does this pointer address the right memory buffer?
- How does the system react when it receives too many simultaneous interrupts?
- Is the stack size adequate?
- Is the cache size adequate?

Analog, Timing, and Bus Measurements

- What is the setup/hold time of this signal or group of signals?
- Is the distribution of voltages for this analog signal acceptable?
- Is this signal spending too much time in the switching region?
- What bus states occur most often?
- What is the bus loading?
- How does the bus affect overall system performance?
- How much time is spent in bus arbitration?
- What is the histogram of bus transfer times?

Processor/Cache Measurements

- Which microprocessor bus states occur most often?
- Which peripherals are used most often?
- What is the profile of load sharing in a multiple-processor system?
- How does the cache size affect system performance?

Product Description

The Agilent Technologies B4600B system performance analysis (SPA) tool set profiles an entire target system at all levels of abstraction—from signals to high-level source code. It clearly identifies the components that affect the behavior of your system. In addition to performance analysis, it can be used at any time to test and document many other characteristics, such as memory coverage and response time.

The SPA tool set generates statistical representations of the captured data. It shows the amount and percent of time spent in each of the targeted functions or data locations. Data is conveniently displayed in histograms and bar charts, reducing the time you spend analyzing results and identifying system bottlenecks.

Post-Processing and Analysis Tool Sets

System Performance Analysis

Product Characteristics

	SPA Tools			
	State Interval Display	Time Interval Display	Time Overview Display	State Overview Display
Generates	Statistical representations of the captured data Shows the amount and percent of time spent in each of the targeted functions or data locations.			
Provides	Histogram of event activity. Display shows the percentage of hits for each procedure, function, or event (states). Events are defined as patterns or ranges associated with any set of data (labels, symbols).	Histogram of event times. Display shows a distribution of the execution time of a specific function or of the time between two user-defined events.	Overview of occurrence rates over time. Measurements of the occurrence rate of any event, including interrupts, over time.	Overview of bus/memory activity. Display shows the number of hits for each possible bus state.
Usage	Helps prioritize functions that are candidates for duration measurements using the time interval tool.	Determines a specific routine's execution times and verifies signal timing specifications	Views the frequency of events over time.	First step of analysis or optimization process to identify which events occur most frequently.
Applications	Cache hit and miss analysis. Bus headroom analysis can be made by examining ratio of active to idle status states. Examines workload of each processor in a multi-processor system to determine if system is balanced.	Measures setup and hold times, the jitter between two edges, or the variation between two bus states.		Isolates defects such as invalid pointers (filtering). Distribution of signal voltages can tell whether a digital signal is spending too much time in the switching region. Evaluates the linearity of the output of a D/A converter.
Displays Include	Ability to be viewed simultaneously Filtering capabilities for removing portions of a trace that are not applicable to the analysis			
Maximum Number of Events	No theoretical limit. Up to 10,000 events tested with a standard configuration		Number of events limited by size of the window (e.g. pixels on the screen)	

Post-Processing and Analysis Tool Sets

System Performance Analysis

Product Characteristics (continued)

	SPA Tools State Interval Display	Time Interval Display	Time Overview Display	State Overview Display
Supplemental Information	Number of hits	Minimum time Maximum time Average time Standard deviation	Number of hits Time bucket width	Number of hits State bucket width
Display Modes	Sort by number of hits Sort alphabetically by event name	Sort by time Sort alphabetically by event name	Autoscale zoom	
Accumulate Mode	No theoretical limit to the number of acquisitions in accumulate mode. Any modification of the display will cause the display to revert back to the last data acquisition.			
Object File Format Compatibility	Object file formats are identical for SPA and the source correlation tool sets. See page 43.			
Off-Line Analysis and Post-Processing	All measurements can be saved using the file out tool. Data can be recalled at any time for later analysis using any SPA or other tool. Performance measurements can be exported to your host computer as histograms or as tabular formatted text files.			
Processor Support	Supports any analysis probe listed in Processor and Bus Support for Agilent Technologies Logic Analyzers (pub no. 5966-4365E)			
Data Sources	All measurement modules supported by the 16700 Series logic analysis systems serve without modification as data sources for the B4600B. The particular module determines time resolution and accuracy. Sample rate, channel count, memory depth and triggering are controlled by the user independent of the SPA tool set.			

Post-Processing and Analysis Tool Sets

System Performance Analysis

State Overview Tool

Narrow in on an area of interest using built-in qualification and zoom functions.

Pinpoint regions of high memory activity to determine which routines or operations are responsible for throughput bottlenecks.

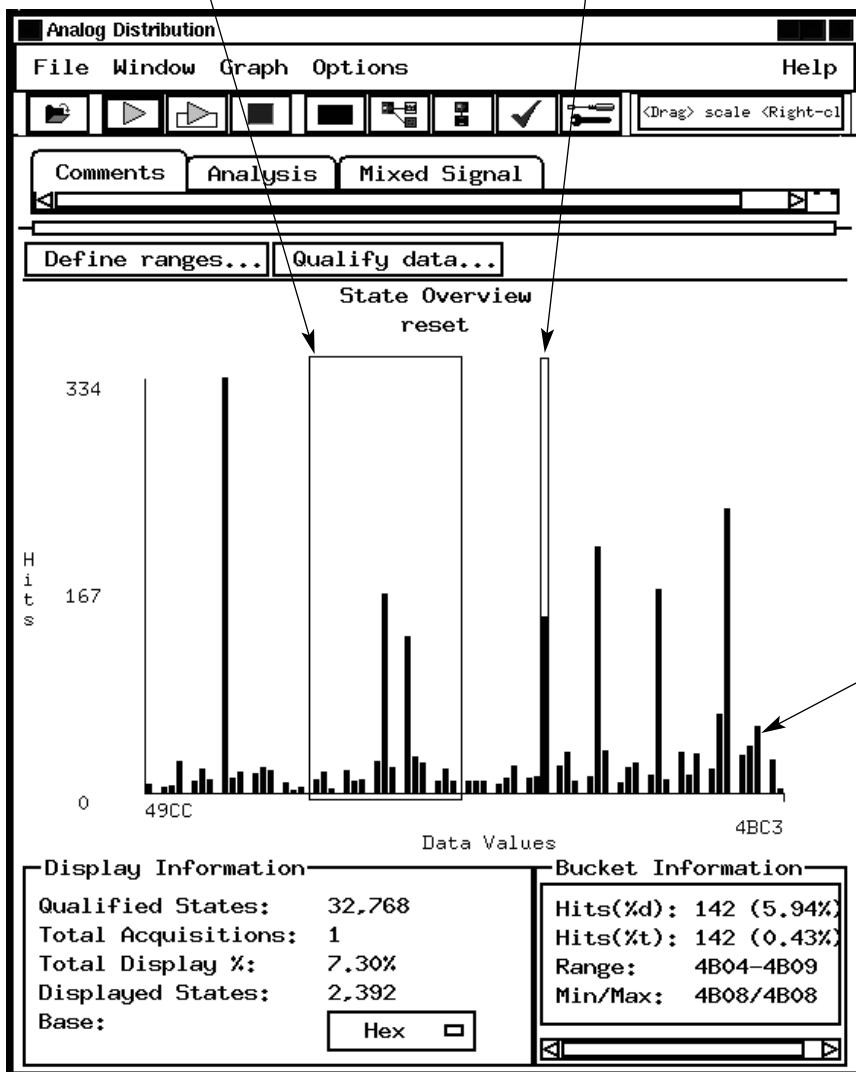

Figure 5.12. Identify which events occur most frequently.

Post-Processing and Analysis

System Performance Analysis

State Interval Tool

Sort and display symbols alphabetically by event name or by the number of hits.

Display just the symbols you want to evaluate by using the symbol-navigation utility. The utility automatically configures the tool for the selected function and variable names from large symbol files created by complex software projects.

To help simplify your display, delete all functions below a selected point with a single mouse click.

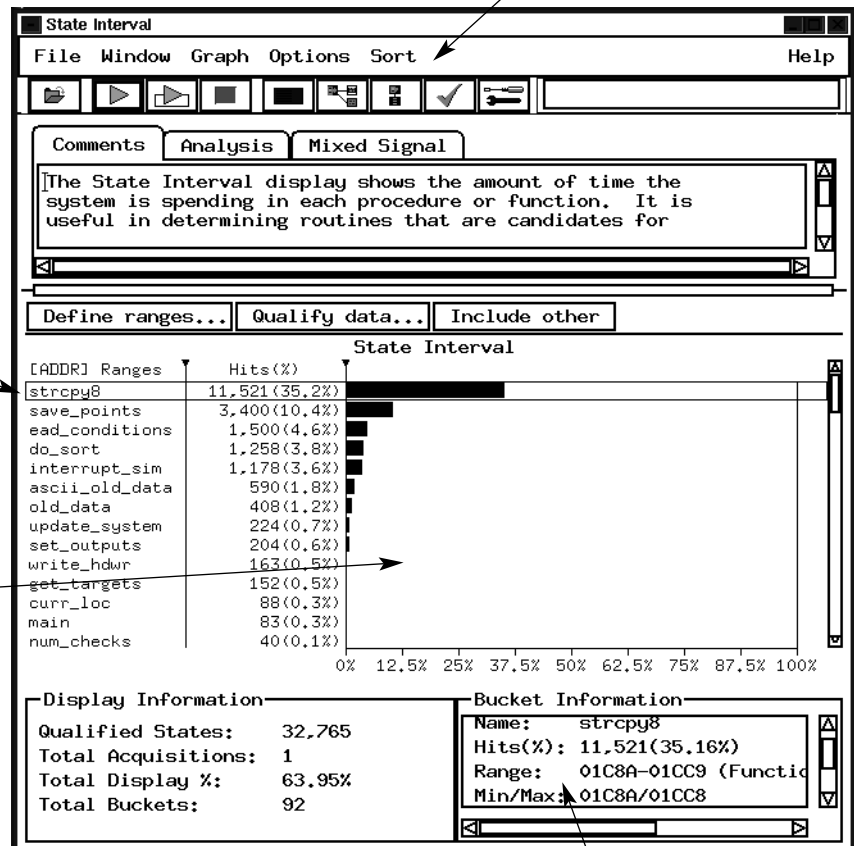

Pass the mouse over a histogram bar and bucket information gives you detailed information for each event.

Figure 5.13. Determine which functions use the most CPU cycles.

Post-Processing and Analysis

System Performance Analysis

Time Interval Tool

Because time interval measurements often depend upon hardware-software interaction, the event definition can be a combination of symbolics and hardware events. Data qualification can be used to define the specific hardware context in which the analysis will be made.

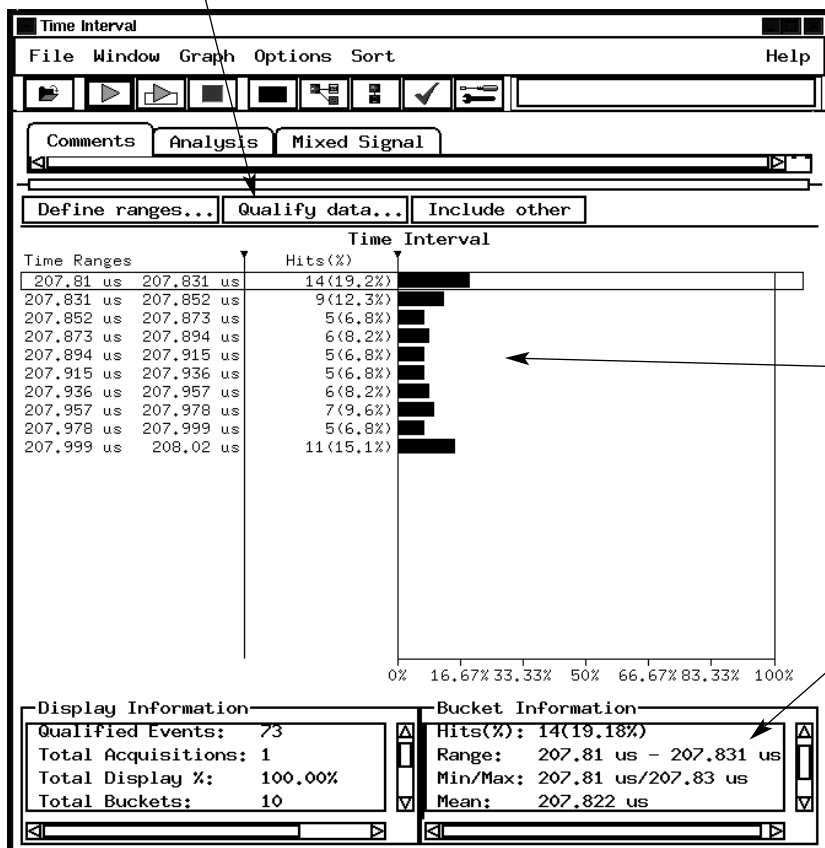

Data is displayed in histograms, which can be exported to your host computer either as histograms or as tabular formatted text files.

Statistics such as maximum time, minimum time, standard deviation and mean help you document system behavior. Use "accumulate mode" to analyze the behavior of your system over a long period of time.

Figure 5.14. Determine a specific routine's execution times.

Post-Processing and Analysis Tool Sets

System Performance Analysis

Time Overview Tool

Use "Comments" to document your trace. The "Comments" field contents are saved with the configuration and data.

Use the markers in this window to correlate interrupts to a state listing or timing waveform.

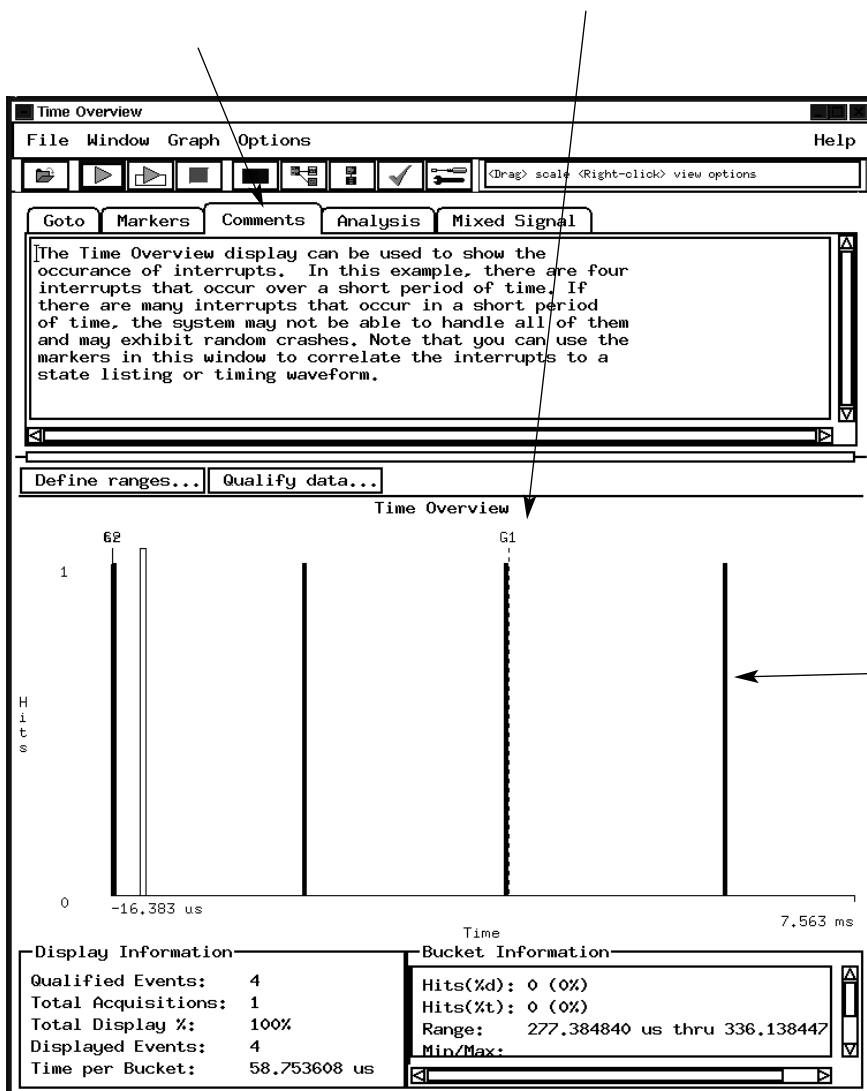

Elusive system crashes are often caused by too many interrupts occurring over a short period of time. If the software cannot handle all simultaneous service requests, the system can exhibit random defects while leaving no clues as to their cause. In this situation, you need a tool that can measure and display interrupt loading.

Figure 5.15. View the frequency of events over time.

Post-Processing and Analysis Tool Sets

Serial Analysis

Solve Serial Communication Problems

Your system may use serial buses to communicate between ICs and to transfer data to and from peripheral devices. Sifting through thousands of serial bits by looking at long vertical columns of captured 1's and 0's can be very tedious, time-consuming, and error-prone.

Obtain Answers to the Following Questions:

- Is the software sending the correct message?
- Is the communication hardware acting as expected?
- When multiple messages are involved, in what order is data being transmitted?
- How does the serial bus activity correlate to the target system processor?
- What is causing the data corruption in the target system?

Product Description

The Agilent Technologies B4601B serial analysis tool set is a general-purpose tool that allows easy viewing and analysis of serial data.

The tool set enables you to:

- Convert acquired serial bit streams into readable parallel word formats
- Time-correlate real-time serial traces to system activity
- Remove stuffed bits from the data block
- Process frame and data portions separately
- Process serial data from a signal with or without an external clock reference
- Capture and analyze high-speed (1 GHz) serial buses

Post-Processing and Analysis Tool Sets

Serial Analysis

When You Want to Analyze Serial Bit Streams . . .

...specify which signal you want to convert to parallel format by selecting a specific bit of any available label.

...accept the default output label "Parallel" or modify the label name for easy recognition.

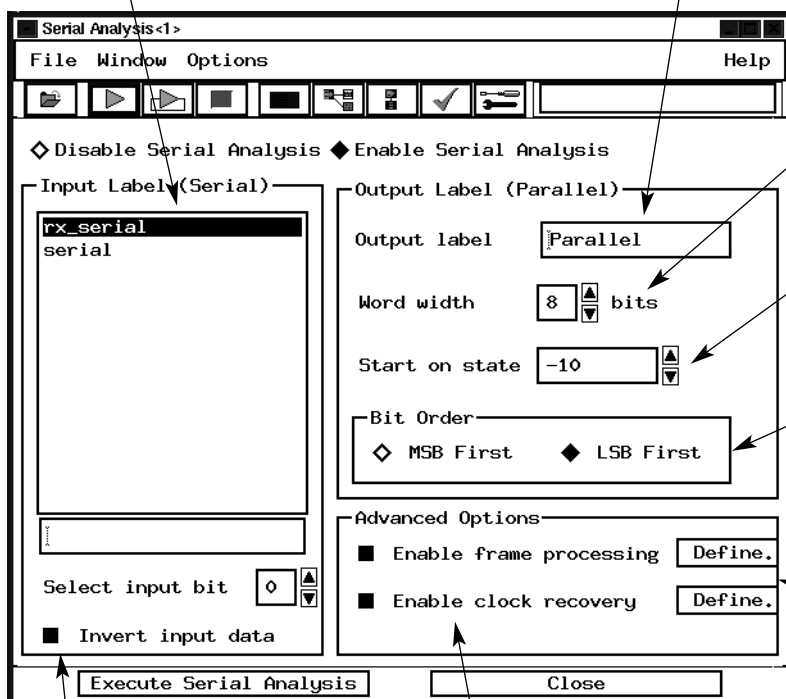

...set the output parallel word width (up to 32 bits).

...select the specific state in the trace where conversion begins.

...specify the order in which the bits occur in the serial data stream
MSB = Most Significant Bit first
LSB = Least Significant Bit first.

...enable frame processing to extract all instances of a defined frame.

...maintain or invert the input serial bit stream.

...capture serial data with or without an external clock reference. Enable clock recovery for an incoming serial bit stream that has no external clock reference.

(RS-232 is an example of a bus with clocking embedded within the serial bit stream).

Figure 5.16.

Post-Processing and Analysis Tool Sets

Serial Analysis

To Separate Frame Information from the Data Block . . .

...accept the default start of frame label "Start" or modify the label to a name of your choosing.

...specify the pattern that designates the start of a frame.

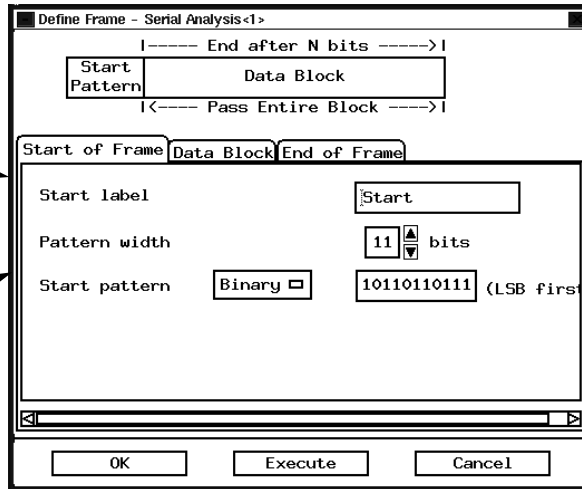

...get immediate feedback as you configure the tool set for your data. This diagram changes as you make your framing and data block selections.

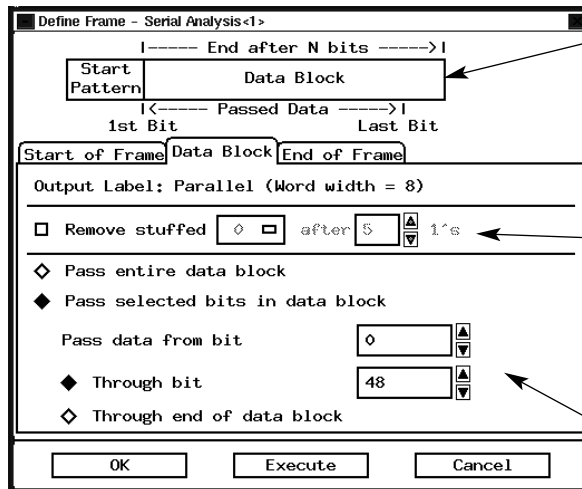

...remove stuffed 0s or 0/1s from the trace before other serial analysis functions are performed. Some protocols use bit stuffing to maintain clock synchronization.

...specify whether the end of frame occurs at the end of a data block of X bits or on a specified pattern.

...accept the default end of frame label "End" or enter a different name.

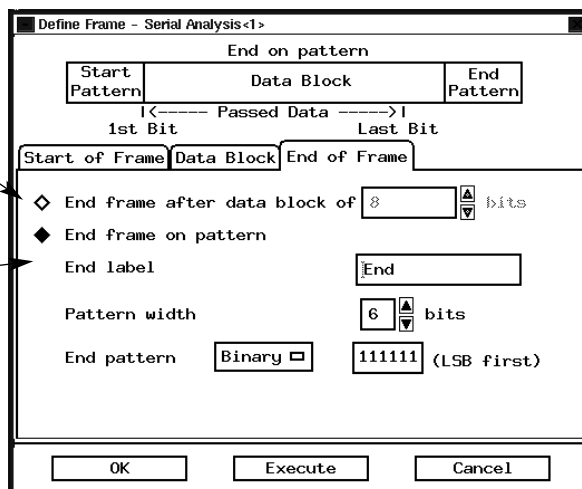

...specify the portion of the data block for the serial-to-parallel conversion.

Figure 5.17.

Post-Processing and Analysis Tool Sets

Serial Analysis

To Acquire a Serial Bit Stream without an External Clock

Reference . . .

...set the sample period of your timing analyzer to take four or more samples for each serial bit.

...accept the "Samples" default label or enter a new label name.

...specify the embedded bit time of the serial bit stream.

...specify the incoming signal's data encoding method, normal or NRZI.

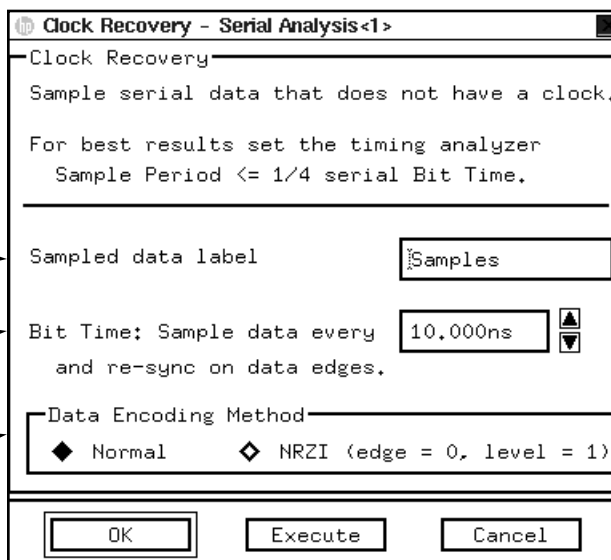

Figure 5.18.

Clock Recovery Algorithm

1. For analysis purposes the data is captured in conventional timing mode using the internal timing analyzer clock as the clock reference. Set the sample period of the timing analyzer to take four or more samples for each serial bit.
2. The timing analyzer data is sampled in the middle of each bit according to the serial bit rate defined in the clock recovery window.
3. Data edges (transitions from 0 to 1 or 1 to 0 in the timing analyzer trace) are used to resynchronize the sampling.

How Clock Recovery Works

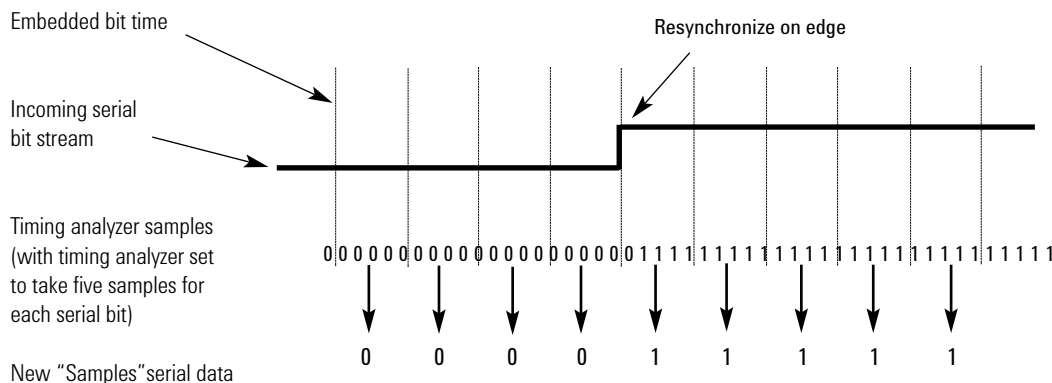

Figure 5.19.

Post-Processing and Analysis Tool Sets

Serial Analysis

Once the Serial Bit Stream is Acquired . . .

This example shows the conversion of an RS-232 serial bit stream. The data sent to the printer includes the column header "MACHINE".

...configure the serial tool once for your specific bus, then save the configuration for future uses.

...view the serial-to-parallel conversion in the format that is easiest for you — waveform or listing.

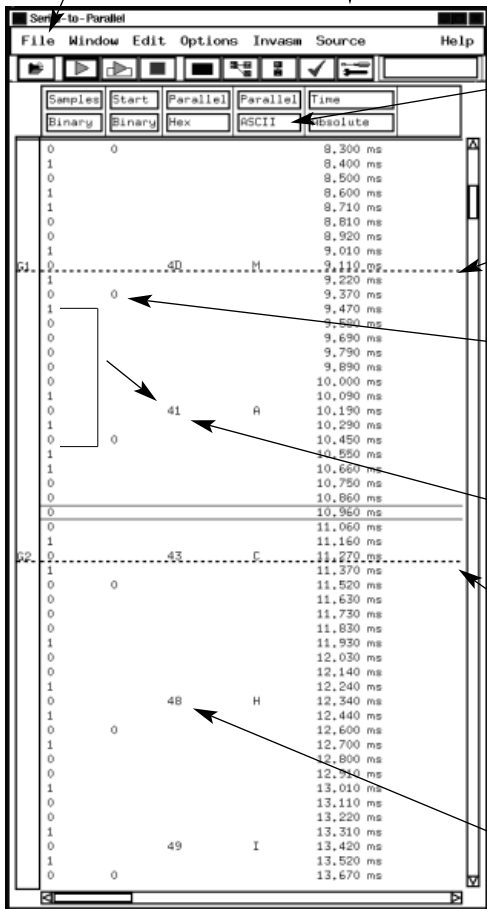
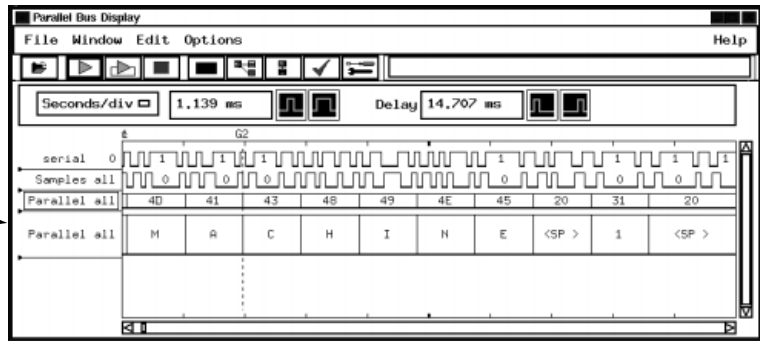

...display the parallel data in binary, hex, octal, decimal, ASCII or Twos Complement.

...use the global markers and time tags to correlate real-time serial traces to other system activity.

...synchronize the start of the serial-to-parallel conversion to the start of the frame pattern for your specific bus.

...convert the data block into parallel words, in this case 8-bit words.

...find the Nth occurrence of specific frames or data relative to the trigger, other markers, or the beginning or end of the trace. Markers allow you to quickly search from frame to frame in the data.

...view the data in the order in which the bits occur in the serial stream, in this case LSB.

Figure 5.20.

Post-Processing and Analysis Tool Sets

Serial Analysis

Product Characteristics

Data Sources

All state and timing measurement modules supported by the 16700 Series logic analysis systems serve without modification as data sources for the B4601B serial analysis tool set. The particular measurement module used determines time resolution and accuracy. Sample rate, channel count, memory depth and triggering are controlled by the user independent of the serial analysis tool.

Because every trace is non-intrusive, and every event captured in the trace is time-stamped, you can correlate activity from your serial bus with other events in the target system.

The Agilent Technologies 16720A and 16522A pattern generator modules can be used to generate your own serial test data.

Maximum Parallel Word Width
32 bits

Parallel Data Display Types

Binary, Octal, Hex, Decimal, ASCII, Twos Complement

Off-line Analysis and Post-Processing

All measurements can be saved using the file out tool. Data can be recalled at any time for later analysis using any analysis or display tool. Serial measurement data can be exported to your host computer as ASCII files.

Serial Measurement Characteristics

		16517A/18A	16710A/11A/12A	16715A	16716A	16717A/18A/19A	16750A/51A/52A
Maximum serial Mbits/ trace depth	Clocked data [1]	64 Kbits	8 Kbits/32 Kbits/	2 Mbits	512 Mbits	2 Mbits/8 Mbits/	4 Mbits/16
	Unclocked data [2]	16-32 Kbits	128 Kbits 4 Kbits/16Kbits/ 64 Kbits	1 Mbit	256 Mbit	32 Mbits 1 Mbit/4 Mbits/ 16 Mbits	32 Mbits 2 Mbits/8 Mbits/ 16 Mbits
Maximum serial bus frequency	Clocked data [3]	1 Gbit/s	100 Mbits/s	167 Mbits/s	167 Mbits/s	333 Mbits/s	400 Mbits/s
	Unclocked data [4]	1 Gbit/s	125 Mbits/s	167 Mbits/s	167 Mbits/s	167 Mbits/s	200 Mbits/s
Minimum serial bus frequency	Clocked data	20 Mbit/s	No limit	No limit	No limit	No limit	No limit
	Unclocked data [5]	765 Mbits/s	5 Kbits/s	50 bits/s	50 bits/s	50 bits/s	50 bits/s

Information in Table above calculated according to notes [1] to [5]

[1] =Maximum State Memory Depth

[2] =Maximum Timing Memory Depth/4

[3] =Maximum State Frequency

[4] =Maximum Timing Frequency/4

[5] =1/(Maximum sample period x 20)

Post-Processing and Analysis Tool Sets

Tool Development Kit

Customize Your Measurements

The ability to interpret and display information is vital to your project. At times the information you need can be buried in the raw data of your measurement. This might be due to one of several reasons:

- The use of a protocol, encoded data, or proprietary bus
- Events that happen only under certain conditions
- The need to analyze system performance
- The need to analyze data across a large number of repetitive measurements

Product Description

The Agilent Technologies B4605B tool development kit provides a complete environment for creating custom tools that processes data using the powerful search and filtering capabilities of the logic analysis system. Features of the tool kit include:

- Fast, compiled and optimized C code
- Push button compiling, no make files
- A rich library of functions that speeds development
- Extensive examples of code
- The creation of installable tools
- One year of technical support for the B4605B

Data is processed quickly by the custom tools, because they consist of compiled, optimized C code. A C language programming background is highly recommended. A tutorial, extensive examples, and a rich library of functions are provided that help you easily access analyzer data and the tool's interface.

The custom tools can be used on any 16700 Series logic analysis system. This allows you to purchase just one or two copies of the development kit and develop custom tools to support a large number of analyzers.

Enhance Data Displays

- Color-code specific states of your trace.
- Display some of your trace data in engineering units.
- Convert the raw trace of a proprietary bus to a transaction-level trace of that bus.

Manipulate Data

- Unravel interleaved data into two or more columns of data.
- Combine the traces of two different analyzers into one trace, with each column being combined or separately displayed as prescribed by you.
- Modify your scope trace using an algorithm developed by you, such as an analog filter, beat frequency, or DSP algorithm.

Read or Write External Files

- Accumulate information from repetitive traces taken by the analyzer in a file on your PC or UNIX workstation.
- Write specific types of states or trace data that have been analyzed to an Excel consumable ASCII file on your PC or UNIX workstation.
- Use information read from a file on your PC or UNIX workstation to modify the display of an analyzer trace.

Post-Processing and Analysis Tool Sets

Tool Development Kit

Custom Tool Example, Added Text in Trace

This example shows how a custom tool can convert data to text to present information in an easy-to-understand form.

The original trace comes from a control unit in an automobile. Embedded in the data is information about the engine and transmission. When MODE = 0, DATA represents engine information, including RPM, fuel level, fuel to air ratio, and manifold pressure. When MODE = 1, DATA represents transmission information, including gear position and temperature.

Original Trace

This custom tool allows the user to specify Fahrenheit or Centigrade for the engine temperature data.

Output of Custom Tool

Parameter Interface of Custom Tool

Figure 5.21.

Post-Processing and Analysis Tool Sets

Tool Development Kit

Custom Tool Example, Microprocessor Code Reconstruction

The original trace came from the bus of a MPC 555 processor. As you can see, no data was placed on the bus at the time of the trace because cache memory was turned on. Normally, it would not be possible to inverse assemble this trace.

The output of the custom tool in this example is shown. Notice that there is now data in the DATA column. The custom tool was able to reconstruct the code flow after the trace was taken. The code was reconstructed by using the branch trace messages and information in the SRecord file creat-

ed when the code was compiled. The tool took the address of the appropriate states in the trace data and found the corresponding code (data) in the SRecord file. This created a trace that the MPC 555 inverse assembler could operate on properly.

State Number	ADDR	DATA	STAT
Decimal	Hex	Hex	Hex
-2	3FA838	00000000	1F40FE0B
-1	3FA9B8	00000000	1F40FE0B
tr 0	3FA608	00000000	1B45FE03
1	3FA608	00000000	1F40FE03
2	3FA608	00000000	1F40FE03
3	3FA608	00000000	1F00FE03
4	3FA608	00000000	1F01FE03
5	3FA608	00000000	1F00FE03
6	3FA608	00000000	1F00FE03
7	3FA608	00000000	1F01FE03
8	3FA608	00000000	1F00FE03
9	3FA608	00000000	1F00FE03
10	3FA624	00000000	1B06FE0B
11	3FA624	00000000	1F40FE0B
12	3FA624	00000000	1F40FE0B
13	3FA624	00000000	1F40FE0B
14	3FA624	00000000	1F41FE0B
15	3FA624	00000000	1F40FE0B
16	3FA624	00000000	1F40FE0B
17	3FA624	00000000	1F41FE0B
18	3FA624	00000000	1F40FE0B
19	3FA624	00000000	1F00FE0B
20	3FA640	00000000	1B06FE0B
21	3FA640	00000000	1F00FE0B
22	3FA640	00000000	1F00FE0B
23	3FA640	00000000	1F00FE0B
24	3FA640	00000000	1F01FE0B
25	3FA640	00000000	1F00FE0B
26	3FA640	00000000	1F00FE0B
27	3FA640	00000000	1F41FE0B
28	3FA640	00000000	1F40FE0B
29	3FA640	00000000	1F40FE0B

Original Trace

ADDR	MPC555 Inverse Assembly	DATA	STAT
Hex	Mnemonics v6.0	Hex	Hex
3FA838	wait	00000000	1F40FE0B
3FA9B8	wait	00000000	1F40FE0B
tr 000004	data read	00000000	1940FF03
3FA608	wait	00000000	1F40FF03
3FA608	wait	00000000	1F40FF03
3FA608	wait	00000000	1F00FF03
3FA608	andi. r10 r30 0002	73CA0002	1D00FF03
3FA608	wait	00000000	1F00FF03
3FA608	wait	00000000	1F00FF03
3FA60C	cmplwi cr0 r10 0000	280A0000	1D00FF03
3FA608	wait	00000000	1F00FF03
3FA608	wait	00000000	1F00FF03
3FA610	beq cr0 003FA624	41820014	1900FF0B
3FA624	wait	00000000	1F40FF0B
3FA624	wait	00000000	1F40FF0B
3FA624	wait	00000000	1F40FF0B
3FA624	andi. r9 r30 0004	73C90004	1D40FF0B
3FA624	wait	00000000	1F40FF0B
3FA624	wait	00000000	1F40FF0B
3FA628	cmplwi cr0 r9 0000	28090000	1D40FF0B
3FA624	wait	00000000	1F40FF0B
3FA624	wait	00000000	1F00FF0B
3FA62C	beq cr0 003FA640	41820014	1900FF0B
3FA640	wait	00000000	1F00FF0B
3FA640	wait	00000000	1F00FF0B
3FA640	wait	00000000	1F00FF0B
3FA640	andi. r8 r30 0008	73C80008	1D00FF0B
3FA640	wait	00000000	1F00FF0B
3FA640	wait	00000000	1F00FF0B
3FA644	cmplwi cr0 r8 0000	28080000	1D40FF0B
3FA640	wait	00000000	1F40FF0B
3FA640	wait	00000000	1F40FF0B
3FA648	beq cr0 003FA65C	41820014	1940FF0B

Output of Custom Tool

By entering information here, users can direct the tool to the correct SRecord file and control how much of the data the tool is to operate on. They can also indicate if the AT2 pin of the MPC 555 processor is in use.

Parameters - Tool Development Kit<1>

SREC Path: /hplogic/configs/danf/ecs.srec

Start State: 0

End State: 1000

AT2 Pin Working (yes/no): no

Figure 5.22. Code reconstruction

Parameter Window of Custom Tool

Post-Processing and Analysis Tool Sets

Tool Development Kit

Custom Tool Example, Multiplex Data

Custom tools can combine several lines of data acquired sequentially under one label into one line of data. However the data to be combined does not have to come from the same label, it can come from different labels. The labels can even come from different analyzers.

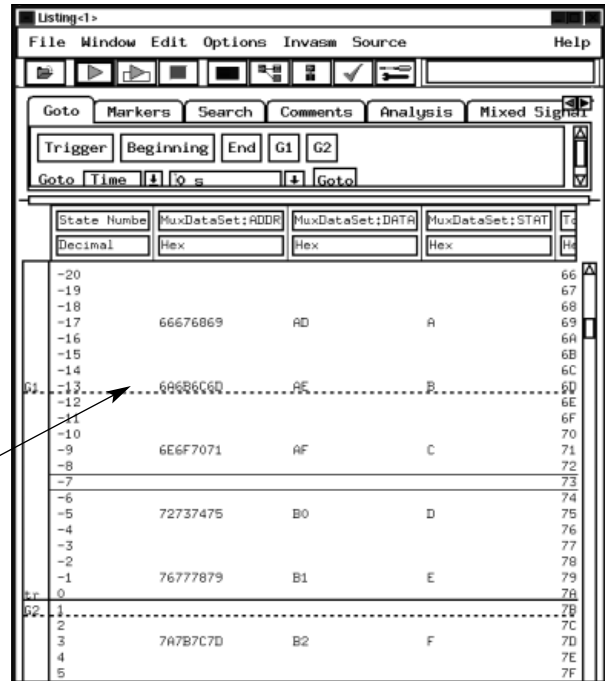
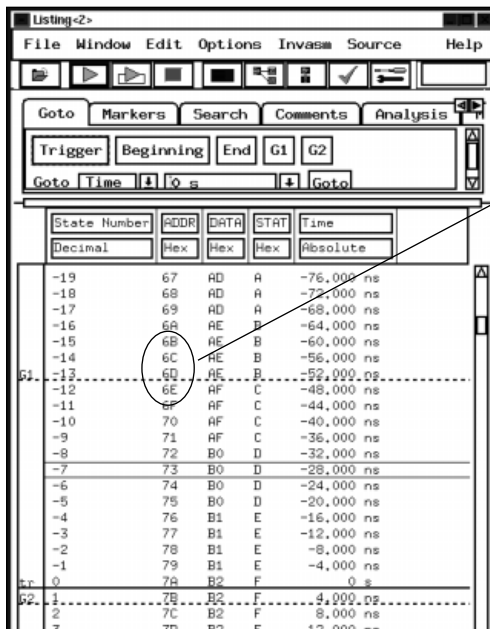

Output of Custom Tool

Original Trace

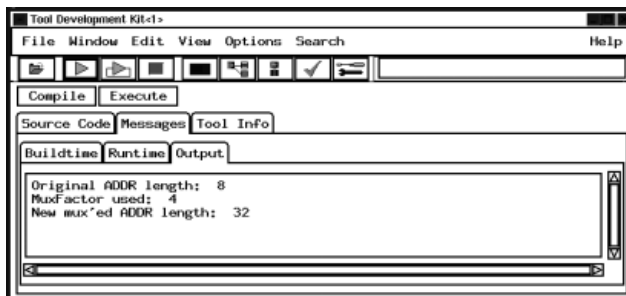

At left are the parameter window and message display created by the custom tool in this example. Parameters allow the user to control different aspects of what the tool does to the acquired trace. The user can change the parameters and hit the execute button to change the output of the tool. The output dialog to the left displays information generated by the tool.

Figure 5.23.

Parameter and Output Windows

Post-Processing and Analysis Tool Sets

Tool Development Kit

Custom Tool Development Environment

This is the main window for developing code with the tool development kit.

Select this button to compile the code displayed in the "Source Code" tab.

Load a file created on another system or create your code here using the "Source Code" editor.

Compilation status is shown at the bottom of the tool development kit Display window.

Select this button to cause the compiled code to operate on the acquired data.

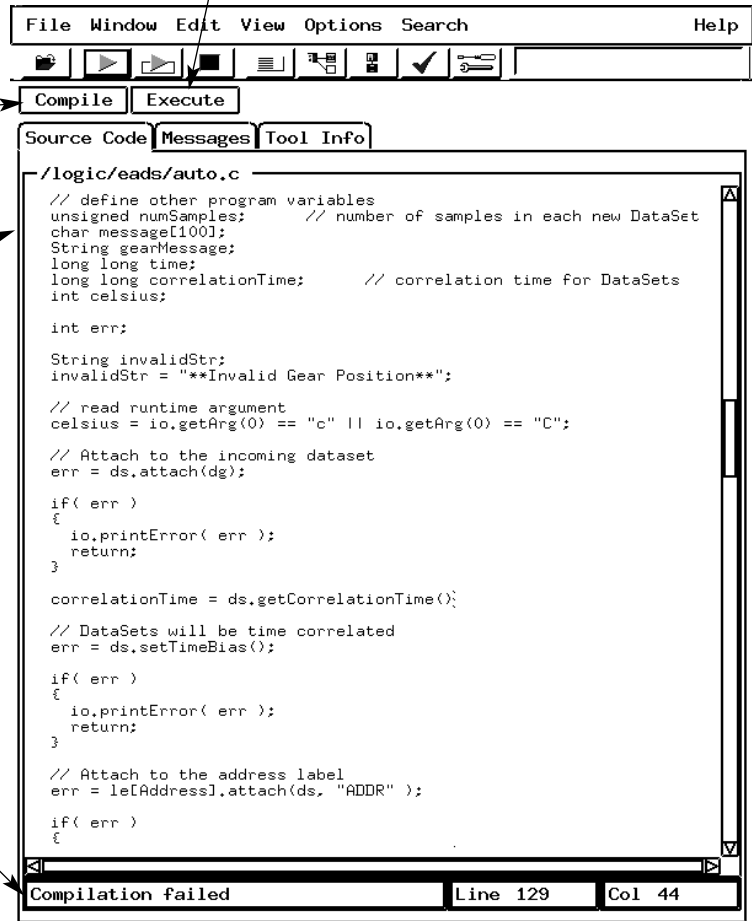

Runtime errors are displayed in the "Runtime" tab.

Errors generated during a compile are displayed in the "Buildtime" tab.

Output generated during the tool's execution are displayed in the "Output" tab.

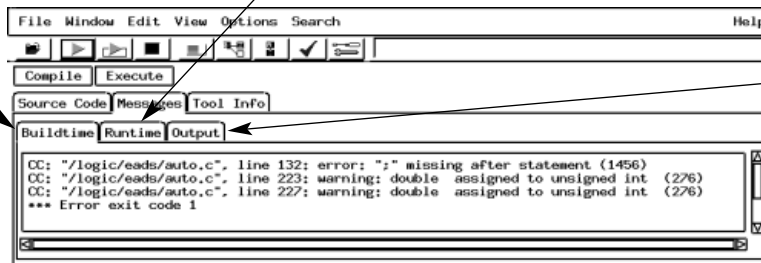

Figure 5.24. TDK development environment

Post-Processing and Analysis Tool Sets Tool Development Kit

Product Characteristics

Analyzer compatible custom tools will run on any 16700 Series analyzer running version A.01.40.00 or greater. In some rare instances, changes in the operating system can require that your tools be recompiled in order to run on that version of the operating system.

Analysis and Stimulus Modules

The tool development kit supports the following Agilent Technologies measurement modules:

- 16715A, 16716A, 16717A, 16718A, 16719A, 16750A, 16751A, 16752A
- 16710A, 16711A, 16712A
- 16557D
- 16556A/D, 16555A/D
- 16554A
- 16550A
- 16534A, 16533A
- 16517A, 16518A
- 16522A, 16720A
- 16740A, 16741A, 16742A

C Compiler

The libraries provided with the C compiler allow you to perform standard operations such as creating ASCII or binary files, reading from these files, writing or appending to these files, and IEEE 764 floating point operations.

Provided Functions

Agilent Technologies provides a rich library of functions that allow you to copy data sets, create new data sets with new labels, and to reorganize the acquired data under these new labels or to include data or text derived from the acquired data.

The functions allow:

- Stopping a repetitive run
- Filtering of the data
- Randomly accessing the data
- Searching the data
- Displaying the data in one of eight colors
- Accessing the trigger point
- Accessing the acquired time or state of the data
- Outputting text strings to the tool's display window
- Outputting errors to the runtime window

By using two of the provided functions, a simple user interface can easily be created that consists of label strings and input fields. This allows the input of parameters during the tool's execution.

Post-Processing and Analysis Tool Sets

Licensing Information

Licensing and Miscellaneous

	Description
System Configuration Requirements	<ul style="list-style-type: none"> • 16700 Series logic analysis system • Desired tool set(s) • Supported and compatible measurement hardware
Tool Set Control	<ul style="list-style-type: none"> • Locally control and view tool set measurements • Remotely access any tool set from a PC or workstation through a web browser or X-window emulation software.
File Access	<ul style="list-style-type: none"> • Access source files or other development environment applications (compiler, debugger) from the logic analyzer via Telnet, NFS, or mapped file systems, and X-Windows client/server protocols. • Save or access files via the standard network capabilities of the logic analyzer, such as FTP, NFS, or CIFS (Common Internet File System for Windows 95/98/NT based PCs.
Ordering and Shipment	<ul style="list-style-type: none"> • When a tool set is ordered with a 16700 Series mainframe, the tool set is shipped installed and ready to run (Unless option 0D4 is ordered.) • Tool set proof-of-receipt is provided by the entitlement certificate. See page 121 for ordering information.

Tool Set Licensing Information

License Policy	The 16700 Series logic analysis systems' tool set software is licensed for single-unit use only. Licenses are valid for the life of the tool set. Software updates do not affect the license.
Nodelock Mode	<ul style="list-style-type: none"> • Tool set licenses are shipped or first installed as nodelocked applications. Nodelocked means that use of the tool set license is only allowed on the single node (16700 Series analyzer on which it is installed). Tool sets ordered with a 16700 Series mainframe will be installed with a permanent password and are ready to run. • For tool sets purchased as upgrades to existing 16700 Series mainframes, you must access the Agilent password redemption web site to obtain a password. Your entitlement certificate provides the web URL and alternate contact information. Password turnaround is generally the same business day.
Free Tool Set Evaluation (Temporary Demo License)	A single temporary license is available for any tool set type not previously licensed on a node. The temporary password for any node on any tool set is "demo". The temporary license is valid for 21 calendar days from first entry of the password in the license management window of the 16700 Series logic analysis system.
License Management	Licenses are managed from 'Licensing...' in the Admin tab of System Admin. Licenses are reserved at the start of a measurement session. They remain in use until the measurement session is terminated.
Password Backup	Passwords can be backed up to a floppy disk or network file. Should the passwords on your 16700 Series logic analysis system hard drive become corrupted, the tool set passwords can be reinstated by copying your backed up password file to: /system/licensing/license.dat

Time Correlation with Agilent Infiniium Oscilloscopes

E5850A Logic Analyzer - Oscilloscope Time Correlation Fixture

E5850A Logic Analyzer – Oscilloscope Time Correlation Fixture

The Agilent E5850A time correlation fixture allows you to make time-correlated measurements between a 16700 logic analyzer and an Agilent 548XX Series Infiniium oscilloscope to solve the following types of problems more effectively:

- Verifying signal integrity
- Tracking down problems caused by signal integrity
- Verifying correct operation of A/D and D/A converters
- Verifying correct logical and temporal relationships between the analog and digital portions of a design

Agilent's E5850A time correlation fixture works in conjunction with software in the 16700 family logic analyzers, and any Agilent Infiniium 54800 Series oscilloscope, to deliver the following features:

- **Automatic de-skew.** Measurements between the logic analyzer and Infiniium oscilloscope are automatically de-skewed in time. This saves you time and gives you confidence in the measurement results.
- **Combined waveform display.** The Infiniium oscilloscope waveforms are displayed in the waveform display window on the 16700 logic analyzer, along with timing analyzer waveforms. This allows you to instantly visualize time relationships among oscilloscope and timing measurements.
- **Global markers.** The global markers in the 16700 may be used to measure time among all measurements made in the logic analyzer and Infiniium oscilloscope measurements.

- **Tracking markers.** The Infiniium oscilloscope's time markers track the global markers in the 16700 logic analyzer. If you wish to view a waveform in greater detail on the oscilloscope's display, or measure a voltage level using the oscilloscope's voltage markers, this feature allows you to relate information on the oscilloscope's display precisely to corresponding information on the logic analyzer display.



Figure 5.26. E5850A time correlation fixture.



Figure 5.25. Infiniium oscilloscope waveforms are displayed in the 16700 logic analyzer waveform display window along with logic analyzer timing waveforms, accurately time-correlated.

Compatibility

For Infiniium scope model number	Software version for 16700 series logic analyzer	Software version for oscilloscope
54810A 54815A 54820A 54825A 54835A 54845A 54856A	A.02.20.00 or higher	A.04.00 or higher
54830B 54831B 54832B	A.02.50.00 or higher	A.01.00 or higher

The E5850A requires the versions of operating software indicated in the table

Mainframe Specifications and Characteristics

Agilent 16700 Series Technical Information

System Software

All features and functionality described in this document are available with system software version A.02.20.00

Mass Storage

Hard Disk Drive	9 GB formatted disk drive
Floppy Disk Drive	
• Capacity	1.44 MB formatted
• Media	3.5 inch floppy
• Formats	MS-DOS (Read, write, format), LIF (Read only)

Internal System RAM

Standard	128 MB
Option 003 (Must be ordered at time of frame purchase)	256 MB total

Supported Monitor Resolutions

Standard	640 x 480 through 1280 x 1024 (The 16702B has a built-in 800 x 600, 12.1" (26.2mm) diagonal monitor.)
Option 003 (Must be ordered at time of frame purchase)	Adds support for up to 1600 x 1200

LAN, IEEE 802.3

Physical Connectors	16700B Series: 10BaseT/100BaseT-X (ethertwist): RJ-45 16700A Series: 10BaseT (ethertwist): RJ-45; 10Base2: BNC
Protocols Supported	TCP/IP NFS CIFS (Windows® 95/98/NT) [1] FTP NTP PCNFS
X-Window Support	X Window system version 11, release 6, as a client and server

[1] User and share level control supported for Windows NT® 4.0. Share level control only supported for Windows 95/98.

Mainframe Specifications and Characteristics

Agilent 16700 Series Technical Information (continued)

Web Server

Supported from Instrument Web Page	Measurement status check, remote display, installation of PC application software, link to Agilent's Test and Measurement site
PC Requirements	Pentium® (family) PC (200 MHz, 32 MB RAM) running Windows 95, Windows 98, or Windows NT 4.0 with service pack 3 or higher
Supported Web Browsers (on Your PC or Workstation)	Internet Explorer 4.0 or higher, Netscape 4.0 or higher

IntuiLink Support

Installation of PC Application Software	Directly from instrument web page
MS Excel	Excel 97 Version 7.0 or later. Excel limits maximum trace depth to 64K per sheet.

Available Data Formats

Fast Binary (Compressed Binary Format)	High performance transfer rate. Includes source code to parse data. Available via File Out.
Uncompressed Binary	Includes utility routines. Available via RPI.
ASCII	Provides same format as listing display, including inverse-assembled data. Available via RPI and File Out.
Pattern Generator Binary	Used to load large amount of stimulus (> 1M) into the 16720A pattern generator

Intermodule Bus (IMB)

Time Correlation Resolution	2 ns
-----------------------------	------

Port In/Out

Connectors	BNC
------------	-----

Mainframe Specifications and Characteristics

Agilent 16700 Series Technical Information (continued)

Port In

Levels	TTL, ECL, or user defined
Input Resistance	4 K Ω
Input Voltage	-6V at -1.5 mA to +6V at 1.6 mA

Port Out

Levels	3V TTL compatible into 50 Ω
Functions	Latched (latch operation is module dependent) Pulsed, width from 66 ns to 143 ns

Target Control Port

Number of signals	8
Levels	3V TTL compatible
Connector	2 rows of 5 pins, 0.1-inch centers

Operating Environment

Temperature	
• Instrument	0°C to 50°C (32°F to 122°F)
• Disk Media	10°C to 40°C (50°F to 104°F)
• Probes/Cables	0°C to 65°C (32°F to 149°F)
Altitude	To 3000m (10,000 ft)
Humidity	8 to 80% relative humidity at 40°C (104°F)

Printing

Printer Interface	Parallel interface for Centronics compatible printers
Printers Supported	PostScript printers and printers which support the HP Printer Control Language (PCL)
Graphics	Graphics can be printed directly to the printer or to a file. Graphic files can be created in black-and-white or color TIFF format, PostScript, PCX, or XWD formats

Mainframe Specifications and Characteristics

Remote Programming Interface (RPI)

RPI Overview

Typical Applications	Manufacturing Test Data Acquisition for Offline Analysis System Verification and Characterization Pass/Fail Analysis Stimulus Response Tests
Remote Programming Steps	1. Set up the logic analyzer and save the test configuration. 2. Create a program that remotely: Loads a test configuration Starts the acquisition process Checks measurement status (verifies completion) Acts on the results of the data acquisition <ul style="list-style-type: none">• Saves configuration and captured data• Exports data• Executes a compare• Modifies the trigger setup or trigger value for the next acquisition• Accesses the oscilloscope's automatic measurements
Physical Connection	Remote programming is done via the LAN connection

Requirements

16700B Series Analysis Systems	RPI is standard with system software version A.02.00.00 or higher
PC	Programming is done via Microsoft® ActiveX/COM automation Pentium (family) PC with one of the following: <ul style="list-style-type: none">• Windows 95• Windows 98• Windows NT 4.0 with Service Pack 3 or higher Visual Basic or Visual C++ (Version 5.0 or higher)
UNIX®	Programming is done via TCP/IP socket based ASCII commands

Mainframe Specifications and Characteristics

Remote Programming Interface (RPI) (continued)

Command Set Summary - Commands available on both UNIX and PC

System	System Configuration Query Load/Save Configuration and Data Start/Stop Measurement Current Run Status Start/Stop/Query a Session
Logic Analysis Modules	Load/Save Configuration and Data Trigger Setup Acquisition Data and Parameters Set/Query Acquisition Mode Set/Query Acquisition Depth Set/Query Pod Assignment Add/Delete/Load/Query Labels Set/Query Trigger Position Modify Occurrence Count
Oscilloscope Modules	Load/Save Configuration and Data Acquisition Data / Parameters Query Automatic Measurements Trigger Setup
Pattern Generator	Load/Save Configuration and Data Load ASCII file (vectors) or PGB (pattern generator binary) files (16720A only) Modify Vector Set/Query Clock Frequency Set/Query Clock Out Delay Insert New Vector at Specific Position Delete Specific Vector
Emulation Module	Reset Processor Run Processor Break Processor Single Step
Listing Tool	Status Acquisition Data and Parameters Transfer Data (includes inverse assembled information)
Compare Tool	Execute Compare Set Compare Mask Query Compare Result Specify Range to Compare Abort Compare After Specified Number of Differences Return Labels and Values Where Differences Occur
File Out Tool	Transfer Data to File Select Range to Expert
Additional Information	
Instrument Online Help	Programming Information in instrument online help
Web Sites	Full remote programming documentation (pdf) available on the hard drive. Sample programs are provided

Mainframe Specifications and Characteristics

IntuiLink

Programming Examples Provided with IntuiLink

Visual Basic	Examples have been included for use with Visual Basic 5.0 or higher. These examples perform simple functions such as: system checks, oscilloscope measurements, pass/fail tests using stored configuration and pattern generator stimulus files, and stimulus/response tests. They also can capture and retrieve data for off-line analysis.
Visual C++	Examples have been included for use with Visual C++ 5.0 or higher to perform simple functions such as: system check, capturing and retrieving data for off-line analysis.
LabVIEW	<p>An instrument library has been included for use with LabVIEW 5.1 or higher. This library contains five LabVIEW samples that provide a starting point for creating your own LabVIEW programs.</p> <ul style="list-style-type: none">• Load/Run/Save - loads a configuration, runs a measurement, then saves results to a file• Analyzer Listing - runs the logic analyzer and displays data in a table• Pass/Fail - runs the logic analyzer and compares the measurement data against a standard• Scope Waveform - runs the oscilloscope module and displays waveform data• Scope Measurements - runs the oscilloscope module and displays a number of oscilloscope measurements
HP VEE	<p>An instrument library has been included for use with HP VEE 5.0 or higher that provides a starting point for creating your own application.</p> <ul style="list-style-type: none">• Load/Run/Save - loads a configuration, runs a measurement, then saves results to a file

Mainframe Specifications and Characteristics

Agilent 16700B Series Physical Characteristics

Power

16700B	115/230 V, 48 to 66 Hz, 610 W max
16701B	115/230 V, 48 to 66 Hz, 545 W max
16702B	115/230 V, 48 to 66 Hz, 610 W max

Weight*

	Max Net	Max Shipping
16700B (lbs)	12.7 kg (27.0 lb)	34.2 kg (75.4 lbs)
16701B (lbs)	10.4 kg (23.0 lb)	32.0 kg (70.6 lbs)
16702B (lbs)	15.2 kg (32.4 lb)	36.7 kg (80.8 lbs)

* Weight of modules ordered with mainframes will add 0.9 kg (2.0 lb) per module.

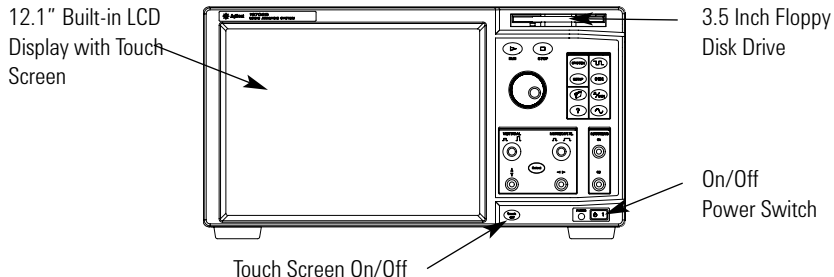

Figure 6.1. Agilent 16702B front panel.

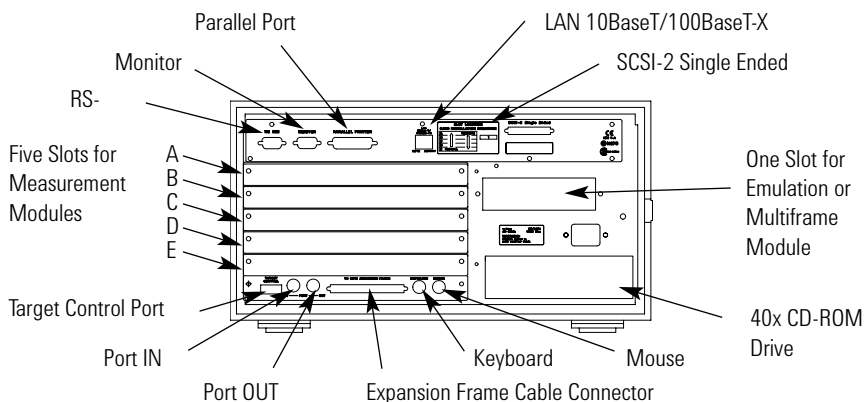

Figure 6.2. Back panel for Agilent models 16700B and 16702B.

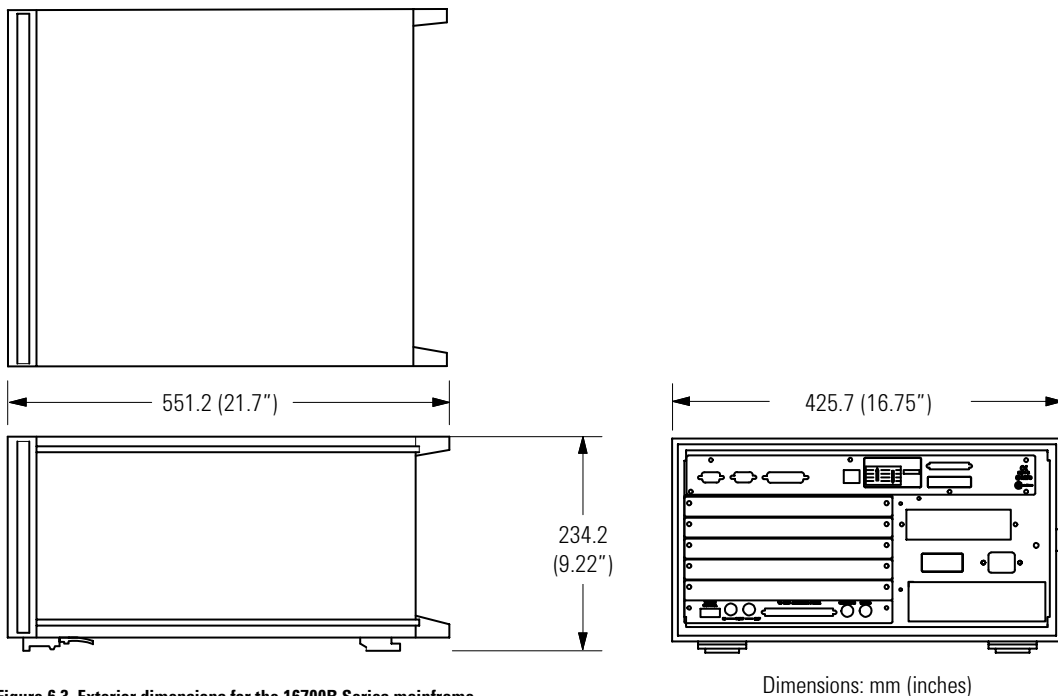

Figure 6.3. Exterior dimensions for the 16700B Series mainframe.

Dimensions: mm (inches)

Mainframe Specifications and Characteristics

Agilent 16700A Series Physical Characteristics

Power

16700A	115/230 V, 48 to 66 Hz, 610 W max
16701A	115/230 V, 48 to 66 Hz, 545 W max
16702A	115/230 V, 48 to 66 Hz, 610 W max

Weight*

	Max Net	Max Shipping
16700A	12.7 kg (27.0 lb)	34.2 kg (75.4 lbs)
16701A	10.4 kg (23.0 lb)	32.0 kg (70.6 lbs)
16702A	15.2 kg (32.4 lb)	36.7 kg (80.8 lbs)

* Weight of modules ordered with mainframes will add 0.9 kg (2.0 lb) per module.

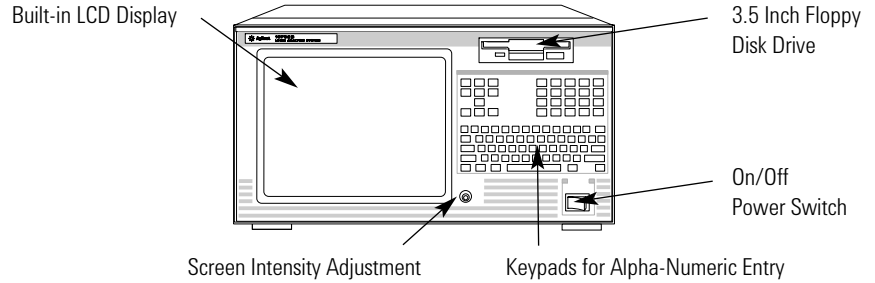

Figure 6.4. Agilent 16702A front panel.

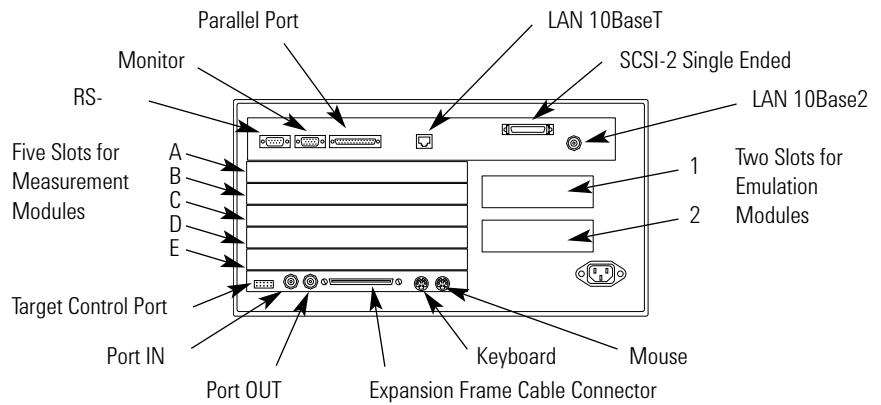
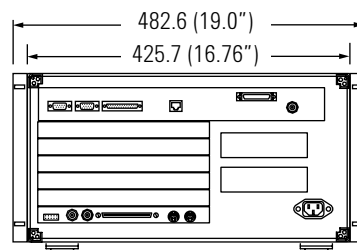
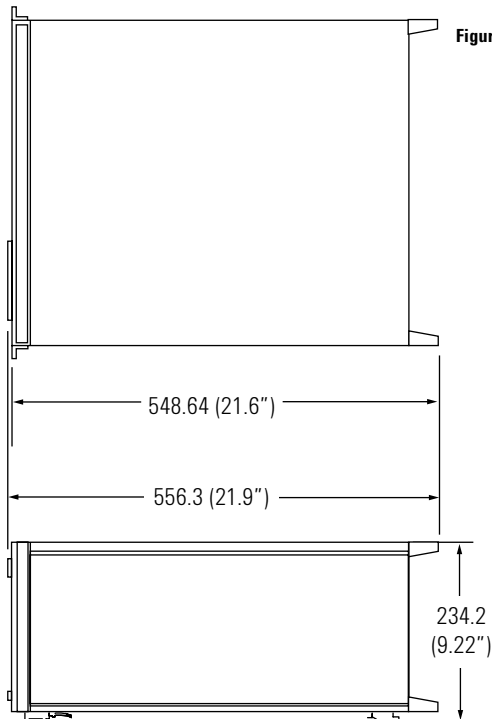

Figure 6.5. Back panel for Agilent models 16700A and 16702A.



Dimensions: mm (inches)

Figure 6.6. Exterior dimensions for the 16700A Series mainframe.

Probing Solutions Specifications and Characteristics

Probing Technical Specifications

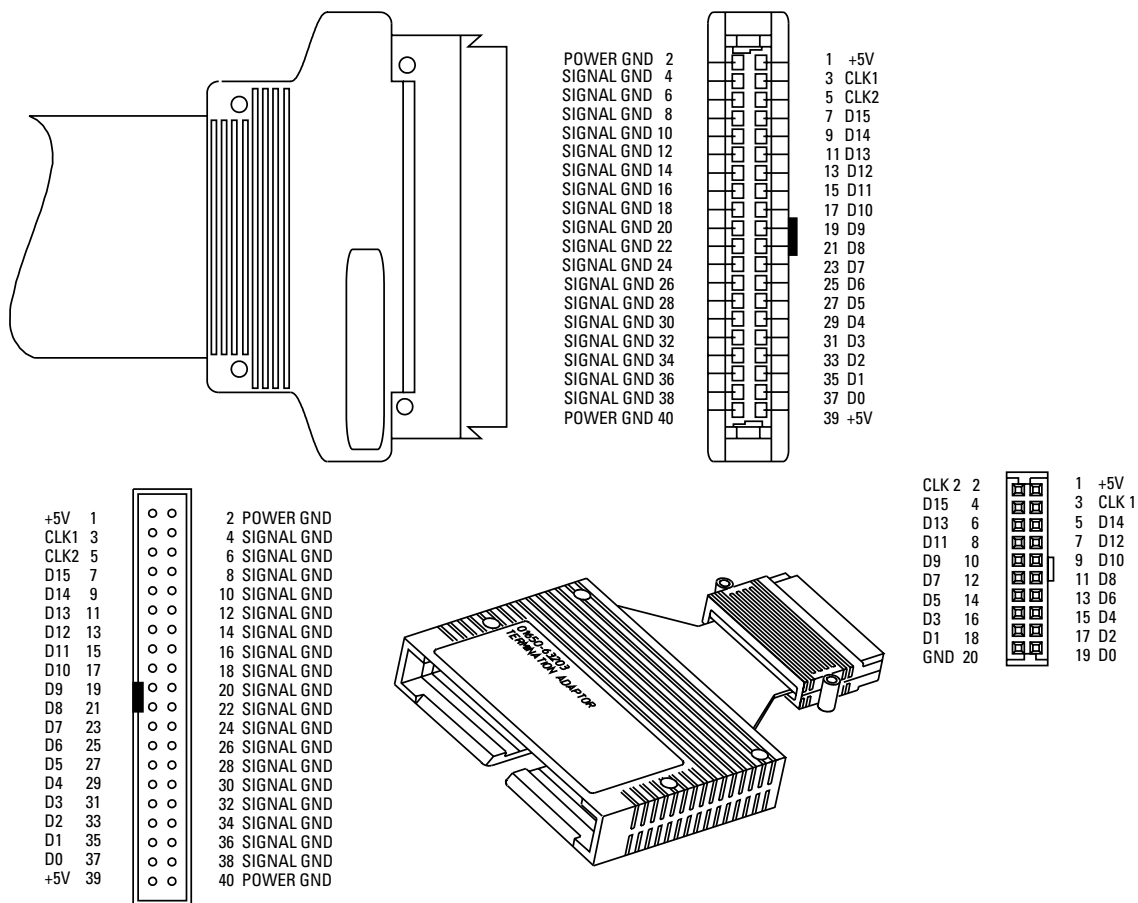

Figure 6.7. Pinout for state/timing module pod cable and 100 KΩ isolation adapter. (Agilent 01650-63203)

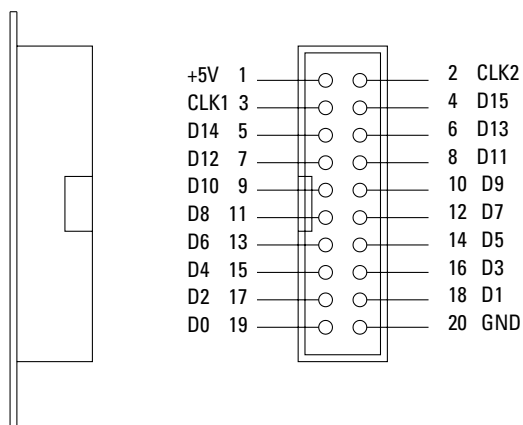

Figure 6.8. Pinout for 20-pin connector. (Agilent 1251-8106)

Probing Solutions Specifications and Characteristics

Isolation Adapter 01650-63203

Isolation adapters that connect to the end of the probe cable are designed to perform two functions. The first is to reduce the number of pins required for the header on the target board from 40 pins to 20 pins. This process reduces the board area dedicated to the probing connection. The second function is to provide the proper RC isolation networks in a very convenient package.

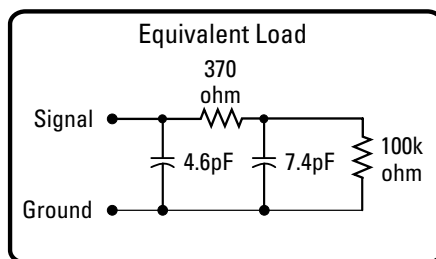
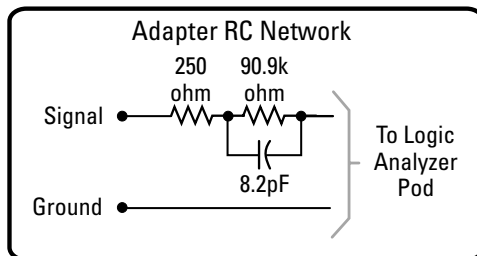

Figure 6.9. Termination adapter and equivalent load.

E5346A 38-pin Probe

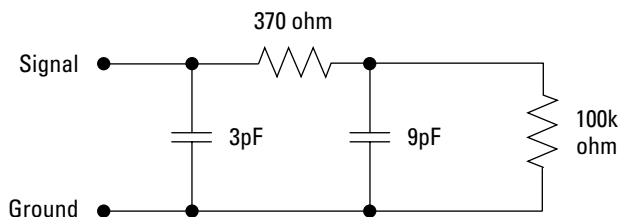

Figure 6.10. E5346A equivalent load.

E5339A 38-pin Low Voltage Probe

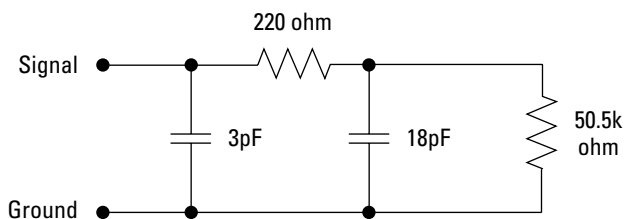

Figure 6.11. E5339A equivalent load.

State/Timing Modules Specifications and Characteristics

Key Specifications* and Characteristics

Agilent Model Number	16715A, 16716A, 16717A	16740A, 16741A, 16742A	16750A, 16751A, 16752A	16760A
Maximum state acquisition rate on each channel	16715A, 16716A: 167 Mb/s 16717A, 333 Mb/s [1]	200 Mb/s	400 Mb/s [1]	Full channel: 800 Mb/s Half channel: 1.25 Gb/s
Maximum timing sample rate (half/full channel)	Timing Zoom: 2 GHz (16716A, 16717A only) Conventional: 667/333 MHz Transitional: 333 MHz	Timing Zoom: 2 GHz Conventional: 800/400 MHz Transitional: 400 MHz	Timing Zoom: 2 GHz Conventional: 800/400 MHz Transitional: 400 MHz	Conventional: 800 MHz Transitional: 400 MHz
Channels/module	68	68	68	34
Maximum channels on a single time base and trigger	340 (5 modules)	340 (5 modules)	340 (5 modules)	170 (5 modules)
Memory depth (half/full channel)	16715A, 16717A: 4/2M [2] 16716A: 1M/512K [2]	16740A: 2/1 M [2] 16741A: 8/4 M [2] 16742A 32/16 M [2]	16750A: 8/4M [2] 16751A: 32/16M [2] 16752A: 64/32M [2]	128/64M [5]
Trigger resources 16750A,	Patterns: 16 Ranges: 15 Edge & Glitch: 2 Timers: (2 per module) -1 Occurrence Counter: [4] Global Counters: 2 Flags: 4	Pattern: 16 Ranges: 15 Edge & Glitch: 2 Timers: (2 per module) -1 Occurrence Counter: 2 Global Counter: 2 Flags: 4	Patterns: 16 Ranges: 15 Edge & Glitch: 2 Timers: (2 per module) -1 Occurrence Counter: [4] Global Counters: 2 Flags: 4	At 800 Mb/s: 4 patterns or 2 ranges, 4 flags, arm in At 200 Mb/s: same as 16751A, 16752A Other speeds: refer to synchronous state analysis (page 98) and asynchronous timing analysis (page 100)
Maximum trigger sequence levels	16	16	16	1.25 Gb/s: 2 800 Mb/s: 4 200 or 400 Mb/s: 16
Maximum trigger sequence speed	16715A, 16716A: 167 MHz 16717A: 333 MHz	200 MHz	400 MHz	1.25 Gb/s
Trigger sequence level branching	4-way arbitrary "IF/THEN/ELSE" branching	4-way arbitrary "IF/THEN/ELSE" branching	4-way arbitrary "IF/THEN/ELSE" branching	800 or 1.25 Gb/s: none 200 Mb/s: arbitrary "IF/THEN/ELSE" branching 400 Mb/s: dedicated next-state branch or reset
Number of state clocks/qualifiers	4	4	4	1 (state clock only)
Setup/hold time*	2.5 ns window adjustable from 4.5/-2.0 ns to -2.0/4.5 ns in 100 ps increments per channel [3]	2.5 ns windows adjustable from 4.5/2.0 ns to -2.0/4.5 ns in 100 ps increments per channel [3]	2.5 ns window adjustable from 4.5/-2.0 ns to -2.0/4.5 ns in 100 ps increments per channel [3]	1 ns window adjustable from 2.5/-1.5 ns to -1.5/2.5 ns 10 ps increments per channel
Threshold range	TTL, ECL, user-definable ± 6.0 V adjustable in 10-mV increments	TTL, ECL, user-definable ± 6.0 V adjustable in 10-mV increments	TTL, ECL, user-definable ± 6.0 V adjustable in 10-mV increments	-3.0 V to 5.0 V adjustable in 10-mV increments

* All specifications noted by an asterisk are the performance standards against which the product is tested.

[1] State speeds greater than 167 MHz (16717A) or 200 MHz (16750A, 16751A, 16752A, 16760A) require a trade-off in features.

Refer to "Supplemental Specifications and Characteristics" on page 93 for more information.

[2] Memory depth doubles in half-channel timing mode only.

[3] Minimum setup/hold time specified for a single clock, single edge acquisition. Multi-clock, multi-edge setup/hold window add 0.5 ns.

[4] There is one occurrence counter per trigger sequence level.

[5] Memory depth doubles in half-channel 1.25 Gb/s state mode only.

State/Timing Modules Specifications and Characteristics

Key Specifications* and Characteristics (continued)

Agilent Model Number	16710A, 16711A, 16712A
Maximum state acquisition rate on each channel	100 Mb/s
Maximum timing sample rate (half/full channel)	Conventional: 500/250 MHz Transitional: 125 MHz
Channels/module	102
Maximum channel count on a single time base and trigger	204 (2 modules)
Memory depth (half/full channel)	16710A: 16/8K [1] 16711A: 64/32K [1] 16712A: 256/128k [1]
Trigger resources	Patterns: 10 Ranges: 2 Edge & Glitch: 2 Timers: 2
Maximum trigger sequence levels	State mode: 12 Timing mode: 10
Maximum trigger sequence speed	125 MHz
Trigger sequence level branching	Dedicated next state or single arbitrary branching
Number of state clocks/qualifiers	6
Setup/hold time*	4.0 ns window adjustable from 4.0/0 ns to 0/4.0 ns in 500 ps increments [2] per 34 channels
Threshold range	TTL, ECL, user-definable ± 6.0 V adjustable in 50 mV increments

* All specifications noted by an asterisk are the performance standards against which the product is tested.

[1] Memory depth doubles in half-channel timing mode only.

[2] Minimum setup/hold time specified for single-clock, single-edge acquisition. Single-clock, multi-edge setup/hold add 0.5 ns. Multi-clock, multi-edge setup/hold window add 1.0 ns.

State/Timing Modules Specifications and Characteristics

Agilent Technologies 16710A, 16711A, 16712A Supplemental Specifications* and Characteristics

Probes (general-purpose lead set)

Input resistance	100 K Ω , $\pm 2\%$
Parasitic tip capacitance	1.5 pF
Minimum voltage swing	500 mV, peak-to-peak
Threshold accuracy*	$\pm(100 \text{ mV} + 3\% \text{ of threshold setting})$
Maximum input voltage	$\pm 40 \text{ V peak}$

State Analysis

Minimum state clock pulse width	3.5 ns
Time tag resolution [1]	8 ns
Maximum time count between states	34 seconds
Maximum state tag count between states [1]	4.29×10^9 states
Minimum master to master clock time*	16710A, 16711A, 16712A: 10 ns
Minimum master to slave clock time	0.0 ns
Minimum slave to master clock time	4.0 ns
Context store block sizes 16710A/11A/12A only	16, 32, 64 states

Timing Analysis

Sample period accuracy	0.01% of sample period
Channel-to-channel skew	2 ns, typical
Time interval accuracy	$\pm (\text{sample period} + \text{channel-to-channel skew} + 0.01\% \text{ of time interval reading})$
Minimum detectable glitch	3.5 ns

* All specifications noted by an asterisk are the performance standards against which the product is tested.
[1] Time or state tags halve the acquisition memory when there are no unassigned pods.

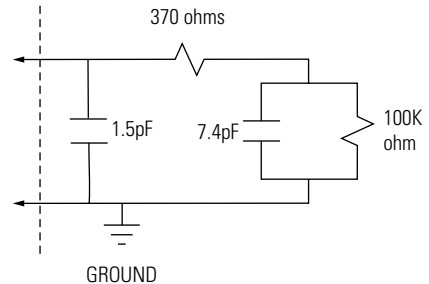

Figure 6.12. Equivalent probe load for the Agilent 16710A, 16711A and 16712A, general-purpose lead set.

State/Timing Modules Specifications and Characteristics

Agilent Technologies 16710A, 16711A, 16712A Supplemental Specifications* and Characteristics (continued)

Triggering

Maximum trigger sequence speed	125 MHz, maximum
Maximum occurrence counter	1,048,575
Range width	32 bits each
Timer value range	400 ns to 500 seconds
Timer resolution	16 ns or 0.1% whichever is greater
Timer accuracy	±32 ns or ±0.1% whichever is greater

Operating Environment

Temperature	Agilent 16700 Series mainframes: <ul style="list-style-type: none">• Instrument 0°C to 50°C (+32°F to 122°F)• Probe lead sets and cables, 0°C to 65°C (+32°F to 149°F)
Humidity	80% relative humidity at +40°C
Altitude	Operating 4600m (15,000ft) Nonoperating 15,300m (50,000ft)

* All specifications noted by an asterisk are the performance standards against which the product is tested.

State/Timing Modules Specifications and Characteristics

Agilent Technologies 16715A, 16716A, 16717A, 16740A, 16741A, 16742A, 16750A, 16751A, 16752A Supplemental Specifications* and Characteristics

Probes (general-purpose lead set)

Input resistance	100 K Ω , \pm 2%
Parasitic tip capacitance	1.5 pF
Minimum voltage swing	500 mV, peak-to-peak
Minimum input overdrive	250 mV
Threshold range	-6V to +6V in 10 mV increments
Threshold accuracy*	\pm (65 mV + 1.5% of settings)
Input dynamic range	\pm 10V about threshold
Maximum input voltage	\pm 40V peak
+5V Accessory current	1/3 amp maximum per pod
Channel assignment	Each group of 34 channels can be assigned to Analyzer 1, Analyzer 2 or remain unassigned

2 GHz Timing Zoom (Agilent 16716A, 16717A, 16740A, 16741A, 16742A, 16750A, 16751A, 16752A only)

Timing analysis sample rate	2 GHz/1 GHz/500 MHz/250 MHz
Sample period accuracy	\pm 50 ps
Channel-to-channel skew	< 1.0 ns
Time interval accuracy	\pm (sample period + channel-to-channel skew + 0.01% of time interval reading)
Memory depth	16 K
Trigger position	Start, center, end, or user defined

Operating Environment

Temperature	Agilent 16700 Series frame: 0 $^{\circ}$ C to 50 $^{\circ}$ C (+32 $^{\circ}$ F to 122 $^{\circ}$ F) Probe lead sets and cables: 0 $^{\circ}$ C to 65 $^{\circ}$ C (+32 $^{\circ}$ F to 149 $^{\circ}$ F)
Humidity	80% relative humidity at + 40 $^{\circ}$ C
Altitude	Operating 4600 m (15,000 ft) Non-operating 15,300 m (50,000 ft)

* All specifications noted by an asterisk are the performance standards against which the product is tested.

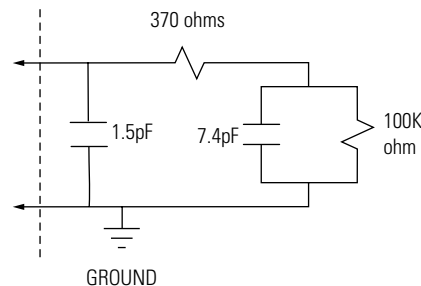

Figure 6.13. Equivalent probe load for the Agilent 16715A, 16716A, 16717A, 16718A, 16719A, 16750A, 16751A, 16752A general-purpose lead set.

State/Timing Modules Specifications and Characteristics

Agilent Technologies 16715A, 16716A, 16717A, 16740A, 16741A, 16742A, 16750A, 16751A, 16752A Supplemental Specifications* and Characteristics

State Mode	16715A, 16716A, 16717A 167 Mb/s State Mode	16740A, 16741A, 16742A 16750A, 16751A, 16752A 200 Mb/s State Mode
Maximum state acquisition rate on each channel	167 Mb/s	200 Mb/s
Channel count	68 per module	68 per module
Maximum channels on a single time base and trigger	340	340
Number of independent analyzers	2, can be set up in state or timing modes	2, can be set up in state or timing modes
Minimum master to master clock time* [1]	5.988 ns	5 ns
Minimum master to slave clock time	2 ns	2 ns
Minimum slave to master clock time	2 ns	2 ns
Minimum slave to slave clock time	5.988 ns	5 ns
Setup/hold time* [1] (single-clock, single-edge)	2.5 ns window adjustable from 4.5/-2.0 ns to -2.0/4.5 ns in 100 ps increments per channel	2.5 ns window adjustable from 4.5/-2.0 ns to -2.0/4.5 ns in 100 ps increments per channel
Setup/hold time* [1] (multi-clock, multi-edge)	3.0 ns window adjustable from 5.0/-2.0 ns to -1.5/4.5 ns in 100 ps increments per channel	3.0 ns window adjustable from 5.0/-2.0 ns to -1.5/4.5 ns in 100 ps increments per channel
Setup/hold time (on individual channels, after running eye finder)	1.25 ns window	1.25 ns window
Minimum state clock pulse width	1.2 ns	1.2 ns
Time tag resolution [2]	4 ns	4 ns
Maximum time count between states	17 seconds	17 seconds
Maximum state tag count between states [2]	2 ³²	2 ³²
Number of state clocks/qualifiers	4	4
Maximum memory depth	16716A: 512K 16715A, 16717A: 2M	16740A: 1M 16741A: 4M 16742A: 16M 16750A: 4M 16751A: 16M 16752A: 32M
Maximum trigger sequence speed	167 MHz	200 MHz
Maximum trigger sequence levels	16	16

* All specifications noted by an asterisk are the performance standards against which the product is tested.

[1] Tested at input signal VH=-0.9V, VL=-1.7V, Slew rate=1V/ns, and threshold=-1.3V.

[2] Time or state tags halve the acquisition memory when there are no unassigned pods.

State/Timing Modules Specifications and Characteristics

Agilent Technologies 16715A, 16716A, 16717A, 16740A, 16741A, 16742A, 16750A, 16751A, 16752A Supplemental Specifications* and Characteristics (continued)

State Mode	16715A, 16716A, 16717A 167 Mb/s State Mode	16740A, 16741A, 16742A 16750A, 16751A, 16752A 200 Mb/s State Mode
Trigger sequence level branching	4 way arbitrary "IF/THEN/ELSE" branching	4 way arbitrary "IF/THEN/ELSE" branching
Trigger position	Start, center, end, or user defined	Start, center, end, or user defined
Trigger resources	16 Patterns evaluated as =, ≠, >, <, ≥, ≤ 15 Ranges evaluated as in range, not in range (2 Timers per module) -1 2 Global counters 1 Occurrence counter per sequence level 4 Flags	16 Patterns evaluated as =, ≠, >, <, ≥, ≤ 15 Ranges evaluated as in range, not in range (2 Timers per module) -1 2 Global counters 1 Occurrence counter per sequence level 4 Flags
Trigger resource conditions	Arbitrary Boolean combinations	Arbitrary Boolean combinations
Trigger actions	Goto Trigger and fill memory Trigger and goto Store/don't store sample Turn on/off default storing Timer start/stop/pause/resume Global counter increment/reset Occurrence counter reset Flag set/clear	Goto Trigger and fill memory Trigger and goto Store/don't store sample Turn on/off default storing Timer start/stop/pause/resume Global counter increment/reset Occurrence counter reset Flag set/clear
Store qualification	Default and per sequence level	Default and per sequence level
Maximum global counter	16,777,215	16,777,215
Maximum occurrence counter	16,777,215	16,777,215
Maximum pattern/range width	32 bits	32 bits
Timers value range	100 ns to 5497 seconds	100 ns to 5497 seconds
Timer resolution	5 ns	5 ns
Timer accuracy	10 ns + .01%	10 ns + .01%
Timer reset latency	70 ns	70 ns
Data in to trigger out (BNC port)	150 ns, typical	150 ns, typical
Flag set/reset to evaluation	110 ns, typical	110 ns, typical

* All specifications noted by an asterisk are the performance standards against which the product is tested.

State/Timing Modules Specifications and Characteristics

Agilent Technologies 16715A, 16716A, 16717A, 16740A, 16741A, 16742A, 16750A, 16751A, 16752A Supplemental Specifications* and Characteristics (continued)

State Mode	16715A, 16716A, 16717A 167 Mb/s State Mode	16750A, 16751A, 16752A 400 Mb/s State Mode
Maximum state acquisition rate on each channel	333 Mb/s	400 Mb/s
Channel count	(Number of modules x 68) - 34	(Number of modules x 68) - 34
Maximum channels on a single time base and trigger	306	306
Number of independent analyzers	1, when 333 MHz state mode is selected the second analyzer is turned off	1, when 400 MHz state mode is selected the second analyzer is turned off
Minimum master to master clock time* [1]	3.003 ns	2.5 ns
Setup/hold time* [1] (single-clock, single-edge)	2.5 ns window adjustable from 4.5/-2.0 ns to -2.0/4.5 ns in 100 ps increments per channel	2.5 ns window adjustable from 4.5/-2.0 ns to -2.0/4.5 ns in 100 ps increments per channel
Setup/hold time* [1] (single-clock, multi-edge)	3.0 ns window adjustable from 5.0/-2.0 ns to -1.5/4.5 ns in 100 ps increments per channel	3.0 ns window adjustable from 5.0/-2.0 ns to -1.5/4.5 ns in 100 ps increments per channel
Setup/hold time (on individual channels after running eye finder)	1.25 ns window	1.25 ns window
Minimum state clock pulse width	1.2 ns	1.2 ns
Time tag resolution [2]	4 ns	4 ns
Maximum time count between states	17 seconds	17 seconds
Number of state clocks	1	1
Maximum memory depth	16717A: 2M	16750A: 4M 16751A: 16M 16752A: 32M
Maximum trigger sequence speed	333 MHz	400 MHz
Maximum trigger sequence levels	15	15
Trigger sequence level branching	Dedicated next state branch or reset	Dedicated next state branch or reset
Trigger position	Start, center, end, or user defined	Start, center, end, or user defined

* All specifications noted by an asterisk are the performance standards against which the product is tested.

[1] Tested at input signal VH=-0.9V, VL=-1.7V, Slew rate=1V/ns, and threshold=-1.3V.

[2] Time or state tags halve the acquisition memory when there are no unassigned pods.

State/Timing Modules Specifications and Characteristics

Agilent Technologies 16715A, 16716A, 16717A, 16740A, 16741A, 16742A, 16750A, 16751A, 16752A Supplemental Specifications* and Characteristics (continued)

State Mode	16715A, 16716A, 16717A 167 Mb/s State Mode	16750A, 16751A, 16752A 400 Mb/s State Mode
Trigger resources	8 Patterns evaluated as =, ≠, >, <, ≥, ≤ 4 Ranges evaluated as in range, not in range 2 Occurrence counters 4 Flags	8 Patterns evaluated as =, ≠, >, <, ≥, ≤ 4 Ranges evaluated as in range, not in range 2 Occurrence counters 4 Flags
Trigger resource conditions	Arbitrary Boolean combinations	Arbitrary Boolean combinations
Trigger actions	Goto Trigger and fill memory	Goto Trigger and fill memory
Store qualification	Default	Default
Maximum occurrence counter	16,777,215	16,777,215
Maximum pattern/range width	32 bits	32 bits
Data in to trigger out (BNC port)	150 ns, typical	150 ns, typical
Flag set/reset to evaluation	110 ns, typical	110 ns, typical
Timing Mode	16715A, 16716A, 16717A	16740A, 16741A, 16742A, 16750A, 16751A, 16752A
Timing analysis sample rate (half/full channel)	667/333 MHz	800/400 MHz
Channel count	68 per module	68 per module
Maximum channels on a single time base and trigger	340	340
Number of independent analyzers	2, can be setup in state or timing modes	2, can be setup in state or timing modes
Sample period (full channel)	3 ns to 1 ms	2.5 ns to 1 ms
Sample period (half channel)	1.5 ns	1.25 ns
Minimum data pulse width for data capture		
Conventional timing	1.75 ns	1.5 ns
Transitional timing	3.9 ns	3.8 ns
For trigger sequencing	6.1 ns	5.1 ns
Sample period accuracy	±(100 ps + .01% of sample period)	±(100 ps + .01% of sample period)
Channel-to-channel skew	< 1.5 ns	< 1.5 ns
Time interval accuracy	± (sample period + channel-to-channel skew + .01% of time interval reading)	± (sample period + channel-to-channel skew + .01% of time interval reading)
Minimum detectable glitch	1.5 ns	1.5 ns
Memory depth (half/full channel)	16716A: 1M/512K 16715A, 16717A: 4/2M	16750A: 8/4M 16751A: 32/16M 16752A: 64/32M

* All specifications noted by an asterisk are the performance standards against which the product is tested.

State/Timing Modules Specifications and Characteristics

Agilent Technologies 16715A, 16716A, 16717A, 16740A, 16741A, 16742A, 16750A, 16751A, 16752A Supplemental Specifications* and Characteristics (continued)

Timing Mode (continued)	16715A, 16716A, 16717A	16740A, 16741A, 16742A 16750A, 16751A, 16752A
Maximum trigger sequence speed	167 MHz	200 MHz
Maximum trigger sequence levels	16	16
Trigger sequence level branching	4 way arbitrary "IF/THEN/ELSE" branching	4 way arbitrary "IF/THEN/ELSE" branching
Trigger position	Start, center, end, or user defined	Start, center, end, or user defined
Trigger resources	16 Patterns evaluated as =, ≠, >, <, ≥, ≤ 15 Ranges evaluated as in range, not in range 2 Edge/glitch (2 Timers per module) -1 2 Global counters 1 Occurrence counter per sequence level 4 Flags	16 Patterns evaluated as =, ≠, >, <, ≥, ≤ 15 Ranges evaluated as in range, not in range 2 Edge/glitch (2 Timers per module) -1 2 Global counters 1 Occurrence counter per sequence level 4 Flags
Trigger resource conditions	Arbitrary Boolean combinations	Arbitrary Boolean combinations
Trigger actions	Goto Trigger and fill memory Trigger and goto Timer start/stop/pause/resume Global counter increment/reset Occurrence counter reset Flag set/clear	Goto Trigger and fill memory Trigger and goto Timer start/stop/pause/resume Global counter increment/reset Occurrence counter reset Flag set/clear
Maximum global counter	16,777,215	16,777,215
Maximum occurrence counter	16,777,215	16,777,215
Maximum pattern/range width	32 bits	32 bits
Timer value range	100 ns to 5497 seconds	100 ns to 5497 seconds
Timer resolution	5 ns	5 ns
Timer accuracy	±10 ns + .01%	±10 ns + .01%
Greater than duration	6 ns to 100 ms in 6 ns increments	6 ns to 100 ms in 6 ns increments
Less than duration	12 ns to 100 ms in 6 ns increments	12 ns to 100 ms in 6 ns increments
Timer reset latency	70 ns	70 ns
Data in to trigger out (BNC port)	150 ns, typical	150 ns, typical
Flag set/reset to evaluation	110 ns, typical	110 ns, typical

* All specifications noted by an asterisk are the performance standards against which the product is tested.

State/Timing Modules Specifications and Characteristics

Agilent Technologies 16760A Supplemental Specifications* and Characteristics

Probes	E5378A Single-ended	E5379A Differential	E5380A Mictor	E5382A Single-Ended Flying Leads
Input resistance and capacitance	Refer to figure 6.14	Refer to figure 6.14	Refer to figure 6.14	Refer to figure 6.15
Maximum state data rate supported	1.5 Gb/s	1.5 Gb/s	600 Mb/s	1.5 Gb/s
Mating connector	Agilent part number 1253-3620 [1]	Agilent part number 1253-3620 [1]	Amp Mictor 38 [2]	None required
Minimum voltage swing	250 mV p-p	$V_{in}^+ - V_{in}^- \geq 200$ mV p-p	300 mV p-p	250 mV p-p
Input dynamic range	-3 Vdc to +5 Vdc	-3 Vdc to +5 Vdc	-3 Vdc to +5 Vdc	-3 Vdc to +5 Vdc
Threshold accuracy	+/- (30 mV + 1% of setting)*	+/- (30 mV + 1% of setting) [3]	+/- (30 mV + 1% of setting)	+/- (30 mV + 1% of setting)
Threshold range	-3.0 V to +5.0 V	-3.0 V to +5.0 V	-3.0 V to +5.0 V	-3.0 V to +5.0 V
User-supplied threshold input range	-3.0 V to +5.0 V	N/A	N/A	N/A
User-supplied threshold input resistance	≥ 100 K ohms	N/A	N/A	N/A
Threshold control options	<ul style="list-style-type: none"> User-provided input Adjustable from user interface 	If operated single-ended (minus inputs grounded), the threshold can be adjusted from the user interface	Adjustable from user interface	Adjustable from user interface
Maximum nondestructive input voltage	+/-40 Vdc	+/-40 Vdc	+/-40 Vdc	+/-40 Vdc
Maximum input slew rate	5 V/ns	5 V/ns	5 V/ns	5 V/ns
Clock input	Differential	Differential	Single-ended	Differential
Number of inputs [4]	34 (32 data and 2 clock/data)	17 (16 data and 1 clock/data)	34 (32 data and 2 clock/data)	17 (16 data and 1 clock/data)

* All specifications noted by an asterisk are the performance standards against which the product is tested.

[1] A support shroud, Agilent part number 16760-02302 (for boards up to 0.062" thick) or 16760-02303 (for boards up to 0.120" thick) is recommended.

A kit of 5 shrouds and 5 connectors is available as Agilent part number 16760-68702 (for boards up to 0.062" thick) or 16760-68703 (for boards up to 0.120" thick).

[2] A kit of 5 Amp Mictor connectors and 5 support shrouds is available, Agilent part number E5346-68701.

A support shroud is available separately, Agilent part number E5346-44701.

[3] If operated single-ended (minus inputs grounded), the threshold can be adjusted from the user interface.

[4] Refer to specifications on specific modes of operation for details on how inputs can be used.

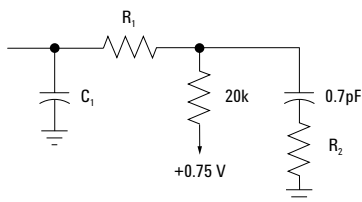

Model Number	C ₁	R ₁	R ₂
E5378A, E5379A	1.5pF	120	30
E5380A	3pF	120	60

Figure 6.14. E5378A, E5379A, E5380A input equivalent probe load.

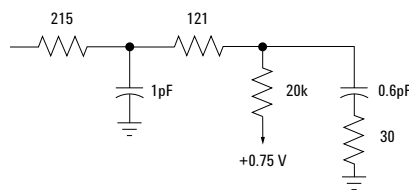

Figure 6.15. E5382A input equivalent probe load, with 5cm damped wire (see user's guide for load models with other accessories).

State/Timing Modules Specifications and Characteristics

Agilent Technologies 16760A Supplemental Specifications* and Characteristics (continued)

Synchronous Data Sampling

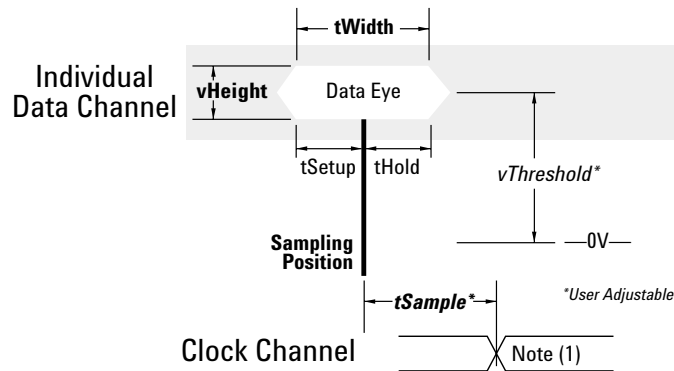

Figure 6.17. Data Sampling.

Specifications for Each Input

Parameter	Minimum		Description/Notes
		800, 1250, 1500 Mb/s modes	200, 400 Mb/s modes
Data to Clock	t_{Width}^* t_{Setup} t_{Hold}	500 ps 250 ps 250 ps	1.25 ns 625 ps 625 ps
All Inputs	v_{Height} [1]	100mV 250 mV 300mV	100mV 250 mV 300mV
			E5379A 100-pin differential probe [3] E5378A 100-pin single-ended probe [4], E5382A single-ended flying-lead probe set E5380A 38-pin single-ended probe

User Adjustable Settings for Each Input

Parameter	Adjustment Range					
		1500 Mb/s mode	1250 Mb/s mode	800 Mb/s mode	400 Mb/s mode	200 Mb/s mode
Data to Clock	Adjustment Resolution t_{Sample} [5]	10 ps 0 to +4 ns	10 ps -2.5 to +2/5 ns	10 ps -2.5 to +2/5 ns	100 ps -3.2 to +3.2 ns	100 ps -3.5 to +3 ns
All Inputs	$v_{Threshold}$ [6]	10 mV resolution -3 to +5 V	10 mV resolution -3 to +5 V	10 mV resolution -3 to +5 V	10 mV resolution -3 to +5 V	10 mV resolution -3 to +5 V

* All specifications noted by an asterisk in the table are the performance standards against which the product is tested.

[1] The analyzer can be configured to sample on the rising edge, the falling edge, or both edges of the clock. If both edges are used with a single ended clock input, take care to set the clock threshold accurately to avoid phase error.

[2] Eye width and height are specified at the probe tip. Eye width as measured by eye finder in the analyzer may be less, and still sample reliably.

[3] For each side of a differential signal.

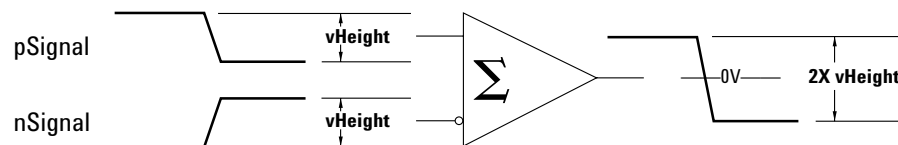

[4] The clock inputs in the E5378A and the E5382A may be connected differentially or single ended. Use the E5379A v_{Height} spec for clock channel(s) connected differentially.

[5] Sample positions are independently adjustable for each data channel input. A negative sample position causes the input to be synchronously sampled by that amount before each active clock edge. A positive sample position causes the input to be synchronously sampled by that amount after each active clock edge. A sampling position of zero causes synchronous sampling coincident with each active clock edge.

[6] Threshold applies to single-ended input signals. Thresholds are independently adjustable for the clock input of each pod and for each set of 16 data inputs for each pod. Threshold limits apply to both the internal reference and to the external reference input on the E5378A.

State/Timing Modules Specifications and Characteristics

Agilent Technologies 16760A Supplemental Specifications* and Characteristics (continued)

Synchronous state analysis	1.5 Gb/s mode	1.25 Gb/s mode	800 Mb/s mode	400 Mb/s mode	200 Mb/s mode
Maximum data rate on each channel	E5378A, E5379A probes: 1.5 Gb/s	E5378A, E5379A probes: 1.25 Gb/s	E5378A, E5379A, E5382A probes: 800 Mb/s E5380A probe: 600 Mb/s	400 Mb/s	200 Mb/s
Minimum clock interval, active edge to active edge*	667 ps	800 ps	E5378A, E5379A probes: 1.25 ns E5380A probe: 1.67 ns	2.5 ns	5 ns
Minimum state clock pulse width with clock polarity rising or falling	N/A	N/A	E5378A, E5379A probes: 600 ps E5380A probe: 800 ps	1.5 ns	1.5 ns
Clock periodicity	Clock must be periodic	Clock must be periodic	Periodic or aperiodic	Periodic or aperiodic	Periodic or aperiodic
Number of clocks	1	1	1	1	1
Clock polarity	Both edges	Both edges	Rising, falling, or both	Rising, falling, or both	Rising, falling, or both
Minimum data pulse width	600 ps	750 ps	E5378A, E5379A, E5382A probes: 750 ps E5380A probe: 1.5 ns	1.5 ns	1.5 ns
Number of channels [1]					
• With time tags	16 x (number of modules) - 8	16 x (number of modules) - 8	34 x (number of modules) - 16	34 x (number of modules) - 16	34 x (number of modules)
• Without time tags	16 x (number of modules)	16 x (number of modules)	34 x (number of modules)	34 x (number of modules)	34 x (number of modules)
Maximum channels on a single time base and trigger	80 (5 modules)	80 (5 modules)	170 (5 modules)	153 (5 modules)	170 (5 modules)
Maximum memory depth	128M samples	128M samples	64M samples	32M samples	32M samples
Time tag resolution	4 ns [2]	4 ns [2]	4 ns [2]	4 ns [2]	4 ns
Maximum time count between states	17 seconds	17 seconds	17 seconds	17 seconds	17 seconds
Trigger resources	3 Patterns on each pod evaluated as =, ≠, >, <, ≥, ≤ on one pod; or evaluated as =, ≠ across multiple pods; or 1 range on each pod 4 Flags Arm in	3 Patterns on each pod evaluated as =, ≠, >, <, ≥, ≤ on one pod; or evaluated as =, ≠ across multiple pods; or 1 range on each pod 4 Flags Arm in	4 Patterns on each pod evaluated as =, ≠, >, <, ≥, ≤ on one pod; or evaluated as =, ≠ across multiple pods; or 2 ranges on each pod 4 Flags Arm in	8 Patterns evaluated as =, ≠, >, <, ≥, ≤ 4 Ranges evaluated as in range, not in range 2 Occurrence counters 4 Flags Arm in	16 Patterns evaluated as =, ≠, >, <, ≥, ≤ 15 Ranges evaluated as in range, not in range Timers: 2 x (number of modules) - 1 2 Global counters 1 Occurrence counter per sequence level 4 Flags Arm in
Trigger actions	Trigger and fill memory	Trigger and fill memory	Trigger and fill memory	Goto Trigger and fill memory	Goto Trigger and fill memory Trigger and goto Store/don't store sample Turn default storing on/off Timer start/stop/pause/resume Global counter increment/reset Occurrence counter reset Flag set/clear

* All specifications noted by an asterisk are the performance standards against which the product is tested.

[1] In 1.25 Gb/s mode, only the even-numbered channels (0, 2, 4, etc.) are acquired.

[2] The resolution of the hardware used to assign time tags is 4 ns. Times of intermediate states are calculated.

State/Timing Modules Specifications and Characteristics

Agilent Technologies 16760A Supplemental Specifications and Characteristics (continued)

Synchronous state analysis (continued)	1.5 Gb/s mode (only available with E5378A and E5379A probes)	1.25 Gb/s mode (only available with E5378A and E5379A probes)	800 Mb/s mode	400 Mb/s mode	200 Mb/s mode
Maximum trigger sequence levels	2	2	4	16	16
Maximum trigger sequencer speed	1.5 Gb/s	1.25 Gb/s	800 MHz	400 MHz	200 MHz
Store qualification	Default	Default	Default	Default	Default and per sequence level
Maximum global counter	N/A	N/A	N/A	N/A	16,777,215
Maximum occurrence counter	N/A	N/A	N/A	N/A	16,777,215
Maximum pattern/range term width	32 bits [3]	32 bits [3]	32 bits [3]	32 bits [3]	32 bits [3]
Timer value range	N/A	N/A	N/A	N/A	100 ns to 4397 seconds
Timer resolution	N/A	N/A	N/A	N/A	4 ns
Timer accuracy	N/A	N/A	N/A	N/A	±(10 ns + 0.01% of value)
Timer reset latency	N/A	N/A	N/A	N/A	65 ns
Data in to BNC port out latency	150 ns	150 ns	150 ns	150 ns	150 ns
Flag set/reset to evaluation latency	N/A	N/A	N/A	N/A	110 ns

[1] In 1.25 Gb/s mode, only the even-numbered channels (0, 2, 4, etc.) are acquired.

[2] The resolution of the hardware used to assign time tags is 4 ns. Times of intermediate states are calculated.

[3] Maximum label width is 32 bits. Wider patterns can be created by "Anding" multiple labels together.

Asynchronous Timing Analysis	Conventional Timing Analysis	Transitional Timing Analysis
Maximum timing analysis sample rate	800 MHz	400 MHz
Number of channels	34 x (number of modules)	Sampling rates < 400 MHz: 34 x (number of modules) Sampling rates = 400 MHz: 34 x (number of modules) - 17 [1]
Maximum channels on a single time base and trigger	170 (5 modules)	170 (5 modules)
Sample period	1.25 ns	2.5 ns to 1 ms [1]
Memory Depth	64 M Samples	32 M Samples [1]

[1] With all pods assigned in transitional/store qualified timing, minimum sample period is 5 ns and maximum memory depth is 16 M samples.

State/Timing Modules Specifications and Characteristics

Agilent Technologies 16760A Supplemental Specifications and Characteristics (continued)

Asynchronous Timing Analysis (continued)	Conventional Timing Analysis	Transitional Timing Analysis
Sample period accuracy	$\pm(250 \text{ ps} + 0.01\% \text{ of sample period})$	$\pm(250 \text{ ps} + 0.01\% \text{ of sample period})$
Channel-to-channel skew	< 1.5 ns	< 1.5 ns
Time interval accuracy	$\pm[\text{sample period} + (\text{channel-to-channel skew}) + (0.01\% \text{ of time interval})]$	$\pm[\text{sample period} + (\text{channel-to-channel skew}) + (0.01\% \text{ of time interval})]$
Minimum data pulse width	1.5 ns for data capture 5.1 ns for trigger sequencing	3.8 ns for data capture 5.1 ns for trigger sequencing
Maximum trigger sequencer speed	200 MHz	200 MHz
Trigger resources	16 Patterns evaluated as =, ≠, >, <, ≥, ≤ 15 Ranges evaluated as in range, not in range 2 Edge/glitch (2 Timers per module) -1 2 Global counters 1 Occurrence counter per sequence level 4 Flags, Arm In	16 Patterns evaluated as =, ≠, >, <, ≥, ≤ 15 Ranges evaluated as in range, not in range 2 Edge/glitch (2 Timers per module) -1 2 Global counters 1 Occurrence counter per sequence level 4 Flags, Arm In
Trigger resource conditions	Arbitrary Boolean combinations	Arbitrary Boolean combinations
Trigger actions	Goto Trigger and fill memory Trigger and goto Timer start/stop/pause/resume Global counter increment/reset Occurrence counter reset	Goto Trigger and fill memory Trigger and goto Timer/start/stop/pause/resume Global counter increment/reset Occurrence counter reset
Maximum global counter	16,777,215	16,777,215
Maximum occurrence counter	16,777,215	16,777,215
Timer value range	100 ns to 5497 seconds	100 ns to 5497 seconds
Timer resolution	5 ns	5 ns
Timer accuracy	$\pm(10 \text{ ns} + 0.01\%)$	$\pm(10 \text{ ns} + 0.01\%)$
Greater than duration	5 ns to 83 ms in 5 ns increments	5 ns to 83 ms in 5 ns increments
Less than duration	10 ns to 83 ms in 5 ns increments	10 ns to 83 ms in 5 ns increments
Timer reset latency	60 ns	60 ns
Data in to BNC port out delay latency	150 ns	150 ns
Flag set/reset to evaluation latency	110 ns	110 ns
Environmental		
Operating temperature	0 deg C to 45 deg C	

State/Timing Modules Specifications and Characteristics

Agilent Technologies 16760A Supplemental Specifications and Characteristics (continued)

Eye scan mode	1.5 Gb/s mode	800 Mb/s mode
Maximum clock rate	1.5 Gb/s	800 Mb/s
Sample position range relative to clock	+5ns to 10 ns	-4 ns to +4 ns
Sample (time) position resolution	12 ps	12 ps
Sample position (time) accuracy	+/- (50 ps + 0.01 * sample position)	+/- (50 ps + 0.01 * sample position)
Number of channels	16*(number of modules)	34*(number of modules)-1
Input dynamic range	-3.0 Vdc to +5.0 Vdc	-3.0 Vdc to +5.0 Vdc
Threshold range	-3.0 Vdc to +5.0 Vdc	-3.0 Vdc to +5.0 Vdc
Threshold resolution	2 mV	2 mV
Threshold accuracy	+/- (30 mV + 1% of setting)	+/- (30 mV + 1% of setting)
Equivalent rise time [1]	150 ps	150 ps
Equivalent bandwidth [1]	2.33 GHz	2.33 GHz
Minimum detectable pulse width at minimum signal amplitude [1]	500 ps	750 ps
Jitter	10 ps RMS	10 ps RMS
Noise floor	25 mV p-p	25 mV p-p
Channel-to-channel skew, maximum between any two channels	100 ps	100 ps

[1] E5378A, E5379A, and E5382A probes only.

Qualified eye scan mode

In the qualified eye scan mode, a single qualifier input defines what clock cycles are to be acquired and what cycles are to be ignored in eye scan acquisition.

Qualified eye scan is supported in the 16760A in 800 Mb/s eye scan mode only. Qualified eye scan is only available for double-edged clock (double-data-rate).

Channels available

The following channels are not available for qualified eye scan measurements.

Master module, Pod 1
Master module, Pod 2, Bit 0, Bit 14, Bit 1, Bit 15, Bit 2, K-clock (the qualifier input itself).
All channels on all boards other than the master board are available for qualified eye scans.

Timing

The analyzer samples the qualification signal at the beginning of each clock cycle (i.e. at the first of each pair of data transfers). The analyzer can be configured to treat either the rising edge or the falling edge of the clock as the first edge of each clock cycle. The qualifier should remain stable for the entire duration of each burst.

The qualifier must be pipelined (delayed) by one clock cycle before transmittal to the analyzer.

Oscilloscope Modules Specifications and Characteristics

16534A Specifications*

Bandwidth	dc to 500 MHz
dc offset accuracy	±(1% of offset + 2% of full scale)
dc voltage measurement accuracy	±(1.5% of full scale + offset accuracy)
Time interval measurement accuracy at maximum sampling rate, on a single scope card, on a single acquisition	±[(0.005% of D T) + (2E-6 x delay setting) + 100 ps]
Trigger sensitivity (See notes)	<ul style="list-style-type: none"> • dc to 50 MHz • 50 MHz to 500 MHz
	<ul style="list-style-type: none"> • 0.06 full scale • 0.13 full scale
Input resistance	1 MΩ ±1% 50 Ω ±1%

* Specifications refer to the input to the BNC connector

Notes:

- Specifications apply only within ± 10° C of the temperature at which the most recent calibration was performed.
- Specifications apply only after operational accuracy calibration is performed in the frame in which the oscilloscope module is installed.
- Display magnification is used below 56 mV full scale. For sensitivities from 16 mV to 56 mV full scale, full scale is defined as 56 mV.

Characteristics

General

Maximum sampling rate	2 GSa/s
Number of channels	<ul style="list-style-type: none"> • 2 to 8 using the same time base and trigger. • Up to 10 channels may be installed in a single 16700 frame, or up to 20 in a single system using a 16701 expansion frame.
Waveform record length	32768 points

Oscilloscope Modules Specifications and Characteristics

16534A Characteristics*

Vertical (Voltage)

Vertical sensitivity range	16 mV full scale to 40 V full scale
Vertical resolution	8 bits full scale
Rise time (calculated from bandwidth)	700 ps
dc gain accuracy	$\pm(1.25\%$ of full scale + 0.08% per °C difference from calibration temperature)
dc offset range	
Vertical sensitivity	Offset range
• 16 mV full scale to 400 mV full scale	• ± 2 V
• 400 mV full scale to 2.0 V full scale	• ± 10 V
• 2.0 V full scale to 10 V full scale	• ± 50 V
• 10 V full scale to 40 V full scale	• ± 250 V
Probe attenuation	Any ratio from 1:1E-9 to 1:1E+6
Channel-to-channel isolation (with channel sensitivities equal)	
• dc–50 MHz	• 40 dB
• 50 MHz–500 MHz	• 30 dB
Maximum safe input voltage	
• 1 M Ω	• ± 250 V dc + peak ac (<10 kHz)
• 50 Ω	• 5 Vrms

* Characteristics refer to the input at the BNC connector

Oscilloscope Modules Specifications and Characteristics

16534A Characteristics

Horizontal (Time)

Time base ranges	0.5 ns/div to 5 s/div
Time base resolution	10 ps
Delay range	
• pretrigger	• -32 K x sample period
• posttrigger	• 320 ms or 1.6E7 x sample period, whichever is greater
Time interval measurement accuracy for sampling rates other than maximum, for bandwidth-limited signals [signal rise time > 1.4/(sampling rate)], on a single card, on a single acquisition	$\pm\{(0.005\% \text{ of } \Delta T) + (2E-6 \times \text{delay setting}) + [0.15/(\text{sample rate})]\}$
Time interval measurement accuracy for 2, 3, or 4 Agilent 16533As or 16534As operating on a single time base, for measurements made between channels on different cards, at maximum sampling rate	$\pm [(0.005\% \text{ of } \Delta T) + (2E-6 \times \text{delay setting}) + 300 \text{ ps}]$

Trigger

Trigger level range (See notes)	$\pm 1.5 \times$ full scale from center of screen
Trigger modes	
• Immediate	• Triggers immediately after arming condition is met
• Edge	• Triggers on rising or falling edge on channel 1 or channel 2
• Pattern	• Triggers on entering or exiting a specified pattern across both channels
• Auto condition	• Self-triggers if trigger is not satisfied within approximately 50 ms after arming
• Events delay	• The trigger can be set to occur on the nth occurrence of an edge or pattern, $n \leq 32000$
• Intermodule	• Arms another measurement module or activates the port out BNC connector when the trigger condition is met

Notes:

- Specifications apply only within $\pm 10^\circ \text{C}$ of the temperature at which the most recent calibration was performed.
- Specifications apply only after operational accuracy calibration is performed in the frame in which the oscilloscope module is installed.
- Display magnification is used below 56 mV full scale. For sensitivities from 16 mV to 56 mV full scale, full scale is defined as 56 mV.

Pattern Generation Modules Specifications and Characteristics

16720A Pattern Generator Characteristics

Maximum memory depth	16 MVectors
Number of output channels at ≤ 300 MHz clock	24
Number of output channels at ≤ 180 MHz clock	48
Number of output channels at ≤ 200 MHz clock	24
Number of output channels at ≤ 100 MHz clock	48
Number of different macros	100
Maximum number of lines in a macro	1024
Maximum number of parameters in a macro	10
Maximum number of macro invocations	1000
Maximum loop count in a repeat loop	20000
Maximum number of repeat loop invocations	1000
Maximum number of "Wait" event patterns	4
Number of input lines to define a pattern	3
Maximum number of modules in a system	5
Maximum width of a vector (in a 5 module system)	240 bits
Maximum width of a label	32 bits
Maximum number of labels	126
Maximum number of vectors in binary format	16 MVectors
Minimum number of vectors in binary format	4096

Lead Set Characteristics

Agilent 10474A 8-channel probe lead set	Provides most cost effective lead set for the 16522A and 16720A clock and data pods. Grabbers are not included. Lead wire length is 12 inches.
Agilent 10347A 8-channel probe lead set	Provides 50 Ω coaxial lead set for unterminated signals, required for 10465A ECL Data Pod (unterminated). Grabbers are not included.
Agilent 10498A 8-channel probe lead set	Provides most cost effective lead set for the 16522A and 16720A clock and data pods. Grabbers are not included. Lead wire length is 6 inches.

Pattern Generation Modules Specifications and Characteristics

Data Pod Characteristics

Note: Data Pod output parametrics depend on the output driver and the impedance load of the target system. Check the device data book for the specific drivers listed for each pod.

Agilent 10461A TTL Data Pod

Output type	10H125 with 100 Ω series
Maximum clock	200 MHz
Skew [1]	typical < 2 ns; worst case = 4 ns
Recommended lead set	Agilent 10474A

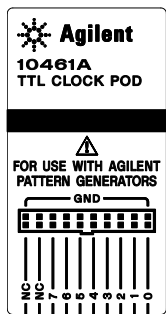

Agilent 10462A 3-State TTL/CMOS Data Pod

Output type	74ACT11244 with 100 Ω series; 10H125 on non 3-state channel 7 [2]
3-state enable	negative true, 100 K Ω to GND, enabled on no connect
Maximum clock	100 MHz
Skew [1]	typical < 4 ns; worst case = 12 ns
Recommended lead set	Agilent 10474A

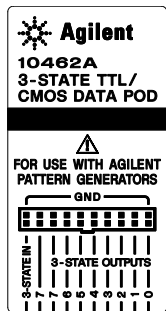

Agilent 10464A ECL Data Pod (terminated)

Output type	10H115 with 330 Ω pulldown, 47 Ω series
Maximum clock	300 MHz
Skew [1]	typical < 1 ns; worst case = 2 ns
Recommended lead set	Agilent 10474A

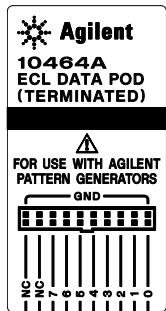
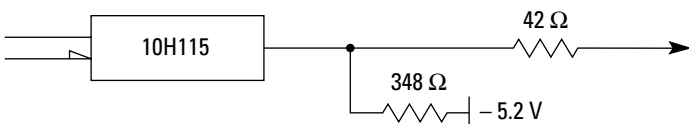

Pattern Generation Modules Specifications and Characteristics

Agilent 10465A ECL Data Pod (unterminated)

Output type	10H115 (no termination)
Maximum clock	300 MHz
Skew [1]	typical < 1 ns; worst case = 2 ns
Recommended lead set	Agilent 10347A

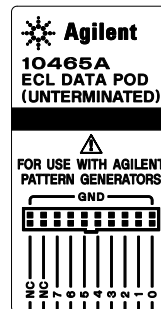

Agilent 10466A 3-State TTL/3.3 volt Data Pod

Output type	74LVT244 with 100 Ω series; 10H125 on non 3-state channel 7 [2]
3-state enable	negative true, 100 K Ω to GND, enabled on no connect
Maximum clock	200 MHz
Skew [1]	typical < 3 ns; worst case = 7 ns
Recommended lead set	Agilent 10474A

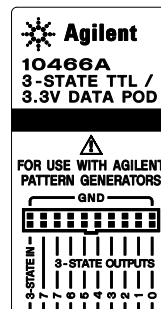
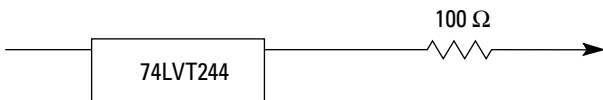

[1] Typical skew measurements made at pod connector with approximately 10 pF/50 K Ω load to GND; worst case skew numbers are a calculation of worst case conditions through circuits. Both numbers apply to any channel within a single or multiple module system.

[2] Channel 7 on the 3-state pods has been brought out in parallel as a non 3-state signal. By looping this output back into the 3-state enable line, the channel can be used as a 3-state enable.

Pattern Generation Modules Specifications and Characteristics

Agilent 10469A 5 volt PECL Data Pod

Output type	100EL90 (5V) with 348 ohm pulldown to ground and 42 ohm in series
Maximum clock	300 MHz
Skew [1]	typical < 500 ps; worst case = 1 ns
Recommended lead set	Agilent 10498A

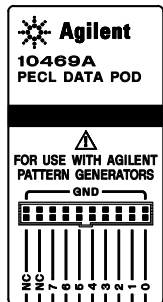
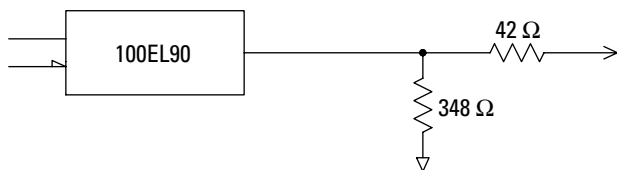

Agilent 10471A 3.3 volt LVPECL Data Pod

Output type	100LVEL90 (3.3V) with 215 ohm pulldown to ground and 42 ohm in series
Maximum clock	300 MHz
Skew [1]	typical < 500 ps; worst case = 1 ns
Recommended lead set	Agilent 10498A

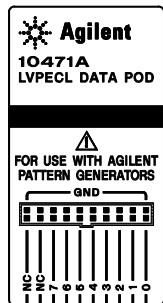
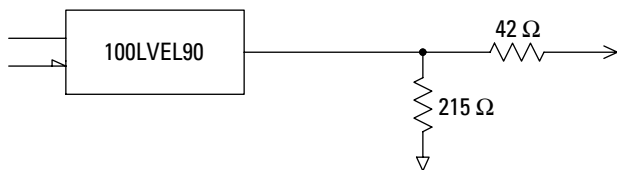

Agilent 10473A 3-State 2.5 Volt Data Pod

Output type	74AVC16244
3-state enable	negative true, 38 KΩ to GND, enabled on no connect
Maximum clock	300 MHz
Skew [1]	typical < 1.5 ns; worst case = 2 ns
Recommended lead set	Agilent 10498A

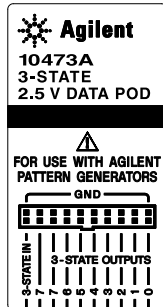
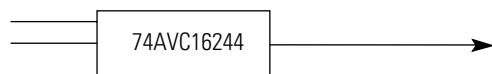

[1] Typical skew measurements made at pod connector with approximately 10 pF/50 KΩ load to GND; worst case skew numbers are a calculation of worst case conditions through circuits. Both numbers apply to any channel within a single or multiple module system.

[2] Channel 7 on the 3-state pods has been brought out in parallel as a non 3-state signal. By looping this output back into the 3-state enable line, the channel can be used as a 3-state enable.

Pattern Generation Modules Specifications and Characteristics

Agilent 10476A 3-State 1.8 Volt Data Pod

Output type	74AVC16244
3-state enable	negative true, 38 K Ω to GND, enabled on no connect
Maximum clock	300 MHz
Skew [1]	typical < 1.5 ns; worst case = 2 ns
Recommended lead set	Agilent 10498A

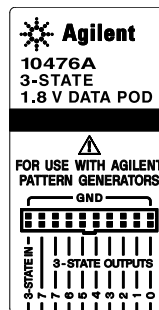
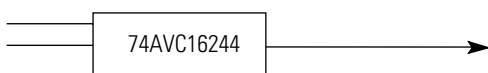

Agilent 10483A 3-State 3.3 Volt Data Pod

Output type	74AVC16244
3-state enable	negative true, 38 K Ω to GND, enabled on no connect
Maximum clock	300 MHz
Skew [1]	typical < 1.5 ns; worst case = 2 ns
Recommended lead set	Agilent 10498A

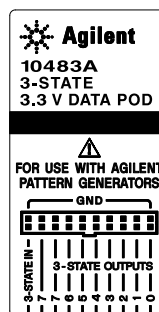
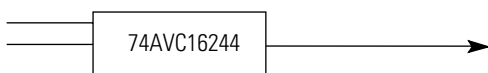

Agilent E8141A LVDS Data Pod

Output type	65LVDS389 (LVDS data lines) 10H125 (TTL non-3-state channel 7)
3-state enable	positive true TTL; no connect=enabled
Maximum clock	300 MHz
Skew	typical < 1 ns; worst case = 2 ns
Recommended lead set:	E8142A
Recommended lead set	Agilent 10498A

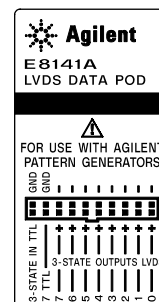
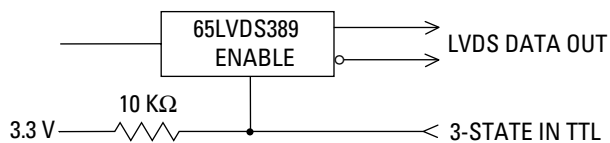

[1] Typical skew measurements made at pod connector with approximately 10 pF/50 K Ω load to GND; worst case skew numbers are a calculation of worst case conditions through circuits. Both numbers apply to any channel within a single or multiple module system.

Pattern Generation Modules Specifications and Characteristics

Data Cable Characteristics Without a Data Pod

The Agilent 16720A and 16522A data cables without a data pod provide an ECL terminated (1 K Ω to -5.2V) differential signal (from a type 10E156 or 10E154 driver). These are usable when received by a differential receiver, preferably with a 100 Ω termination across the lines. These signals should not be used single ended due to the slow fall time and shifted voltage threshold (they are not ECL compatible).

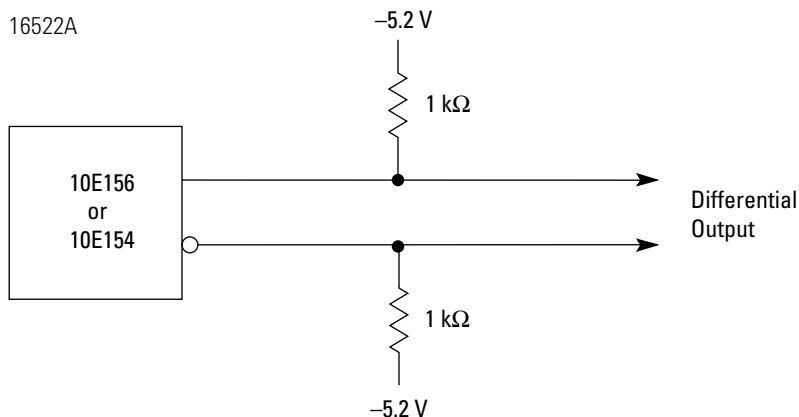
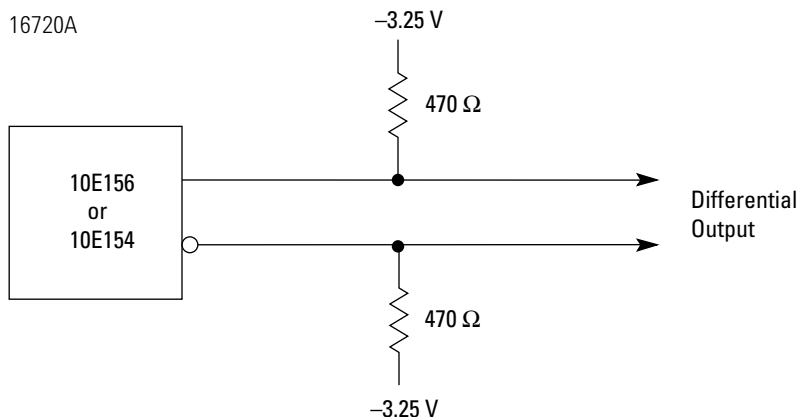

16720A and 16522 CABLE PIN OUTS

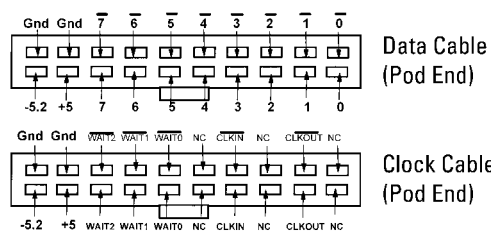

Pattern Generation Modules Specifications and Characteristics

Clock Cable Characteristics Without a Clock Pod

The Agilent 16720A and 16522A clock cables without a clock pod provide an ECL terminated (1 K Ω to -5.2V) differential signal (from a type 10E164 driver). These are usable when received by a differential receiver, preferably with a 100 Ω termination across the lines. These signals should not be used single ended due to the slow fall time and shifted voltage threshold (they are not ECL compatible).

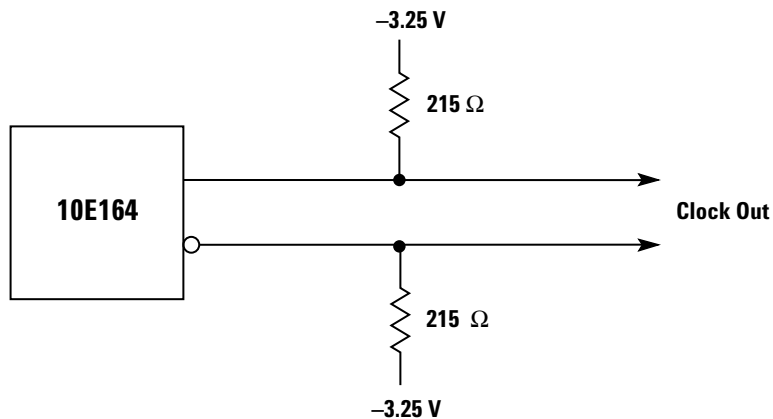
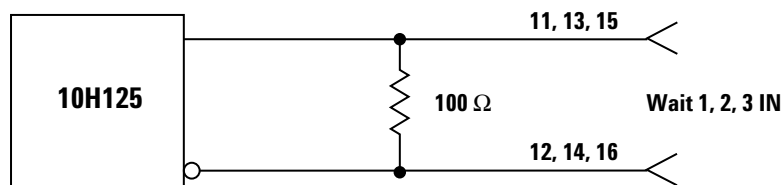
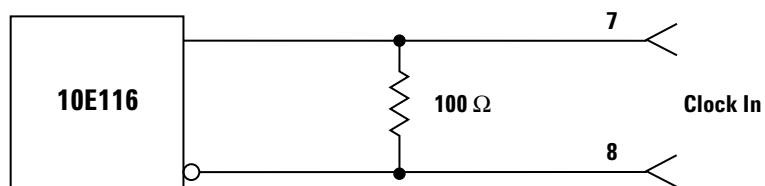

Pattern Generation Modules Specifications and Characteristics

Clock Pod Characteristics

10460A TTL Clock Pod

Clock output type	10H125 with 47 Ω series; true & inverted
Clock output rate	100 MHz maximum
Clock out delay only)	approximately 8 ns total in 14 steps (16720A only); 11 ns maximum in 9 steps (16522A)
Clock input type	TTL – 10H124
Clock input rate	dc to 100 MHz
Pattern input type	TTL – 10H124 (no connect is logic 1)
Clock-in to clock-out	approximately 30 ns
Pattern-in to recognition	approximately 15 ns + 1 clk period
Recommended lead set	Agilent 10474A

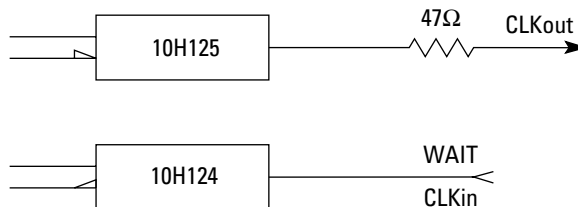
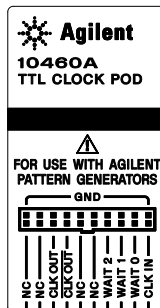

10463A ECL Clock Pod

Clock output type	10H116 differential unterminated; and differential with 330 Ω to –5.2V and 47 Ω series
Clock output rate	300 MHz maximum
Clock out delay only)	approximately 8 ns total in 14 steps (16720A only); 11 ns maximum in 9 steps (16522A)
Clock input type	ECL – 10H116 with 50 KΩ to –5.2v
Clock input rate	dc to 300 MHz
Pattern input type	ECL – 10H116 with 50 KΩ (no connect is logic 0)
Clock-in to clock-out	approximately 30 ns
Pattern-in to recognition	approximately 15 ns + 1 clk period
Recommended lead set	Agilent 10474A

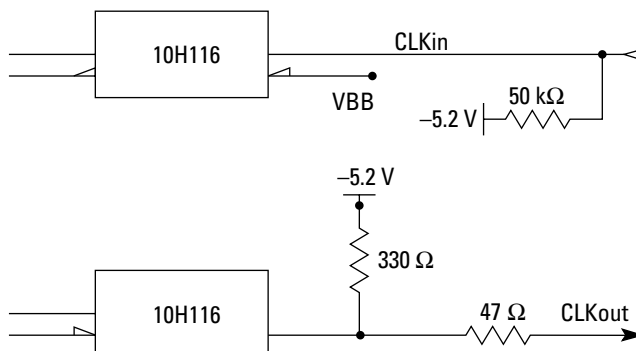
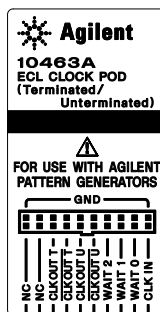

Pattern Generation Modules Specifications and Characteristics

10468A 5 volt PECL Clock Pod

Clock output type	100EL90 (5V) with 348 ohm pulldown to ground and 42 ohm in series
Clock output rate	300 MHz maximum
Clock out delay	approximately 8 ns total in 14 steps (16720A only); 11 ns maximum in 9 steps (16522A only)
Clock input type	100EL91 PECL (5V), no termination
Clock input rate	dc to 300 MHz
Pattern input type	100EL91 PECL (5V), no termination (no connect is logic 0)
Clock-in to clock-out	approximately 30 ns
Pattern-in to recognition	approximately 15 ns + 1 clk period
Recommended lead set	Agilent 10498A

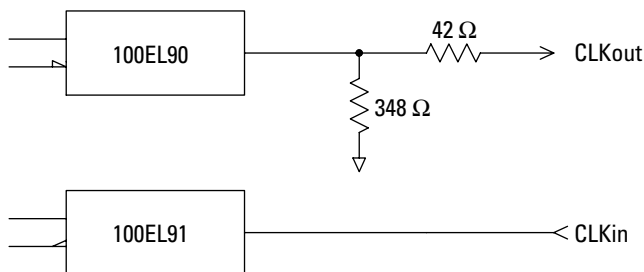
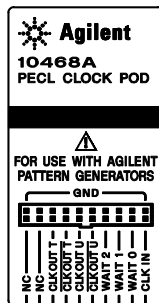

10470A 3.3 volt LVPECL Clock Pod

Clock output type	100LVEL90 (3.3V) with 215 ohm pulldown to ground and 42 ohm in series
Clock output rate	300 MHz maximum
Clock out delay	approximately 8 ns total in 14 steps (16720A only); 11 ns maximum in 9 steps (16522A only)
Clock input type	100LVEL91 LVPECL (3.3V), no termination
Clock input rate	dc to 300 MHz
Pattern input type	100LVEL91 LVPECL (3.3V), no termination (no connect is logic 0)
Clock-in to clock-out	approximately 30 ns
Pattern-in to recognition	approximately 15 ns + 1 clk period
Recommended lead set	Agilent 10498A

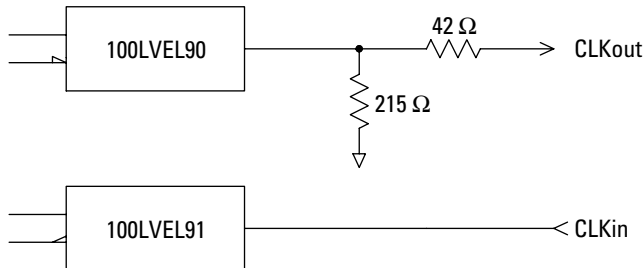
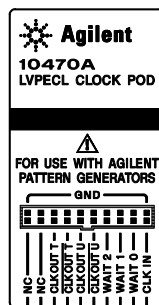

Pattern Generation Modules Specifications and Characteristics

10472A 2.5 volt Clock Pod

Clock output type	74AVC16244
Clock output rate	200 MHz maximum
Clock out delay only)	approximately 8 ns total in 14 steps (16720A only); 11 ns maximum in 9 steps (16522A)
Clock input type	74AVC16244 (3.6V max)
Clock input rate	dc to 200 MHz
Pattern input type	74AVC16244 (3.6V max; no connect is logic 0)
Clock-in to clock-out	approximately 30 ns
Pattern-in to recognition	approximately 15 ns + 1 clk period
Recommended lead set	Agilent 10498A

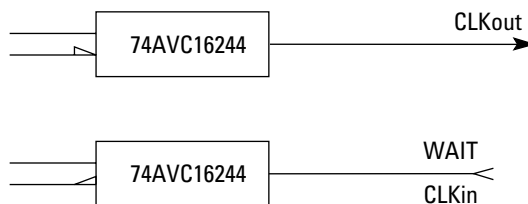
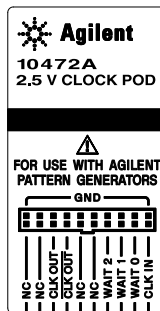

10475A 1.8 volt Clock Pod

Clock output type	74AVC16244
Clock output rate	200 MHz maximum
Clock out delay only)	approximately 8 ns total in 14 steps (16720A only); 11 ns maximum in 9 steps (16522A)
Clock input type	74AVC16244 (3.6V max)
Clock input rate	dc to 200 MHz
Pattern input type	74AVC16244 (3.6V max; no connect is logic 0)
Clock-in to clock-out	approximately 30 ns
Pattern-in to recognition	approximately 15 ns + 1 clk period
Recommended lead set	Agilent 10498A

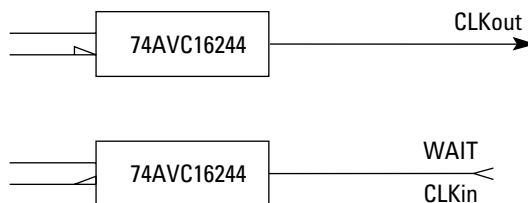
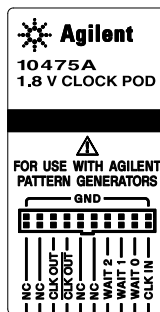

Pattern Generation Modules Specifications and Characteristics

10477A 3.3 volt Clock Pod

Clock output type	74AVC16244
Clock output rate	200 MHz maximum
Clock out delay	approximately 8 ns total in 14 steps (16720A only); 11 ns maximum in 9 steps (16522A only)
Clock input type	74AVC16244 (3.6V max)
Clock input rate	dc to 200 MHz
Pattern input type	74AVC16244 (3.6V max; no connect is logic 0)
Clock-in to clock-out	approximately 30 ns
Pattern-in to recognition	approximately 15 ns + 1 clk period
Recommended lead set	Agilent 10498A

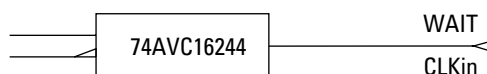
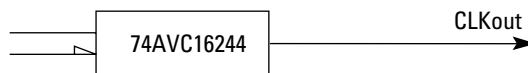
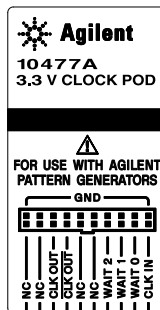

E8140A LVDS Clock Pod

Clock output type	65LVDS179 (LVDS) and 10H125 (TTL)
Clock output rate	200 MHz maximum (LVDS and TTL)
Clock out delay	approximately 8 ns total in 14 steps
Clock input type	65LVDS179 (LVDS with 100 ohm)
Clock input rate	dc to 150 MHz (LVDS)
Pattern input type	10H124 (TTL) (no connect = logic 1)
Clock-in to clock-out	approximately 30 ns
Pattern-in to recognition	approximately 15 ns + 1 clk period
Recommended lead set	Agilent 10498A

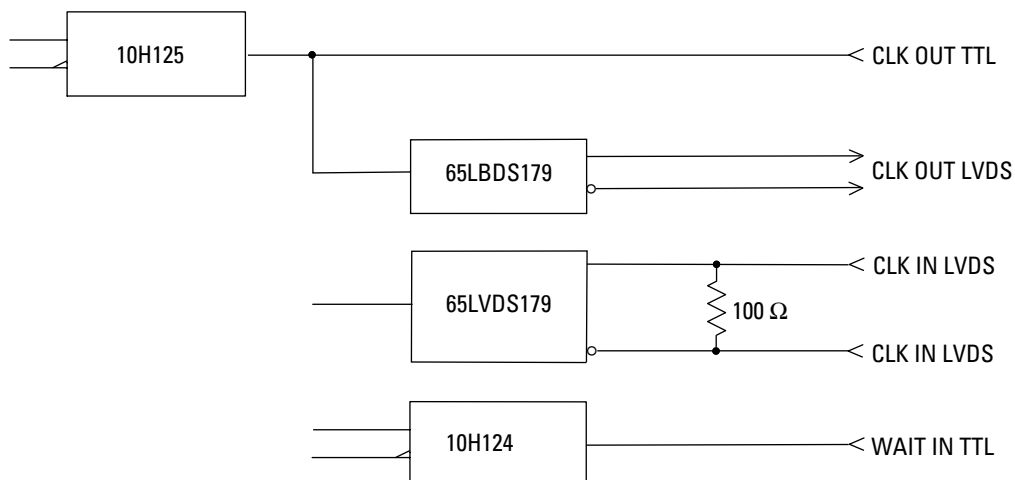
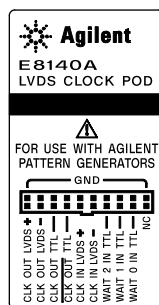

Trade-In, Trade-Up

Advance to the Latest Technology with Agilent's "Trade-Up" Program

Comprehensive	Economical	Convenient
<ul style="list-style-type: none"> • Purchase from an extensive list of Agilent test and measurement products • Trade in a wide variety of test equipment for substantial credit 	<ul style="list-style-type: none"> • Upgrade for less • Stretch your test equipment budget • Reduce support costs for aging equipment 	<ul style="list-style-type: none"> • Simply call your local Agilent sales office • Mention Agilent Promotion 4.65 • Let us evaluate your savings opportunities

How to Upgrade for Less:

Purchase...	Trade in...	Receive...
Eligible New Agilent Product	Similar ^[1] Agilent Product	Agilent's "buy-back" price ^[2]

[1] A "similar" product is considered to be part of the same product family (for example, oscilloscope for oscilloscope) with comparable functionality and application.

[2] Agilent's "buy-back" price varies based on the model, option configuration, and age of the trade-in product.

Terms and Conditions

- This offer is void where prohibited.
- This offer applies to end-user customers only. Rental companies and equipment brokers are excluded.
- This offer is applicable to the return of fewer than 10 products or \$100,000 (U.S. dollars) in trade-in credit.
- The total trade-in credit may not exceed 100% of the cost of the eligible new product(s). Any credit in excess of that amount may not be applied toward a later purchase.
- Trade-in credit amounts and product eligibility are subject to change at any time without advance notice.
- Refurbished Agilent equipment is not eligible for purchase under this program.
- All trade-in products must be in working condition and have no interior, exterior, or performance modifications.
- To ensure timely release of credit, all trade-in products must be returned to Agilent within 30 days after receipt of the newly purchased Agilent product.
- Customer is responsible for all costs associated with shipping the trade-in product(s) to Agilent.
- Additional requirements may apply. Please contact your local Agilent sales office for information.

Ordering Information

Mainframes and Mainframe Accessories

Product Number	Description	Includes
16700B	Modular mainframe with five measurement module slots and one emulation or multiframe module slot	<ul style="list-style-type: none"> • One DIN keyboard • One three-button DIN mouse • One ten-conductor, flying lead cable for target control port • Training kit • One internal CD ROM drive • One internal 3.5" floppy drive
16702B	Modular frame with built-in 800x600 LCD display with touchscreen. Includes five measurement slots and one emulation or multiframe module slot	Same as 16700B plus: <ul style="list-style-type: none"> • 12.1" touchscreen display • Display knobs • Dedicated hot keys
16701B	Expansion frame with five measurement module slots and two emulation module slots. Requires a 16700A/B or 16702A/B	1 ft. and 3 ft. interface cables
1184A Testmobile	4 wheeled equipment cart specifically designed to carry the 16700 Series logic analyzer, expansion frame, and monitor	Drawer, keyboard tray, mouse tray, strap for stabilizing monitor

Mainframe Options

Option Number	Description	16700B or 16702B	16700A or 16702A	16701B	16701A
001	Add 17-inch 1280x1024 monitor	√	√		
003	Performance option. Up to 256 MBytes total system RAM, 4 MBytes total video RAM.	√ (256 MB)	√ (160 MB)		
004*	Add external CD-ROM drive and cable		√		
008	External, auxiliary 18 GByte hard disk drive	√	√		
009	Removable internal hard disk	√	√		
012	Multiframe option	√			
0B3	Add service guide		√		
1CM	Add rack-mount kit (all but 16702B)	√	√	√	√
AXC	Equipment shelf (16702B only)	√			
ABJ	Japanese localization		√		
W17	Convert standard warranty to one year on-site warranty	√	√	√	√
W30	Extend standard warranty to three year return-to-Agilent warranty	√	√	√	√
W50	Extend standard warranty to five year return-to-Agilent warranty	√	√	√	√

* Built-in CD-ROM drive standard on 16700B Series

Ordering Information

E5850A Logic Analyzer - Infiniium Oscilloscope Correlation Time Fixture

Product Number	Description	Includes
E5850A	Logic analyzer - Infiniium oscilloscope time correlation fixture	All BNC cables needed to connect to logic analyzer and oscilloscope



Figure 7.1. Agilent 1184A testmobile cart.

Agilent 1184A Testmobile

The Agilent 1184A testmobile gives you a convenient means of organizing and transporting your logic analysis system mainframes and accessories.

The testmobile includes the following:

- Drawer for accessories (probes, cables, power cords)

- Keyboard tray with adjustable tilt and height
- Mouse extension on keyboard tray for either right or left hand operation
- Locking casters for stability on uneven surfaces
- Strap to stabilize the monitor
- Load limits: Top tray: 68.2 kg (150.0 lb.) Lower tray: 68.2 kg (150.0 lb.) Total: 136.4 kg (300.0 lb.)

Weight

	Max Net	Max Shipping
1184A	48.0 kg (106.0 lb)	59.0 kg (130.0 lbs)

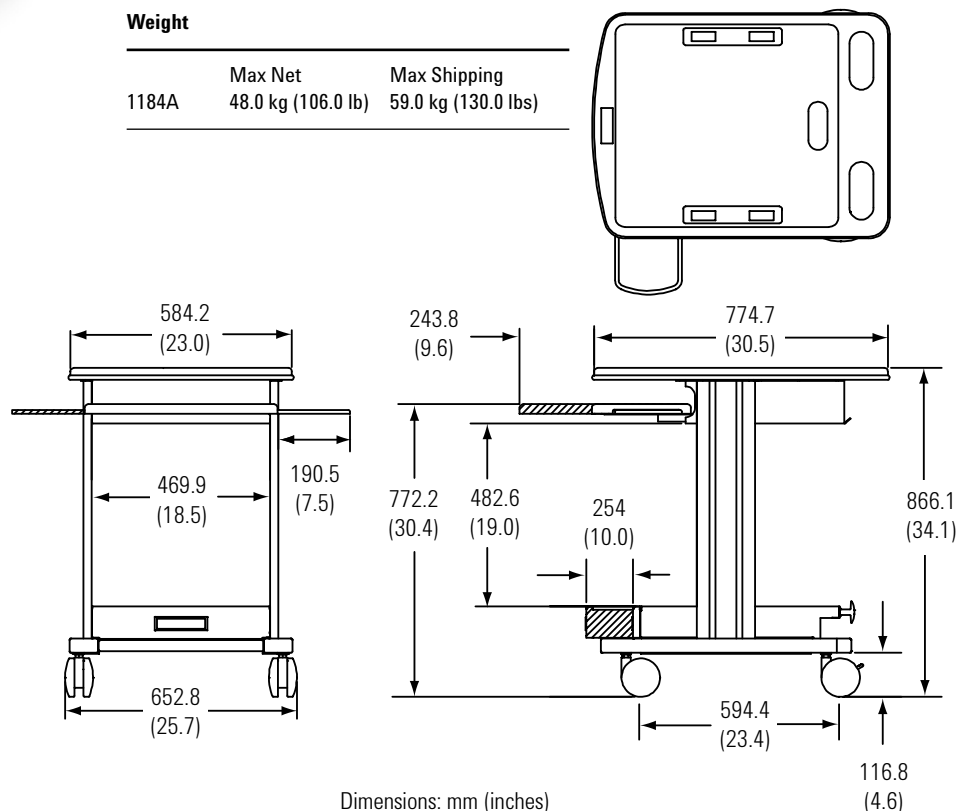

Figure 7.2. Agilent 1184A testmobile cart dimensions.

Ordering Information

Measurement Module Compatibility Table

Measurement Module Category	Model Number	Description	16700 Series	16600A Series	16500C*	16500A/B*
State and Timing	16510A*	25 MHz State; 100 MHz Timing; 1 K memory depth			√	√
	16510B*	35 MHz State; 100 MHz Timing; 1 K memory depth			√	√
	16540A/16541A*	100 MHz State; 100 MHz Timing; 4 K memory depth			√	√
	16540D/16541D*	100 MHz State; 100 MHz Timing; 16 K memory depth			√	√
	16542A*	100 MHz State; 100 MHz Timing; 1 M memory depth			√	√
	16550A*	100 MHz State; 500 MHz Timing; 4/8 K memory depth	√	√	√	√
	16554A*	100 MHz State; 250 MHz Timing; 512 K/1 M memory depth	√	√	√	
	16555A/16555D*	110 MHz State; 500 MHz Timing; 2/4 M memory depth	√	√	√	
	16556A/16556D*	100 MHz State; 400 MHz Timing; 2/4 M memory depth	√	√	√	
	16557D	140 MHz State; 500 MHz Timing; 2/4 M memory depth	√	√	√	
	16710A	100 MHz State; 500 MHz Timing; 8 K memory depth	√	√		
	16711A	100 MHz State; 500 MHz Timing; 32 K memory depth	√	√		
	16712A	100 MHz State; 500 MHz Timing; 128 K memory depth	√	√		
	16715A	167 MHz State; 667 MHz Timing; 2/4 M memory depth	√			
	16716A	167 MHz State; 667 MHz Timing; 2 GHz Timing Zoom; 512 K/1 M memory depth	√			
	16717A	333 MHz State; 667 MHz Timing; 2 GHz Timing Zoom; 2/4 M memory depth	√			
	16718A*	333 MHz State; 667 MHz Timing; 2 GHz Timing Zoom; 8/16 M memory depth	√			
	16719A*	333 MHz State; 667 MHz Timing; 2 GHz Timing Zoom; 32/64 M memory depth	√			
	16740A	200 MHz State; 800 MHz Timing; 2 GHz Timing Zoom 2/1 M memory depth	√			
	16741A	200 MHz State; 800 MHz Timing; 2 GHz Timing Zoom 8/4 M memory depth	√			
	16742A	200 MHz State; 800 MHz Timing; 2 GHz Timing Zoom 32/16 M memory depth	√			
	16750A	400 MHz State; 800 MHz Timing; 2 GHz Timing Zoom; 4/8 M memory depth	√			
	16751A	400 MHz State; 800 MHz Timing; 2 GHz Timing Zoom; 16/32 M memory depth	√			
	16752A	400 MHz State; 800 MHz Timing; 2 GHz Timing Zoom; 32/64 M memory depth	√			
	16760A	1.25 Gb/s State; 800 MHz Timing; 34 channel; 64 M memory depth	√			

* Discontinued products.

Ordering Information

Measurement Module Compatibility Table (continued)

Measurement Module Category	Model Number	Description	16700 Series	16600 Series	16500C*	16500A/B*
Oscilloscope	16530A/16531A*	2 Channel; 100 MHz Bandwidth; 400 MSa/s; 4 K memory depth			√	√
	16532A*	2 Channel; 250 MHz Bandwidth; 1 GSa/s; 8 K memory depth			√	√
	16533A*	2 Channel; 250 MHz Bandwidth; 1 GSa/s; 32 K memory depth	√	√	√	
	16534A	2 Channel; 500 MHz Bandwidth; 2 GSa/s; 32 K memory depth	√	√	√	
High Speed Timing	16515A/16516A*	1 GHz Timing; 8 K memory depth			√	√
	16517A/16518A	4 GHz Timing; 1GHz Synchronous State; 64 K memory depth	√	√	√	√
Pattern Generator	16520A/16521A*	50 MV/s; 4 K memory; 12 Channel			√	√
	16522A*	200 MV/s; 258 K memory; 100 MHz in 40 Channel; 200 MHz in 20 Channel	√	√	√	
	16720A	300 MV/s; 180 MHz in 48 Channel, 16 MV memory; 300 MHz in 24 Channel, 8 MV memory	√			
Emulation	E5901A	Emulation Module Products	√	√		
	E5901B	Emulation Module Products	√			

* Discontinued products.

Options for Agilent 16700 Series State/Timing Modules

Agilent Module Product Numbers	Option	Option Description
16517A/16518A	0B3	Add service manual
16710A	1BP	MIL-STD-45662A calibration with test data
16711A	W17	Convert standard warranty to one-year on-site warranty
16712A		
16715A		
16716A		
16717A		
16750A		
16751A		
16752A		
16760A	010	add one E5378A, single-ended, 34-channel probe
	011	add one E5379A, differential, 17-channel probe
	012	add one E5380A, Mictor-compatible probe
	013	add one E5382A, single-ended flying lead probe set
	0B3	Add service manual (available April 2001)
	A6J	MIL-STD-45662A calibration with test data (available April 2001)
	W17	Convert standard warranty to one-year on-site warranty

Ordering Information

Agilent Wedge Probe Adapters

IC Leg Spacing	Number of Signals	Quantity of Probes Shipped	Probe Model Number
0.5 mm	3	1	E2613A
0.5 mm	3	2	E2613B
0.5 mm	8	1	E2614A
0.5 mm	16	1	E2643A
0.65 mm	3	1	E2615A
0.65 mm	3	2	E2615B
0.65 mm	8	1	E2616A
0.65 mm	16	1	E26144A

Agilent Elastomeric Probing Solutions

Package Type	IC Leg Spacing	Probe Model Number
240-pin PQFP/CQFP	0.5 mm	E5363A Probe. E5371A 1/4 flexible cable
208-pin PQFP/CQFP	0.5 mm	E5374A Probe. E5371A 1/4 flexible cable
176-pin PQFP	0.5 mm	E5348A Probe. E5349A 1/4 flexible cable
160-pin QFP	0.5 mm	E5377A Probe. E5349A 1/4 flexible cable
160-pin PQFP/CQFP	0.65 mm	E5373A Probe. E5349A 1/4 flexible cable
144-pin PQFP/CQFP	0.65 mm	E5361A Probe. E5340A 1/4 flexible cable
144-pin TQFP	0.65 mm	E5336A Probe. E5340A 1/4 flexible cable

Ordering Information

Options and Accessories for Agilent 16534A Oscilloscope Modules

Agilent Option	Option Description
<ul style="list-style-type: none"> • 001 • ABJ • 0B0 • 1BP • 0B3 • 0BF • W17 • W03 	<ul style="list-style-type: none"> • Add one Agilent 1145A, dual, active 750 MHz probe • Japanese user's reference • Delete manuals • MIL-STD 45662A calibration with test data • Add service manual • Add programming manual set for a 16500 (not required for a 16700) • Convert standard warranty to one-year-on-site warranty • Convert standard warranty to 90-day-on-site warranty

Agilent Model Number	Accessory Description
1144A	800 MHz active probe (power for two Agilent 1144A active probes is provided by the Agilent 16533A and 16534A) (requires 01144-61604 power splitter to operate two 1144As)
01144-61604	Power splitter. Allows operation of two Agilent 1144A active probes from one Agilent 16533A or 16534A
1145A	750-MHz dual, active probe (power for Agilent 1145A active probes is provided by the Agilent 16533A and 16534A)
1141A	200 MHz differential probe (requires an Agilent 1142A power supply)
1142A	Probe power supply
10442A	10:1, 500-ohm 1.2pF oscilloscope probe
10443A	20:1, 1000-ohm, 1.2pF oscilloscope probe

Options for Agilent 16720A Pattern Generator Modules

Agilent Option	Option Description
<ul style="list-style-type: none"> • 011 • 013 • 014 • 015 • 016 • 017 • 018 • 021 • 022 • 023 • 031 • 032 • 033 • 034 • 041 • 042 • 051 • 052 • 0B3 • W17 • W30 • W50 	<ul style="list-style-type: none"> • TTL clock pod and 6" lead set (10460A and 10498A) • 3-state TTL/CMOS data pod and 6" lead set (10462A and 10498A) • TTL data pod and 6" lead set (10461A and 10498A) • 2.5 V clock pod and 6" lead set (10472A and 10498A) • 2.5 V 3-state data pod and 6" lead set (10473A and 10498A) • 3.3 V clock pod and 6" lead set (10477A and 10498A) • 3-state TTL/3.3 V data pod and 6" lead set (10483A and 10498A) • ECL clock pod and 6" lead set (10463A and 10498A) • ECL terminated pod and 6" lead set (10464A and 10498A) • ECL unterminated pod and 50 Ω shield coaxial lead set (10465A and 10347A) • 5 V PECL clock pod and 6" lead set (10468A and 10498A) • 5 V PECL data pod and 6" lead set (10469A and 10498A) • 3.3 V LVPECL clock pod and 6" lead set (10470A and 10498A) • 3.3 V LVPECL data pod and 6" lead set (10471A and 10498A) • 1.8 V clock pod and 6" lead set (10475 and 10498A) • 1.8 V 3-state data pod and 6" lead set (10476 and 10498A) • LVDS clock pod and 6" LVDS lead set (E8140A and E8142A) • LVDS data pod and 6" LVDS lead set (E8141A and E8142A) • Add service manual • Convert to one-year on-site warranty • 3 years return for repair service • 5 years return for repair service

Ordering Information

Accessories for Agilent 16720A Pattern Generator Modules

Accessories Model Number	Description	Accessories Model Number	Description
10460A	TTL clock pod	10476A	3-state 1.8 volt data pod
10461A	TTL data pod	10477A	3.3 volt clock pod
10462A	3-state TTL/CMOS data pod	10483A	3-state TTL/3.3 volt data pod
10463A	10463A ECL clock pod	10498A	8-channel probe lead set, 6" long
10464A	ECL data pod (terminated)	10347A	8-channel 50-ohm shielded coaxial probe lead set
10465A	ECL data pod (unterminated)	5090-4356	Grabbers, surface mount, package of 20
10466A	3-state TTL/3.3V data pod	5959-0288	Grabbers, through hole, package of 20
10468A	5 volt PECL clock pod	10211A	IC probe clip, 24-pin dual in-line package
10469A	5 volt PECL data pod	10024A	IC probe clip, 16 pin dual in-line package
10470A	3.3 volt LVPECL clock pod	E2421A	SOIC clip adapter test kit (Pomona 5514)
10471A	3.3 volt LVPECL data pod	E2422A	Quad clip adapter test kit (Pomona 5515)
10472A	2.5 volt clock pod	E8140A	LVDS clock pod
10473A	3-state 2.5 volt data pod	E8141A	LVDS data pod
10474A	8-channel probe lead set, 12" long	E8142A	LVDS lead set
10475A	1.8 volt clock pod		

Product Numbers and Option(s) for Agilent 16700 Series Post-Processing Tool Sets

Product or Option Number	Description
B4600B	<ul style="list-style-type: none"> • System Performance Analysis (SPA) Tool Set • Serial Analysis Tool Set • Tool Development Kit • Source Correlation Tool Set • Data Communications Tool Set
B4601B	
B4605B	
B4620B	
B4640B	

Available for all Tool Sets

#0D4	Do not install tool set (instructs factory to ship tool set separately from any 16700 Series system on the order)
------	---

Third-Party Solutions

Our solutions partners offer a wide array of accessory products for the Agilent Technologies logic analysis systems. Agilent's solution partners offer complementary products covering probing clips, specialized analysis probes for over 200 microprocessors, and software tools for ASIC emulation and test system design.

See the *Processor and Bus Support For Agilent Technologies Logic Analyzers* (p/n 5966-4365) document for contact information concerning these vendors.

Solutions Partner	Application Focus	Contact Information
Advanced Logic Design (ALD)	Product design services (digital)	www.ald.com
Aptix	ASIC emulation	www.apnix.com
JM Engineering (JME)	Probing (solutions for SMT parts)	www.jmecorp.com
American Arium	Intel emulators and probes	www.arium.com
Advanced RISC Machines (ARM)	Microprocessor core IP	www.arm.com
CAD-UL	Software programming tools	www.cadul.com
Corelis	Analysis probes for various microprocessors and buses	www.corelis.com
Diagonal	Manufacturing test suite software	www.diagonal.com
Emulation Technologies (ET)	Probing	www.emulation.com
Europe Technologies	Embedded system design tools and services	www.europe-technologies.com
FuturePlus Systems	Analysis probes for computer buses	www.futureplus.com
Green Hills Software, Inc (GHS)	Debugger and compiler software for Motorola microprocessors	www.ghs.com
Ironwood	High-density VLSI interconnect solutions	www.ironwoodelectronics.com
Lital Electronics, Inc.	Mil-spec computer boards	www.lital.com
Mobile Media Research	PCMCIA focused development tools	www.mobmedres.com
Microtec (Mentor Graphics Embedded Software Division)	Debuggers and compilers	www.mentor.com/embedded
Pomona Electronics	Supplier of accessories for electronic test instruments	www.pomonaelectronics.com
DIAB-SDS	Debuggers, compilers	www.diabsds.com
Skyline	Probing and manufacturing services	phone only: 719-390-9425
SynaptiCAD	Waveform simulation analysis software	www.syncad.com
WindRiver	Embedded RTOS development tools	www.windriver.com

Support, Warranty and Related Literature

Support and Services

Agilent's support services complement your logic analysis system to provide a complete solution to your digital design and debug problems. By taking advantage of Agilent's expertise you can concentrate on your particular design projects and applications, rather than your debug tools, resulting in increased productivity.

Warranty

Agilent hardware products are warranted against defects in materials and workmanship for a period of one year from date of shipment. Some newly manufactured Agilent products may contain remanufactured parts, which are equivalent to new in performance. If you send us a notice of such defects during the warranty period, we will either repair or replace hardware products that prove to be defective.

Agilent software and firmware products that are designated by Agilent for use with a hardware product are warranted for a period of one year from date of shipment to execute their programming instructions when properly installed. If you send us notice of defects in materials or workmanship during the warranty period, we will repair or replace these products, so long as the defect does not result from buyer supplied hardware or interfacing. The warranty period is controlled by the warranty statement included with the product and begins on the date of shipment.

Related Literature

Publication Title	Publication Type	Publication Number
Processor and Bus Support For Agilent Technologies Logic Analyzers	Configuration Guide	5966-4365E
Probing Solutions for Agilent Technologies Logic Analysis Systems	Product Overview	5968-4632E
Emulation and Analysis Solutions for the Motorola MPC 8XX Microprocessors	Product Overview	5966-2866E
Emulation and Analysis Solutions for the Motorola/IBM PowerPC 6XX Microprocessors	Product Overview	5966-2868E
Emulation and Analysis Solutions for the Motorola/IBM Power PC 740/750 Microprocessors	Product Overview	5966-2867E
Agilent E2487C Analysis Probe & Agilent E2492B/C/E Probe Adapter for Intel Celeron Pentium II/III and Pentium II/III Xeon Processors	Product Overview	5968-2421E
Emulation and Analysis Solutions for ARM7 and ARM9 Microprocessors	Product Overview	5966-3442E

Agilent Technologies' Test and Measurement Support, Services, and Assistance

Agilent Technologies aims to maximize the value you receive, while minimizing your risk and problems. We strive to ensure that you get the test and measurement capabilities you paid for and obtain the support you need. Our extensive support resources and services can help you choose the right Agilent products for your applications and apply them successfully. Every instrument and system we sell has a global warranty. Support is available for at least five years beyond the production life of the product. Two concepts underlie Agilent's overall support policy: "Our Promise" and "Your Advantage."

Our Promise

Our Promise means your Agilent test and measurement equipment will meet its advertised performance and functionality. When you are choosing new equipment, we will help you with product information, including realistic performance specifications and practical recommendations from experienced test engineers. When you use Agilent equipment, we can verify that it works properly, help with product operation, and provide basic measurement assistance for the use of specified capabilities, at no extra cost upon request. Many self-help tools are available.

Your Advantage

Your Advantage means that Agilent offers a wide range of additional expert test and measurement services, which you can purchase according to your unique technical and business needs. Solve problems efficiently and gain a competitive edge by contracting with us for calibration, extra-cost upgrades, out-of-warranty repairs, and on-site education and training, as well as design, system integration, project management, and other professional engineering services. Experienced Agilent engineers and technicians worldwide can help you maximize your productivity, optimize the return on investment of your Agilent instruments and systems, and obtain dependable measurement accuracy for the life of those products.

Agilent T&M Software and Connectivity

Agilent's Test and Measurement software and connectivity products, solutions and developer network allows you to take time out of connecting your instruments to your computer with tools based on PC standards, so you can focus on your tasks, not on your connections. Visit www.agilent.com/find/connectivity for more information.



Agilent Email Updates

www.agilent.com/find/emailupdates

Get the latest information on the products and applications you select.

Microsoft is a U.S. registered trademark of Microsoft Corporation.
Netscape is a U.S. trademark of Netscape Corporation.
Windows and Windows NT are U.S. registered trademarks of Microsoft Corporation.
Pentium is a U.S. registered trademark of Intel Corporation.
UNIX is a registered trademark of the Open Foundation.
PostScript is a registered trademark of Adobe Systems.

By internet, phone, or fax, get assistance with all your test & measurement needs

Online assistance:
www.agilent.com/find/assist

**Phone or Fax
United States:**
(tel) 800 452 4844

Canada:
(tel) 877 894 4414
(fax) 905 282 6495

China:
(tel) 800 810 0189
(fax) 800 820 2816

Europe:
(tel) (31 20) 547 2323
(fax) (31 20) 547 2390

Japan:
(tel) (81) 426 56 7832
(fax) (81) 426 56 7840

Korea:
(tel) (82 2) 2004 5004
(fax) (82 2) 2004 5115

Latin America:
(tel) (305) 269 7500
(fax) (305) 269 7599

Taiwan:
(tel) 0800 047 866
(fax) 0800 286 331

Other Asia Pacific Countries:
(tel) (65) 6375 8100
(fax) (65) 6836 0252
Email: tm_asia@agilent.com

Product specifications and descriptions in this document subject to change without notice.

© Agilent Technologies, Inc. 2002
Printed in USA June 25, 2002
5968-9661E

Free Manuals Download Website

<http://myh66.com>

<http://usermanuals.us>

<http://www.somanuals.com>

<http://www.4manuals.cc>

<http://www.manual-lib.com>

<http://www.404manual.com>

<http://www.luxmanual.com>

<http://aubethermostatmanual.com>

Golf course search by state

<http://golfingnear.com>

Email search by domain

<http://emailbydomain.com>

Auto manuals search

<http://auto.somanuals.com>

TV manuals search

<http://tv.somanuals.com>