

# INSTALLATION & OPERATION MANUAL

Digital Video Recorder  
DVR-3704T

  
**APPRO**<sup>®</sup>









Before trying to connect or operate this product, please read this manual completely



## SAFETY PRECAUTIONS



All the following safety and operation instructions for the prevention of harm or damage to the operator or other persons should be read before the unit is operated.

### WARNING

-  To reduce the risk of fire or electric shock, do not expose this appliance to rain or moisture.
-  Do not block ventilation openings.
-  Do not place anything on top of the unit that might spill or fall into it.
-  Do not attempt to service this unit yourself as opening or removing covers may expose you to dangerous voltage or other hazards. Please refer all servicing to qualified service personnel.
-  Do not use liquid cleaners or aerosols for cleaning.
-  This installation should be done by a qualified service person and should conform to all local codes.
-  To prevent fire or electric shock, do not overload wall outlets or extension cords.
-  This unit must be grounded to reduce the risk of electric shock hazard.

### CAUTION

#### HDD:

-  Please don't use the hard disk(s) you have employed with a particular model of the DVR (in recording and playing back data) with any other model of DVR, for you will lose the data you have stored in the hard disk(s) if you do so. You are free to use the same hard disks between DVRs belonging to a single model.
- Danger of explosion if the Lithium battery (RTC Battery) is incorrectly replaced.**
-  Danger of explosion if battery is incorrectly replaced. Replace only with the same or equivalent type recommended by the manufacturer. Dispose of used batteries according to the manufacturer's instructions.
  -  Risk of explosion if replaced by an incorrect type. Dispose of used batteries according to the instructions.

### INFORMATION

This equipment has been tested and found to comply with the limits for a Class B digital device, pursuant to Part 15 of the FCC Rules. These limits are designed to provide reasonable protection against harmful interference when the equipment is operated in a commercial environment. This equipment generates, uses, and can radiate radio frequency energy and, if not installed and used in accordance with the instruction manual, may cause harmful interference with radio communications. Operation of this equipment in a residential area is likely to cause harmful interference in which case the user will be required to correct the interference at his own expense.

# Table Of Contents

<b>1. PRODUCT FEATURES .....</b>	<b>4</b>
1.1 <i>PRODUCT INTRODUCTION</i> .....	4
1.2 <i>PRODUCT FEATURES</i> .....	4
<b>2. DESCRIPTION OF THE FRONT/REAR VIEW.....</b>	<b>6</b>
2.1 <i>FRONT VIEW</i> .....	6
2.2 <i>REAR VIEW</i> .....	9
2.3 <i>ALARM In/Out</i> .....	10
<b>3. BASIC OPERATIONS .....</b>	<b>11</b>
3.1 <i>RECORDING OPERATIONS</i> .....	11
3.1.1 <i>Manual Recording</i> .....	11
3.1.2 <i>Alarm Recording</i> .....	11
3.1.3 <i>Timer Recording</i> .....	12
3.2 <i>PLAYBACK OPERATIONS</i> .....	13
3.2.1 <i>Fast Forward/Reverse</i> .....	13
3.2.2 <i>Playback Picture-by-picture</i> .....	13
3.3 <i>BACKUP OPERATIONS</i> .....	14
3.4 <i>KEY LOCK OPERATIONS</i> .....	15
3.5 <i>TRIPLEX OPERATIONS</i> .....	15
<b>4. SEARCH MODE .....</b>	<b>16</b>
4.1 <i>RECORD LIST</i> .....	16
4.2 <i>ALARM LIST</i> .....	16
4.3 <i>TIME FILTER</i> .....	17
<b>5. MENU MODE .....</b>	<b>18</b>
5.1 <i>QUICK SETTING</i> .....	19
5.2 <i>DISPLAY OPTION</i> .....	20
5.3 <i>SEQUENCE SETTING</i> .....	21
5.4 <i>ADJUST PICTURE</i> .....	21
5.5 <i>ADVANCED SETTING</i> .....	22
5.5.1 <i>RECORD SETTING</i> .....	22
5.5.2 <i>ALARM SETTING</i> .....	23
5.5.3 <i>MOTION SETTING</i> .....	24
5.5.4 <i>NETWORK SETTING</i> .....	25

5.5.5 SCHEDULE SETTING .....	26
5.6 DISK SETUP.....	27
5.7 SYSTEM SETTING.....	28
<b>6. DISPLAY MODE.....</b>	<b>29</b>
<b>7. NETWORK VIEWER: INTRODUCTION.....</b>	<b>30</b>
7.1 TCP/IP COMMUNICATION SETUP .....	30
7.2 CONNECTION TESTING.....	33
7.3 SOFTWARE INSTALLATION.....	34
7.4 VIEW THE DVR VIDEO FROM A REMOTE PC.....	37
7.5 OPERATION.....	39
<b>8. SPECIFICATIONS .....</b>	<b>42</b>
<b>APPENDIX 1. – Insert the mobile rack.....</b>	<b>43</b>
<b>APPENDIX 2. – RS-232 Connection.....</b>	<b>44</b>
<b>APPENDIX 3. – Compatible SATA hard-disk drives .....</b>	<b>45</b>

# **1. PRODUCT FEATURES**

## **1.1 PRODUCT INTRODUCTION**

The **DVR-3704** is a unique low-cost, high-performance digital video recorder supporting a 4-channel video input, 4 alarm inputs and one alarm output. It records at a real time speed, and displays video at the same speed rate per channel. Our device is capable of simultaneous triplex recording, playback and live modes, and provides a multi-screen on which to view your recorded images. Instead of having to handle inconvenient VCR tapes, you now have the hard-disk drive in which to store your videos, enabling you to enjoy the extreme flexibility of digital image archiving. You can access the images from any of your four channels rapidly and smoothly whenever you wish.

In your recordings you can set different speed rates, qualities and resolutions as you choose, and when you're looking for some particular records, you can use the search functions to search through your records by record list, alarm list or time filter. You can play back your selected items directly, and save the crucial images to a USB device which you can transfer to your PC to play and print out.

Our digital video recorder further supports the network function in which you can use a remote PC to connect with the DVR and retrieve vital images from a hard disk. You will be able to access both video and audio records effortlessly. Use our device to bring your total environment under your complete surveillance, archiving and control.

## **1.2 PRODUCT FEATURES**





- Non-PC based DSP hardware with proprietary system firmware.
- Operation status LEDs.
- Full triplex operation with simultaneous Live, Play, Record and remote Network operations.
- Live refresh rate up to 120 field/sec for 360x240 pixels (NTSC) or 100 field/sec for 360x288 pixels (PAL).
- Compression: Motion JPEG.
- Live viewing modes: 2X digital zoom.
- Recording speed up to 60 field/sec for NTSC (50 field/sec for PAL).
- Multiple recording modes: Manual/ Alarm/ Circular/ Timer recording.
- Full triplex operation allows live viewing/ video recording/ playback and network access simultaneously.
- Supports in both a forward and a backward direction, as well as step by step.
- Fast and slow playback of recorded video at various speeds.  
Fast forward and reverse (2x, 4x, 8x, 16x).
- Individual sensor alarm, video loss alarm & motion detection alarm for each channel.

- Easy field firmware update via USB device can be performed by the end user.
- Built-in USB connector to save image(s) for an individual channel to an USB device.
- 4 BNC video input channels.
- 4 alarm inputs and 1 alarm output.
- Audio recording.
- Quick setup menu.
- Disk-full warning.
- Supports factory default menu setting.
- Supports Play/Reverse-Play/Pause/Stop/FF/REW for playback.

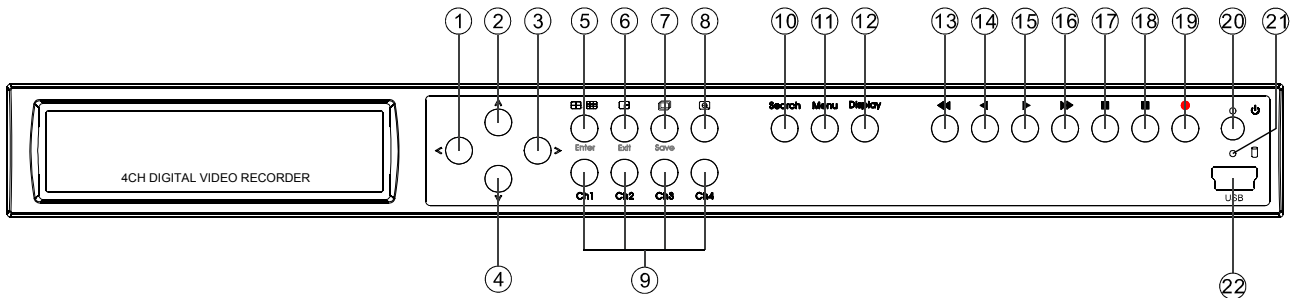





## 2. DESCRIPTION OF THE FRONT/REAR VIEW



### 2.1 FRONT VIEW



- ① **<** button:  
Press to move the focus to desired items in the menu setup mode.
- ② **>** button:  
Press to move the focus to desired items in the menu setup mode.
- ③ **^** button:  
Press to move within a desired option or value in the setup mode in the upward direction.
- ④ **v** button:  
Press to move within a desired option or value in the setup mode in the downward direction.  
Press the “v” button to activate/deactivate the key lock function (refer to section 3.4).
- ⑤ **Enter** (  /  ) button:  
Press to enter a selected item in the menu setup mode.  
In both the live and play modes, press twice successively to get two multi-channel modes on the main monitor, the first time in a 4-way vision, and the last in a 9-way mode.
- ⑥ **Exit** /  **PIP** button:  
Press to exit the menu setup mode.  
The  button is used to select video modes and video channels. In the **Live / Record** mode, press this button to loop the picture-in-picture modes in turns.  
**Note: Press the button for at least 3 seconds to enter a single channel with one, two or three insets of the channels and highlight the channel to exchange the video sources. Press the button for at least 3 seconds to exit the setting.**
- ⑦ **Save** /  button:  
Press to enter the sequential jumping mode, each multi-screen, and one sequence; the picture will sequentially switch to different channels according to the sequence setting in the setup menu.



- ⑧  button:  
Press to double the size of an image. Use the "^" ( up ), "V" ( down ) , "<" ( left ) and ">" ( right ) buttons to shift your zoom focus . Press the  button again or press the **Display** button to return to the original image size.
- ⑨ **channel** buttons:  
All channel buttons from 1 to 4 are sited here. Press each to display its channel in the live and play modes.
- ⑩ **Search** button:  
Press to enter the search mode to access recorded video.
- ⑪ **Menu** button:  
Press this to enter the setup menu.
- ⑫ **Display** button:  
Press to display the status of the hard disks, the USB flash memory, the record setting and the network setting in your device.
- ⑬  button:  
Press to play a recorded video in the reverse direction at faster speeds than the recorded speed and the LED will emit green light.  
During the freeze, press to display one image of a picture at a time in the backward direction.
- ⑭  button:  
Press to play a recorded video in the forward direction at faster speeds than the recorded speed and the LED will emit green light.  
During the freeze, press to display one image of a picture at a time in the forward direction.
- ⑮  button:  
Press to play back a recorded video in the reverse direction from the hard disk and the LED will emit green light.
- ⑯  button:  
Press to play back a recorded video in the forward direction from the hard disk and the LED will emit green light.
- ⑰  button:  
In a playback display, press this to freeze the display and the LED will emit green light. During the freeze, press to display one image of a picture at a time in the forward direction.

- ⑱  (Stop) button:  
Press to stop playing back a recorded video from a hard disk and the LED will emit green light.
- ⑲  button:  
Press to start recording video into a hard disk while in the live display mode and the LED will emit green light. Press again for at least 3 seconds to stop the recording.
- ⑳ **POWER** button:  
Press this button for at least 3 seconds to switch off. Press again to activate the device.
- ㉑  (disk) Indicator:  
The indicator shows the operation status of the unit's hard-disk drives. The green light indicates the hard-disk drive is storing or retrieving data.
- ㉒ **USB** port:  
This is used for system software updating and archiving/accessing critical images.

**Note:** When turning on the DVR, a message of “**SYSTEM INITIALIZING**” will appear. The user can press and hold the “**A**” button to change to the **PAL** system; or press and hold the “**v**” button to change to the **NTSC** system.

## 2.2 REAR VIEW

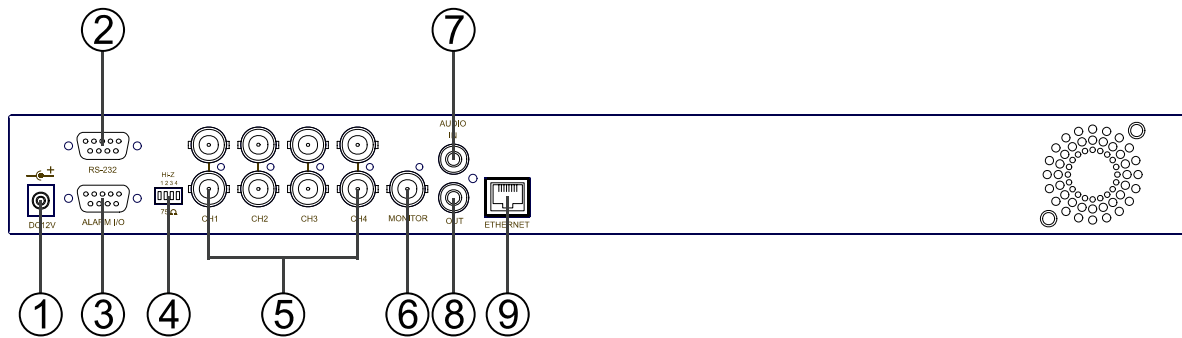

① **DC jack:**

The inlet connects to an external power supply. Connect with the 12 V DC TUV-approved Power Supply; or connect with the UL Listed Class 2 Power Supply or ITE power supply marked 'LPS' or its equivalent.

② **RS-232 Port:**

The RS-232 communication port functions as a connector to an external control device. Please refer to the **RS-232 Connection** for more details.

③ **ALARM I/O:**

This is a 9-PIN D-SUB connector including **GROUND, ALARM OUT, DISK FULL, RECORD IN, ALARM RESET**, and **ALARM IN** for connecting with external devices. Please refer to the next section (ALARM In/Out) for details.

④ **75Ω/Hi-Z Individual termination:**

These 4 switches are used to set the impedance of each loop through output connectors (31) between 75Ω and Hi-Z. Toggle the corresponding impedance termination to the Hi-Z position if another device is connected to the video loop through the connector. Set the impedance to the 75Ω position if no other device is connected to the corresponding loop through the connector. The default setting is 75 Ω.

⑤ **Video in connectors (Ch1~Ch4) & Video loop through connectors (Ch1~Ch4):**

These 4 BNC connectors are used to connect to the video output from the cameras. 4 cameras can be connected to these connectors.

These 4 BNC connectors are used to loop video signals from each camera out to other devices.

⑥ **Monitor connector:**

This BNC connector provides a video signal controlled by the control buttons in the front panel to the main monitor. This connector transmits the video display in full-screen format, multi-screen format and sequential format.

⑦ **AUDIO IN Connector:**

This connector is used to connect the audio output from a camera or other devices to the 4CH DVR.

⑧ **AUDIO OUT:**

This connector provides the unit's audio signal to a speaker or stereo.

⑨ **ETHERNET 10/100 Connector:**

This is a standard RJ-45 connector for the 10/100 Mbps Ethernet networks.

## 2.3 ALARM In/Out

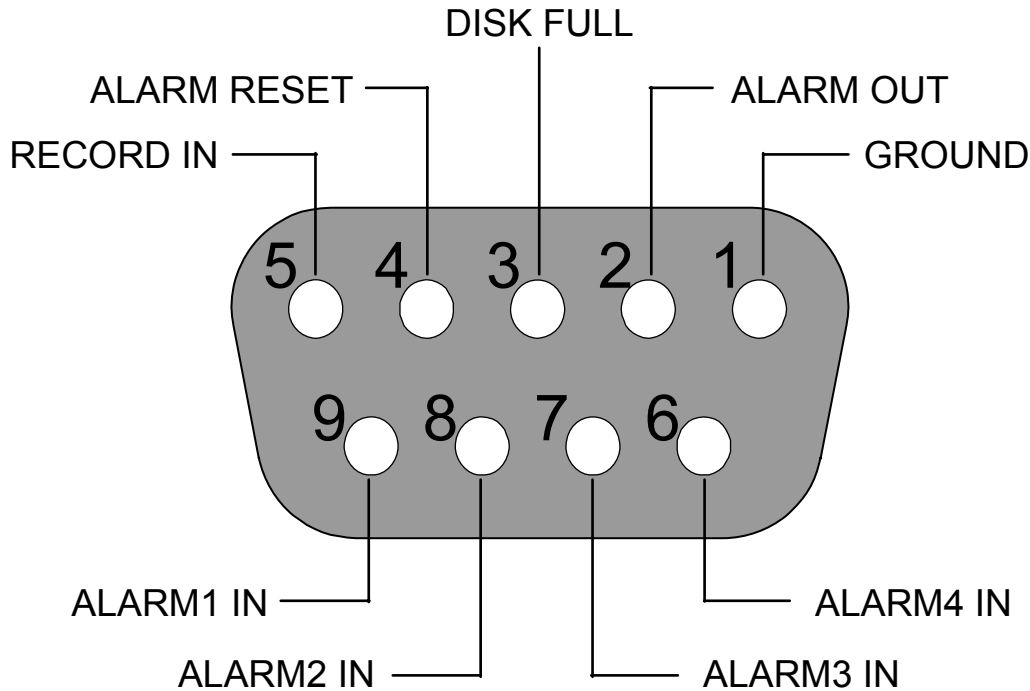



THE ABOVE FIGURE IS A REAR VIEW.

1. **GND:** Ground Contact.

2. **ALARM OUT (OUTPUT):** This is an alarm-output trigger. Connect this to external devices such as buzzers or lights. (  ..... 5V  
0V(Active) )

3. **DISK FULL (OUTPUT):** This is a disk-full output trigger. Connect this to external devices such as buzzers or lights. (  ..... 5V  
0V(Active) )

4. **ALARM RESET (INPUT):** This pin connects to an alarm-clear device for clearing an alarm. (  ..... 5V  
0V(Active) )

5. **RECORD IN (INPUT):** This pin connects to a record-triggering device for starting a record. (  ..... 5V  
0V(Active) )

6. **ALARM4 IN (INPUT):** This is an alarm input( for CH 4 )which can be programmed in the menu system to Normally Open or Normally Closed. (  ..... 5V  
0V(Active) )

7. **ALARM3 IN (INPUT):** same as the above, for CH 3

8. **ALARM2 IN (INPUT):** same as the above, for CH 2

9. **ALARM1 IN (INPUT):** same as the above, for CH 1



### 3. BASIC OPERATIONS

This section shows you how to operate and manage the DVR.

#### 3.1 RECORDING OPERATIONS

##### 3.1.1 Manual Recording

When the DVR is in the live display mode, take the following steps to start recording:

(1) In live display, press the  button to record video into a hard-disk drive with the corresponding programmed recording settings. At once the device will emit a “beeping” sound signal and the  button will light up indicating the DVR is in the recording status.

(2) Press the  button for at least 3 seconds to stop recording any time.

**Note:** In the **SEARCH MENU** and **MAIN MENU**, the user cannot press the  button to lift the record mode.

(3) To access just recorded video, please refer to section **5.5.1 RECORD SETTING** for more details.

##### 3.1.2 Alarm Recording

Take the following steps to activate the programmed alarm recording. For **ALARM** settings, please refer to section 5.5.1 for more details.

(1) Press the **MENU** button to enter the **MAIN MENU**.

(2) Select the **ADVANCED SETTING** and press the **Enter** button to enter the **ADVANCED SETTING** page.

(3) Select the **ALARM SETTING** and press the **Enter** button to enter the **ALARM SETTING** page. (Please refer to section 5.5.1 for more information.)

(4) Enter and set each channel to activate or deactivate the three modes of "SENSOR", "V-LOSS", and "MOTION".

(5) Set the desired time period. Set the "ALARM DURATION" for **0** second, **30** seconds, **1** minute, **5** minutes to **10** minutes or **NONSTOP**.

(6) Activate or deactivate the buzzer sound.

ADVANCED SETTING	
1.RECORD SETTING	ENTER
2.ALARM SETTING	ENTER
3.MOTION SETTING	ENTER
4.NETWORK SETTING	ENTER
5.SCHEDULE SETTING	ENTER



ALARM SETTING			
1.	SENSOR	V-LOSS	MOTION
CH1	OFF	OFF	OFF
CH2	OFF	OFF	OFF
CH3	OFF	OFF	OFF
CH4	OFF	OFF	OFF
2.	ALARM DURATION		00 MIN
3.	BUZZER SOUND		ON

### 3.1.3 Timer Recording

Timer recording provides seven schedules in a weekly table. This way the DVR will start and stop recording according to the programmed schedule. Please take the following steps to program the scheduled recording.

- (1) Press the **MENU** button to enter the **MAIN MENU**.
- (2) Select the **ADVANCED SETTING** and press the **Enter** button to enter the **ADVANCED SETTING** page.
- (3) Select the **SCHEDULE SETTING** and press the **Enter** button to enter the **SCHEDULE SETTING** page.  
(Please refer to section 5.5.5 for more information.)
- (4) Enter and set each single day to activate (ON) or deactivate (OFF) the recording schedule.
- (5) Set the desired recording period. Set the time to begin a recording. Set the time to end a recording.  
**NOTE: You can set each time period between 00:00 and 23:59 (24HR mode).**
- (6) If you want to stop recording in a scheduled recording session or at anytime, you can press the  button for at least 3 seconds.

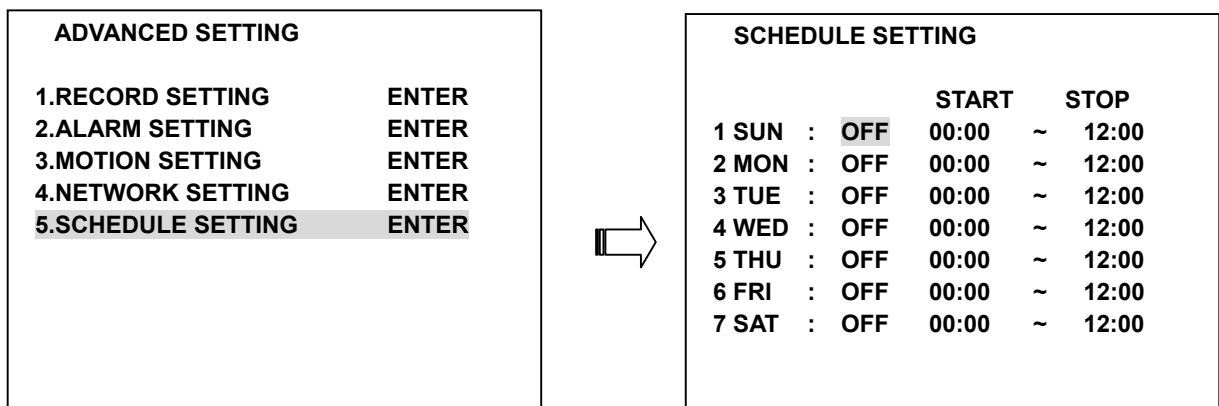

**NOTE: You can proceed to start the scheduled recording from the current time if it is in the scheduled interlude as soon as the setting is complete, and come out from the menu to start recording.**

**NOTE: If you activate the recording function before the scheduled recording, the unit won't operate the timer recording function.**



## 3.2 PLAYBACK OPERATIONS

This section shows you how to operate the fast and single-picture playback functions, and details how the unit is to playback a file in a different operation status. Please refer to the following paragraphs specifying the relevant details. When playing a file, the **PLAY** button will light up indicating that the DVR is in the playback status.

During playback, press the CH1-CH4 buttons to view the corresponding channels. To view the playback of multiple channels simultaneously, press the appropriate /  button. Besides switching between keys, the  button can also be used to zoom the picture to a 2X digital zoom view.



### 3.2.1 Fast Forward/Reverse

There are 4 speeds available for playback: **2x, 4x, 8x and 16x.**

While playing back recorded video at the recorded speed:



**Forward:** Press the  button to view the recorded video in the forward direction at a speed faster than the recorded speed. Press the button to increase the forward rate, as 2x, 4x, 8x or 16x.

**Reverse:** Press the  button to view the recorded video in the reverse direction at a speed faster than the recorded speed. Press the button to increase the forward rate, as 2x, 4x, 8x or 16x.



**Normal:** Press the  or  button to return to the normal speed of playback.

### 3.2.2 Playback Picture-by-picture



While playing back recorded video at the recorded speed:

- (1) Press the **PAUSE** button for the picture-by-picture mode.
- (2) There are two ways, by  button or by  button, to play in the picture-by-picture mode in a forward direction; the other, the  button, can act in a backward direction, as well as picture-by-picture.

**By  or  button:**

Press the  button. Use the  or  button to display one image of a picture at a time in the forward direction.

**By  button:**

Press the  button. Use the  button to display one image of a picture at a time in the backward direction.

- (3) Press the  or  button to return to the normal speed of playback.

## 3.3 BACKUP OPERATIONS

### Archive Single image Clips into a USB device:

Please take the following steps to archive a critical image in a USB device.

- (1) Insert a USB device into the USB slot of the front unit.
- (2) Start playing back the recorded video.
- (3) Press the **II** button to freeze the desired image.
- (4) Press the **Save** button to save the image. While saving the image, the  icon will appear on the screen.

#### Note:

When playing back in the single-channel () display mode, the user can choose the single-channel image s/he likes, and then archives it.

When playing back in the multi-channel () display mode, the user can choose the multi-channel image s/he likes, and then archives it.

#### •USB image:

How many pictures can be stored depends on the capacity of the USB device. The image is stored in the **DVR** format. You can have the saved images shown by our **Network Viewer** software. If more than one clip is stored in a USB device, file names will be assigned in sequence as shown below.

**0608231213270000S.dvr**

**0608231213270001S.dvr**

...

**060823121327NNNNS.dvr**

**(YYMMDDHHMMSS+number).dvr**

**Note: The DVR only supports the USB device which is formatted in the “FAT16” file system and the capacity of the USB must be limited to 2GB. If you use the “FAT32-format” USB device to store the backup images, a PC may not be able to read the backup files.**



### 3.4 KEY LOCK OPERATIONS

- To activate the key lock function:  
Press the “v” button for at least 3 seconds to activate the key lock function. The device will emit a “beeping” sound signal and show the message of “KEY LOCK”.
- To deactivate the key lock function:  
Press the “v” button for at least 3 seconds to deactivate the key lock function. The device will emit a “beeping” sound signal and show the message of “KEY UNLOCK”.

### 3.5 TRIPLEX OPERATIONS

The **Live**, **Play** and **Record** modes act simultaneously to comprise the **Triplex** function. The three modes played together comprise the “Triplex” function.

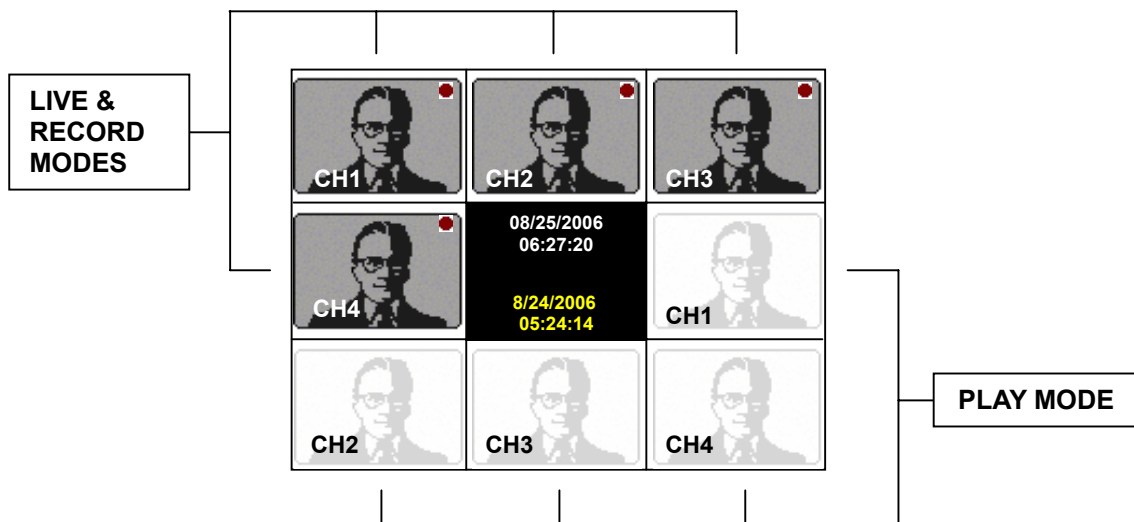

## 4. SEARCH MODE

This section shows you how to access recorded video.

### 4.1 RECORD LIST

Take the following steps to proceed with the record-list search function.

- (1) Press the **Search** button to enter the search mode.
- (2) Select **RECORD LIST** and press the **Enter** button to access the complete list of recorded video.
- (3) Highlight the specific recorded video you require and press the **Enter** button to display the selected video.

(Key Operation: Press the “^” and “v” buttons to select a video; press the “<” or “>” buttons to turn a page. Press the  button to switch the hard disks.)

SEARCH	
1.RECORD LIST	ENTER
2.ALARM LIST	ENTER
3.TIME FILTER	ENTER

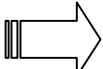

RECORD LIST	HDD:HDD1	0001/0120
START TIME	END TIME	
08/15/2006 09:03	08/15/2006 14:25	
08/14/2006 19:22	08/14/2006 19:25	
08/14/2006 09:30	08/14/2006 16:30	
08/13/2006 11:00	08/13/2006 18:00	
08/12/2006 15:00	08/12/2006 17:20	
08/12/2006 08:03	08/12/2006 14:25	
08/10/2006 07:30	08/10/2006 16:05	
08/09/2006 10:10	08/09/2006 15:25	
08/08/2006 09:10	08/08/2006 14:30	
08/07/2006 08:13	08/07/2006 10:25	

ZOOM KEY: SWICTH HDD

**NOTE:** The maximum number of lists for one HDD is 1000.

### 4.2 ALARM LIST

Take the following steps to proceed with the alarm-list search function.

- (1) Press the **Search** button to enter the search mode.
- (2) Select the **ALARM LIST** and press the **Enter** button to access the complete list of alarm-event recorded video.
- (3) Highlight the specific recorded video you require and press the **Enter** button to display the selected video.

(Key Operation: Press the “^” and “v” buttons to select a video; press the “<” or “>” buttons to turn a page. Press the  button to switch the hard disks.)

SEARCH	
1.RECORD LIST	ENTER
2.ALARM LIST	ENTER
3.TIME FILTER	ENTER

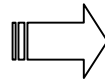

ALARM LIST			HDD:HDD1	0001/0120
START TIME	EVENT	CH		
08/15/2006 09:03	MOTION	CH1		
08/14/2006 19:22	MOTION	CH1		
08/14/2006 09:30	MOTION	CH1		
08/13/2006 11:00	MOTION	CH2		
08/12/2006 15:00	MOTION	CH1		
08/12/2006 08:03	MOTION	CH3		
08/10/2006 07:30	MOTION	CH1		
08/09/2006 10:10	MOTION	CH1		
08/08/2006 09:10	MOTION	CH4		
08/07/2006 08:13	MOTION	CH1		

ZOOM KEY: SWICTH HDD

### 4.3 TIME FILTER

Take the following steps to proceed with the time-list search function.

- (1) Press the **Search** button to enter the search mode.
- (2) Select the **TIME FILTER** and press the **Enter** button to access the **TIME FILTER** page.
- (3) Set the date/time period you wish to search for the recorded video.
- (4) Press the **Enter** button to search and play the recorded video.
- (5) If no video is found, please return to the **TIME FILTER** page and repeat steps (3) and (4) again for another search.

SEARCH	
1.RECORD LIST	ENTER
2.ALARM LIST	ENTER
3.TIME FILTER	ENTER

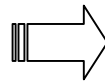

TIME FLITER		HDD:HDD1
START	:	08/11/2006 15:35
END	:	08/15/2006 14:24
		08/18/2006 08:16

ENTER KEY: START TO SEARCH  
ZOOM KEY : SWICTH HDD

## **5. MENU MODE**

There are 7 functional items for setting operations in the setup menu system as shown below. The following sections will instruct you step by step to configure setting the operations, and will state each item's purpose and options. You can also use the “**^**” (up) and “**v**” (down) buttons to select any of the items. Once inside the item's system, the on-screen menu allows you to set up the key features of the unit. The functions of the various buttons within the menu-setup mode are described in the paragraphs below.

<b>MAIN MENU</b>	
<b>1.QUICK SETTING</b>	<b>ENTER</b>
<b>2.DISPLAY OPTION</b>	<b>ENTER</b>
<b>3.SEQUENCE SETTING</b>	<b>ENTER</b>
<b>4.PICTURE ADJUST</b>	<b>ENTER</b>
<b>5.ADVANCED SETTING</b>	<b>ENTER</b>
<b>6.DISK SETUP</b>	<b>ENTER</b>
<b>7.SYSTEM SETTING</b>	<b>ENTER</b>

### **KEY FUNCTIONS:**

**MENU** button:

Press to enter the **MAIN MENU** page. You can also use this button to return directly to the **MAIN MENU** page from any other page. After returning to the **MAIN MENU** page, you can push the MENU button again to exit the menu system with saving.

“**^**” and “**v**” buttons:

Press to move within a desired option or value.

“**<**” and “**>**” buttons:

Press to select a desired item.

**Enter** button:

Press to enter a selected item.

## 5.1 QUICK SETTING

This page enables you to rapidly install your desired setting. For more detailed changes, enter each item page.

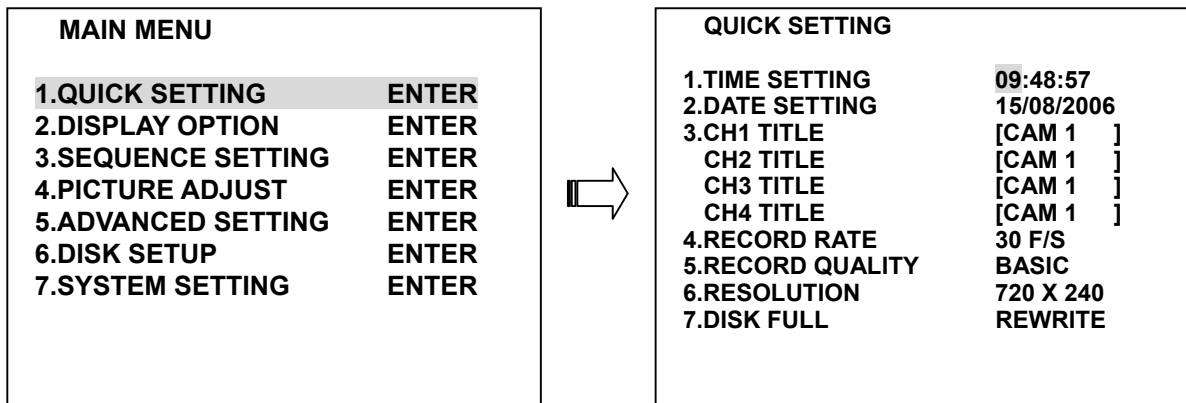

### 1. TIME SETTING:

You can set the system time here.

### 2. DATE SETTING:

You can set the system date here.

### 3. TITLE SETTING:

Fixes a desired title within 8 characters for each channel. Please choose the particular channel's title, then press the "Enter" button, and use the "▲" and "▼" buttons to make any changes.

For example, you can fix channel 1 from the default setting "CAM 1" to "CH1 EXIT".

### 4. RECORD RATE:

Select this item and use the "▲" and "▼" buttons to adjust your recording rate out of our available rate from 1, 2, 3, 5, 10, 15, 30 and 60 (NTSC), or 1, 2, 3, 5, 8, 12, 25 and 50 (PAL).

### 5. RECORD QUALITY:

Choose the quality out of a quality range from "BASIC", "STANDARD" and "HIGH" to "BEST".

### 6. RESOLUTION:

This option determines the resolution of recording. The resolution is **720 x 240** pixels or **360 x 240** pixels (NTSC) and **720 x 288** pixels or **360 x 288** pixels (PAL).

**Note:** When the **RESOLUTION** is set in the **360 x 240 (360 x 288)** pixels, the **RECORD RATE** will be fixed in **120 F/S** (NTSC) and **100 F/S** (PAL) and cannot be changed.

### 7. DISK FULL:

This option determines the way to utilize storage media in case of a full disk.

**REWRITE:** When the hard disk is full, the device continues recording by displacing the old data.

**STOP:** When the hard disk is full, the device will stop recording.

**NOTE:** Please press the any button to erase the beeping sound.

## 5.2 DISPLAY OPTION

This item enables you to fix the display labels on your screen.

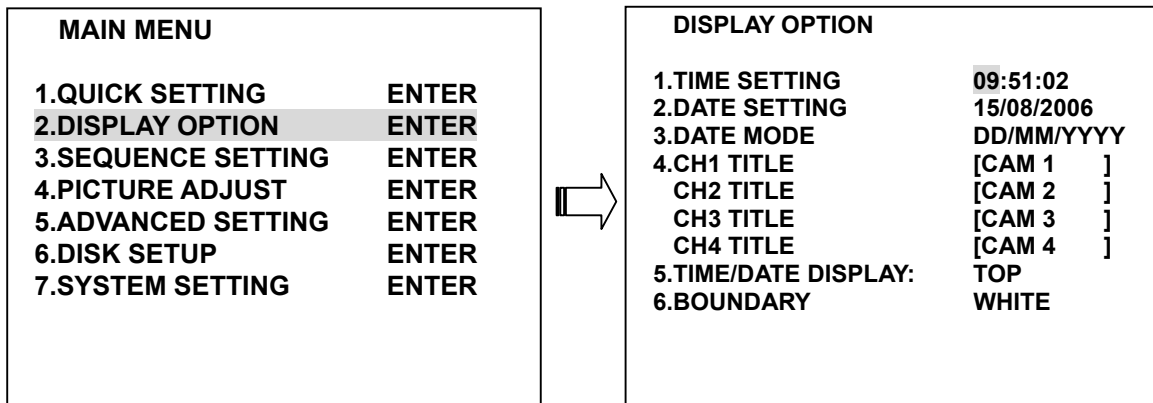

### 1. TIME SETTING:

You can set the system time here.

### 2. DATE SETTING:

You can set the system date here.

### 3. DATE MODE:

Gives a date in terms of months, days, or years, in the following 3 alternative formats:

“DD/MM/YYYY”, “YYYY/MM/DD” and “MM/DD/YYYY”.

### 4. TITLE SETTING:

Fixes a desired title within 8 characters for each channel. Please choose the particular channel's title, then press the **Enter** button, and use the “^” and “v” buttons to make any changes.

For example, you can fix channel 1 from the default setting “CAM 1” to “CH1 EXIT”.



### 5. TIME/DATE DISPLAY:

You can locate/change time/date labels in two positions: “**TOP**” and “**BOT**” (bottom) or select “**OFF**” to hide.

### 6. BOUNDARY:

You can choose between **WHITE**, **BLACK** and **GRAY** to change the boundary color.



### 5.3 SEQUENCE SETTING

This page enables you to set the dwell time for displays in each channel and the 4-windows (  ) mode at your own preference anywhere between 0 (no-show) and 90 seconds when you press the  button.

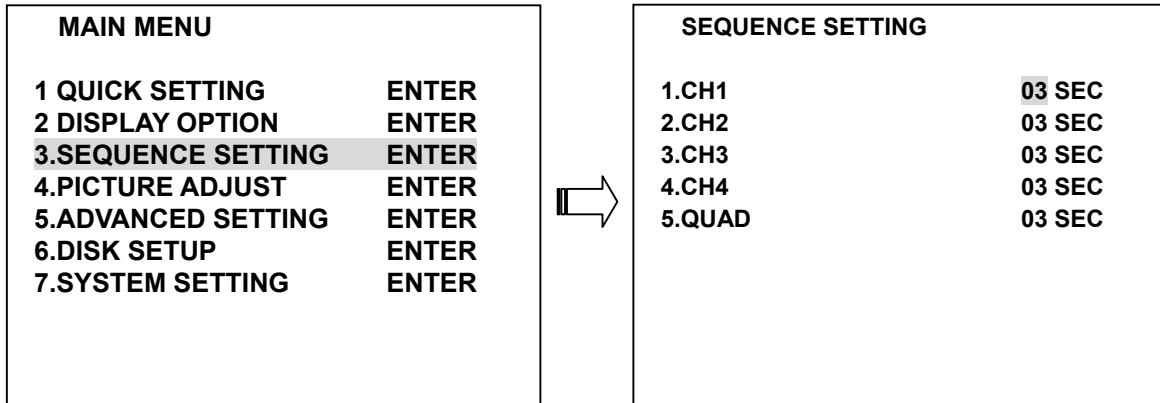
**Note:** The  button only works in the **Live** and **Record** modes.



Please choose the item, and then use the “A” and “v” buttons to make any changes.

**Note:** In the Live/Record mode, press the  button to start the sequence display mode (  then loop back) and the  icon will show on the screen simultaneously.

### 5.4 ADJUST PICTURE

This page enables you to position your images the way you desire.

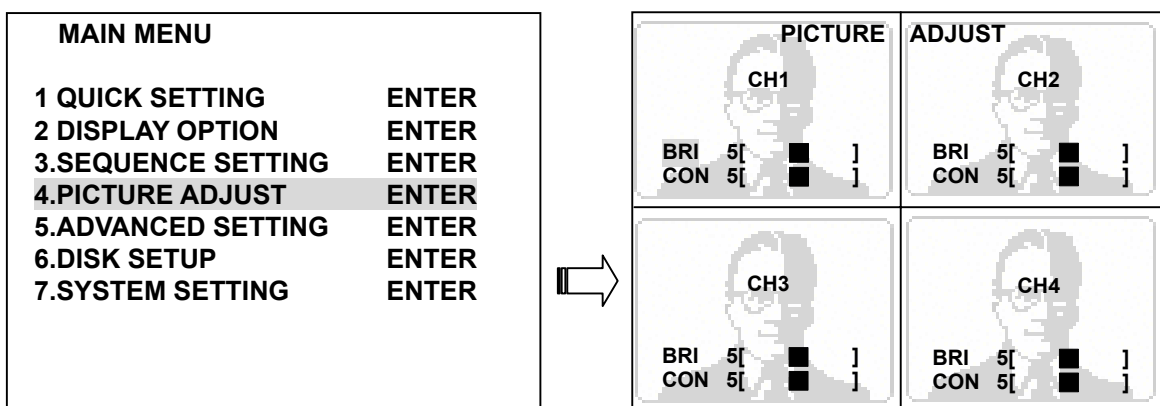

You can use the “A” and “v” buttons to adjust the **BRI** (brightness) and **CON** (contrast) properties of the live images in each channel.

## 5.5 ADVANCED SETTING

This page includes multiple special functions.

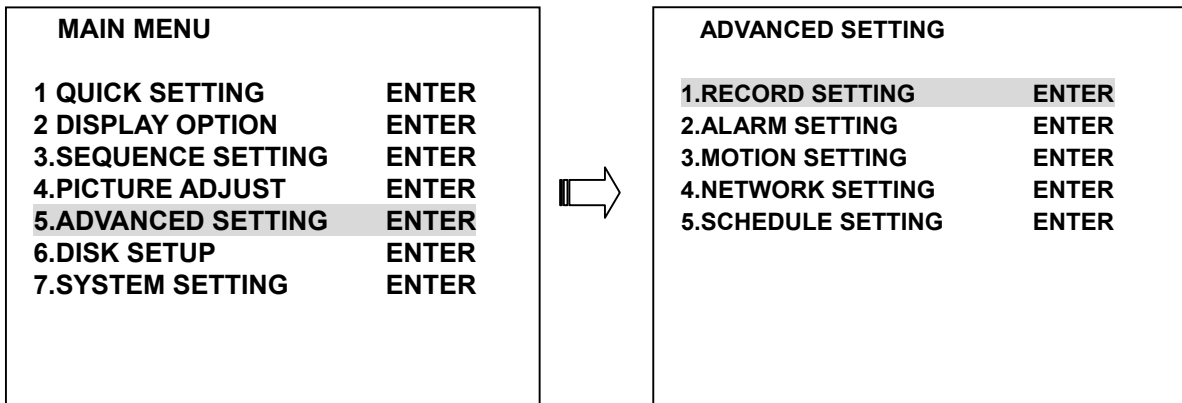

### 5.5.1 RECORD SETTING

This page enables you to set the recording rate, recording quality, and resolution, and enables you to activate the rewrite function and set the audio.

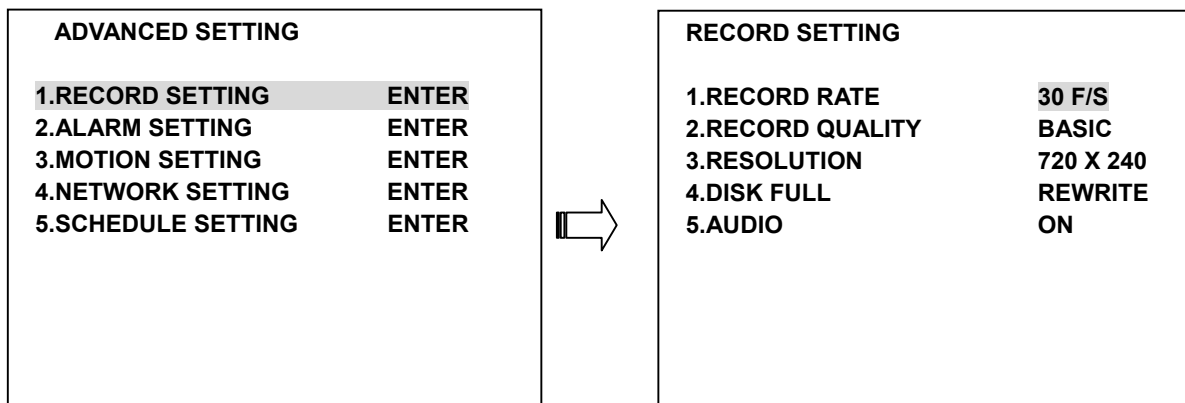

#### 1. RECORD RATE:

Select this item and use the “^” and “v” buttons to adjust your recording rate out of our available rates of 1, 2, 3, 5, 10, 15, 30 and 60 (NTSC), or 1, 2, 3, 5, 8, 12, 25 and 50 (PAL).

#### 2. RECORD QUALITY:

You can choose quality at 4 different levels of recording images from "BASIC", "STANDARD" and "HIGH" to "BEST".

#### 3. RESOLUTION:

This option determines the resolution of recording. The resolution is **720 x 240** pixels or **360 x 240** pixels (NTSC) and **720 x 288** pixels or **360 x 288** pixels (PAL).

**Note:** When the **RESOLUTION** is set in the **360 x 240 (360 x 288)** pixels, the **RECORD RATE** will be fixed in **120 F/S** (NTSC) and **100 F/S** (PAL) and cannot be changed.

#### 4. DISK FULL:

This option determines the way to utilize storage media in case of a full disk.

**REWRITE:** When the hard disk is full, the device continues recording by displacing the old data.

**STOP:** When the hard disk is full, the device will stop recording.



## 5. AUDIO:

This item has 2 options: "ON" and "OFF" (disable).

**Note:** When the recording rate is set under 5 F/S (the lower recording rate), the Audio function will be turn off (disabled) automatically.

### 5.5.2 ALARM SETTING

This page enables you to set all the various alarm - related functions. The device will record as long as the alarm is activating.

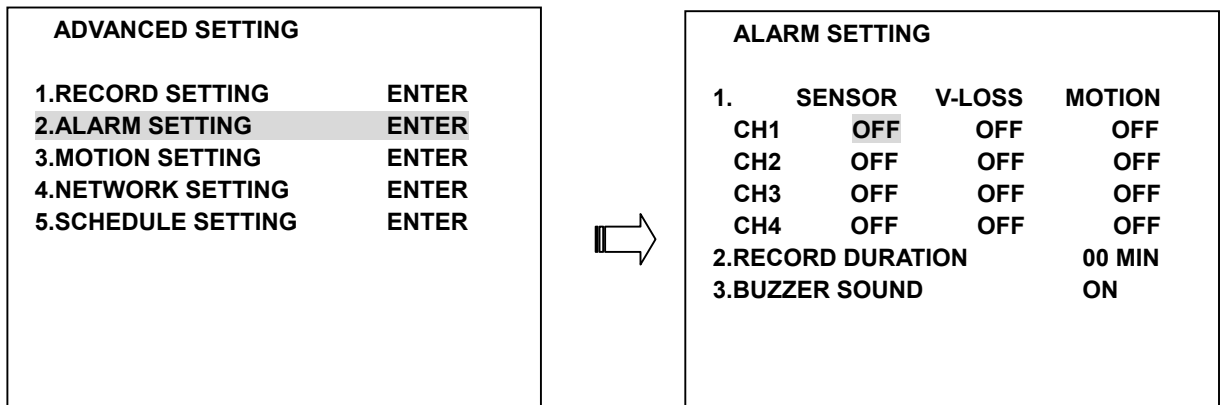

#### 1. ALARM INPUT:

Select and set each channel to activate ( **ON** ) or deactivate ( **OFF** ) the three modes of "SENSOR", "V ( VIDEO )-LOSS", and "MOTION".

**SENSOR:** An alarm is triggered when the sensor is touched.

**V-LOSS:** An alarm occurs when video is lost.

**MOTION:** Alarms which are activated while the motion detection function is operating.

#### 2. ALARM DURATION:

Choose a particular duration period to set off an alarm. The duration time ranges from **0** second, **30** seconds, **1** minute, **5** minutes to **10** minutes or **NONSTOP**.

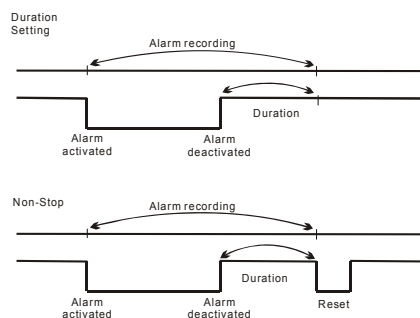

#### 3. BUZZER SOUND:

When an alarm is triggered the device will start beeping.

**ON:** Enables the function.

**OFF:** Disables the function.

### 5.5.3 MOTION SETTING

Here you can set the motion detection area of each channel.

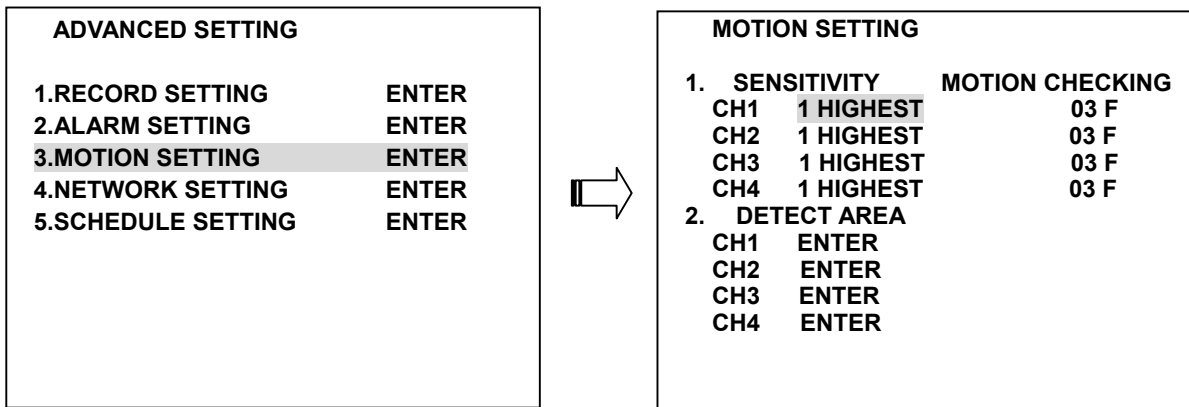

#### 1. SENSITIVITY:

Control the sensitivity of the motion detection function. Use the “^” and “v” buttons to select the sensitivity from “1 HIGHEST”, “2 HIGH”, “3 NORMAL”, “4 LOW” to “5 LOWEST” for each channel.

#### MOTION CHECKING:

The alarm input in each channel can be set from 0 to 15 images. Once motion detection occurs the numbers of images you set, the device will emit an alarm.

#### 2. DETECT ZONE:

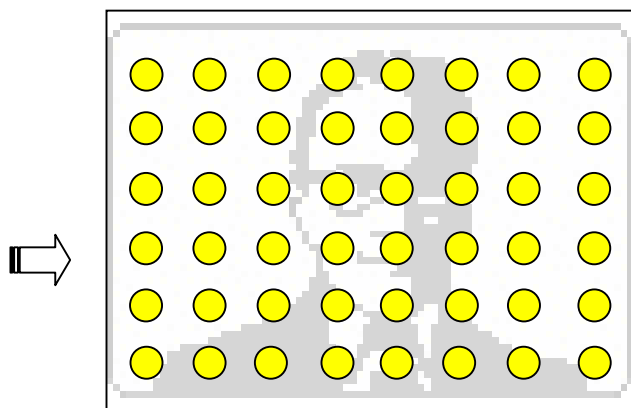
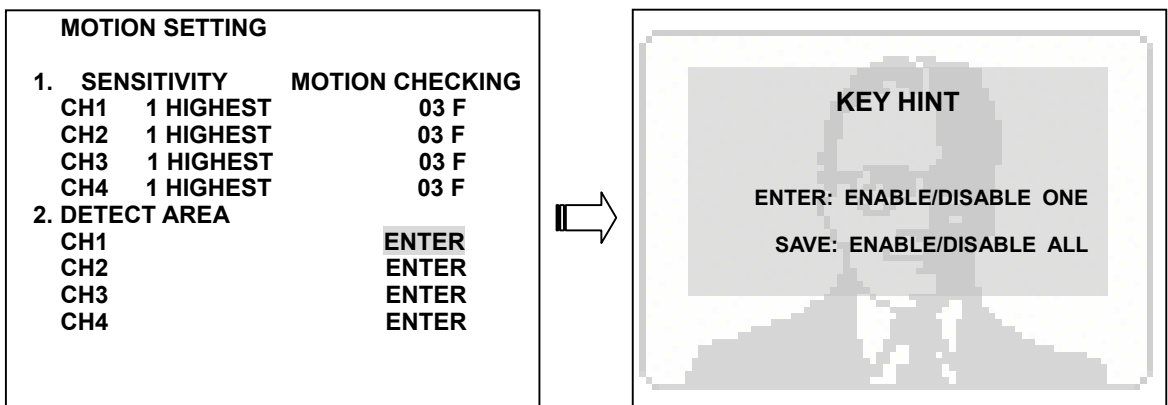

The user needs to see the situation in each channel in order to set a detection zone within the 8W x6H (48) area. The effective points are marked “●” (red) and the ineffective points are marked “●” (yellow).

The user can use the manual mode to set the target area. Please press the “^”, “v”, “<” or “>” buttons to select the points, and use the **Enter** button to mark them one by one; or press the **Save** button to activate the whole points.

#### 5.5.4 NETWORK SETTING

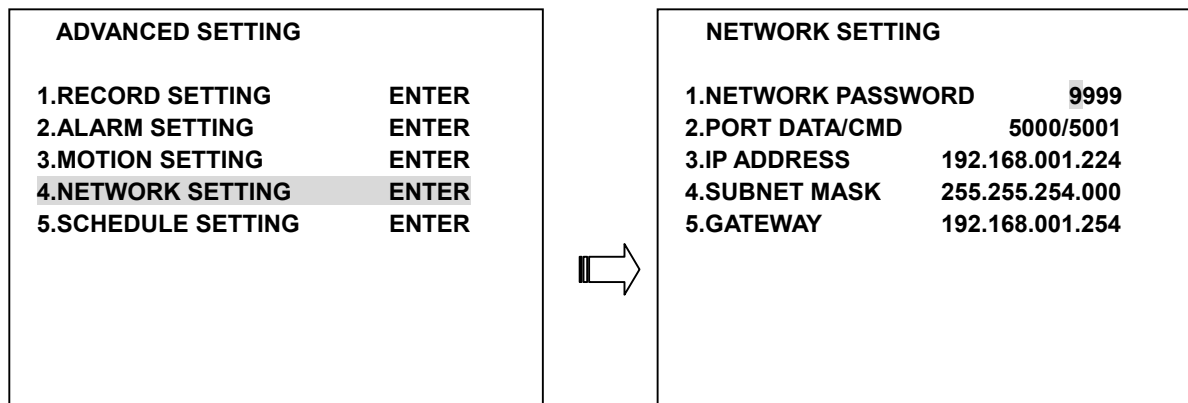

**1. NETWORK PASSWORD:** The default admin password is **9999**.

**2. PORT DATA/CMD:** The option is to set the transfer ports of the image data and command data.

**Note:** The values of DATA/CMD ports must be the same with the setting of the Network Viewer software (refer to chapter 7).

**3. IP ADDRESS:** The IP address may be manually edited.

**4. SUBNET MASK:** The IP mask may be manually edited.

**5. GATEWAY:** The gateway may be manually edited.

**NOTE:** When only one unit of the DVR is connected to a computer or LAN, you can freely assign an IP address for the DVR. For example, there is a range of DVR IP addresses from 192.168.1.1 to 192.168.1.255. You can pick one for use from the range of the IPs. It's not necessary to set MASK and GATEWAY; leave the settings as default.

When a DVR is connected to a WAN, you must acquire a unique, permanent IP address and correctly configure the MASK and GATEWAY settings according to your network architecture. If you have any questions regarding these settings, please contact a qualified MIS professional or your ISP.

**NOTE:** When connecting to a network, each connected DVR must be assigned a unique IP, which must be in the same class type as your network address. IP addresses are written as four sets of numbers separated by periods; for example, 192.168.1.1 Therefore, if the connected network is identified as Class C, for example, the first three sets of numbers of the DVR IP address must be the same as in the network address. If the connected network is identified as Class B, the first two sets of numbers of the DVR IP address must be the same as in the network address. If you have any questions regarding these settings, please contact a qualified MIS professional or your ISP.

### 5.5.5 SCHEDULE SETTING

Enter the setting to set up 7 forms of schedules. Use the **▲** or **▼** button to choose **ON** (ENABLE) or **OFF** (DISABLE) for each schedule.

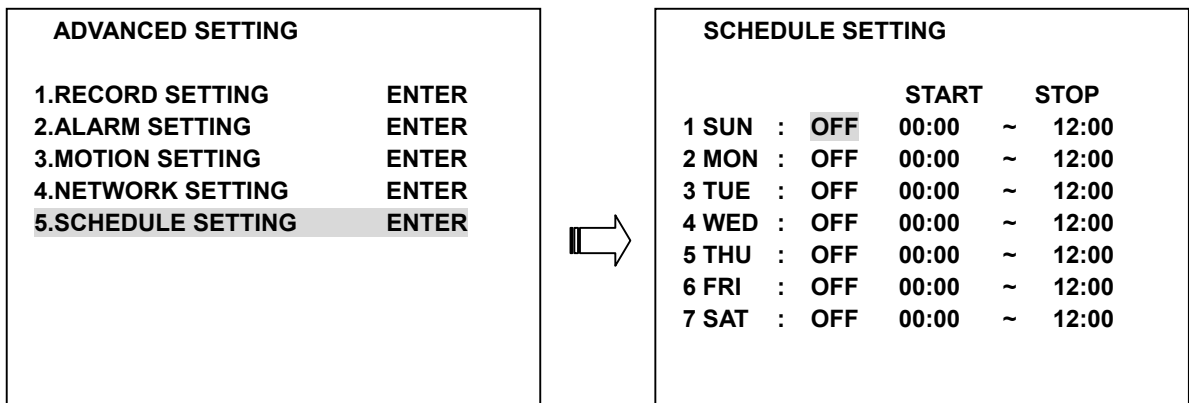

**1. DATE:** You can choose a single day or several days in a week.

**2. START TIME:** The time a schedule commences.

**3. STOP TIME:** The concluding time of a schedule.

## 5.6 DISK SETUP

Enter the disk setup mode to select your desired setting.

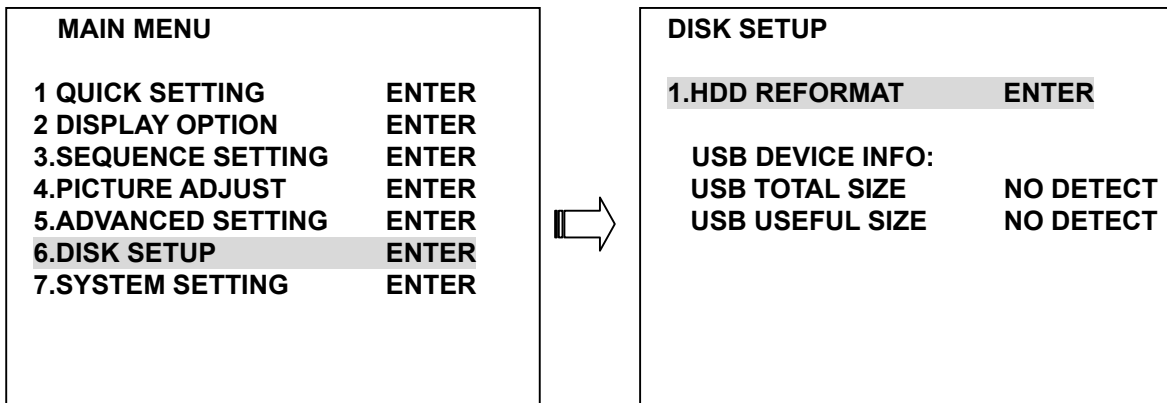

### 1. HDD REFORMAT:

This option allows you to clear out all the data in the HDD. After entering the item, a message of “**FORMAT HDD?**” will appear. If you want to format the HDD, please select “**YES**”, then press the **Enter** button.

### 2. USB DEVICE INFO:

The DVR can be connected to a USB flash memory.

**USB TOTLE SIZE:** You can find the USB device capacity here if the DVR connected with the USB device.

**USB USEFUL SIZE:** You can find the useful size of the USB device here if the DVR is connected with the USB device.

## 5.7 SYSTEM SETTING

Enter the system setting mode to select your desired setting.

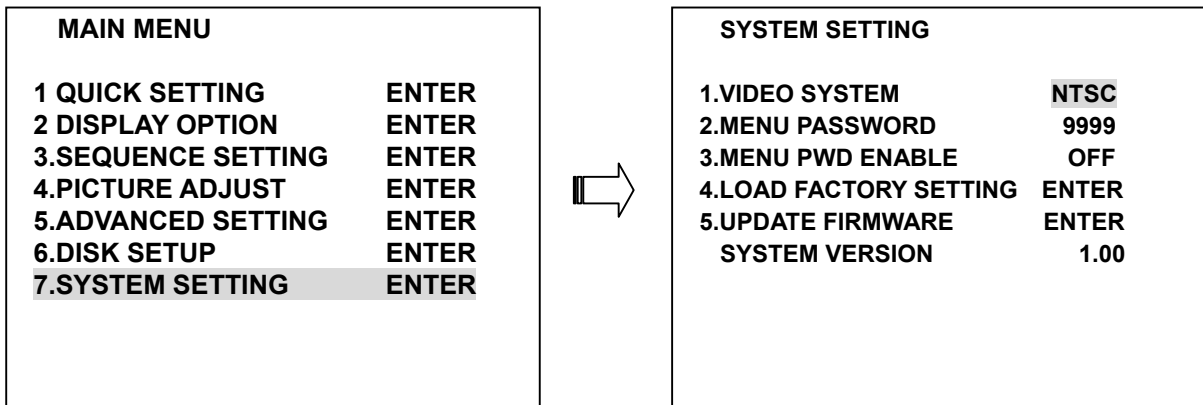

### 1. VIDEO SYSTEM:

Select the NTSC or PAL formats. In the NTSC system, the time display type is MM/DD/YYYY. If the user selects the PAL system, the type will change to DD/MM/YYYY automatically.

### 2. MENU PASSWORD:

This option lets you set a password to block any unauthorized entry. The default password is **9999**. Use the “^” or “v” button to set a 4-digit password of your choice.

### 3. MENU PWD ENABLE:

Activate to **ON** ( enable ) or **OFF** ( disable ).

After setting the password and enabling this function, when you enter the **MAIN MENU** the next time, a message of “**CHECK MENU PASSWORD**” will appear. Please enter the correct password, then press the **Enter** button to enter the **MAIN MENU**.

### 4. LOAD FACTORY SETTING:

If you want to execute the default setting, shift the focus to this item and enter. After entering the item, a message of “**LOAD FACTORY SETTING**” will appear. If you want to load the factory setting, please select “**YES**”, then press the **Enter** button.

### 5. UPDATE FIRMWARE:

If the system software of the DVR needs to be upgraded, please take the following steps to safely update it.

- (1) Copy the file of **update.bin** into your USB device.
- (2) Please highlight **UPDATE FIRMWARE**, then press the **Enter** button.
- (3) After entering the item, a message of “**UPDATE FIRMWARE?**” will appear.
- (4) If you want to update the system software, please select “**YES**”, then press the **Enter** button.
- (5) When a message of **PROGRAM FLASH: SUCCESS PRESS POWER KEY TO RESTART** appears, please press the power button to restart the device.

**NOTE: Before carrying out the following procedures, please ensure the USB device is working and the system software file is intact.**

### 6. SYSTEM VERSION:

You can find the software version here.

## 6. DISPLAY MODE

You can display the HDD information as shown on **Figure 6A** below at any time by pressing the **Display** button. The unit displays status on a monitor as shown next.

**Figure 6A**

08/23/2006 10:05:24			
	HDD1	HDD2	
HDD MODEL	ST340015A		
HDD SIZE	40G		
HDD USED	61%		
HDD READ	00%	NO DETECT	
HDD STATUS	REC		
REC LIST	005		
ALM LIST	0000		
HDD REST/TOTAL TIME	14/	24 hr	
USB REST/TOTAL SIZE	620/	978 MB	

**HDD MODEL:** Shows the models of HDD.

**HDD SIZE:** The capacity of the installed hard disks.

**HDD USED:** Percentages of system recording.

**HDD READ:** Percentages of the recorded file for reading.

**HDD STATUS:** Indicates the device status.

- **REC:** The device is in the recording mode.
- **PLAY:** The device is in the playback mode.
- **REC+PLAY:** The device is in the recording and playback mode.

**REC LIST:** The numbers of the recording lists.

**ALM LIST:** The numbers of the alarm-recording lists.

**HDD REST/TOTAL TIME:**

Total 14 hours remaining time available.

Total 24 hours recording time available.

**USB REST/TOTAL TIME:**

Total 620 MB rest capacity of memory available.

Total 978 MB memory capacity available.

Press the **Display** button again; the unit will display the information as shown in **Figure 6B** below.

**Figure 6B**

08/23/2006 10:05:26			
RECORD MODE		STOP	
RECORD RATE		60 F/S	
RECORD QUALITY		STANDARD	
RESOLUTION		720 X 240	
DISK FULL		STOP	
MAC ADDRESS :	0A:0B:0C:0D:0E:0E		
IP ADDRESS :	192.168.001.224		
SUBNET MASK :	255.255.254.000		
GATEWAY :	192.168.001.254		

**RECORD MODE:** Shows the mode of recording.

**STOP; MANUAL; TIMER; ALARM.**

**RECORD RATE:** Shows the rate of recording.

**RECORD QUALITY:** Shows the quality of recording.

**RESOLUTION:** Shows the resolution of recording.

**DISK FULL:** Shows the way to utilize storage media in case of a full disk.

**MAC ADDRESS:** Network MAC address.

**IP ADDRESS:** Network IP address.

**SUBNET MASK:** Network mask.

**GATEWAY:** Network gateway.

Press **any button** (except the **^**, **v**, **<**, **>** buttons) to escape the Display mode.

## **7. NETWORK VIEWER: INTRODUCTION**

Please use our Network Viewer to connect the DVR. It supports your local PC simultaneously with the DVR backup data. See below for the chief features of this Network Viewer.

The programs can be operated by a selected PC equipped with the following requirements :

1. Intel Pentium III 750MHz (at least).
2. 128 MB RAM
3. Windows 2000, XP or above.
4. 4 MB Video card capable of 24-bit true color display.
5. 160 MB free hard-disk space for software installation.
6. 10-base T network for LAN operation.

### **7.1 TCP/IP COMMUNICATION SETUP**

Follow the instructions below to install the TCP/IP communication program into your computer.

1. Click the **Start** Menu from your computer, and point to the **Control panel**.



2. Double click the **Network Connections** icon to enter the Network setting windows.

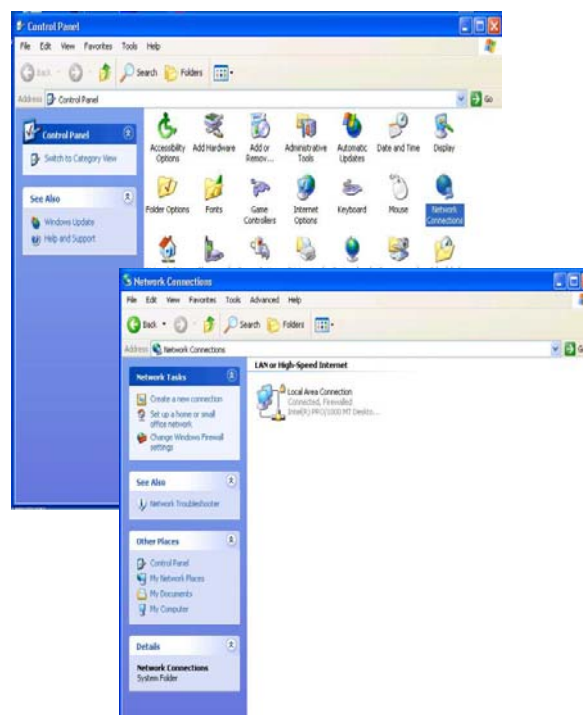



Point to the **Local Area Connection** and press the right mouse button. Click **Properties** to enter the **Local Area Connection**.

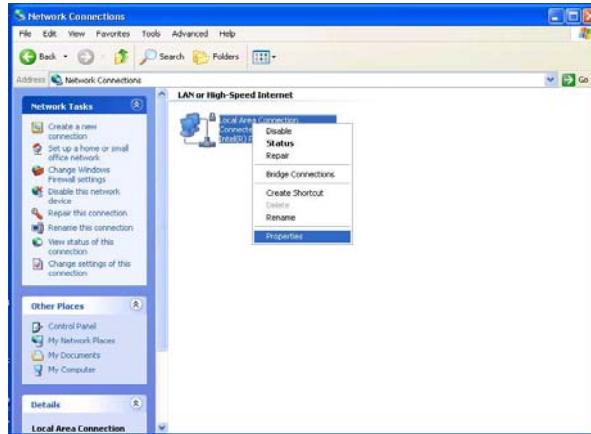

3. Click the **Configuration** tag; check if the TCP/IP is included in the network components list. If the TCP/IP is included, please process step 5. If it is not included, please follow step 4 to install the TCP/IP.

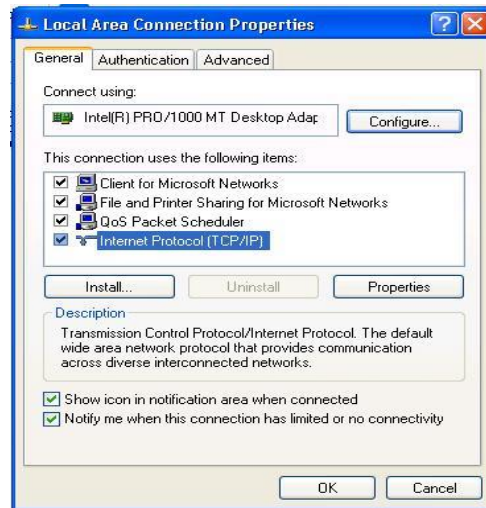

#### 4. TCP/IP installation.

During the installation, you will be requested to insert the windows XP CD ROM. After installation, the PC will be restarted.

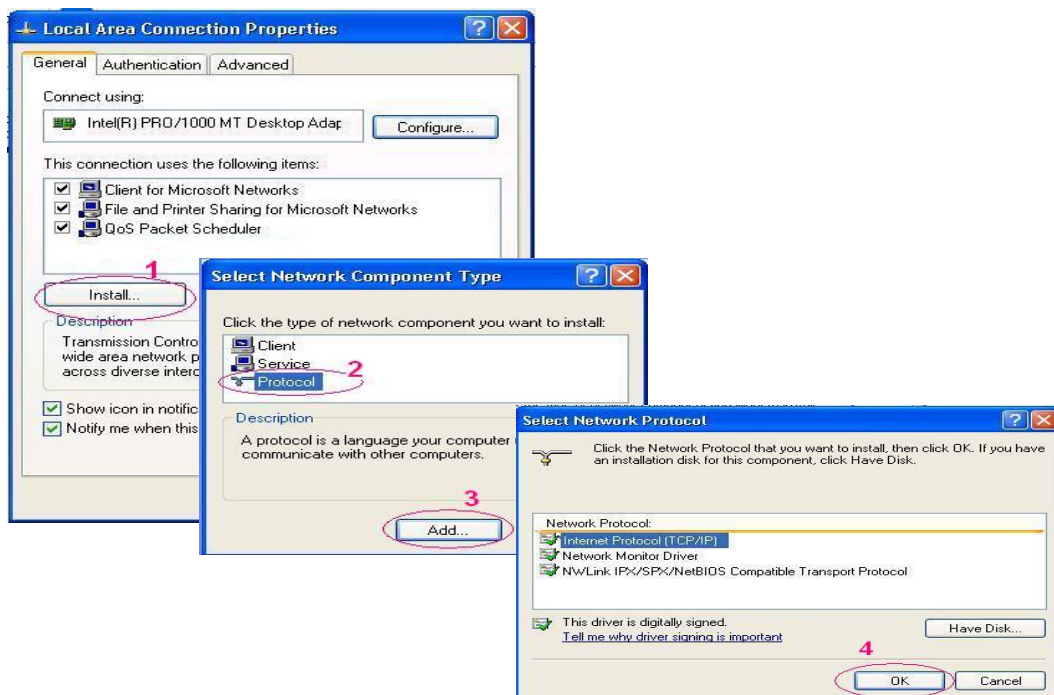

## 5. TCP/IP Configuration setting

- Click **Start → Control Panel → Network Connections → Local Area Connection**
- Select **Internet Protocol (TCP/IP)**, and then click **Properties**.
- Before processing the DVR installation in a WAN, please make sure the Internet connection works properly. If not, please contact your ISP provider.

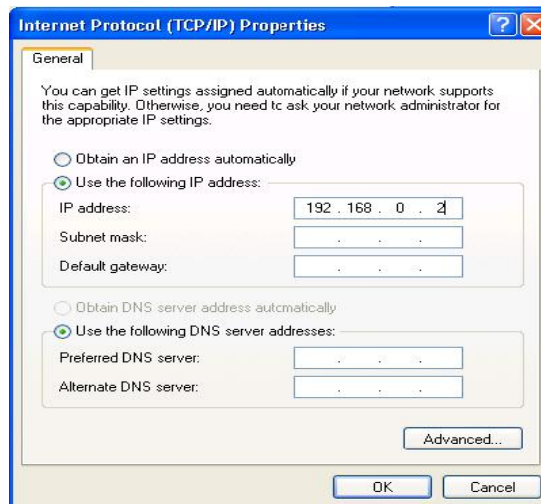
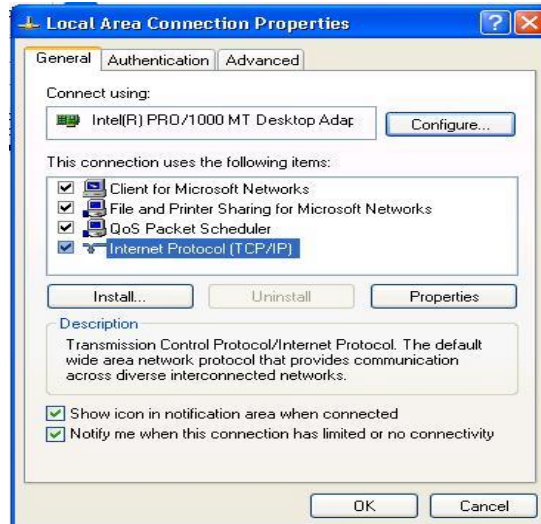

If you are using a DHCP server, please select "Obtain an IP address automatically". Any assigned IP address for the connected DVRs must be in the same class type as the server. If there is no DHCP server, please select a specific IP address and type in the IP address of your PC. This IP address must be different from the DVR IP but in the same class type.

**Note: The IP address of a DVR in a network must be unique to itself as opposed to those of the other chosen PCs, but in the same class type.**

## 7.2 CONNECTION TESTING

As with the previous settings, follow the instructions below to ensure you have established the connection successfully.

1. Click **Start → Command Programs**



2. Type in **ping 192.168.1.1**, then Enter. (See the sample screen below.)

\*\* This IP is the DVR IP address that is assigned for the connected DVR.

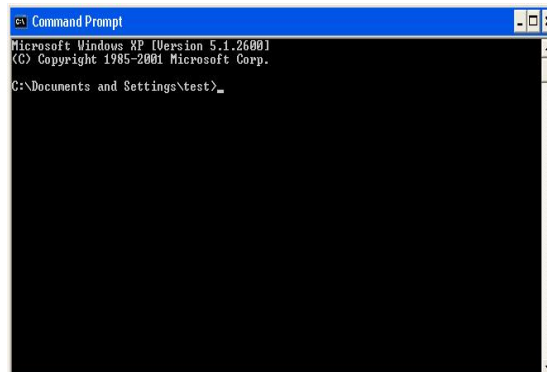

3. If you receive a response as in the sample screen below, the connection hasn't been successfully established. Please re-check all the hardware and software installations by repeating steps 1 to 5. If you still can't establish the connection after rechecking, please contact your dealer.

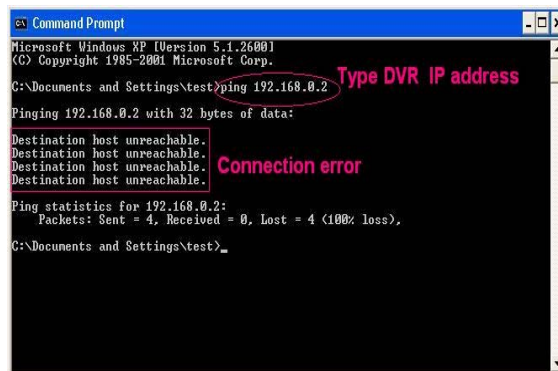

4. If you receive a response as in the sample screen below, you have successfully made the connection.

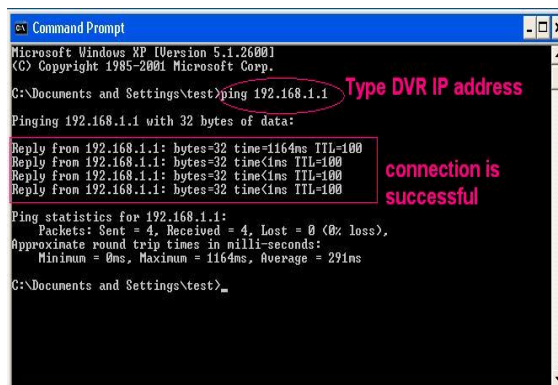

## 7.3 SOFTWARE INSTALLATION

**Step 1:** Exit all applications currently running in the selected PC.

**Step 2:** Insert the supported PC in the CD-ROM device. It'll automatically enter the "**Network Viewer**" installation screen. Please see the screen below.

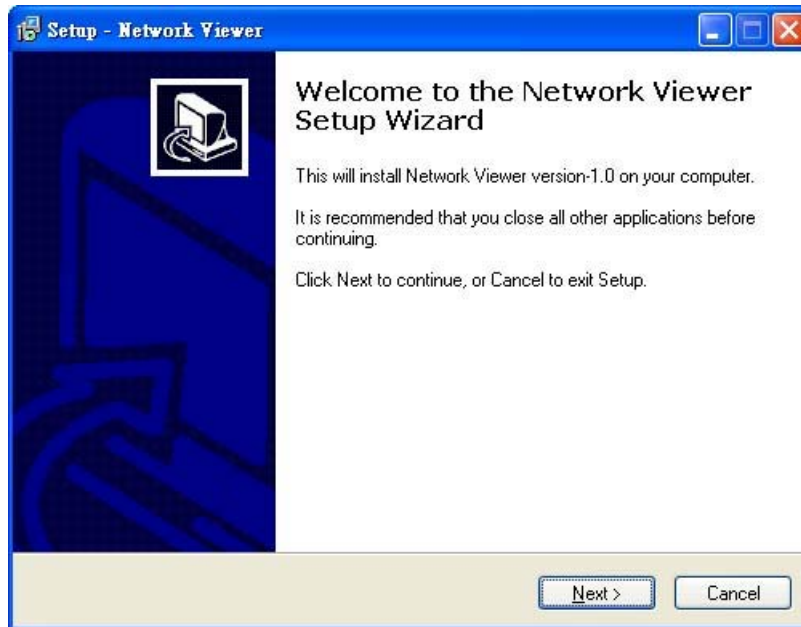

**Note:** Please choose the "**Next**" button to continue.

**Step 3:** The installation screen will show the message "**C :\ Program Files \ Network Viewer\**" Or you can select the path you want.

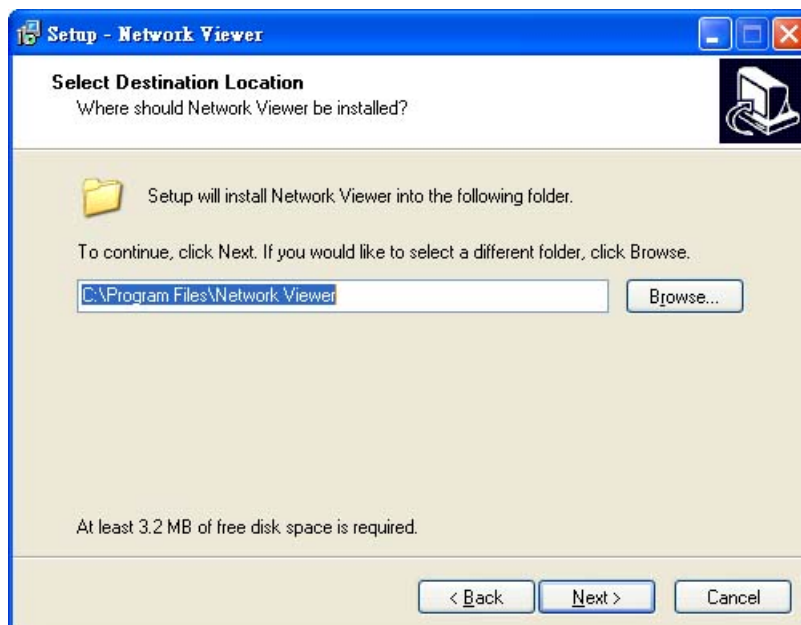

**Note:** Click "**Next**" to continue the installation.

**Step 4:** The installation screen will show the message **"Network viewer"**. Or you can enter the folder name you want.

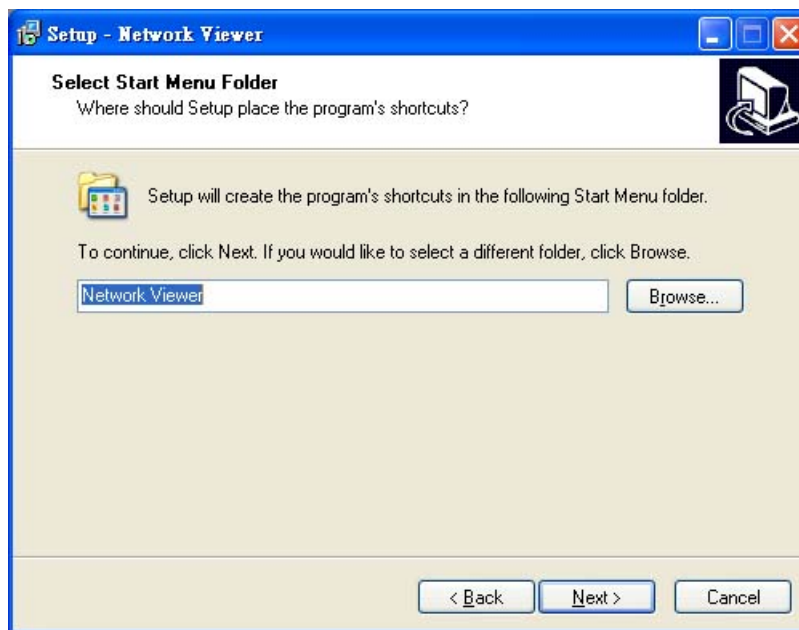

**Note:** Click **"Next"** to continue the installation.

**Step 5:** Tick to create a desktop icon.

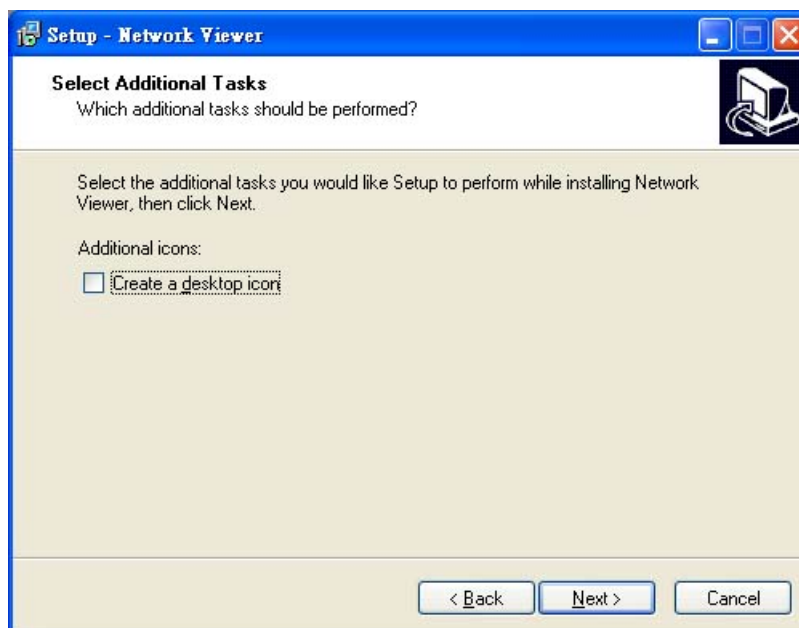

**Note:** Click **"Next"** to continue the installation.

**Step 6:** Confirm the installation details.

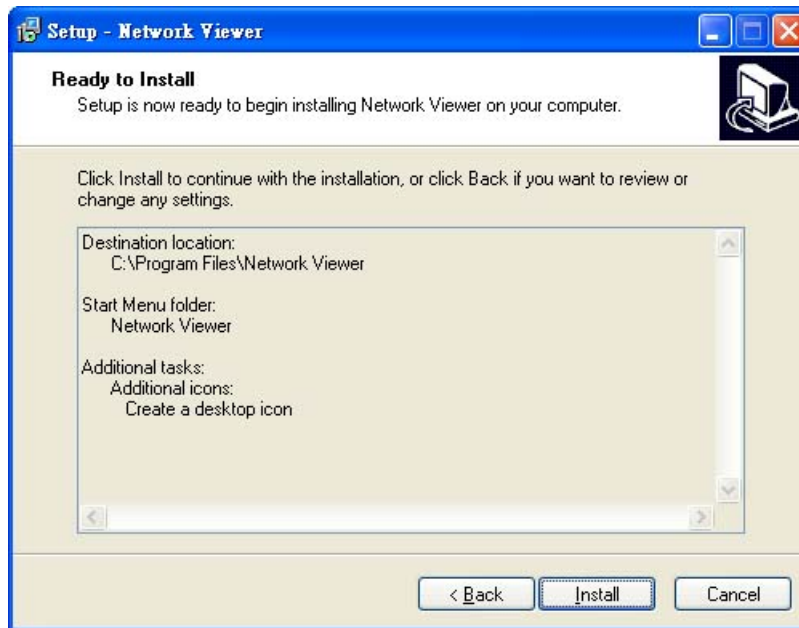

**Note:** Click **"Install"** to continue the installation.

**Step 7:** The window below tells you the process is complete.

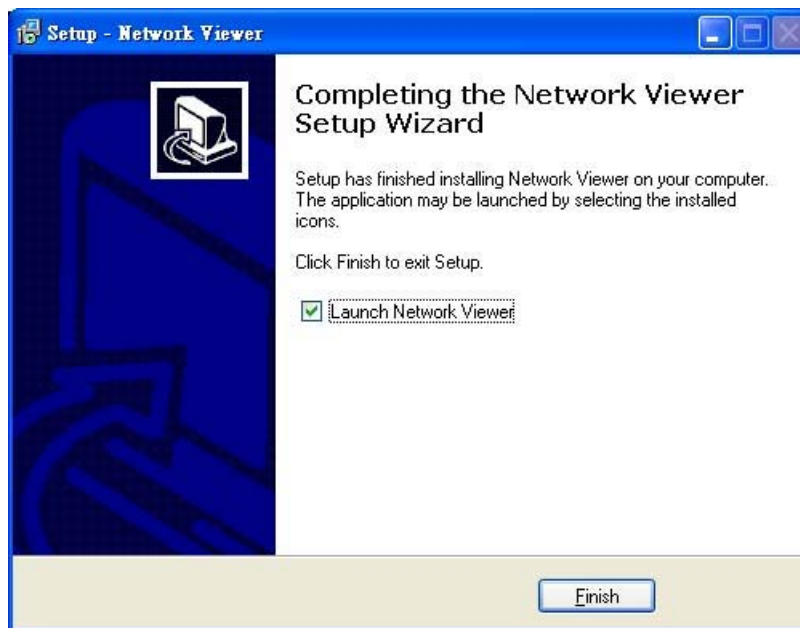

**Note:** Click the **"Finish"** button to complete the installation process.

**Step 8:** After completing installation, you can double-click the file shown below. Or click the **"Start Menu"** in the computer and select **"Programs"** to open the **"Network Viewer"** page. Then click the **"Network Viewer"** tag to start the program.



**Note:** Please make sure the TCP/IP communication software has been properly set and configured in your computer.

## 7.4 VIEW THE DVR VIDEO FROM A REMOTE PC

Follow the instructions below to use the **Network Viewer** software to browse the DVR-3074 video from a remote location.

**Note:** Every DVR provides only **one** user to login at one time.

Upon entering the **Network Viewer**, a connection box will appear as follows. The default multi-screen is the 16-channel mode.

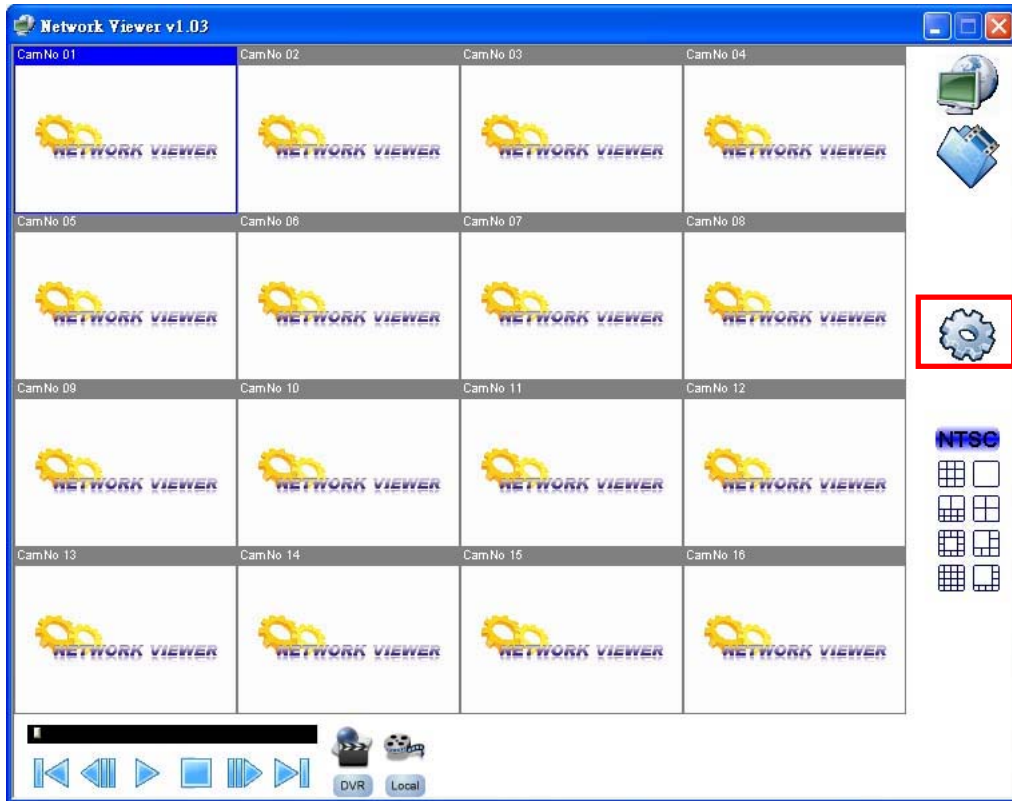

**Step 1:** Press the  button to enter the **Network Viewer Setting** window which is shown below.

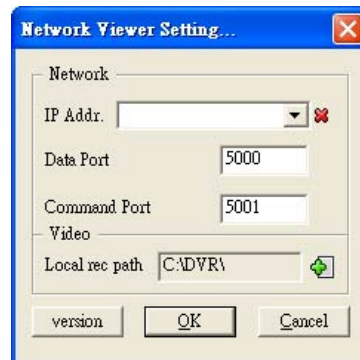

**Step 2:** Please enter your DVR's IP Address and key in the correct Data/Command port values.

**Note:** Please make sure the values of Data and Command ports which you enter are the same as given in with the **NETWORK SETTING** page of the DVR.

**Step 3:** Press the **OK** button.



**Step 4:** Press the button to enter the **Network Viewer Setting** window which is shown below.

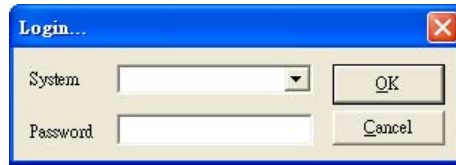

**Step 5:** Please type or select the IP address which is set in **Step 2** from the drop-down list. Enter the password (the default is "9999"), then click the **OK** button.

**Step 6:** After entering the DVR, you will see the videos of all the cameras as shown below.







**Note:** To add more connections of other DVRs, please repeat the above instructions.



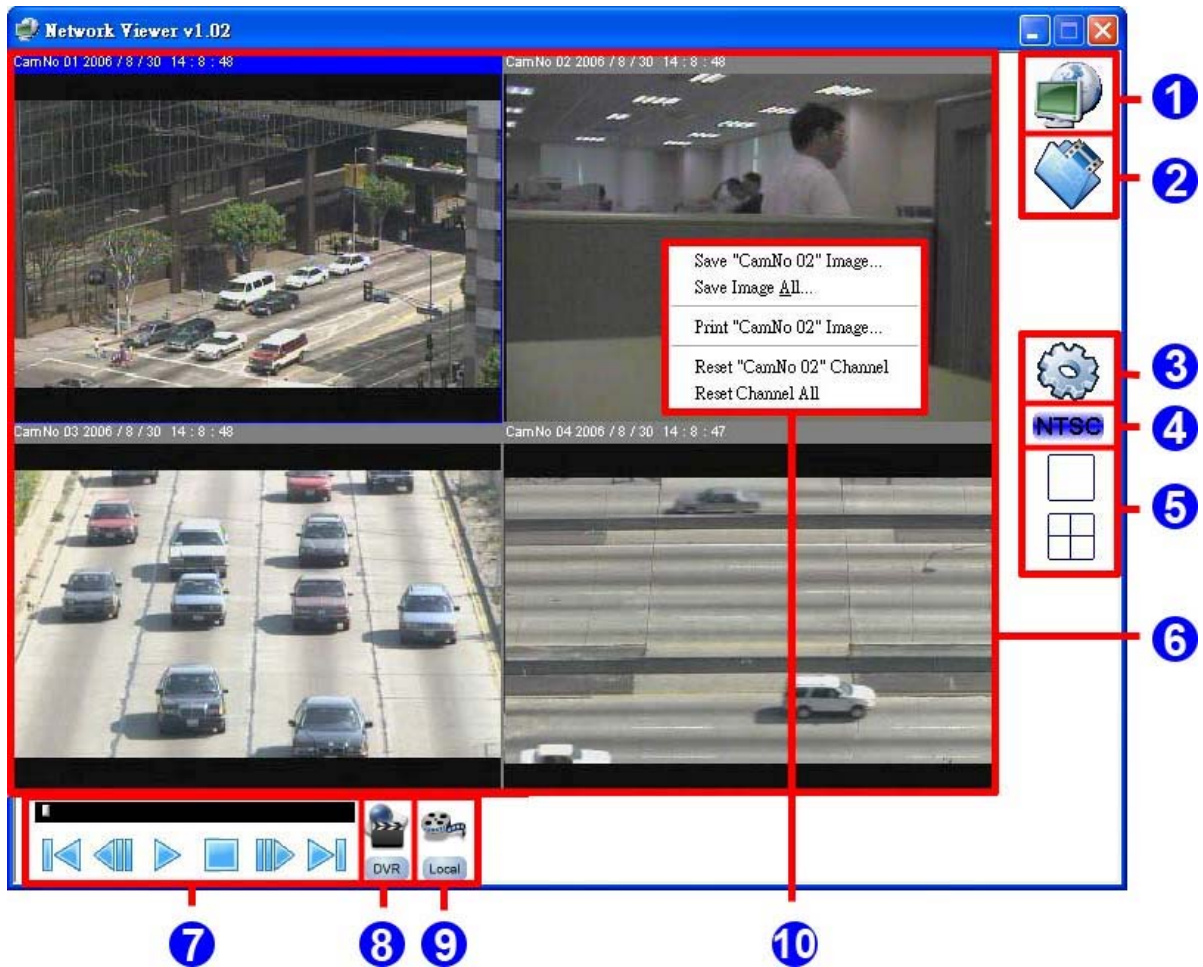



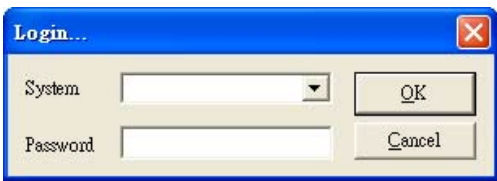





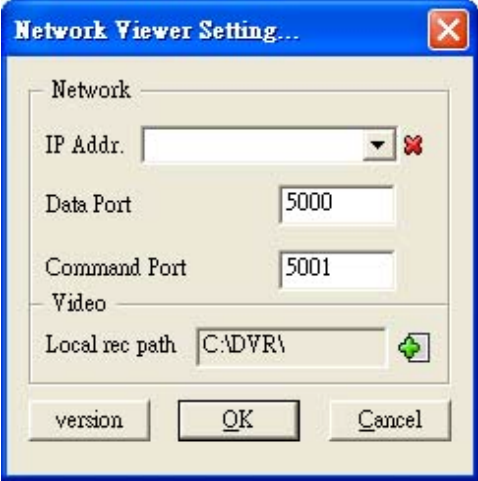

**Note:** It's necessary to remove the exit program when you are going to install a new version of Network Viewer. Every time you update the Network Viewer, the original version must be removed first.



## 7.5 OPERATION



<p><b>Connect to a DVR:</b> Press the  button to enter the</p> <p><b>1. Network Viewer Setting</b> window. Select the IP address from the drop-down list which you want to connect, type the correct password, and then press the OK button to connect.</p>	
<p><b>2. Open the local files:</b> Press the  button to open the recorded files in the disks.</p> <p><b>Note:</b> Select the recorded file (*.dvr), and then press the  button to play it.</p>	

<p><b>Set the working environment:</b></p> <p>(1) Type a new IP address. The Network Viewer can memorize <b>25</b> IP addresses of DVRs. Press the  button to delete the IP information.</p> <p>(2) Enter the values of the ports.</p> <p>3. Please make sure the values of Data and Command ports which you enter are the same as given in the <b>NETWORK SETTING</b> page of the DVR.</p> <p>(3) Select the recoding path you want for backup file. Press the  button to select the recording path.</p> <p><b>Note:</b> To add more connections of other DVRs, please repeat the above instructions.</p>	 <p>The dialog box is titled "Network Viewer Setting...". It contains fields for "Network" (a dropdown menu), "IP Addr." (a text box with a red X icon to its right), "Data Port" (a text box with "5000" entered), "Command Port" (a text box with "5001" entered), "Video" (a section header), and "Local rec path" (a text box with "C:\DVR\" entered and a green folder icon to its right). At the bottom, there are buttons for "version", "OK", and "Cancel".</p>
<p>4. <b>Convert the NTSC/PAL display mode:</b> Press the  button to convert to the NTSC mode; press the  button to convert to the PAL mode.</p> <p><b>Note:</b> This function only effects in the playing back mode.</p>	
<p>5. <b>Screen divisions:</b> Choose any of the buttons you want.</p>	
<p>6. <b>Multi-screen:</b> The videos of all the cameras are displayed here.</p>	
<p>7. <b>Scroll bar and function keys:</b> Click each of these buttons to execute its functions.</p>	
<p>8. <b>DVR recording control:</b> Press the  button to start to record or to stop recording. While recording, the  icon will become yellow in color. In the non-recording mode, the  icon will return to the blue color.</p> <p><b>Note:</b> When the hard disk is full and the <b>DISK FULL</b> option is set to <b>STOP</b>, there will appear a warning message of "Can't get the recording status! Please re-connect and try again."</p>	<p><b>Click Yes to start recording:</b></p>  <p><b>Click Yes to stop recording:</b></p>  <p>The first dialog box is titled "DVR Record status" and contains the message "The DVR is not in the recording status now, do you want to start recording?" with "Yes" and "No" buttons. The second dialog box is also titled "DVR Record status" and contains the message "The DVR is in the recording status now, do you want to stop recording?" with "Yes" and "No" buttons.</p>
<p>9. <b>Save video stream:</b> Press the  button to start to save the "Live" images into a video stream (*.dvr). While saving, the  icon will become yellow in color. Press the  button one more time to stop saving, and the  icon will become blue.</p>	

**Pop-menu:** You can use the mouse to move to each channel. Click the right key of the mouse to show a window. You can select **Save "CamNo XX" Image**, **"Save All"**, **Print "CamNo XX" Image**, **Reset "CamNo XX" Channel** or **"Reset All"**.

- **Save single-channel image:** Click to save a JPG image of the chosen channel. You can set the backup file path and the file name.
- 10. ● **Save all images:** Click to save four JPG images of 4 channels. You can set the backup file path and the file name.
- **Print single-channel image:** Click the **Print "CamNo XX" Image** button to enter the **"Print image"** page. Click **"Print"** to start the printing. Click **"Close"** to cancel.
- **Reset single channel:** Reload the signal of the channel.
- **Reset all channel:** Reload the signal of all channels.

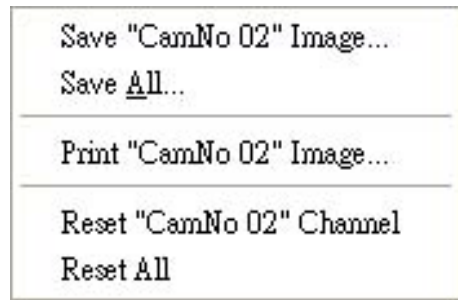

## 8. SPECIFICATIONS

Model	DVR-3704T	
Image System	NTSC	PAL
Video Resolution	720x240 pixels 360x240 pixels	720x288 pixels 360x288 pixels
Operation Mode	Triplex (Simultaneous Live, Play, Record and Network)	
Video Input	BNC x 4 (termination: DIP SW)	
Video Output	Main (BNC), Looping(BNC) x 4	
Audio In/Out	Audio Input x 1 (RCA) / Audio Output x 1 (RCA)	
Compression	MJPEG	
Storage Media	>750Gb / 1 Fixed HDD	
Archive	USB Disk	
Watermark	Embedded Digital Signature	
Recording Rate	Max. 60 Field/sec (720X240 pixels) Fixed in 120 Field/sec (360X240 pixels)	Max. 50 Field/sec (720X288 pixels) Fixed in 100 Field/sec (360X288 pixels)
Image Size	Best (48KB)/ High (34KB)/ Standard (17KB)/ Basic (10KB)	
Recording Mode	Manual/ Alarm/ Circular/ Timer	
Alarm Recording	Pre-Alarm/ Post-Alarm	
Pre-alarm Recording	30 images	
Playback Speeds	Fast Forward: 2X, 4X, 8X, 16X Reverse: 1X, 2X, 4X, 8X, 16X Image Stepping	
Search	Time Filter, Alarm List, Record List	
Zoom	2X Digital Zoom	
Motion Detection	5 level sensitivity control, 8 x 6 motion area set-up	
OSD	Cam Title/ Time & Date/ Mode/ Error Message	
Alarm In/Out	4 Alarm Inputs/ 1 Alarm Outputs	
Built-in Buzzer	Yes	
Camera title	8 char.	
Communication Port	RS-232, and Ethernet Ports	
Network Interface	Ethernet (RJ-45 10/100 base-Tx)	
Network Protocol	TCP/IP	
Network Capabilities	Archive image as JPEG formats Remote live or recorded images	
USB	Firmware Update, Image Backup	
Password Protection	Yes	
Power input	Input: 100-230V, 50/60 Hz; Output: DC12V max 5A: (AC Adapter)	
Operating Temperature	5 - 40 °C (41 -104 °F)	
Regulation	FCC, CE	

**\*\*Design and specifications are subject to change without notice.**

## **APPENDIX 1. – Insert the mobile rack**

To add the second hard disk into the DVR, the user has to insert the mobile rack first.

To install the mobile rack, please take the following steps:

**Step 1:** Loosen the mounting screw “①” in the mobile rack “ I “ of the DVR and detach it.

**Step 2:** Draw out the mobile rack “ I “ from the DVR.

**Step 3:** Insert the mobile rack “ II “ in the device and screw in screw “②”.

**Step 4:** Insert the mobile rack “ I “ back in the device and screw in screw “①”.

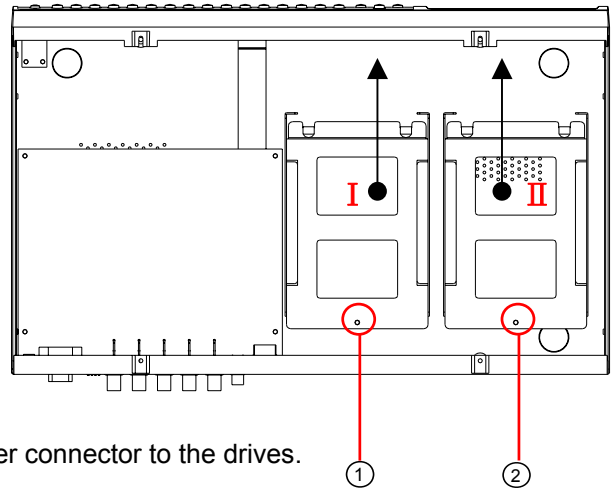

**Note:** Please attach the interface connector and the power connector to the drives.

**The installation of the mobile rack is complete:**

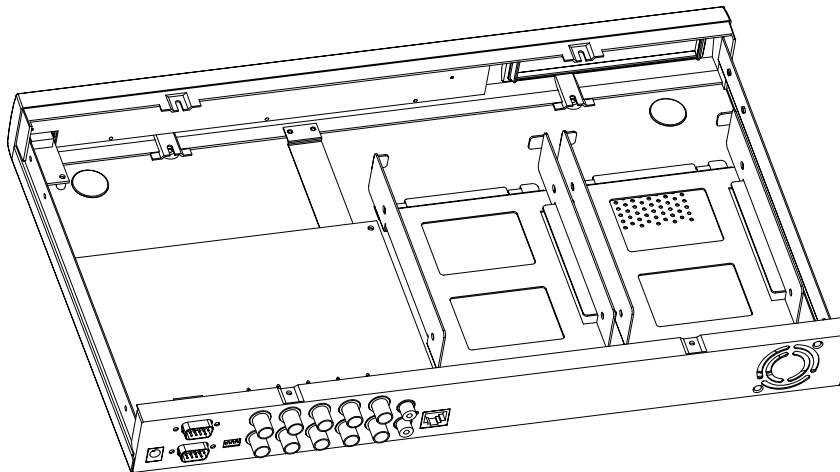

※ **The mobile rack is a purchase option.**

## APPENDIX 2. – RS-232 Connection

### CONNECTION

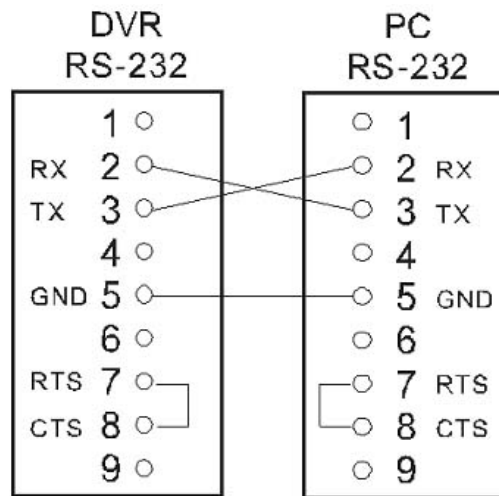

The transmission protocol is 8 data bit: 1 start bit, 1 stop bit and no parity. Five different speeds can be used: 1200 baud per second, 2400 baud, 4800 baud, 9600 baud and 19200 baud. The default setting is 2400 baud per second.

## APPENDIX 3. – Compatible SATA hard-disk drives

The compatible hard-disk drives, which can be used with the unit, are shown in the tables below.

Manufacturer	Model	Capacity	Rotation	Cache
Seagate	ST340215AS	40G	7200 RPM	2M
	ST340815AS	40G	7200 RPM	8M
	ST380215AS	80G	7200 RPM	2M
	ST380815AS	80G	7200 RPM	8M
	ST3120215AS	120G	7200 RPM	2M
	ST3120815AS	120G	7200 RPM	8M
	ST3160215AS	160G	7200 RPM	2M
	ST3160815AS	160G	7200 RPM	8M
	ST3200820AS	200G	7200 RPM	8M
	ST3250820AS	250G	7200 RPM	8M
	ST3250620AS	250G	7200 RPM	16M
	ST3300820AS	300G	7200 RPM	8M
	ST3300620AS	300G	7200 RPM	16M
	ST3320820AS	320G	7200 RPM	8M
	ST3320620AS	320G	7200 RPM	16M
	ST3400820AS	400G	7200 RPM	8M
	ST3400620AS	400G	7200 RPM	16M
	ST3500830AS	500G	7200 RPM	8M
	ST3500630AS	500G	7200 RPM	16M
	ST3750840AS	750G	7200 RPM	8M
	ST3750640AS	750G	7200 RPM	16M
	ST3160815SV	160G	7200 RPM	8M
	ST3250820SV	250G	7200 RPM	8M
	ST3320620SV	320G	7200 RPM	16M
	ST3500630SV	500G	7200 RPM	16M
	ST3750640SV	750G	7200 RPM	16M
	ST3250820NS	250G	7200 RPM	8M
	ST3250620NS	250G	7200 RPM	16M
	ST3320620NS	320G	7200 RPM	16M
	ST3400620NS	400G	7200 RPM	16M
ST3500630NS	500G	7200 RPM	16M	
ST3750640NS	750G	7200 RPM	16M	
Western Digital	WD800AABS	80G	7200 RPM	2M
	WD800AAJS	80G	7200 RPM	8M
	WD1200AABS	120G	7200 RPM	2M
	WD1200AAJS	120G	7200 RPM	8M
	WD1200AAKS	120G	7200 RPM	16M
	WD1600AABS	160G	7200 RPM	2M
	WD1600AAJS	160G	7200 RPM	8M
	WD1600AAKS	160G	7200 RPM	16M
	WD2500AABS	250G	7200 RPM	2M
	WD2500AAJS	250G	7200 RPM	8M
	WD2500AAKS	250G	7200 RPM	16M
	WD3200AABS	320G	7200 RPM	2M
	WD3200AAJS	320G	7200 RPM	8M
	WD3200AAKS	320G	7200 RPM	16M
	WD4000AAJS	400G	7200 RPM	8M
	WD4000AAKS	400G	7200 RPM	16M
	WD5000AAJS	500G	7200 RPM	8M
	WD5000AAKS	500G	7200 RPM	16M
	WD7500AAKS	750G	7200 RPM	16M
	WD7500AACs	750G	7200 RPM	16M
	WD10EACS	1T	7200 RPM	16M
	WD1600YS	160G	7200 RPM	16M
WD2500YS	250G	7200 RPM	16M	
WD3200YS	320G	7200 RPM	16M	
WD5000ABYS	500G	7200 RPM	16M	
WD5000AYYS	750G	7200 RPM	16M	

**NOTE:** Hard-disk drives not shown on this list have not been tested by our engineering team and are not recommended for use with this product. For the latest updated list on the recommended hard disk drives, please contact your dealers or distributors.

**CAUTION:** Please don't use the hard disk(s) you have employed with a particular model of the DVR (in recording and playing back data) with any other model of DVR, for you will lose the data you have stored in the hard disk(s) if you do so. You are free to use the same hard disks between DVRs belonging to a single model.

RMN0400280\_V1.0

## Free Manuals Download Website

<http://myh66.com>

<http://usermanuals.us>

<http://www.somanuals.com>

<http://www.4manuals.cc>

<http://www.manual-lib.com>

<http://www.404manual.com>

<http://www.luxmanual.com>

<http://aubethermostatmanual.com>

Golf course search by state

<http://golfingnear.com>

Email search by domain

<http://emailbydomain.com>

Auto manuals search

<http://auto.somanuals.com>

TV manuals search

<http://tv.somanuals.com>