


# INSTALLATION & OPERATING MANUAL

Network Video Recorder  
NVR-2018

  
**APPRO**<sup>®</sup>









Before trying to connect or operate this product, please read this manual completely



# SAFETY PRECAUTIONS



All the following safety and operated instructions which will prevent harm or damage to the operator and other persons should be read before the unit is operated.

## WARNING

-  To reduce the risk of fire or electric shock, do not expose this appliance to rain or moisture.
-  Do not block ventilation openings.
-  Do not place anything on top of the unit that might spill or fall into it.
-  Do not attempt to service this unit yourself as opening or removing covers may expose you to dangerous voltage or other hazards. Please refer all servicing to qualified service personnel.
-  Do not use liquid cleaners or aerosols for cleaning.
-  This installation should be by a qualified service person and should conform to all local codes.
-  To prevent fire or electric shock, do not overload wall outlets or extension cord.
-  This unit must be grounded to reduce the risk of electric shock hazard.

## CAUTION

### **Danger of explosion if the Lithium battery (RTC Battery) is incorrectly replaced.**

-  Danger of explosion if battery is incorrectly replaced. Replace only with the same or equivalent type recommended by the manufacturer. Dispose of used batteries according to the manufacturer's instructions.
-  Risk of explosion if replaced by an incorrect type. Dispose of used batteries according to the instructions.

## INFORMATION

This equipment has been tested and found to comply with the limits for a Class A digital device, pursuant to Part 15 of the FCC Rules. These limits are designed to provide reasonable protection against harmful interference when the equipment is operated in a commercial environment. This equipment generates, uses, and can radiate radio frequency energy and, if not installed and used in accordance with the instruction manual, may cause harmful interference to radio communications.

Operation of this equipment in a residential area is likely to cause harmful interference in which case the user will be required to correct the interference at his own expense.

# Table Of Contents

<b>1. PRODUCT FEATURES .....</b>	<b>4</b>
1.1 Product Introduction .....	4
1.2 Product Features .....	4
<b>2. DESCRIPTION OF THE FRONT/REAR VIEW.....</b>	<b>6</b>
2.1 Front View .....	6
2.2 Rear View .....	9
2.3 ALARM In/Out .....	10
<b>3. INSTALLATION .....</b>	<b>11</b>
3.1 Basic Connection .....	11
3.2 Hard-Disk Drive Installation .....	13
3.3 System Information .....	14
3.4 Updating System Software .....	15
<b>4. BASIC OPERATIONS .....</b>	<b>16</b>
4.1 Configuring Recording Settings .....	16
4.2 Recording Operations .....	17
4.3 Playback Operations .....	24
4.4 Search Operations .....	26
4.5 Backup Operations .....	29
4.6 Key Lock Operation .....	32
<b>5. MENU SETUP .....</b>	<b>33</b>
5.1 LAN CAMERA SETTING .....	34
5.2 REC SETTING .....	39
5.3 CLOCK / TIMER / SEQ SETTING .....	41
5.4 ALARM SETTING .....	42
5.5 COMMUNICATION .....	44
5.6 DISK SETTING .....	46
5.7 SYSTEM SETTING .....	47

<b>6. RS-232 PROTOCOL .....</b>	<b>50</b>
6.1 Setup.....	50
6.2 Communication Protocol .....	50
<b>7. IDE HARD DISK INSTALLATION .....</b>	<b>53</b>
7.1 Built-in hard disk.....	53
7.2 Mobile Rack .....	54
<b>8. O.S.D MESSAGE .....</b>	<b>57</b>
<b>9. NETWORK VIEWER AND IMAGE VIEWER.....</b>	<b>58</b>
9.1 The Network Viewer .....	58
9.2 The Image Viewer.....	67
<b>10. INDEX TABLE .....</b>	<b>68</b>
<b>11. NETWORK CONFIGURATION.....</b>	<b>69</b>
11.1 Cable Connections .....	69
11.2 Configure Your NVR Network Settings.....	70
11.3 TCP/IP Communication Software .....	72
11.4 TCP/IP installation.....	73
11.5 TCP/IP Configuration setting.....	74
11.6 Connection Testing.....	74
<b>12. MICROSOFT INTERNET EXPLORER.....</b>	<b>76</b>
12.1 Connecting the NVR-2018 .....	76
12.2 Change LANCAM SETUP Setting .....	79
12.3 Change Record / Alarm Setting.....	80
12.4 Change Timer Record Setting .....	81
<b>13. SPECIFICATIONS .....</b>	<b>82</b>
<b>APPENDIX 1. –SCANIP .....</b>	<b>83</b>

# **1. PRODUCT FEATURES**

## **1.1 Product Introduction**

The NVR is a storage media of digital video image, which uses hard disk drives instead of NAS devices to store video. This storage media provides the user with the power of remote control of the Internet. It's an extremely stable and reliable device because it is a stand-alone system. Its local operations are very similar to the DVR's interface, hence if the user is familiar with the DVR s/he will find this media to be most convenient. You don't need to design any analog lines yourself, just use the current existing network lines since the device is a digital one. Again, where the NAS is a passive device, the NVR is an active one, which automatically, instantly and directly detects all events without having to detour via the LAN Camera like the NAS.

Additionally, with the NVR you don't have to rely on a PC to save any images, because this device has done so already, being the best possible storage media for the LAN Camera.

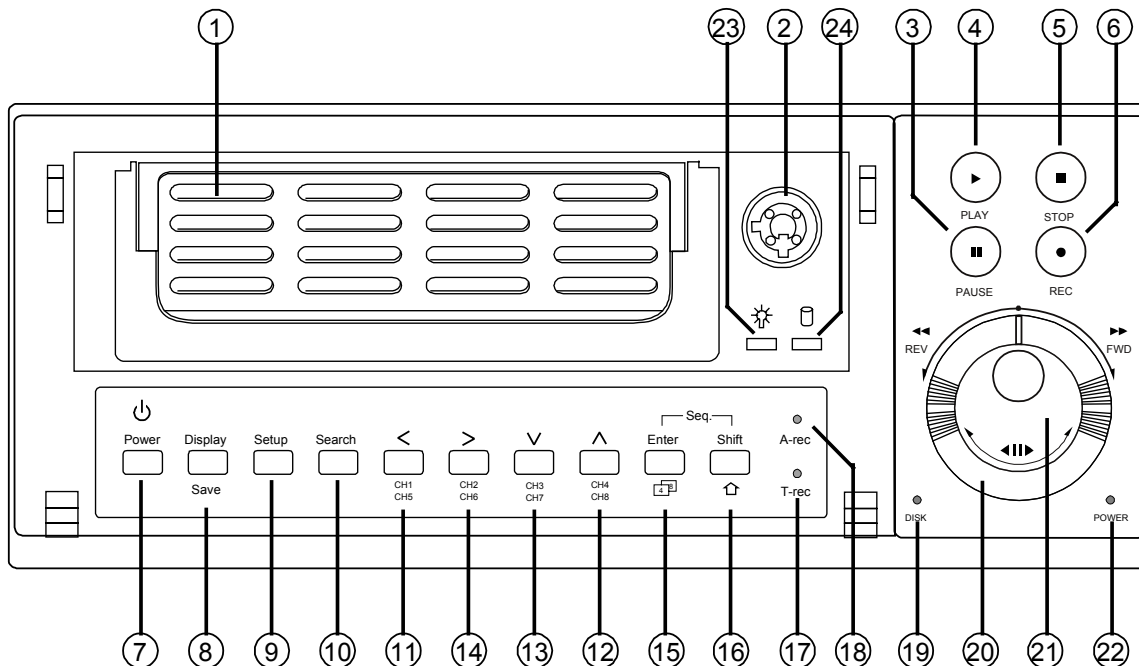
## **1.2 Product Features**

- \* Digital recorder for LAN the Camera.
- \* Maximum link-up of 8 LAN Cameras.
- \* Zoom in/out available for every LAN Camera.
- \* Compression method: MJPEG.
- \* Maximum 2 hard-disk drive capability. (One removable)
- \* Hard-disk drive hot-swapping capability.
- \* Pre-alarm image recording.
- \* Capable of backup with various known FTP server.
- \* Time-lapse and real-time recording.
- \* Refresh rate up to 30 IPS (25 IPS for PAL).
- \* Alarm I/O.
- \* Image quality selectable at 5 different levels for recording.
- \* Event/Timer/Alarm recording mode.
- \* Quick search by time, alarm, event, and recording list.
- \* Fast and slow playback of recorded video at various speeds.
- \* Single-picture playback.
- \* On-screen setup menu, title and system timer.
- \* Password protection.
- \* Motion detection: user can select the range and 5 levels of sensitivity of detection.
- \* Automatic search of all available LAN camera within the Ethernet.
- \* Disk-full warning and operation status LEDs.
- \* RS-232 communication port.
- \* Remote control via RS-232 and Ethernet ports
- \* Power interruption recovery.

- \* High stability and reliability.
- \* Operation-status record log.
- \* Distribution of live and recorded images throughout the TCP/IP network environment.
- \* Powerful PC software.
- \* Web browser: IE.
- \* Audio function included.
- \* Built-in SD card slot for copying image to SD card.
- \* Supports the DHCP protocol.

## 2. DESCRIPTION OF THE FRONT/REAR VIEW

### 2.1 Front View



① **Hard-disk drive compartment:**

The compartment allows you to install a hard disk drive mostly for backup purposes. Make sure the drive is well secured with the mounting screws in the mobile rack before you put the rack into the compartment. And remember to turn on the power of the compartment by locking it.

② **Hard disk compartment lock:**

The key lock secures a hard disk in place. Unlock the compartment before you remove the hard disk from the slot without turning off the device.

③ **PAUSE button:**

In a playback display, press this to freeze the display. During the freeze, press to display one frame/field of a picture at a time in the forward direction. (Illuminate green in PAUSE mode.)

④ **PLAY button:**

Press to play back a recorded video from the hard disk. (Illuminate green in PLAY mode.)

⑤ **STOP button:**

Press to stop playing back a recorded video or recording video into a hard disk. (Illuminate green in STOP mode.)

⑥ **REC button:**

Push to start recording video into a hard disk while in the live display mode. (Illuminate red in REC mode.)

⑦ **POWER button:**

Press this button for at least 3 seconds to power off. Press again to activate the device.

⑧ **DISPLAY button:**

Press to show the system operation status on the screen.

In the LANCAM SETTING mode, use these buttons to display the desired LAN Camera image on the screen.



⑨ **Setup/Save** button:

Press this to enter the setup menu. Press again to exit the setup mode.

In SD card backup mode, press to save the desired still image to SD card.

⑩ **Search** button:

Press to enter the search mode to access recorded video.

In the LANCAM SETTING mode, use these buttons to search for the desired LAN Camera in the LAN.

⑪⑭ **Left / Right (CH1-CH5 / CH2-CH6 )** buttons:

In setup menu/ search mode, press these two buttons to highlight desired items in the menu setup mode.

In the live mode, press ⑪ or ⑭ buttons to select channel 1 or 2 respectively to get a full-screen display. In order to display channel 5 or 6, please press **Shift** button while pushing ⑪ or ⑭ buttons respectively to see the selected channel.

In the play mode, press ⑪ or ⑭ buttons to see channel 1 or 2 respectively, first as a zoom -in, small-screen display, next as a full-screen display. Similarly, in order to display channel 5 or 6 in the play mode, press **Shift** button while pushing ⑪ or ⑭ buttons respectively to see the selected channel, first as a zoom-in, small-screen display, and next in a full-screen view.

⑫⑬ **Up / Down ( CH4-CH8 / CH3-CH7 )** buttons:

In setup menu/ search mode, press these two buttons to select the desired contents for programming in the setup menu mode.

In the live mode, press ⑫ or ⑬ buttons to select channel 4 or 3 respectively to get a full-screen display. In order to display channel 8 or 7, please press **Shift** button while pushing ⑫ or ⑬ buttons respectively to see the selected channel.

In the play mode, press ⑫ or ⑬ buttons to see channel 4 or 3 respectively, first as a zoom -in, small-screen display, next as a full-screen display. Similarly, in order to display channel 8 or 7 in the play mode, press **Shift** button while pushing ⑫ or ⑬ buttons respectively to see the selected channel, first as a zoom-in, small-screen display, and next in a full-screen view.

⑮ **Enter** Button:

Press to enter a selected item and save the setting in the menu setup mode.

In the live or play mode, this button enables the user to access the multiple-channel screen display. Pressing this button repeatedly will enable a sequential display in the following order: first, a quad-mode display of channels 1-4, and then, 5-8, and a multiple-channel display of channels 1-8, in succession.

⑯ **Shift** button:

Press **Shift** button while pushing either the **Left / Right** buttons, or the **Up / Down** buttons, to see any corresponding channel between channels 5-8.

Press **Shift** and **Enter** buttons simultaneously for a sequential display in the exact same order given above. (please refer to the "**NOTE**" given below)

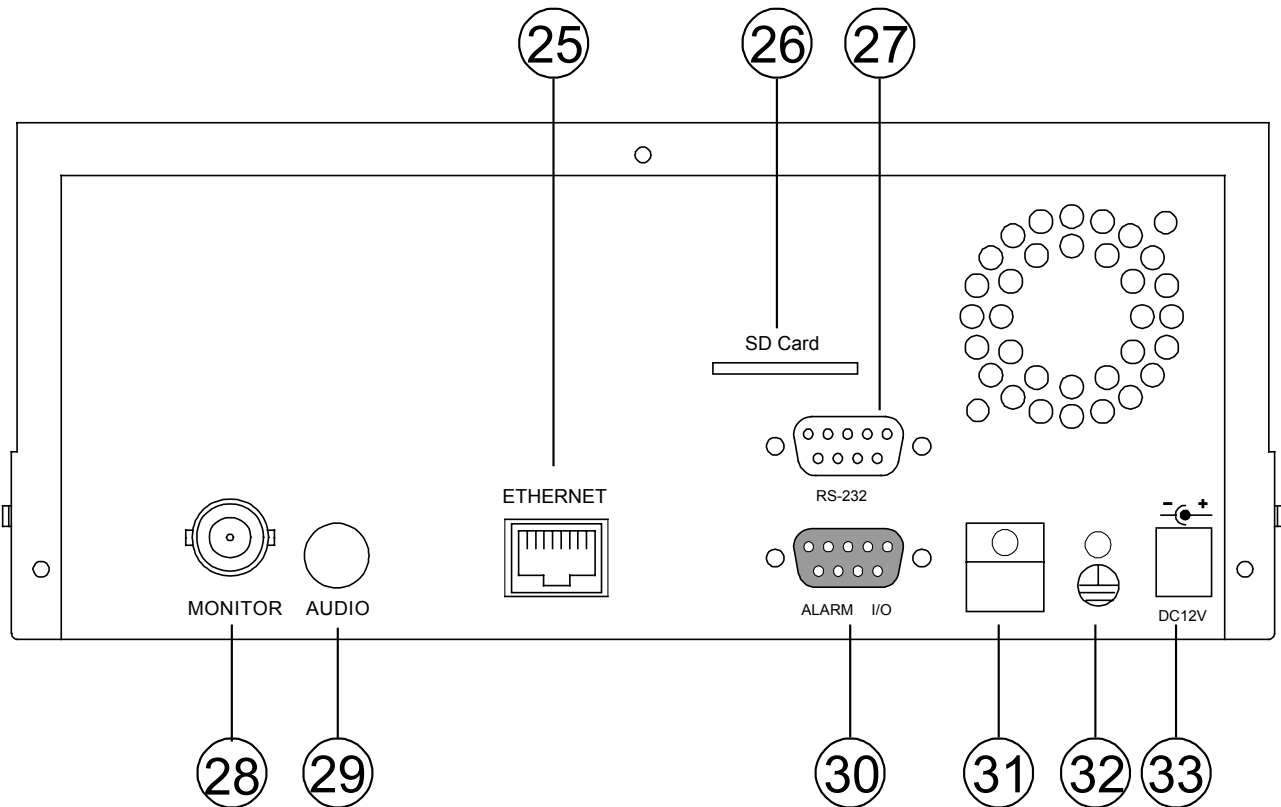
⑰ **T-rec Indicator**:

This indicator of the timer recording mode lights up to signal the scheduled record setting is on.

- ⑱ **A-rec Indicator:**  
This indicator of the alarm recording mode lights up to indicate the alarm record setting is on.
- ⑲ **DISK Indicator:**  
The indicator shows the operation status of the unit's hard-disk drives. The green light indicates the hard-disk drive is storing or retrieving data. The red light signals the hard-disk drive is filling up. The orange light indicates the hard-disk is retrieving at disk-full status.
- ⑳ **Shuttle Ring:**  
The shuttle can be moved forward and backward for playback in either direction. Turn this left to play a recorded video in the reverse direction at faster or slower speeds than the recorded speed. Turn this right to play a recorded video in the forward direction at faster or slower speeds than the recorded speed.
- ㉑ **Jog Dial:**  
This dial can act in both a forward and a backward direction, as well as step by step. Turn this left to play a recorded video in the reverse direction. Turn this right to play a recorded video in the forward direction.
- ㉒ **POWER Indicator:**  
Indicates the power status of the unit. The green light indicates the hard disk drive is activating. The orange light signals the hard disk drive is power stand by.
- ㉓ **Mobile Rack Power LED:**  
Indicates the power status of the Mobile Rack. The green light indicates the Mobile Rack is activating.
- ㉔ **Mobile Rack HDD LED:**  
Indicates the HDD status of the Mobile Rack. The orange light indicates the HDD is storing or retrieving data.

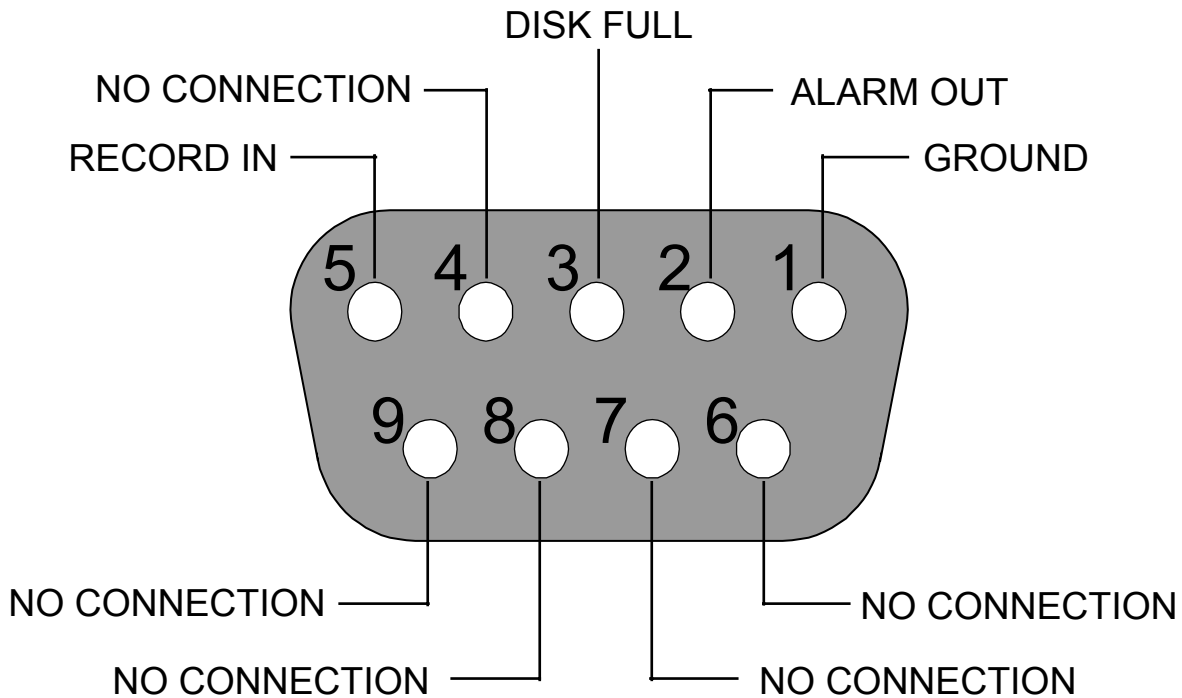
**NOTE: Press “ Enter ” and “ Shift ” simultaneously in order to view all the channels, one by one, in sequential single-channel succession, followed by an 8-channel display, a quad-mode display of channels 1-4, and channels 5-8, and then a multiple-channel viewing, after which you have this exact same sequential order of display indefinitely.**

## 2.2 Rear View



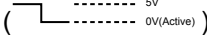
- ②⑤ **ETHERNET 10/100** Connector: This is one standard RJ-45 connector for 10/100 Mbps Ethernet networks.
- ②⑥ **SD CARD** Slot: This is used for system software updating and archiving/accessing critical images.
- ②⑦ **RS-232** Port: The RS-232 communication port functions as a connector to an external control device. Please refer to **RS-232 Protocol** for more details.
- ②⑧ **MONITOR** Connector: The connector provides the unit's composite video live signal if connected to a display device.
- ②⑨ **AUDIO OUT**: This provides the unit's audio signal to a speaker.
- ③① **ALARM I/O**: This is a 9-PIN D-SUB connector including **GROUND**, **ALARM OUT**, **DISK FULL**, and **RECORD IN** for connecting with external devices. Please refer to the next section for details.
- ③② **Wire Catch**: The wire catch secures the power cord and keeps it in place (so that it does not droop or hang loosely).
- ③③ **Ground Screw's**: The ground screw is for chassis terminal.
- ③④ **Plug Inlet**: The inlet connects to an external power supply. Connect 12 V DC UL Listed Class 2 Power Supply.

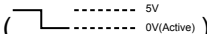
## 2.3 ALARM In/Out



### THIS FIGURE IS LOOKED FROM THE REAR VIEW

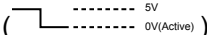
1. **GND:** Ground Contact.

2. **ALARM OUT (OUTPUT):** This is an alarm output trigger. Connect this to external devices such as buzzers or lights. (  )

3. **DISK FULL (OUTPUT):** This is a disk full output trigger. Connect this to external devices such as buzzers or lights. (  )

4. **NO CONNECTION**

5. **RECORD IN (INPUT):** This pin connects to a record trigger device for starting a record.

(  )

6. **NO CONNECTION**

7. **NO CONNECTION**

8. **NO CONNECTION**

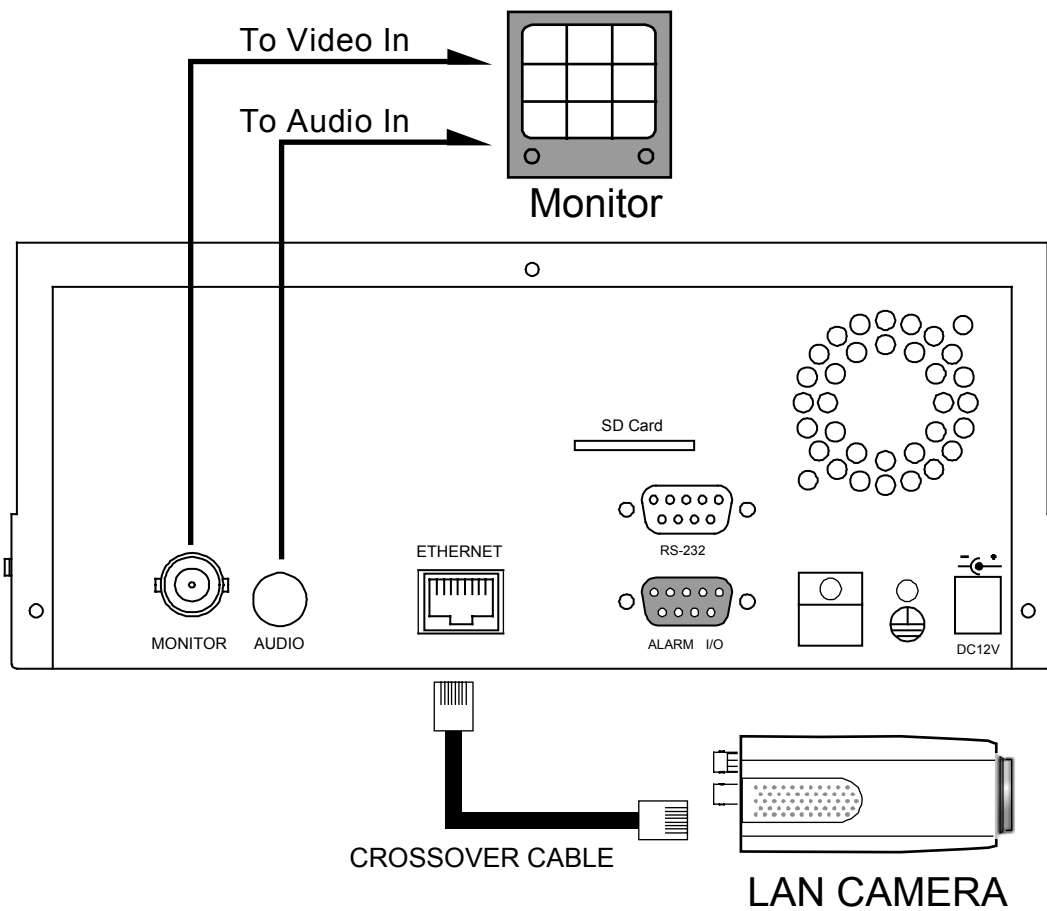
9. **NO CONNECTION**

### 3. INSTALLATION

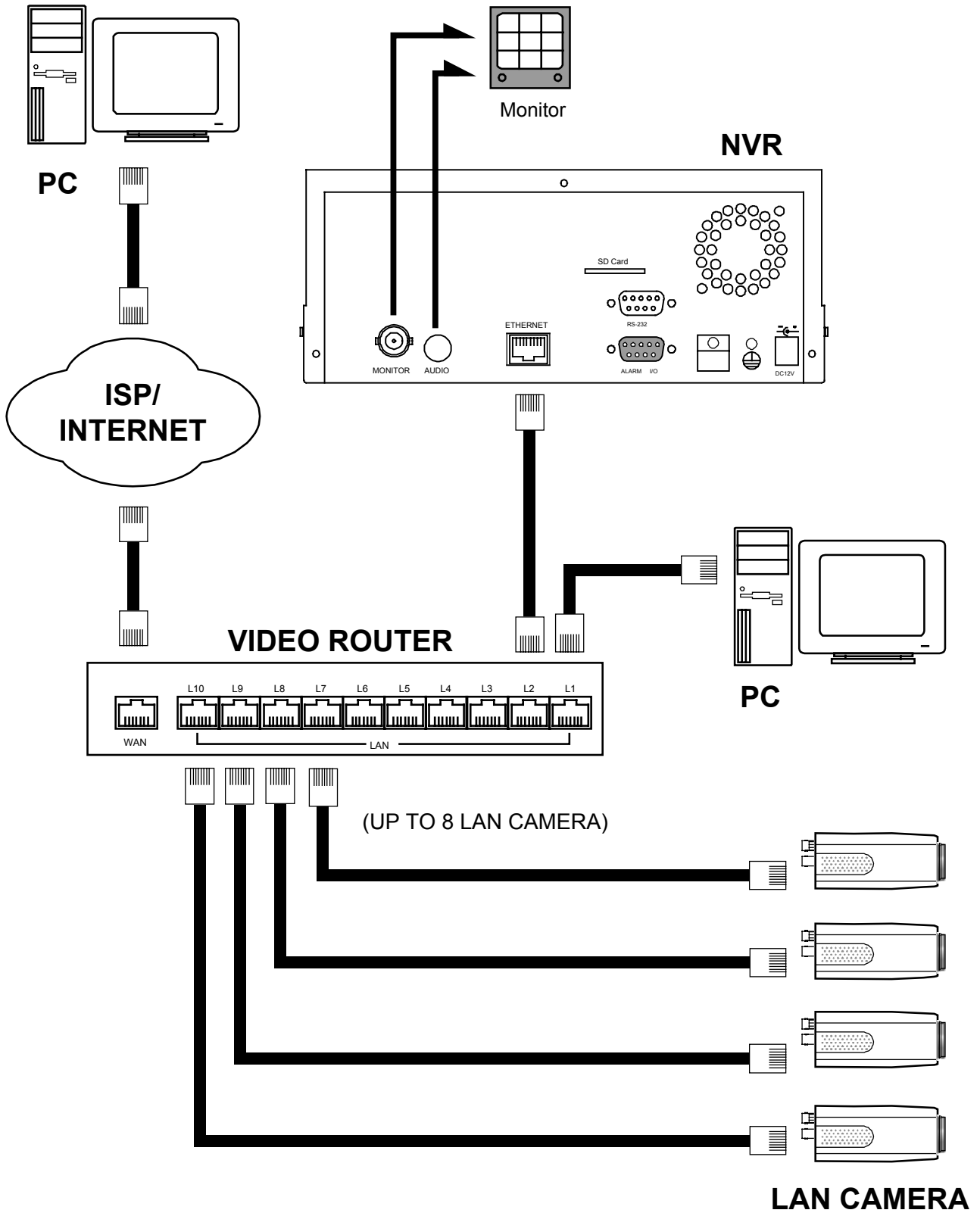
Please follow the instructions and the diagram below to set up the system.

#### 3.1 Basic Connection

##### CONNECTING WITH A SINGLE CAMERA



# LANCAM, NVR, ROUTER, CONNECTION STRUCTURE



### 3.2 Hard-Disk Drive Installation

The NVR is equipped with two compartments of hard disk drive. The unit usually comes with one hard-disk drive installed in the compartment HD1, which is default-configured as a master. If you need a second hard-disk drive to be installed in the compartment HD2 (Mobile), please contact your distributors or installers for specific instructions on how to install it. Please don't serve yourself before consulting your installers. If there is only one hard-disk drive in the mobile compartment, please set the **HD2 USAGE** option to **REC** (Please refer to section 5.6) before proceed recording function. The jumper-settings arrangement of installed hard-disk drives for the system (Table 3.2 A.) is shown in the tables below.

**Table 3.2 A. The jumper settings of hard disk drives in the system**

	Location	Jumper
IDE 1	Compartment HD 1	Master (Default)
IDE 2	Compartment HD 2	Master

**Table 3.2 B. Compatible hard-disk drives**

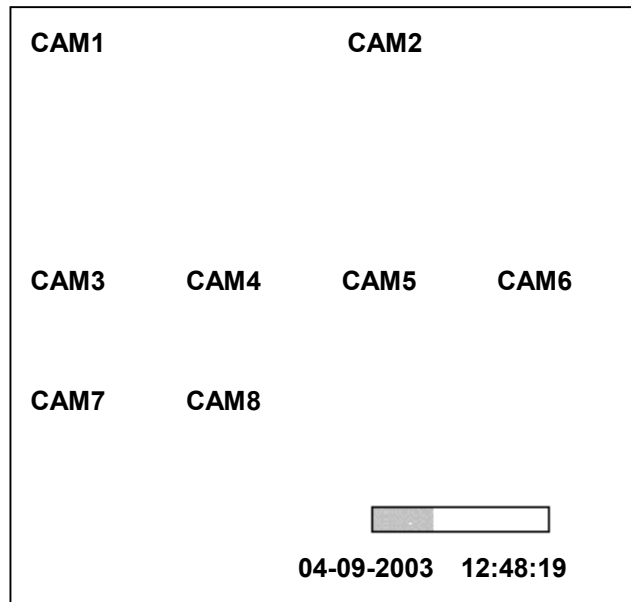
Manufacturer	Model	Capacity	Rotation
<b>Western Digital</b>	WD800AB	80GB	5400 RPM
	WD1200AB	120GB	5400 RPM
	WD800BB	80GB	7200 RPM
	WD1200BB	120GB	7200 RPM
	WD1800BB	180GB	7200 RPM
	WD2000BB	200GB	7200 RPM
	WD2500JB	250GB	7200 RPM
<b>Seagate</b>	ST380020A/P	80GB	5400 RPM
	ST340810A/P	40GB	5400 RPM
	ST320014A	20GB	5400 RPM
	ST340015A	40GB	5400 RPM
	ST380012ACE	80GB	5400 RPM
	ST3120025ACE	120GB	5400 RPM
<b>Maxtor</b>	4A160J0-1A	160GB	5400 RPM
	4R080L0-1	80GB	5400 RPM
	6Y120L0-1	120GB	7200 RPM
	6Y200P0-1A	200GB	7200 RPM
	6Y250P0-1A	250GB	7200 RPM
<b>SAMSUNG</b>	SV0802N	80GB	5400 RPM
	SV1203N	120GB	5400 RPM

**NOTE: Hard-disk drives not shown on this list have not been tested by the engineering team and are not recommended for use with this product. For the latest updated list on the recommended hard disk drives, please contact your dealers or distributors.**

### 3.3 System Information

You can display system settings information as shown on **Table 3.3 A** below at any time by pressing the **Display** button (8). In the playback mode, the recorded video information is displayed. In the live or recording mode, the Manual Recording information is displayed. Each sequential press of the **Display** button (8) displays a different message detailed in the following example. By default, the unit displays time, date, and an indicating bar of capacity status on a monitor as shown next.

#### Default display



Press the **Display** button (8) once; the NVR will display the following sample message plus the default display. Press the **Display** button (8) again; the unit will not display any OSD message. Press the button one more time to back to the default display.

Table 3.3 A.

CH	LANCAM IP		FX
1	192.168.001.250	LIVE	19 227K
2	192.168.001.020	LIVE	19 221K
3	192.168.001.030	- - -	
4	192.168.001.040	OFF	
5	192.168.001.050	OFF	
6	192.168.001.060	OFF	
7	192.168.001.070	OFF	
8	192.168.001.080	OFF	
IP : 192.168.001.205 DHCP:OFF NTSC			
	HD SIZE POS		
	1 20 G 39.5% R	11 HR (HD1)	
	2 39 G 0.0% P		
04-09-2003 12:48:19			

#### Description of Table 3.3 A

(CH): Channel  
 (LANCAM IP): LAN Camera IP address  
 (LIVE): The LAN Camera activated  
 (OFF): The LAN Camera inactivated  
 (19): The channel current display speed rate, 19 images/sec  
 (): Disconnection; (): Alarm; (): login error;  
 (): motion; (): Audio; (): Timer  
 (227K): The LAN Camera bandwidth  
 (LANCAM IP : 192 . 168 . 001 . 205): Setting of the Ethernet communication, 192.168.001.205  
 (DHCP:OFF): Only use manual setup IP address  
 (NTSC): NTSC system  
 (): Indicate which HDD is activated  
 (HD): Hard disk Compartment  
 (SIZE 20G): The capacity of the installed hard disk  
 (POS): Percentage of system; R: Recording; P: Playback  
 11 HR (HD1): Per minute change showing the total recording time.  
 (FX): Cannot operate at now

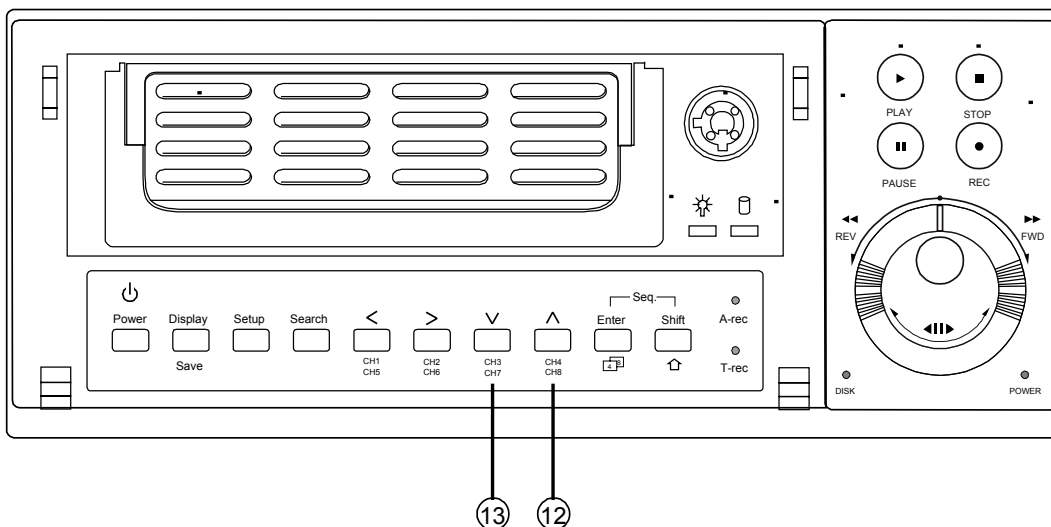


### 3.4 Updating System Software

If the system software of the NVR-2018 needs to be upgraded, please take the following steps to safely update it.

**Important: Before carrying out the following procedures, please ensure the SD card is working and the file of system software is intact**

1. Create a directory named **NVRVIDEO** in the SD Card; if the directory is already existed, move to Step2.
2. Copy the file of **MULTI.BIN** to the **NVRVIDEO**-directory.
3. If NVR is running, please turn off NVR first.
4. Insert the SD card into the built-in SD slot of the unit.
5. Hold down the **12** Up and **13** Down buttons simultaneously, and then turn on the unit.
6. Keep holding down the buttons until the NVR-2018 sounds a tone and display the message “**XXXXXX BYTES READ**” Now the NVR-2018 is updating the system software, which will take approximately 60 seconds to process.
7. Restart the unit when the device sounds a tone twice and displays the messages “**PROGRAMMING END**” and “**PLEASE RESTART**”. The process is complete.  
(If you have already followed the procedure 1~5. the unit, however, not being able to power on. Please first check if the SD card you are using is functioning and the file is intact. And then start procedures 1 ~ 5 all over again.)
8. Verify the version of the system software. (Please refer to section 5.7 VERSION option)



**Warning: Don't Interrupt the process while the unit is updating itself and proceed with a SD card containing with no system software of the unit, which would cause the unit hang on.**

## 4. BASIC OPERATIONS

This section shows you how to operate and manage the NVR when it gets in the way.

### 4.1 Configuring Recording Settings

#### Recording Time settings (Image Resolution and Image Quality Setting)

Recording time will vary depending on the image size, quality, and the capacity of the hard-disk drives. Generally, the NVR comes with a built-in hard-disk drive for continuous recording under most recording conditions. The table below shows the possible recording times based on a 20GB hard-disk drive at certain refresh rates and the corresponding image quality. With one or more hard-disk drive(s) in operation, please calculate the recording time using the table below in accordance with your requirement. For example, if the unit is set to record images with **HIGHEST** quality at a **352 X 240** resolution, and normally a 20GB hard-disk drive will be filled in 13 hours (See the gray area in the table). If the total capacity of 80GB hard-disk drives is in use under the same refresh rate, image resolution and image quality, it will be filled in 52 hours (4 times the rate of a 20GB hard-disk drive).

<b>( 352 X 240 )</b>				
<b>Audio OFF</b>		<b>Possible Recording Time HDD=20GB ( hour )</b>		
<b>Image Quality</b>	<b>HIGHEST</b>	13	19	37
	<b>HIGH</b>	18	25	52
	<b>MEDIUM</b>	24	32	66
	<b>LOW</b>	29	44	81
	<b>LOWEST</b>	43	66	137
<b>Refresh Rate ( Image/Sec )</b>		30	20	10
<b>REC Time Mode</b>		2 hr	4 hr	6 hr

<b>( 720 X 480 )</b>				
<b>Audio OFF</b>		<b>Possible Recording Time HDD=20GB ( hour )</b>		
<b>Image Quality</b>	<b>HIGHEST</b>		11	18
	<b>HIGH</b>		13	24
	<b>MEDIUM</b>		17	31
	<b>LOW</b>		23	48
	<b>LOWEST</b>		39	76
<b>Refresh Rate ( Image/Sec )</b>		30	20	10
<b>REC Time Mode</b>		2 hr	4 hr	6 hr

**NOTE: Recording times on the tables above are estimated. For actual available recording time of a recording configuration, please refer to the system information of the NVR. (Please refer to section 3.3 system information for more details.)**

## 4.2 Recording Operations

This section details the way to record video into hard-disk drives. Before commencing with the recording function, please configure the recording setting properly according to your needs.

### 4.2.1 Manual Recording

When the NVR is in live display mode, take the following steps to start recording:

- (1) In live display, press the **REC** button (6) to record video into a hard disk drive with the corresponding programmed recording settings. The monitor should display a flashing **REC** message and the **REC** button (6) will light up indicating the NVR is in the recording status.
- (2) Press the **STOP** button (5) to stop recording any time.
- (3) To access just recorded video, please refer to section 4.4 for more details.

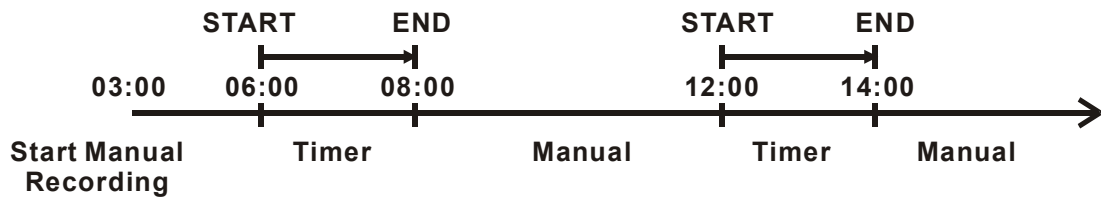
### 4.2.2 Timer Recording

Timer recording provides two periods of time each day in a weekly table which programs the NVR to turn on and off at specified times. This way the NVR will start and stop recording according to the programmed schedule. Please take the following steps to program the scheduled recording.

- (1) Press the **Setup** button (9) to enter the **MAIN MENU**.
- (2) Select the **CLOCK / TIMER / SEQ** and press the **Enter** button (15) to enter the **CLOCK / TIMER / SEQ** page.
- (3) Select the **TIMER – SET**.
- (4) Press the **Enter** button (15) to enter the **REC SCHEDULE** table.
- (5) ● You can set up by using the “<” button (11) and the “>” button (14) to locate the specific day/hour/minute and use the “^” button (12) and the “v” button (13) to set the day/hour/minute you wish.
  - You can also set up by using the **Shuttle Ring** and the **Jog Dial**. “◀” is the equal of the “<” button (11), “▶” is the equal of the “>” button (14), “▲” is the equal of the “^” button (12) and “▼” is the equal of the “v” button (13).
  - The time is displayed in a 24-hour clock format.
- (6) To activate the programmed recording schedule, set the **TIMER ENABLE** to **ON**. As the scheduled recording is on, the red indicator of the Timer Record (17) will be on as well. To deactivate it, set to **OFF**.
- (7) After scheduling is completed, press the **Enter** button (15) and set **OK** to save the setting or select **CANCEL** to leave the page without saving the settings.
- (8) Press the **STOP** button (5) during the scheduled recording to stop it at any time. If you wish to continue the scheduled recording, press the **REC** button (6) to proceed.

**NOTE:** You can proceed to start the scheduled recording from the current time if it is in the scheduled interlude as soon as setting is completed, and come out from menu to start recording.

**NOTE:** If you activate the recording function before the scheduled recording, the unit will operate recording as shown in the diagram below and keep those Images in different files.



**NOTE:** LIVE images may be freezed. But, it isn't a failure.

**MAIN MENU**

LAN CAMERA  
 RECORD / BANDWIDTH  
**CLOCK / TIMER / SEQ**  
 ALARM  
 COMMUNICATION  
 DISK  
 SYSTEM

GOTO CLOCK/TIMER/SEQ PAGE



**CLOCK / TIMER / SEQ**

CLOCK SETTING : SET  
**TIMER** : SET  
 SEQUENCER : SET

☐ MAIN PAGE

SET REC SCHEDULE



**REC SCHEDULE**

TIMER ENABLE: OFF

START	END	START	END
S	: 00:00-00:00	00:00-00:00	00:00
M	: 00:00-00:00	00:00-00:00	00:00
T	: 00:00-00:00	00:00-00:00	00:00
W	: 00:00-00:00	00:00-00:00	00:00
T	: 00:00-00:00	00:00-00:00	00:00
F	: 00:00-00:00	00:00-00:00	00:00
S	: 00:00-00:00	00:00-00:00	00:00

OK CANCEL

← → TO MOVE      ↓ ↑ TO CHANGE

**MAIN MENU**

LAN CAMERA  
 RECORD / BANDWIDTH  
**CLOCK / TIMER / SEQ**  
 ALARM  
 COMMUNICATION  
 DISK  
 SYSTEM

GOTO CLOCK/TIMER/SEQ PAGE



**CLOCK / TIMER / SEQ**

CLOCK SETTING : SET  
**TIMER** : SET  
 SEQUENCER : SET

☐ MAIN PAGE

SET REC SCHEDULE



**REC SCHEDULE**

TIMER ENABLE: ON

START	END	START	END
S	: 00:00-00:00	00:00-00:00	00:00
M	: 00:00-00:00	00:00-00:00	00:00
T	: 00:00-00:00	00:00-00:00	00:00
W	: 00:00-00:00	00:00-00:00	00:00
T	: 00:00-00:00	00:00-00:00	00:00
F	: 00:00-00:00	00:00-00:00	00:00
S	: 00:00-00:00	00:00-00:00	00:00

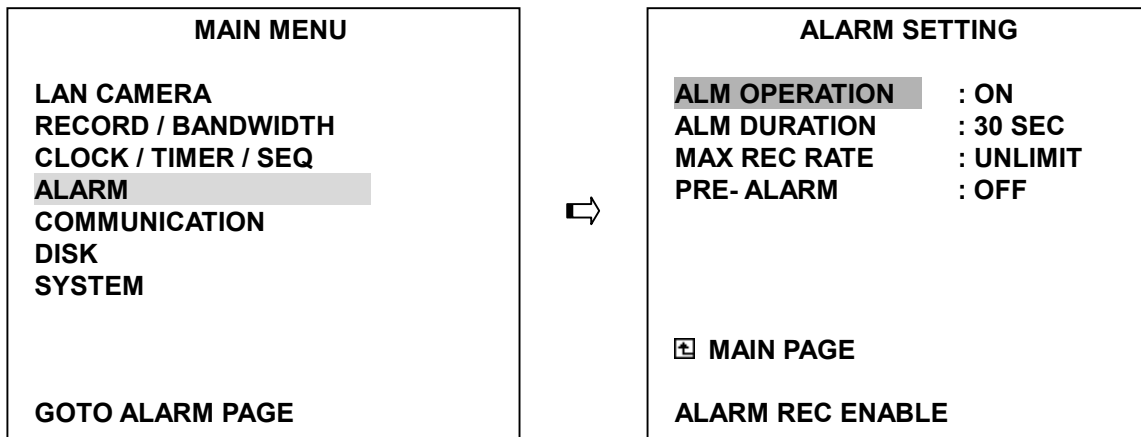
OK CANCEL

← → TO MOVE      ↓ ↑ TO CHANGE

### 4.2.3 Alarm Recording

Take the following steps to activate the programmed alarm recording. For **ALM OPERATION**, **ALM DURATION**, **MAX REC RATE**, and **PRE-ALARM** settings, please refer to section 5.4 for more details.

- (1) Press the **Setup** button **9** to enter the **MAIN MENU**.
- (2) Select **ALARM** and press the **Enter** button **15** to enter the **ALARM SETTING**.
- (3) Set the desired **ALM DURATION** and **MAX REC RATE** for use.
- (4) To activate the alarm recording, set **ALM OPERATION** to **ON**. To deactivate it, set **ALM OPERATION** to **OFF**.



- (5) To active the motion alarm recording, Select **MOTION SETTING** and press the **Enter** button **15** to enter the **MOTION SETTING PAGE**, set **MOTION ENABLE TO ON**, and set a suitable **SENSITIVITY** and **REGION** according to the video sources. (Please refer to the next section 4.2.4)

#### 4.2.4 Motion Detection

Take the steps detailed below to activate a programmed motion detection. For MOTION SETTING, as well as its two distinct functions of MOTION ENABLE and SENSITIVITY / REGION, please refer to section 5.4 for further details.

- (1) Press the **Setup** button ⑨ to enter the **MAIN MENU**.
- (2) Select the item termed "**LAN CAMERA**" and press the **Enter** button ⑮ to enter the **LANCAM SETTING** page.
- (3) Select the item termed "**MOTION**" and push the **Enter** button ⑮ to enter the **MOTION SETTING** page.
- (4) To activate the motion detection function, set "**MOTION ENABLE**" to "**ON**". To deactivate the function, set "**MOTION ENABLE**" to "**OFF**". The items termed "**OFF**" and "**ON**" switch all the channels in the **MOTION ENABLE SETTING** page off and on respectively as well. If you wish to select individual channels for viewing, select the item termed "**SET**" and activates your desired channels by pressing them "**ON**" while turning the rest "**OFF**". Confirm your choices by pressing "**OK**". If not, push "**CANCEL**".
- (5) In the **MOTION SETTING** page, select the entry termed "**SENSITIVITY / REGION**" and press the ">" button ⑭ to show all the channels in their order, each in turn. Use the "▲" button ⑫ and the "▼" button ⑬ to select a desired channel for setting. Press the **Enter** button ⑮ and set the channel in the **SENSITIVITY / REGION SETTING** page. Repeat the process for all other channels you choose.
- (6) To set "**SENSITIVITY**" and "**REGION**" for activation on the **SENSITIVITY / REGION** page, choose your degree of sensitivity and then push the **Enter** button ⑮. At once the legends "**OK**" and "**CANCEL**" appear at the bottom of the page. Now press the "<" button ⑪ and the ">" button ⑭ to confirm either "**OK**" or "**CANCEL**" respectively.

**MAIN MENU**

LAN CAMERA  
 RECORD / BANDWIDTH  
 CLOCK / TIMER / SEQ  
 ALARM  
 COMMUNICATION  
 DISK  
 SYSTEM

LANCAM SETTING

**LANCAM SETTING**

IP/ACCOUNT : SET  
 IMAGE : SET  
 AUDIO ENABLE : OFF  
 MOTION : SET

MAIN PAGE

MOTION SETTING



**MOTION SETTING**

MOTION ENABLE : ON  
 SENSITIVITY/REGION : CH1

LANCAM PAGE

SET MOTION ENABLE

**MOTION SETTING**

MOTION ENABLE : ON  
 SENSITIVITY/REGION : CH1

LANCAM PAGE

SET MOTION SENSITIVITY/REGION



**MOTION SETTING**

MOTION ENABLE : OFF  
 ON  
 SET

LANCAM PAGE

SET MOTION ENABLE

**MOTION SETTING**

MOTION ENABLE  
 SENSITIVITY/REGION : CH1  
 CH2  
 CH3  
 CH4  
 CH5  
 CH6  
 CH7  
 CH8

LANCAM PAGE

SET MOTION OF CH5




**MOTION ENABLE SETTING**

CH1	CH2	CH3	CH4
ON	ON	ON	ON
CH5	CH6	CH7	CH8
ON	ON	ON	ON

OK CANCEL

**SENSITIVITY / REGION SETTING**

SENSITIVITY HIGHEST  
 REGION ( 30, 25 ) - ( 90, 70 )

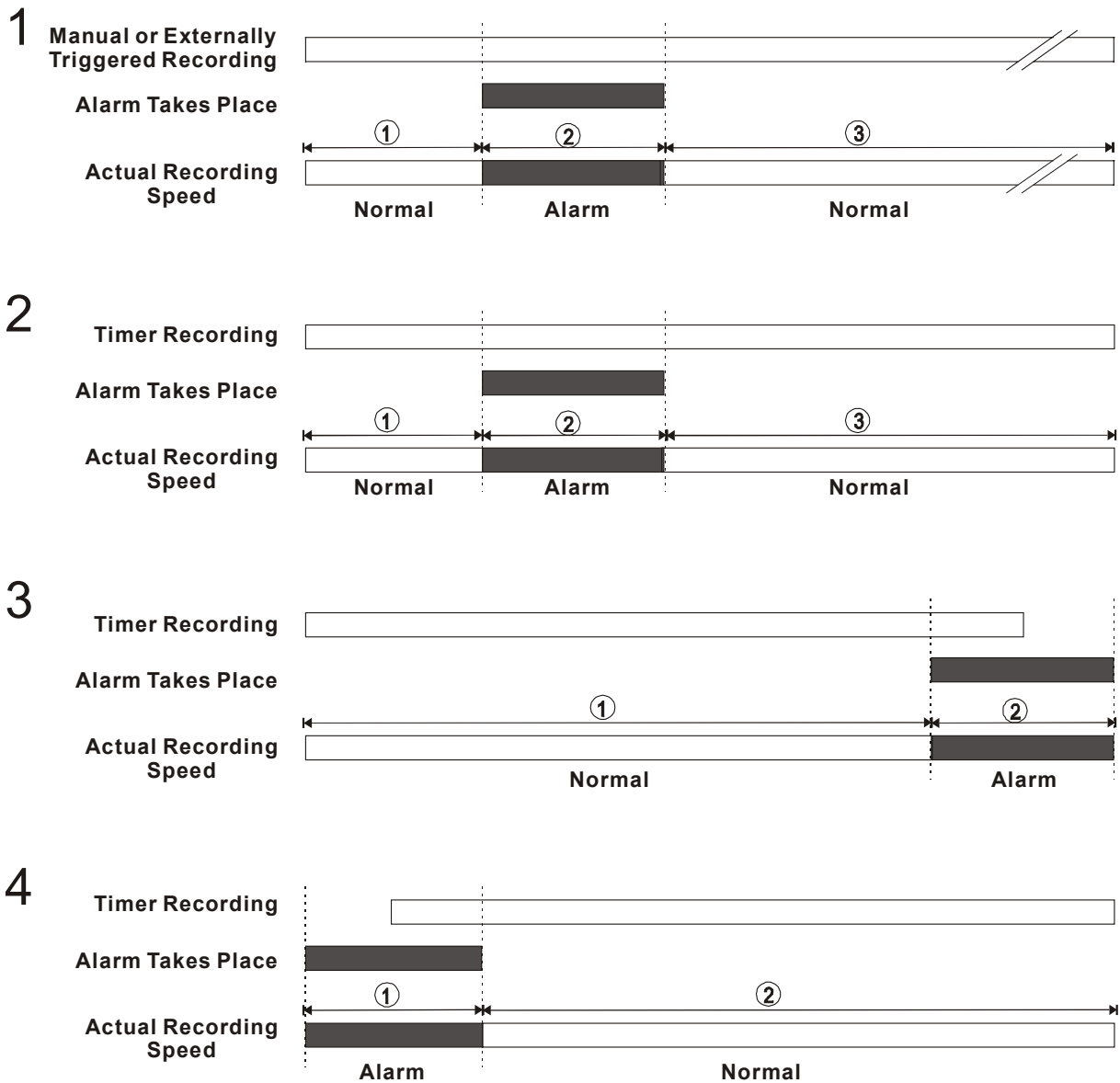
OK CANCEL 



## 4.2.5 Externally triggered Recording

By connecting the **RECORD IN** of ALARM I/O on the rear panel of the NVR, you can activate/deactivate the recording function of a NVR. Please refer to section 2.3 for more details.

**NOTE:** The status of recording operations when an alarm takes place are shown in the diagrams below.



## 4.3 Playback Operations

This section shows you how to operate the fast, slow, and single-picture playback functions, and details how the unit is to playback a file in a different operation status. Please refer to the following paragraphs specifying the relevant details. When playing a file, the monitor should display a flashing **PLAY** message and the **PLAY** button ④ will light up indicating that the NVR is in the playback status.

### Operation Status

#### A. From REC mode to Playback mode

(In live mode, directly press the **PLAY** button ④ to play a latest recorded video)

**REC** → [ **STOP** ] → [ **PLAY** ] ..... Play the latest recorded file  
.....▶  
[ Play to the end of the file ] ..... Show the ending message (use search functions or  
rewind to replay the file if required)  
.....▶ [ **STOP** ] → [ **PLAY** ] ..... Play the file from the stop position

#### B. Search to play back a particular recorded video

**Search** → [ **PLAY** ] ..... Play a selected file  
.....▶  
[ Play to the end of the file ] ..... Show the ending message (Search again or rewind to  
replay the file if required)  
.....▶ [ **STOP** ] → [ **PLAY** ] ..... Play the file from the stop position

### 4.3.1 Fast Forward/Reverse

There are 7 speeds available for playback: 1x, 2x, 4x, 8x, 16x, 32x and 100x

While playing back recorded video at recorded speed:

**Forward:** Turn the **Shuttle** dial ⑳ to the right to view the recorded video in the forward direction at a speed faster than the recorded speed. Each subsequent turn of the shuttle to the right increases the forward rate, as 2x, 4x, 8x, 16x, 32x and 100x.

**Reverse:** Turn the **Shuttle** dial ⑳ to the left to view the recorded video in the reverse direction at a speed faster than the recorded speed. Each subsequent turn of the shuttle to the left increases the reverse rate, as -1x, -2x, -4x, -8x, -16x, -32x and -100x.

**Normal:** Release the **Shuttle** dial ⑳ to return to the normal speed of playback.

### 4.3.2 Slow Forward/Reverse

There are 5 speeds available for a slow playback: 1/2, 1/4, 1/8, 1/16, 1/32.

While playing back recorded video at the recorded speed:

- (1) Press the **PAUSE** button ③ for the slow playback mode.
- (2) **Forward:** Turn the **Shuttle** dial ⑳ to the right to view the recorded video in the forward direction at a speed slower than the recorded speed. Each subsequent turn of the shuttle to the right increases the forward rate, as 1/2, 1/4, 1/8, 1/16, and 1/32.
- (3) **Reverse:** Turn the **Shuttle** dial ⑳ to the left to view the recorded video in the reverse direction at a speed slower than the recorded speed. Each subsequent turn of the shuttle to the left increases the reverse rate, as -1/2, -1/4, -1/8, -1/16, and -1/32.
- (4) **Normal:** Release the **Shuttle** dial ⑳ and then press the **PLAY** button ④ to return to the normal speed of playback.

### 4.3.3 Play Back Picture-by-picture

While playing back recorded video at the recorded speed:

- (1) Press the **PAUSE** button ③ for the picture-by-picture mode.
- (2) There are two ways, by PAUSE button or by JOG, available to play in the picture-by-picture mode, but the **PAUSE** button ③ can only function in a forward direction; the other, **JOG** dial ㉑, can act in both a forward and a backward direction, as well as picture-by-picture.

By PAUSE button ③ :

Press the **PAUSE** button ③ to display one frame/field of a picture at a time in the forward direction. **(When playing back video recorded by multi channel, each sequential press of the PAUSE button ③ will display each camera in sequence.)**

By JOG dial ㉑ :

Turn the **JOG** dial ㉑ clockwise to display one frame/field of a picture at a time in the forward direction. Turn the **JOG** dial ㉑ counterclockwise to display one frame/field of a picture at a time in the backward direction.

- (3) Press the **PLAY** button ④ to return to the normal speed of playback.

### 4.3.4 Play Back Recorded Video from a HDD of the mobile rack

To play back a recorded video from a HD2, take the following steps::

- (1) Press the **Search** button ⑩ to enter the search mode.
- (2) Press the ⑫ “▲” and ⑬ “▼” buttons, to select a video; press the ⑪ “<” and ⑭ “>” buttons, to flip over a page.
- (3) Use the search function to access desired recorded video. For specific operation details please refer to the next section 4.4 (Search Operations).

## 4.4 Search Operations

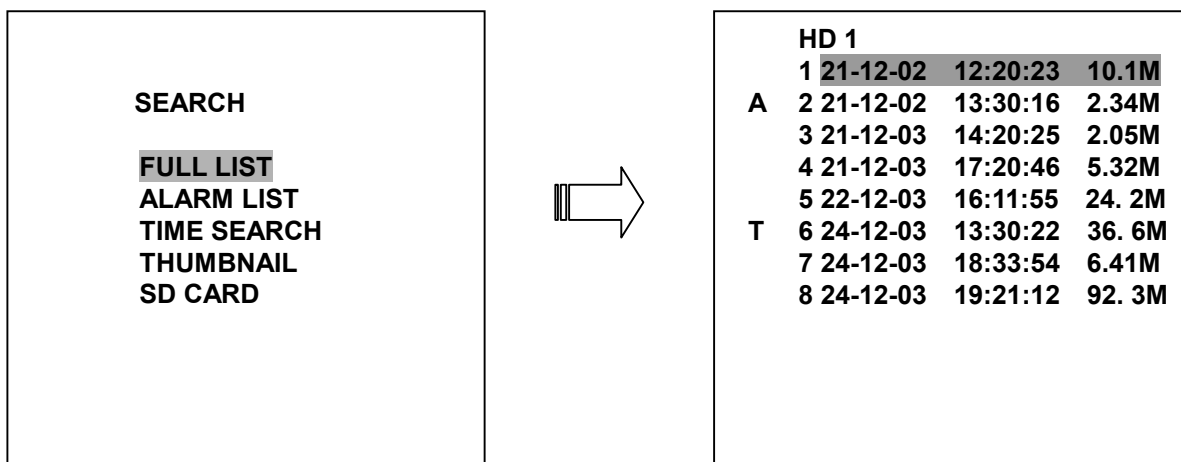
This section shows you how to access recorded video.

### 4.4.1 Full List Search

Take the following steps to proceed with the full-list search function.

- (1) Press the **Search** button (10) to enter the search mode.
- (2) Select the **FULL LIST** and press the **Enter** button (15) to access the complete list of recorded video.
- (3) Highlight the specific recorded video of your requirement and press the **Enter** button (15) to display the selected video.

(Key Operation: Press the (12) “^” and (13) “v” buttons, to select a video; press the (11) “<” and (14) “>” buttons, to flip over a page.)



**NOTE: T: Timer recording; R: External trigger recording; A: Alarm recording.**

**NOTE: The maximum number of lists, for a respective HDD, is 3000.**

**NOTE: Press the Display button (8) persistently to hide list.**

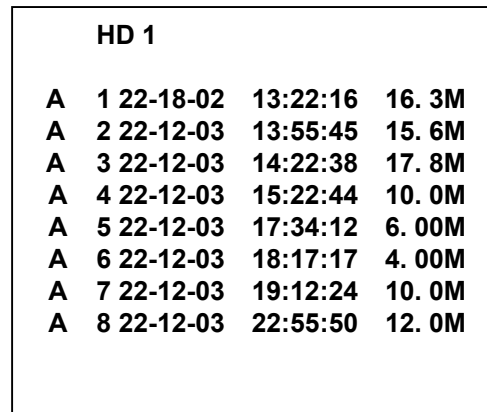
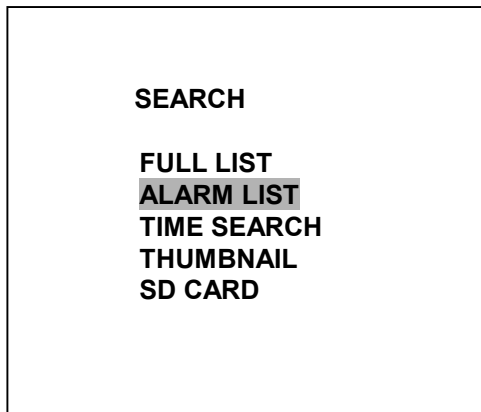
### 4.4.2 Alarm list Search

Take the following steps to proceed with the alarm-list search function.

- (1) Press the **Search** button (10) to enter the search mode.
- (2) Select the **ALARM LIST** and press the **Enter** button (15) to access the complete list of alarm-event recorded video.
- (3) Highlight the specific recorded video of your requirement and press the **Enter** button (15) to display the selected video.

(Key Operation: Press the (12) “^” and (13) “v” buttons, to select a video; press the (11) “<” and (14) “>” buttons, to flip over a page.)

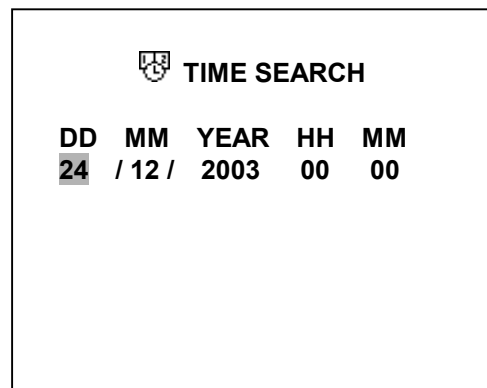
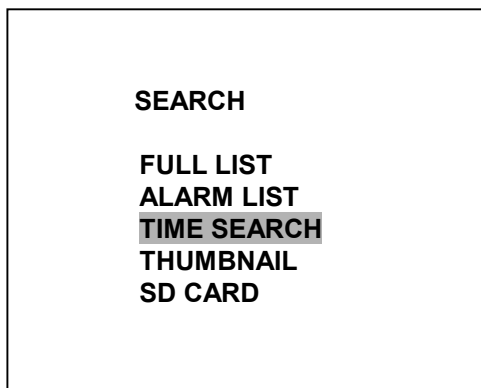
**NOTE: Press the Display button (8) persistently to hide list.**



#### 4.4.3 TIME Search

Take the following steps to proceed with the time-list search function.

- (1) Press the **Search** button (10) to enter the search mode.
- (2) Select the **TIME SEARCH** and press the **Enter** button (15) to access the time-setting page.
- (3) Set the time period you wish to search for the recorded video.
- (4) Press the **Enter** button (15) to start searching and displaying the concerned image.
- (5) If no video is found, please return to the time-setting page and repeat steps (3) and (4) again for another search.

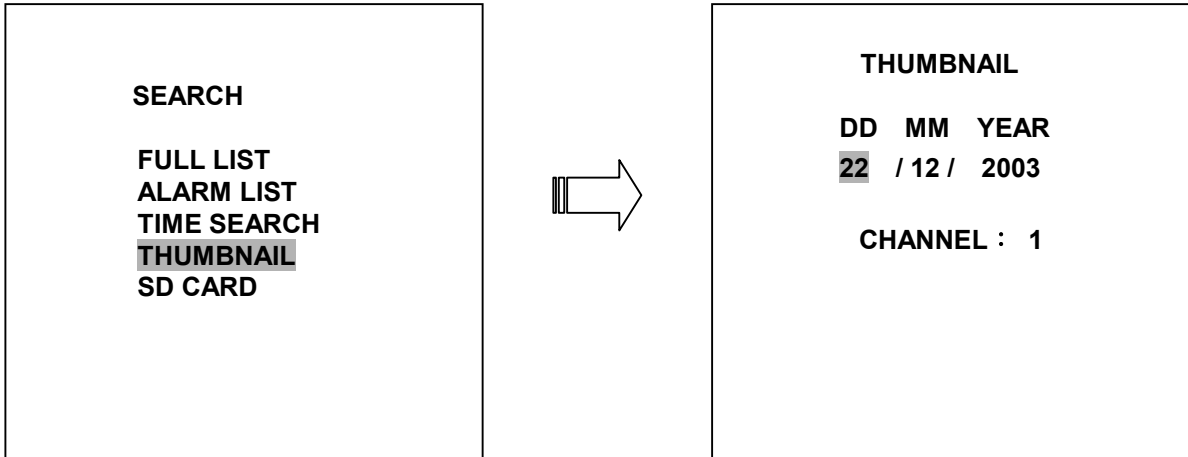


#### 4.4.4 THUMBNAİL Search

Take the following steps to proceed with the thumbnail search function.

- (1) Press the **Search** button (10) to enter the search mode.
- (2) Select the **THUMBNAİL** and press the **Enter** button (15) to access the thumbnail page.
- (3) Set the date you wish to search for the recorded video.
- (4) Press the **Enter** button (15) to start searching and displaying the concerned image.
  - You can set up by using the “<” button (11), the “>” button (14), the “^” button (12) and the “v” button (13) to move eye focus.
  - You can also set up by using the **Shuttle Ring** and the **Jog Dial** to move eye focus. is the equal of the “<” button (11), is the equal of the “>” button (14), is the equal of the “^” button (12) and is the equal of the “v” button (13).

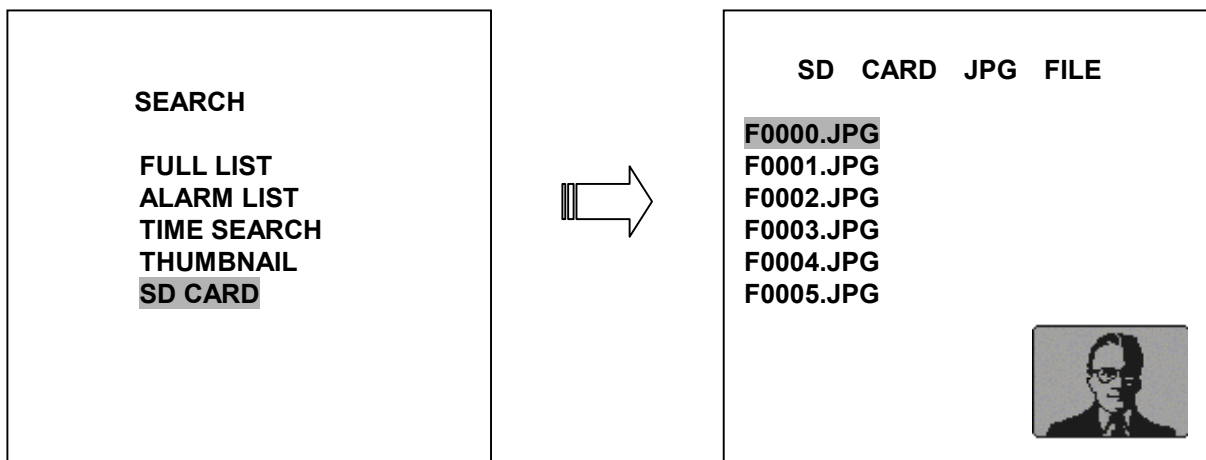
- (5) There are 5 levels of recording range modes to choose from: **1 Hour, 10 Minutes, 1 Minute, 10 Seconds** and **1 Second**. Select the specific field of your requirement and press the **Enter** button<sup>15</sup> to enter the next level. If you want to return the previous level, please press the **Setup** button <sup>9</sup>
- (6) Once reaching the critical point at any level, the user can start playback by just clicking the **PLAY** button <sup>4</sup>.



#### 4.4.5 SD CARD Search

Take the following steps to proceed with the SD card search function.

- (1) Insert a SD Card into the SD card slot of the rear unit.
- (2) Press the **Search** button <sup>10</sup> to enter the search mode.
- (3) Select the **SD CARD** and press the **Enter** button <sup>15</sup> to access the complete list of JPG files.
- (4) Highlight the specific JPG file of your requirement and press the **Enter** button<sup>15</sup> to display the image.
- (5) If you need another, please return to the SD card JPG file list page and repeat steps (3) and (4) again for another search.



**NOTE:** If you would like to delete JPG file in the SD card, please return to **SD CARD JPG FILE** list page and highlight the specific JPG file of your requirement and press the **Setup** button<sup>9</sup> and then select the **“Yes”** to delete the image.

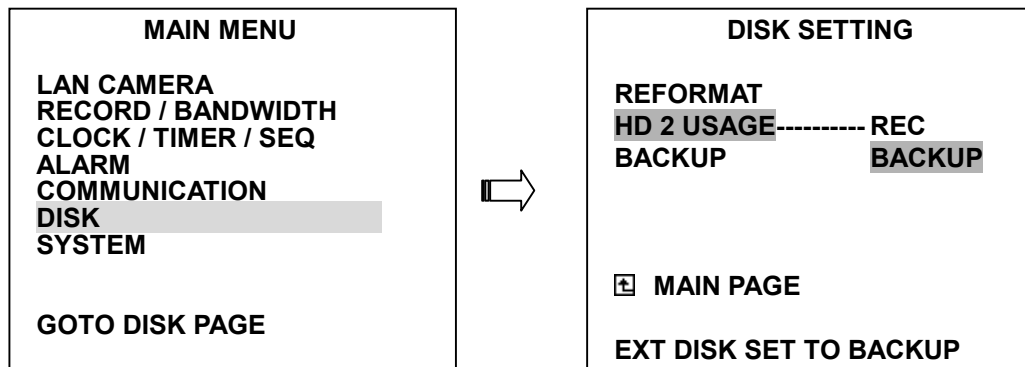
## 4.5 Backup Operations

### 4.5.1 Mobile Rack HD Backup Operations

There are three ways available to duplicate the recorded video from HD 1 (Fixed HD) to HD 2 (Mobile Rack HD). Please take the following steps to proceed.

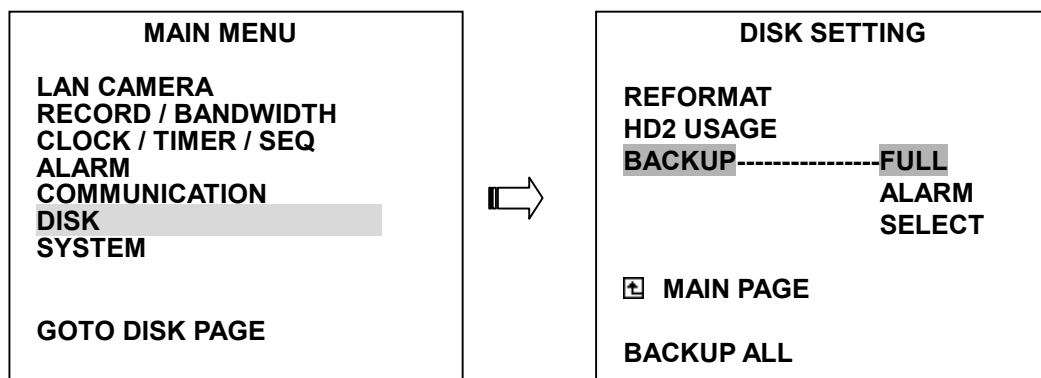
**(1) Set HD 2 to BACKUP first. Take the following steps.**

- Press the **Setup** button **9** to enter the setup mode and select the **DISK**.
- Highlight **DISK** and press the **Enter** button **15** to enter the **DISK SETTING** page.
- Then set **HD 2 USAGE** to **BACKUP**.



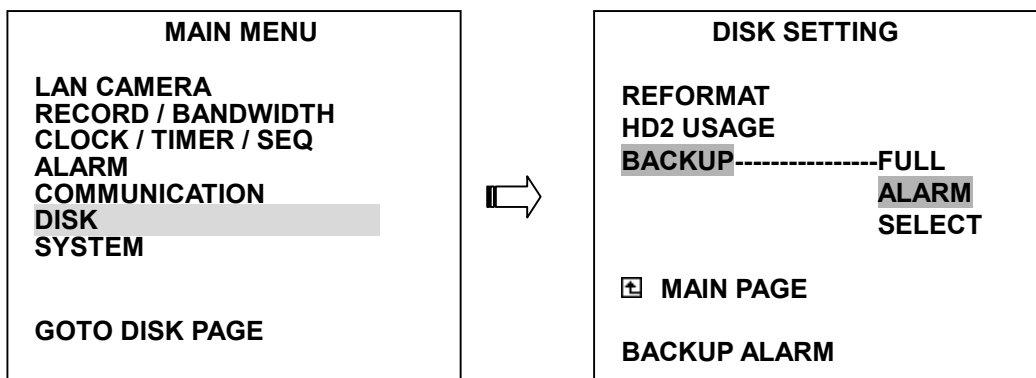
**(2) FULL:** Duplicate all the recorded video from HD1 to HD2.

- Stay on the **DISK SETTING** page.
- Use the “**^**” and “**v**” buttons, **12** and **13**, to highlight **BACKUP**, select **FULL**, then press the **Enter** button **15** to proceed.



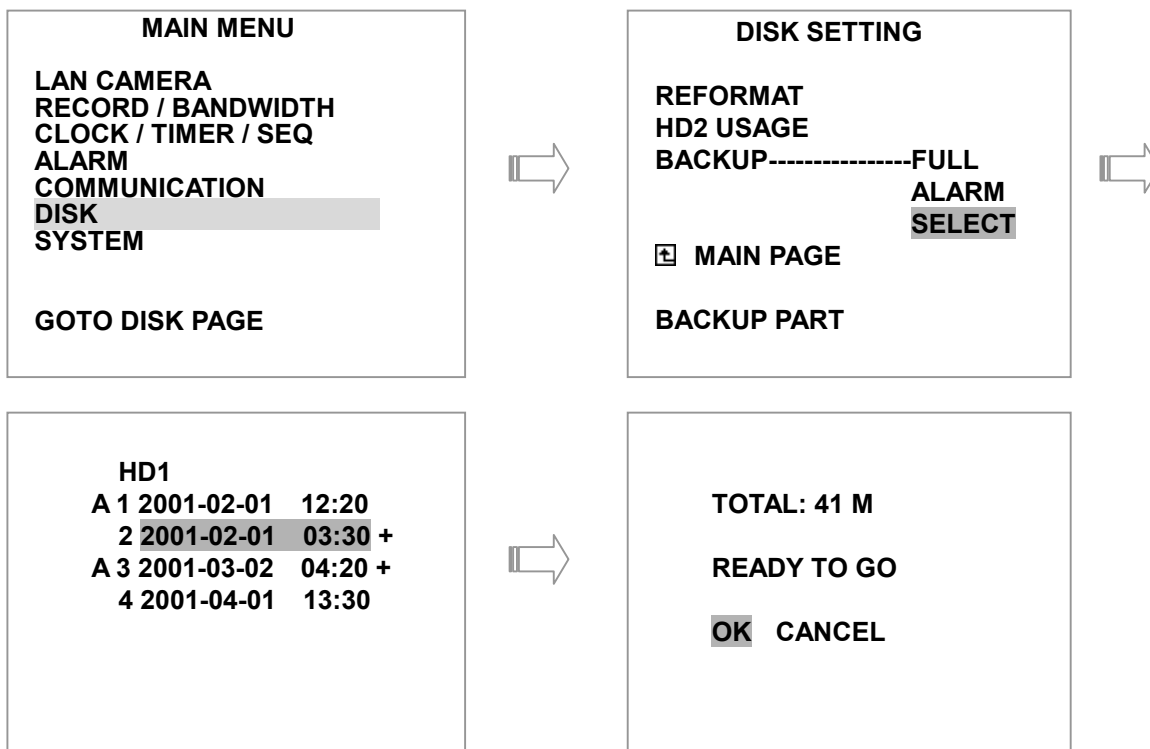
**ALARM:** Duplicate all the alarm-event recorded video from HD 1 to HD2.

- Stay on the **DISK SETTING** page.
- Use the “**^**” and “**v**” buttons, **12** and **13**, to highlight **BACKUP**; select **ALARM**, then press the **Enter** button **15** to proceed.



**SELECT:** Duplicate a particular recorded video from HD1 to HD2.

- Stay on the **DISK SETTING** page.
- Use the “^” and “v” buttons, (12) and (13), to highlight **BACKUP**, select **SELECT** and then press the **Enter** button (15) to list all the recorded video.
- Press the “^” and “v” buttons, (12) and (13), to select the desired clip and press the **Search** button (9) to mark it.
- After completing the selection, press the **Enter** button (15) to proceed.



**NOTE:** If the capacity of HD 2 is not sufficient to store all selected video, a warning message “HD2 SPACE NOT ENOUGH” will be displayed on the screen. Please, insert a larger capacity of hard-disk drive and start the process all over again.



## 4.5.2 Secure Digital Card (SD Card) Backup Operations

The SD card slot of the rear unit has three functions as shown below:

### 1. Archive Single image Clips into SD Card

Please take the following steps to archive a critical image in a SD card.

- (1) Insert a SD Card into the SD card slot of the rear unit.
- (2) Start playing back the recorded video.
- (3) Press the **PAUSE** button **③** to freeze the desired pictures.
- (4) Press the **Setup** button **⑨** to save the image in the SD Card.

The quantity of pictures that can be stored depends on the SD card capacity. It depends on SD card capacity how many pictures can be stored. You can have the saved images printed out in any computer. The image is stored in the JPEG compressed format. If more than one clip is stored in a SD card, file names will be assigned in sequence as shown below.

**SAVE TO J0000.JPG**

**SAVE TO J0001.JPG**

...

**SAVE TO J000N.JPG**

### 2. Backup the System setting info into SD Card.

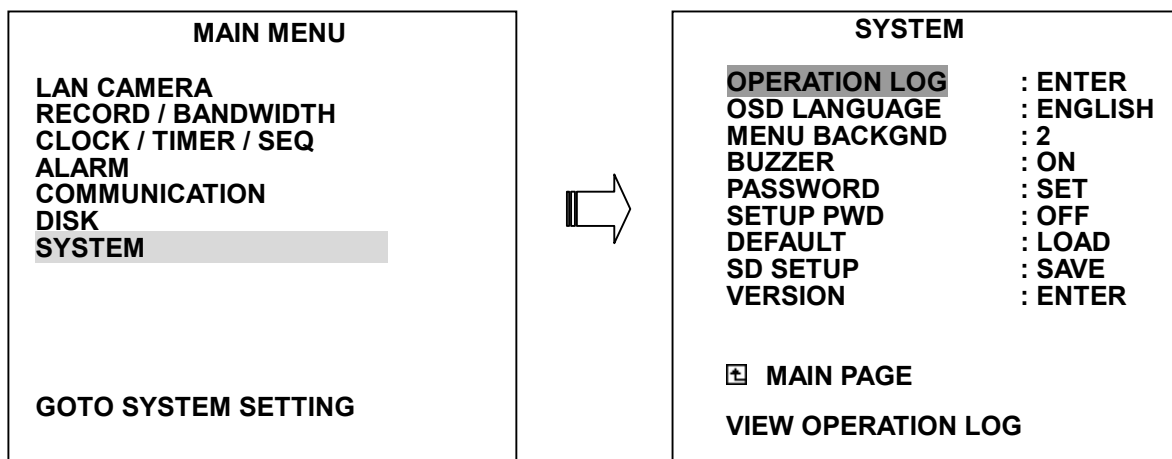
The NVR-2018 offers a quick setup method by using a SD card. If a user wants to set many NVR-2018 devices with the same settings, the NVR-2018 could save the whole setting in the SD card, then transfer it to another NVR.

#### Save the whole setting into the SD card:

- Insert a SD card into the SD card slot.
- Press the **Setup** button **⑨** to enter the setup mode and select the **SYSTEM**.
- Highlight **SYSTEM** and press the **Enter** button **⑮** to enter the **SYSTEM SETTING** page.
- Set **SD SETUP** to **SAVE**. Then the system setting info will auto save into SD card.

#### Transfer the system setting info of NVR to another:

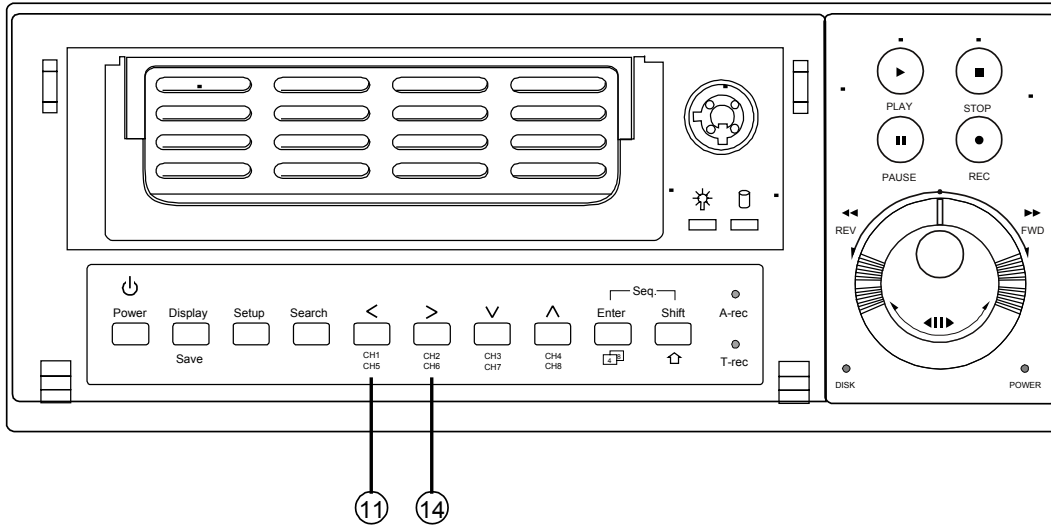
- Insert the SD card which has stored the system setting info into the NVR.
- Press the **Setup** button **⑨** to enter the setup mode and select the **SYSTEM**.
- Highlight **SYSTEM** and press the **Enter** button **⑮** to enter the **SYSTEM SETTING** page.
- Then set **SD SETUP** to **LOAD**.



### 3. Updating System Software (Please refer to section 3.4 for more details.)

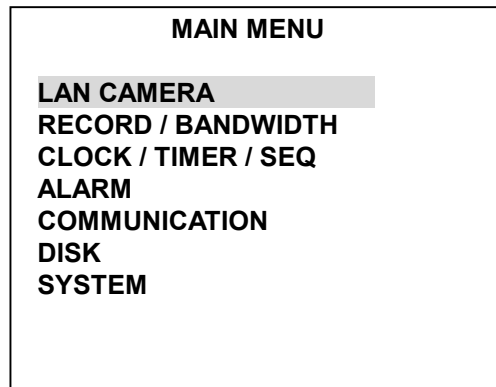
## 4.6 Key Lock Operation

The Key lock operation protects the unit against unauthorized use by disabling the entire front panel controls. Simultaneously press these two ⑪ “<” and ⑭ “>” buttons (as shown below) for at least 3 seconds to lock the unit; to release the **Key Lock**, simultaneously press these two buttons again.



## **5. MENU SETUP**

There are 6 categories for operation setting in the setup menu system as shown below. The following sections will instruct you step by step to configure the operation setting and state each menu's purpose and options. Press the **Setup** button ⑨ to access the setup menu. Once inside the menu system, the on-screen menu allows you to set up the key features of the unit. The functions of various buttons within the menu-setup mode are described in the paragraphs below.



### **KEY FUNCTIONS**

**Setup** button ⑨ :

Press to enter the setup menu. Press again to exit the setup mode.

“▲” “▼” buttons ⑫ and ⑬ :

Press to select the desired item or entry for setting.

“<” “>” buttons ⑪ and ⑭ :

Press to highlight the desired option or to select the context for setting.

**Enter** button ⑮ :

Press to enter the selected item and to save the setting.

**Shuttle Ring** ⑳ :

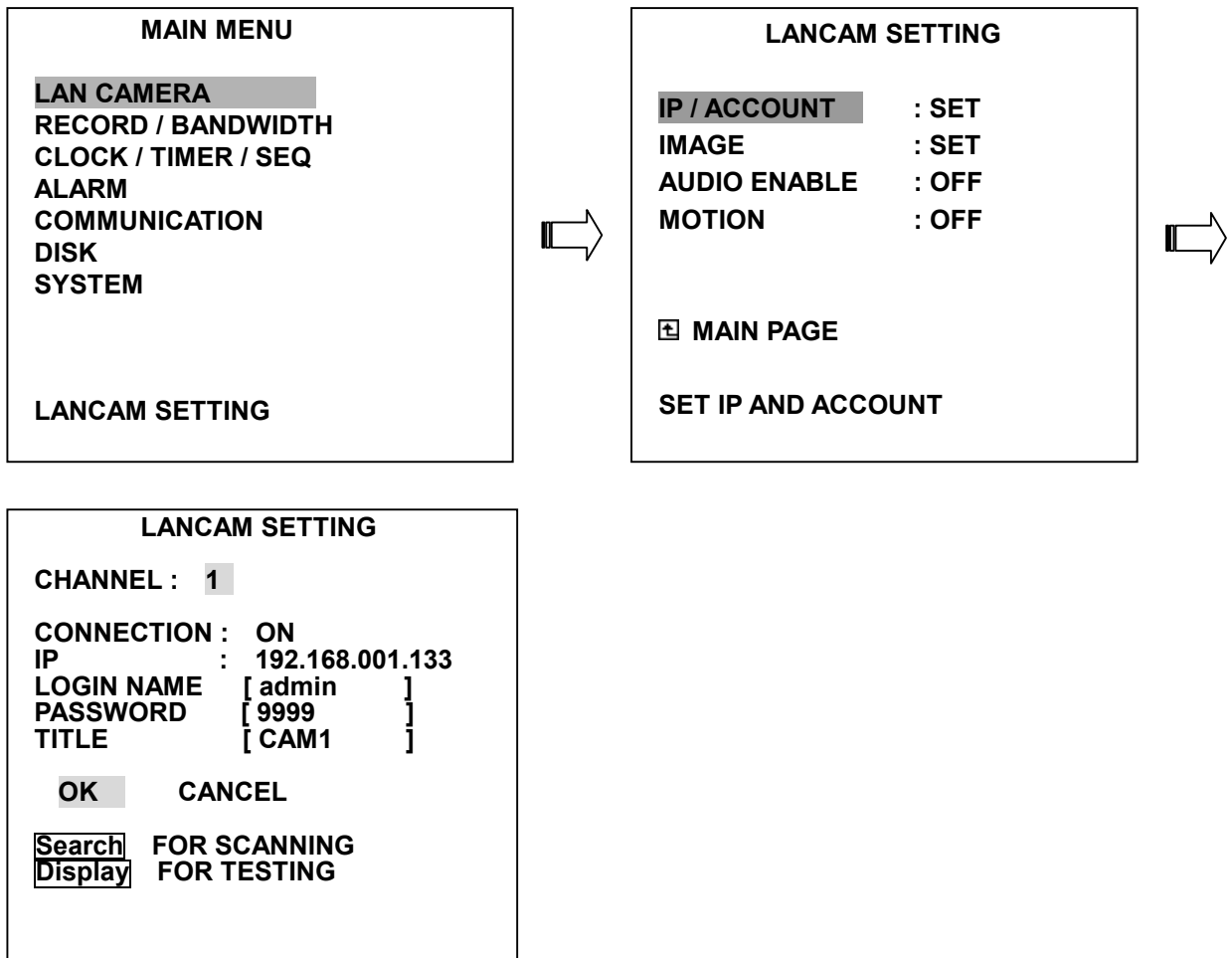
Turn to highlight the desired option or to select the context for setting.

**Jog Dial** ㉑ :

Turn to select the desired item or entry for setting.

## 5.1 LAN CAMERA SETTING

This page allows you can select your desired LAN Camera, whose images you can save in the NVR hard disk. The login name and password must be entered correctly.



### IP / ACCOUNT:

Set the desired channel, entering its number (1 to 8) in the given space. Turn the “CONNECTION” to “ON”, Provide the corresponding “IP” address in the “IP” entry, because each LAN Camera has its own individual IP. Each IP is a camera, whose “**LOGIN NAME**” and “**PASSWORD**” must be entered correctly.

**NOTE:** Press the “**Search**” button **⑩** to activate “**SCANNING**” of all the LAN Cameras at disposal. The screen will display a partial list of cameras, from the desired camera’s IP can be selected. Push the Enter button **⑮** to automatically display the chosen IP of that camera.

**NOTE:** Press the “**Display**” button **⑧** to trigger the “**TESTING**” function. Immediately a picture appears on a screen at bottom right.

**MAIN MENU**

**LAN CAMERA**  
**RECORD / BANDWIDTH**  
**CLOCK / TIMER / SEQ**  
**ALARM**  
**COMMUNICATION**  
**DISK**  
**SYSTEM**

**LANCAM SETTING**



**LANCAM SETTING**

**IP / ACCOUNT : SET**  
**IMAGE : SET**  
**AUDIO ENABLE : OFF**  
**MOTION : OFF**

**MAIN PAGE**

**IMAGE SETTING**



**IMAGE SETTING**

**RESOLUTION : 352 X 240**  
**QUALITY : HIGHEST**

**LANCAM PAGE**

**SET IMAGE RESOLUTION**



**IMAGE SETTING**

**RESOLUTION : 352 X 240**  
**720 X 480**  
**SET**

**LANCAM PAGE**

**SET IMAGE RESOLUTION INDIVIDUALLY**



**IMAGE SETTING**

**QUALITY : HIGHEST**  
**HIGH**  
**MEDIUM**  
**LOW**  
**LOWEST**  
**SET**

**LANCAM PAGE**

**SET QUALITY TO HIGHEST FOR EACH CH**



**RESOLUTION SETTING**

<b>CH1</b>	<b>CH2</b>	<b>CH3</b>	<b>CH4</b>
<b>352 X 240</b>	<b>352 X 240</b>	<b>352 X 240</b>	<b>352 X 240</b>
<b>CH5</b>	<b>CH6</b>	<b>CH7</b>	<b>CH8</b>
<b>352 X 240</b>	<b>352 X 240</b>	<b>352 X 240</b>	<b>352 X 240</b>

**OK CANCEL**

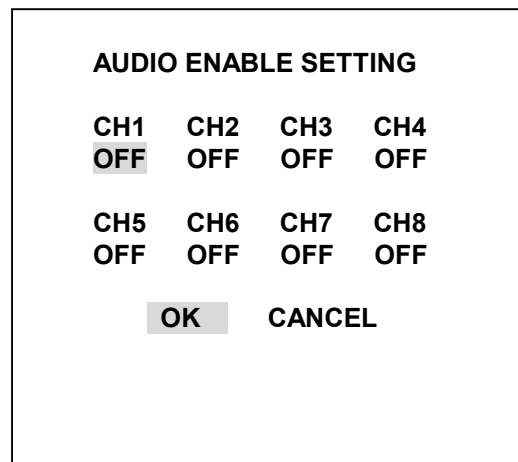
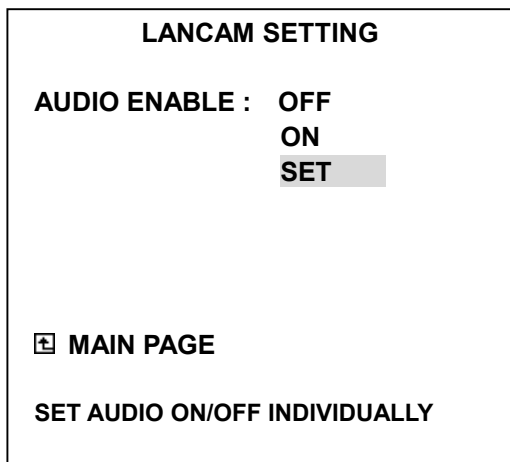
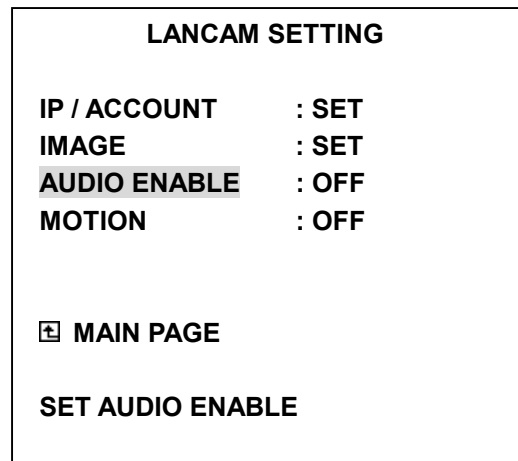
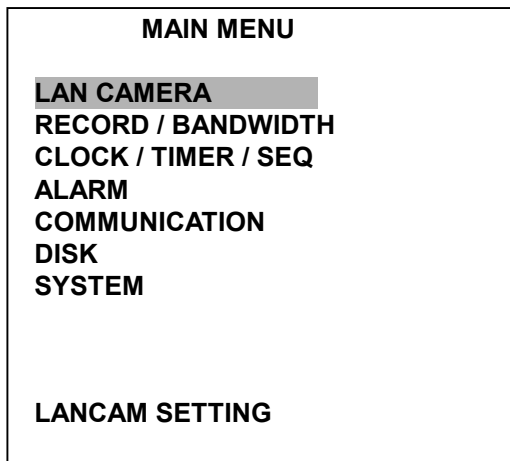
**QUALITY SETTING**

<b>CH1</b>	<b>CH2</b>	<b>CH3</b>	<b>CH4</b>
<b>HIGHEST</b>	<b>HIGHEST</b>	<b>HIGHEST</b>	<b>HIGHEST</b>
<b>CH5</b>	<b>CH6</b>	<b>CH7</b>	<b>CH8</b>
<b>HIGHEST</b>	<b>HIGHEST</b>	<b>HIGHEST</b>	<b>HIGHEST</b>

**OK CANCEL**

## IMAGE:

- (1) Press the **Setup** button ⑨ to enter the **MAIN MENU**.
- (2) Select the item termed "**LAN CAMERA**" and press the **Enter** button ⑮ to enter the **LANCAM SETTING** page.
- (3) Select the item termed "**IMAGE**" and push the **Enter** button ⑮ to enter the **IMAGE SETTING** page.
- (4) To regulate the image resolution function, set the "**RESOLUTION**" either to "**352 x 240**", or to "**720 x 480**". In either case, all channels will convert to your desired mode. If, however, you wish to set individual channels in different modes, please select "**SET**" for this function. After set individual channels in different modes and then push the **Enter** button ⑮. At once the legends "**OK**" and "**CANCEL**" appear at the bottom of the page. Now press the "<" button ⑪ and the ">" button ⑭ to confirm either "**OK**" or "**CANCEL**" respectively. Press "**OK**" to ratify your choice(s). If not, press "**CANCEL**".
- (5) To regulate image quality, you can use the "▲" button ⑫ and the "▼" button ⑬ to select any of the five levels of quality provided here, ranging from the "**HIGHEST**" to the "**LOWEST**". If you select any of these levels, all your channels will convert to that level. If, however, you wish to set individual channels in different levels of quality, please got to "**SET**" for this function. After set individual channels in different modes and then push the **Enter** button ⑮. At once the legends "**OK**" and "**CANCEL**" appear at the bottom of the page. Now press the "<" button ⑪ and the ">" button ⑭ to confirm either "**OK**" or "**CANCEL**" respectively. Press "**OK**" to ratify your choice(s). If not, press "**CANCEL**".



#### AUDIO ENABLE:

- (1) Press the **Setup** button **9** to enter the **MAIN MENU**.
- (2) Select the item termed "**LAN CAMERA**" and press the **Enter** button **15** to enter the **LANCAM SETTING** page.
- (3) Select the item termed "**AUDIO ENABLE**" and push the **Enter** button **15** to select the **AUDIO ENABLE**.
- (4) To activate the motion detection function, set "**AUDIO ENABLE**" to "**ON**". To deactivate the function, set "**AUDIO ENABLE**" to "**OFF**". The items termed "**OFF**" and "**ON**" switch all the channels in the **AUDIO ENABLE SETTING** page off and on respectively as well. If you wish to select individual channels for sounds, select the item termed "**SET**" and activates your desired channels by pressing them "**ON**" while turning the rest "**OFF**". After set individual channels in different modes and then push the **Enter** button **15**. At once the legends "**OK**" and "**CANCEL**" appear at the bottom of the page. Now press the "**<**" button **11** and the "**>**" button **14** to confirm either "**OK**" or "**CANCEL**" respectively. Press "**OK**" to ratify your choice(s). If not, press "**CANCEL**".

**MAIN MENU**

LAN CAMERA  
 RECORD / BANDWIDTH  
 CLOCK / TIMER / SEQ  
 ALARM  
 COMMUNICATION  
 DISK  
 SYSTEM

LANCAM SETTING

**LANCAM SETTING**

IP/ACCOUNT : SET  
 IMAGE : SET  
 AUDIO ENABLE : OFF  
 MOTION : SET

MAIN PAGE

MOTION SETTING



**MOTION SETTING**

MOTION ENABLE : ON  
 SENSITIVITY/REGION : CH1

LANCAM PAGE

SET MOTION ENABLE

**MOTION SETTING**

MOTION ENABLE : ON  
 SENSITIVITY/REGION : CH1

LANCAM PAGE

SET MOTION SENSITIVITY/REGION



**MOTION SETTING**

MOTION ENABLE : OFF  
 ON  
 SET

LANCAM PAGE

SET MOTION ENABLE

**MOTION SETTING**

MOTION ENABLE  
 SENSITIVITY/REGION : CH1  
 CH2  
 CH3  
 CH4  
 CH5  
 CH6  
 CH7  
 CH8

LANCAM PAGE

SET MOTION OF CH5




**MOTION ENABLE SETTING**

CH1	CH2	CH3	CH4
ON	ON	ON	ON
CH5	CH6	CH7	CH8
ON	ON	ON	ON

OK CANCEL

**SENSITIVITY / REGION SETTING**

SENSITIVITY HIGHEST  
 REGION ( 30, 25 ) - ( 90, 70 )

OK CANCEL 



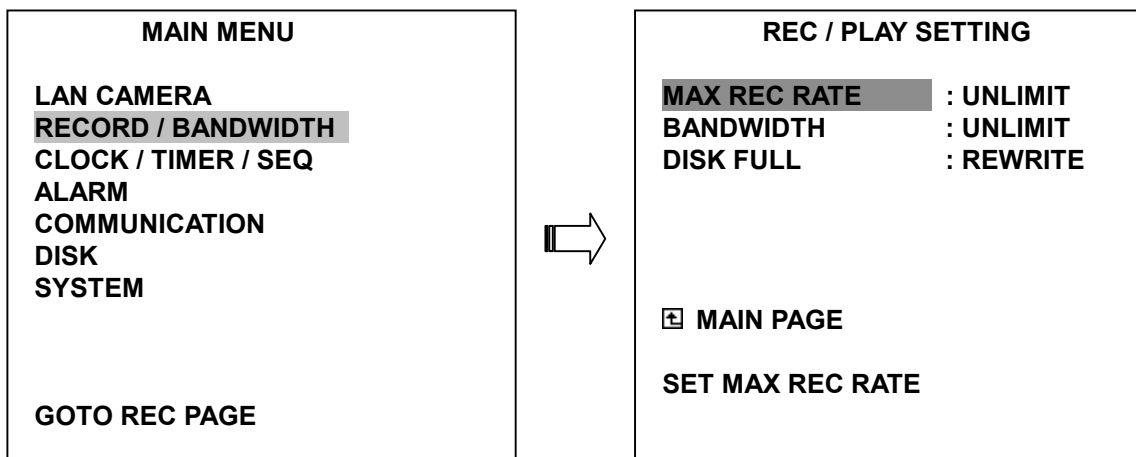
## MOTION:

Take the steps detailed below to activate a programmed motion detection. For **MOTION SETTING**, as well as its two distinct functions of **MOTION ENABLE** and **SENSITIVITY / REGION**.

- (1) Press the **Setup** button ⑨ to enter the **MAIN MENU**.
- (2) Select the item termed "**LAN CAMERA**" and press the **Enter** button ⑮ to enter the **LANCAM SETTING** page.
- (3) Select the item termed "**MOTION**" and push the **Enter** button ⑮ to enter the **MOTION SETTING** page.
- (4) To activate the motion detection function, set "**MOTION ENABLE**" to "**ON**". To deactivate the function, set "**MOTION ENABLE**" to "**OFF**". The items termed "**OFF**" and "**ON**" switch all the channels in the **MOTION ENABLE SETTING** page off and on respectively as well. If you wish to select individual channels for viewing, select the item termed "**SET**" and activates your desired channels by pressing them "**ON**" while turning the rest "**OFF**". Confirm your choices by pressing "**OK**". If not, push "**CANCEL**".
- (5) In the **MOTION SETTING** page, select the entry termed "**SENSITIVITY / REGION**" and press the ">" button ⑭ to show all the channels in their order, each in turn. Use the "▲" button ⑫ and the "▼" button ⑬ to select a desired channel for setting. Press the **Enter** button ⑮ and set the channel in the **SENSITIVITY / REGION SETTING** page. Repeat the process for all other channels you choose.
- (6) To set "**SENSITIVITY**" and "**REGION**" for activation on the **SENSITIVITY / REGION** page, choose your degree of sensitivity and then push the **Enter** button ⑮. At once the legends "**OK**" and "**CANCEL**" appear at the bottom of the page. Now press the "<" button ⑪ and the ">" button ⑭ to confirm either "**OK**" or "**CANCEL**" respectively.

## 5.2 REC SETTING

This page allows you to set the recording rate and recording quality, and enables you to continue recording when the disk is full.



**MAX REC RATE:**

This option is used for limiting the number of pictures recorded every second into a storage disk. The recording rate controls the maximum of the frequency at which the number of video pictures can be recorded.

- There are 4 different recording rates you can select from: **UNLIMIT**, **30F/S**, **20F/S**, and **10F/S**.

**NOTE: The maximum of pictures is averagely shared among all channels.**

**BANDWIDTH:**

This option determines the bandwidth to be recorded. There are seven levels of bandwidth you can select from: **50K**, **100K**, **200K**, **300K**, **400K**, **500K**, and **UNLIMIT**. Selecting the **UNLIMIT** for use provides bandwidth unlimited for each channel recorded images, and normally records more images than a 50K, 100K, 200K, 300K, 400K and 500K. To regulate bandwidth, you can use the “**▲**” button **12** and the “**v**” button **13** to select any of the seven levels of bandwidth provided here, ranging from the “**UNLIMIT**” to the “**50K**”. If you select any of these levels, all your channels will convert to that level. If, however, you wish to set individual channels in different levels of bandwidth, please got to “**SET**” for this function. After set individual channels in different modes and then push the **Enter** button **15**. At once the legends “**OK**” and “**CANCEL**” appear at the bottom of the page. Now press the “**<**” button **11** and the “**>**” button **14** to confirm either “**OK**” or “**CANCEL**” respectively. Press “**OK**” to ratify your choice(s). If not, press “**CANCEL**”.

**DISK FULL:**

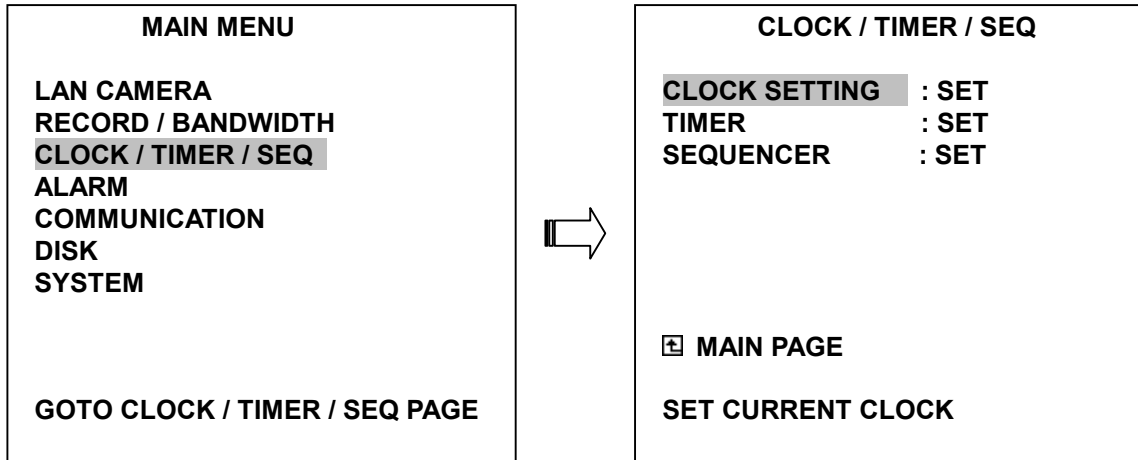
This option determines the way to utilize storage media in case of a full disk.

**REWRITE:** When the hard-disk is full, the device continues recording by displacing the old data.

**STOP:** When the hard-disk is full, the device will stop recording.

### 5.3 CLOCK / TIMER / SEQ SETTING

The NVR provides a weekly table, consisting of two periods of time each day for scheduled recording. This option allows you to set the time each day that the NVR will start and stop recording.



#### CLOCK SETTING:

This entry allows users to set the system time.

**NOTE:** Clock data is retained for about 3 months after the 15-hour power supply is used up (Operate On mode).

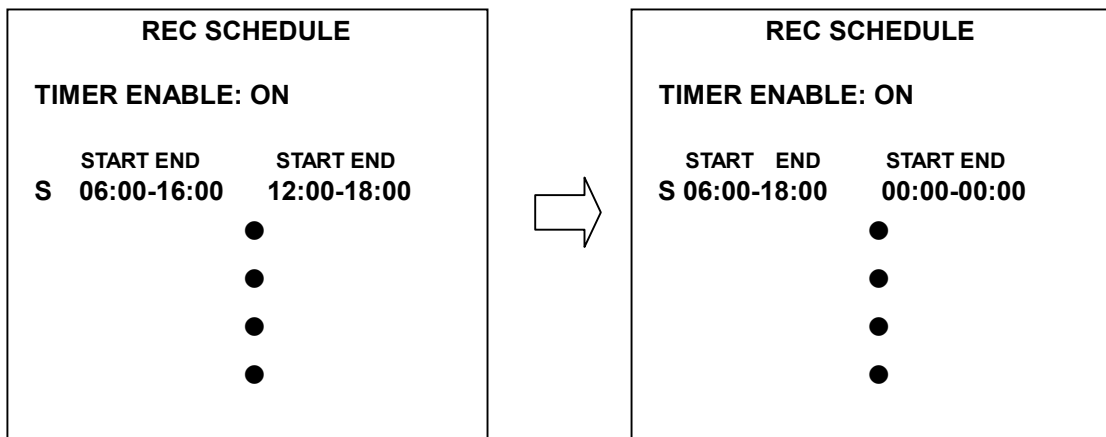
#### TIMER:

This entry allows users to program the time each day that the NVR will start and stop recording. There are two time periods each day available for scheduling. The time is displayed in a 24-hour clock format. If there is a time overlapping showing between two continual time period settings, the device will automatically combine the two time-period settings into one combined time-period setting.

**TIMER ENABLE:** This option enables/disables the programmed scheduled recording.

**ON:** Enables the scheduled recording.

**OFF:** Disables the scheduled recording.

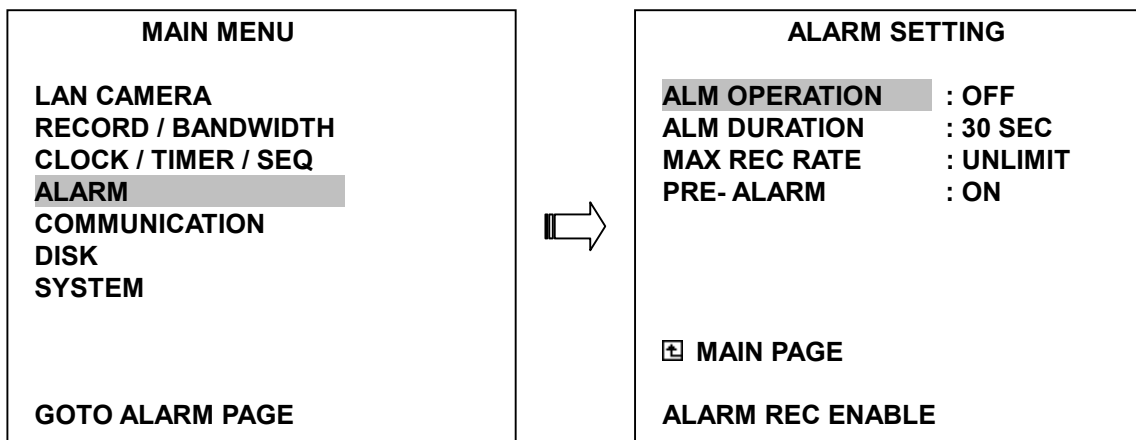


## SEQUENCER:

To regulate dwell time of the sequencer, you can use the “^” button ⑫ and the “v” button ⑬ to select dwell time provided here, ranging from the “00” to the “30”.you can set individual channels in different dwell time. After set individual channels, quad and multi screen in different modes and then push the **Enter** button ⑮. At once the legends “OK” and “CANCEL” appear at the bottom of the page. Now press the “<” button ⑪ and the “>” button ⑭ to confirm either “OK” or “CANCEL” respectively. Press “OK” to ratify your choice(s). If not, press “CANCEL”.

## 5.4 ALARM SETTING

This menu allows users to program the configuration of alarm recording only when an alarm input is activated. The device will record as long as the alarm input is activated.



### ALM OPERATION:

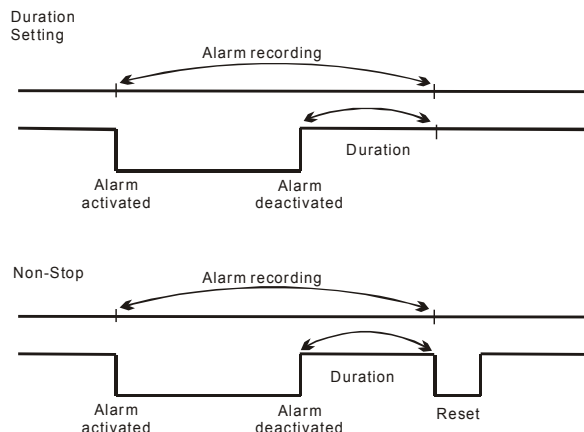
This option determines whether to activate/deactivate the alarm recording when it detects an alarm input.

**ON:** The device activates the alarm recording when it detects an alarm signal from LANCAM.

**OFF:** The device ignores the alarm signal when it detects an alarm signal from LANCAM.

### ALM DURATION:

This option allows users to set alarms for a certain duration. You can select one of the six following options: **0 SEC**, **30SEC**, **1 MIN**, **5 MIN**, **10 MIN**, and **NON-STOP**.



**MAX REC RATE:**

This option is the number of pictures recorded every second into a storage disk when an alarm input is activated. There are 2 different record speeds you can select **UNLIMIT** or **REMAIN**. If you select **REMAIN** for use, the device will record images at the same speed as set on the **REC** page.

**PRE- ALARM:**

This option determines that images prior to an alarm occurs will be recorded in the hard-disk drive. When an alarm is triggered the device will record the image prior to the alarm for up to 256 images.

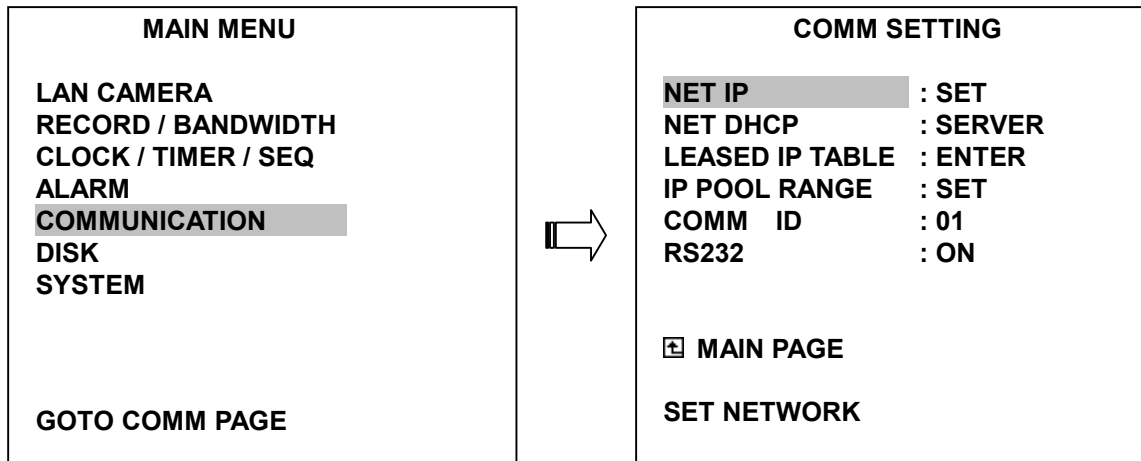
**ON:** Enables this function.

**OFF:** Disables this function.

**NOTE: If the device is already under recording mode before alarm occur, the pre-alarm recording would not take effect.**

## 5.5 COMMUNICATION

This option allows you to configure the status of the RS-232 communication port when connected to an external device, and the Ethernet communications settings. (Please refer to the RS-232 Protocol and Network Function for more details)



### NET IP:

This option is used to configure the Ethernet communication settings. This is required for the purpose of making a network connection. Please consult with a qualified MIS professional to configure it.

**IP:** XXX.YYY.ZZZ.WWW

**MASK:** XXX.XXX.XXX.XXX

**GATEWAY:** XXX.XXX.XXX.XXX

### NET DHCP:

This option selects CLIENT, SERVER or OFF for the DHCP communication function.

**OFF:** Disables it.

**CLIENT:** Disables it.

**SERVER:** Enables it.

**NOTE:** The range of available IP to be leased by DHCP server is from XXX.YYY.ZZZ.1 to XXX.YYY.ZZZ.254 except for NVR's IP XXX.YYY.ZZZ.WWW.

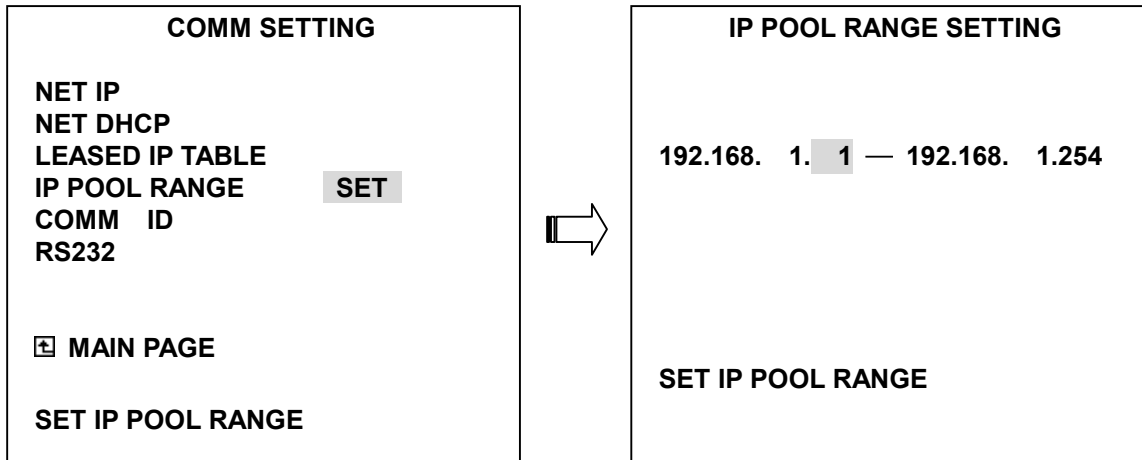
**NOTE:** If provided with a DHCP server, the NVR-2018 can get an IP automatically by setting this option to CLIENT.

### LEASED IP TABLE:

Show DHCP leased IP table.

### IP POOL RANGE:

You can set your DHCP IP address by changing only the last part of the four - part IP address given below. The last part can be any number selected from a range between 1 and 254.



### COMM ID:

Communication ID for RS232 communication. After the NVR-2018 receives a RS232 command, it checks if the <Dest ID> within the code is the same as the COMM ID, in which case the particular command can be accept.

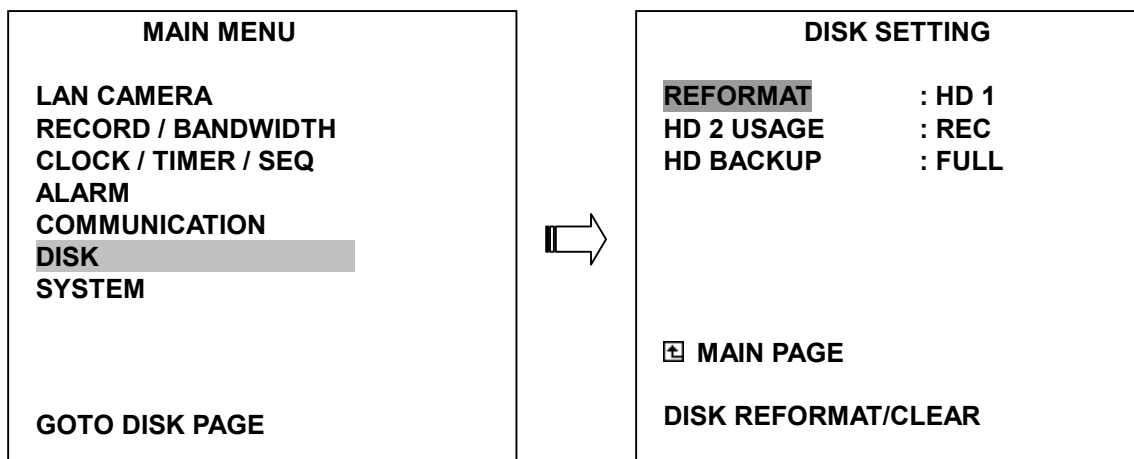
### RS-232:

The RS-232 communication port can be either in an importing or exporting mode according to your applications.

**ON:** Enables the RS-232 communication port. When you wish the unit to be controlled by an external device, please select this entry for use.

**OFF:** Disables the RS-232 communication port.

## 5.6 DISK SETTING



### REFORMAT:

This option allows you to clear out all the data in the hard-disk drive. You will be required to enter the pre-set password before proceeding with clearing out the data. Enter the standard password “9999” if you don’t set your individual password. To set your individual password, please refer to section 5.7

**PASSWORD** option.

**HD 1 :** Clears out all the data stored in HD 1 and HD 2.

**BACKUP HD:** Clears out all the data stored in HD 2, which is set to backup purpose only. (This function has to be proceeded with when the **HD 2 USAGE** option is set to **BACKUP**.)

### HD2 USAGE:

This option determines the way to utilize the hard-disk drive in the mobile compartment.

**BACKUP:** Used for data backup only, which will not be part of regular recording hard-disk drive.

**REC:** Used for the regular recording hard-disk drive.

**NOTE:** When you wish to play back a recorded video from a HD2, this option must be set to **REC**. For more details, please refer to section 4.3.4.

### HD BACKUP:

This function allows you to duplicate data from HD 1 to HD 2. Please set HD 2 as **BACKUP** first. (For operation details, please refer to section 4.5.1)

**FULL:** Duplicates all the recorded video from HD1 to HD2.

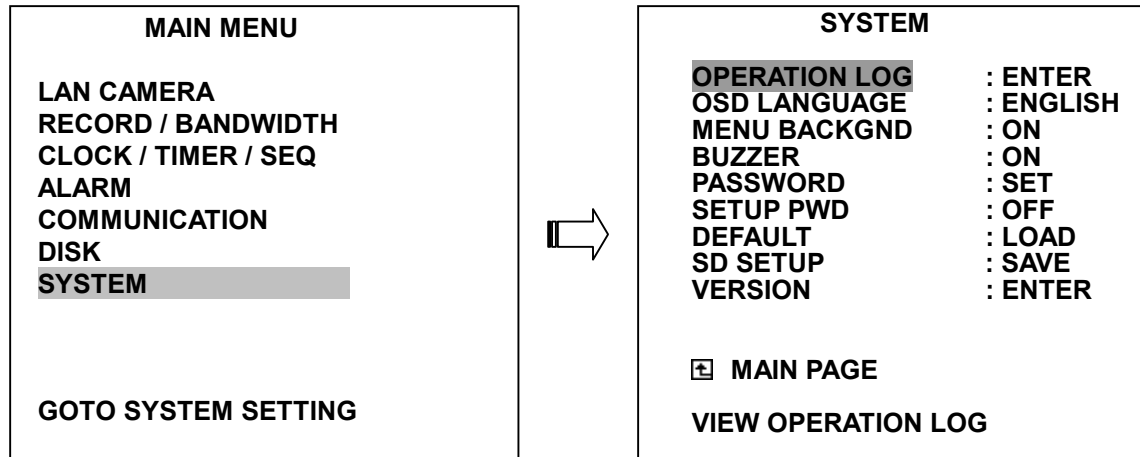
**ALARM:** Duplicates all the alarm-event recorded video from HD 1 to HD2

**SELECT:** Duplicates a particular recorded video from HD1 to HD2.



## 5.7 SYSTEM SETTING

This page is used for accessing the history of the operation status, setting the password, resuming factory default, and determining the menu display background.



### OPERATION LOG:

This log shows the history of the operation status in chronological order. What the following entries represent is detailed below.

- ON:** Powers up the device.
- OFF:** Powers off the device.
- REC:** Starts recording.
- STOP:** Ceases recording.
- PLAY:** Shows recorded video.
- P-LOSS:** Power interruption occurs.
- A-IN:** Detects an alarm input.
- LOCK:** Disables the entire front panel controls.
- UNLOCK:** Releases the key lock.
- UPDATE:** Updates system software.
- M-IN 1:** Detects a motion input in channel 1.
- M-OUT 1:** Detects a motion stop in channel 1.
- C-BRK 1:** Connector interruption occurs in channel 1.

05/15/03	18:19:32	ON
05/15/03	18:19:32	OFF
05/15/03	18:19:32	REC
05/15/03	18:19:32	STOP
05/15/03	18:19:32	PLAY
05/15/03	18:19:32	M-IN 1
05/15/03	18:19:32	C-BRK 1
05/15/03	18:19:32	P-LOSS

**Note:** The log keeps an operation history on a revolving basis because of a limit is 4000. When the log is full, the newly registered record of an operation will replace the existing records

from the oldest one.

**OSD LANGUAGE:**

This option allows you to select the OSD language display as English, or Chinese.

**MENU BACKGND:**

There are 3 levels of background color transparency, you can choose from : level 1 is totally transparent, level 3 is opaque, and level 2 is between level 1 and 3. The background color is used in setup menu and search function.

**BUZZER:**

This option determines the embedded buzzer sounding a tone to signal the following situations. A tone lasts about two seconds long.

- ON:** Enables buzzer.
- OFF:** Disables buzzer.

---

<b>Situation</b>
Alarm occurs
Video loss occurs
Disk is full
Load factory default
Buzzer set to ON
Enable/disable key lock function
Power on /off mobile rack HDD
Backup operation complete
Timer activate/deactivate
Recording switching between HDD

---

**PASSWORD:**

This option allows you to set a password to prevent any unauthorized re-formatting of the hard disk drives or use by a network viewer. The standard password is "9999".

**OLD PASSWORD:** Enter the pre-set password (or the standard password if this is the initial setting) to access the password setting system.

**NEW PASSWORD:** Enter a 4-digit-number password of your choosing which will replace the pre-set password (or the standard password "9999").

**SETUP PWD:**

When this option is on, user must pass the password check before entering the setup menu.

- ON:** Enables it.
- OFF:** Disables it.

**DEFAULT:**

This option allows you to reload the factory default setting. Please do note that the password can not be changed in the factory default setting.

**SD SETUP:**

The NVR-2018 offers a quick setup method by using a SD card. If the user wants to set up many a number of the same devices with the same settings, he can save the whole settings to a SD card, then transfer to another NVR.

**SAVE:** Saves the whole setting to the SD card.

**LOAD:** Loads the whole setting to the SD card.

**VERSION:**

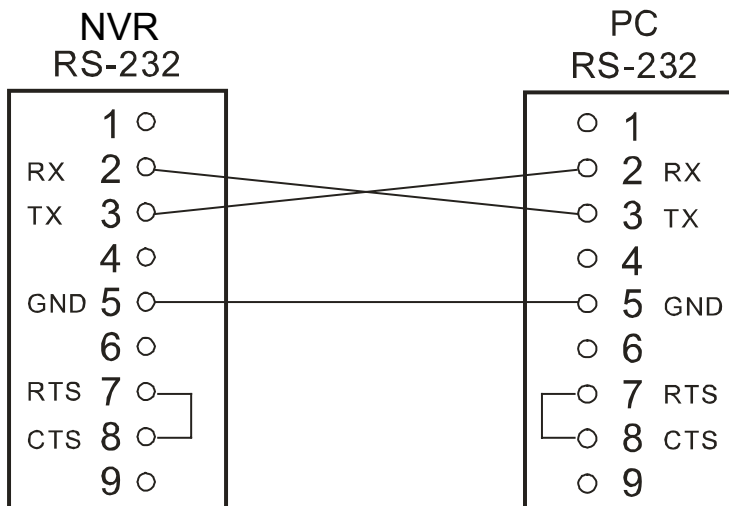
This item is in the setup menu reveal network MAC, BIOS version, and software version, and last updated date.

```
MAC   : 00 : 0c : 0c : 00 : 00 : 07
BIOS  : 1.03
S/W   : 0.35
DATE  : Dec 24 2003
```

## 6. RS-232 Protocol

### 6.1 Setup

6.1.1 Use a Null Modem cable (the standard RS-232 9 Pin Cable with Pin 2 and Pin 3 exchanged, see pin configuration chart below for details) to connect the COM 1 on the rear panel of the NVR to a PC.



6.1.2 Set the **RS-232** option to **ON** in the **COMMUNICATION** page of the setup menu.

6.1.3 Set the PC communication parameters: 9600 bps, No Parity, 8 Data Bits, 1 Stop Bit.

### 6.2 Communication Protocol

#### 6.2.0 General Command Format

<Lead Code = 0x41>, < Dest ID >, < Src ID >, <Main category >, <Second category >, {<Number of parameters>,<Parameter 1>, <Parameter 2> ...} <End Code= 0x4f>

Lead Code = 0x41

Dest ID = 0x01

Src ID = 0x20

Main Category = 0x01 Keys and Signals

= 0x02 Command

Second Category = 0x01 Handshake

= 0x02 Request Time/Set Time

= 0x06 Request System State

= 0x0b Time Search

End Code= 0x4f

**The different command types and their corresponding parameters are as follows:**

#### 6.2.1 Keys and signals

PC Send: <0x41>, <0x01>, <0x20>, <0x01>, <Key Value(Low byte)>,  
<Key Value(High byte)>,<0x4f>

**< The value of a specific front panel key >**

KEY_PLAY	1
KEY_STOP	3
KEY_PAUSE	4
KEY_POWER	5
KEY_REC	6
KEY_SETUP	7
KEY_ENTER	8
KEY_SEARCH	10
KEY_DISPLAY	11
KEY_UP	13
KEY_DOWN	14
KEY_LEFT	15
KEY_RIGHT	16
KEY_SHIFT	36
JOG_L	128
JOG_R	129
KEY_SHIFT_LEFT	140
KEY_SHIFT_RIGHT	141
KEY_SHIFT_DOWN	142
KEY_SHIFT_UP	143
KEY_SHIFT_ENTER	144
KEY_SHIFT_DISPLAY	145
KEY_SHIFT_SEARCH	146
KEY_SHIFT_SETUP	147
KEY_SHIFT_POWER	148
KEY_SHIFT_PLAY	149
KEY_SHIFT_PAUSE	150
KEY_SHIFT_REC	151
KEY_SHIFT_STOP	152
KEY_SHUT_L8	160
KEY_SHUT_L7	161
KEY_SHUT_L6	162
KEY_SHUT_L5	163
KEY_SHUT_L4	164
KEY_SHUT_L3	165
KEY_SHUT_L2	166
KEY_SHUT_L1	167
KEY_SHUT_CT	168
KEY_SHUT_R1	169
KEY_SHUT_R2	160
KEY_SHUT_R3	161
KEY_SHUT_R4	162
KEY_SHUT_R5	163
KEY_SHUT_R6	164
KEY_SHUT_R7	165
SIGNAL_POWER	256
SIGNAL_REC_IN	257
SIGNAL_REC_OUT	258

**6.2.2 COMMAND Types**

**6.2.2.0 Command (Main Category=0x02)**

**6.2.2.1 Handshake (Second Category=0x01)**

PC Request: <0x41>, <0x01>, <0x20>, <0x02>, <0x01>, <0x00>, <0x4f>

NVR Response: <0x41>, <0x20>, <0x01>, <0x02>, <0x08>, <0x00>, <0x4f>

### 6.2.2.2 Request Time (Second Category=0x02)

PC Request: <0x41>, <0x01>, <0x20>, <0x02>, <0x02>, <0x00>, <0x4f>

NVR Response: <0x41>, <0x20>, <0x01>, <0x02>, <0x02>, <0x07>, <7 Time Value >, <0x4f>

The following case is an illustration of < 7 Time Value>

2001/06/20 17:05:00 = <0xD1>, <0x07>, <0x06>, <0x14>, <0x11>, <0x05>, <0x00>

### 6.2.2.3 Set Time (Second Category=0x02)

PC Request: <0x41>, <0x01>, <0x20>, <0x02>, <0x02>, <0x07>, < 7 Time Value >, <0x4f>

The following case is an illustration of < 7 Time Value>

2001/06/20 17:05:00 = <0xD1>, <0x07>, <0x06>, <0x14>, <0x11>, <0x05>, <0x00>

NVR Act: Changing the time and date.

### 6.2.2.4 Request State (Second Category=0x06)

PC Request: <0x41>, <0x01>, <0x20>, <0x02>, <0x06>, <0x00>, <0x4f>

NVR Response: <0x41>, <0x20>, <0x01>, <0x02>, <0x06>, <0x01>,

<System State = 0..>, <0x4f>

**Description of <System State>:**

STATE_INIT	0
STATE_LIVE	1
STATE_REC	2
STATE_PLAY	3
S_STATE_PAUSE	4
STATE_NET_PLAY	5
STATE_NET_PAUSE	6
STATE_RESTART	7
STATE_SETUP	8,9
STATE_MENU	10,11,12,13,14,15
STATE_DHCP_WAIT	16
STATE_SEARCH	17
STATE_BACKUP	18,19

### 6.2.2.5 Time Search (Second Category=0x0b)

PC send: <0x41>, <0x01>, <0x20>, <0x02>, <0x0b>, <0x06>, <6 Bytes Date/Time>, <0x4f>

where < 6 bytes Date/Time >, = year(2 bytes, =LowByte + HighByte\*256), month ( 1 byte), day (1 byte), hour(1 byte),min(1 byte)

Example: to search 06/12/2002 17:00 the Date/Time =

<0xd2>,<0x07><0x06>,<0x0b>,<0x11>,<0x00> where 2003= 210(=0xd3) + 7(=0x07) \*256

**NOTE: The NVR accepts RS-232 time search commands only under the live or playback Mode.**

## 7. IDE Hard Disk Installation

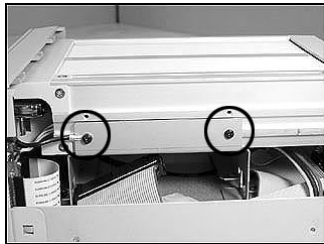
Usually, the unit comes with one hard-disk drive installed in compartment HD 1, which is default-configured as a master. The jumper settings configuration of the installed hard-disk drives for the unit and compatible drives which can be used with this unit are listed in the table below. To install two hard disk drives in compartment HD 1 and HD 2, please take the following steps.

**The jumper settings of hard-disk drives for the system**

	Location	Jumper
IDE 1	Compartment HD 1	Master
IDE 2	Compartment HD 2	Master

### 7.1 Built-in hard disk

1.

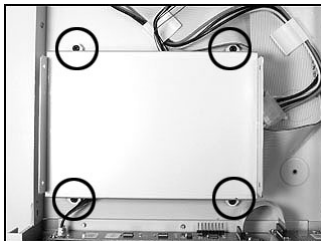


1. Unscrew all the mounting screws on the mobile rack of the unit and detach it.

2.



3.



2. Carefully lift the mobile rack to a vertical position.

3. Unscrew the secured screws to detach the hard disk rack.

4.



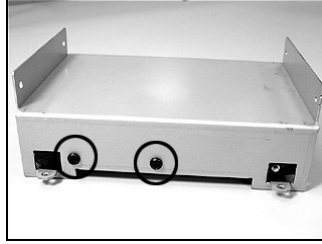
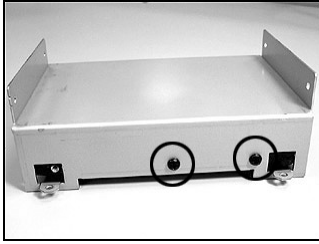
5.



4. Setting the jumper of your hard disk driver. The way to set the jumper of the drive varies between manufacturers; please refer to the instructions on the driver to set the jumpers in the master position.

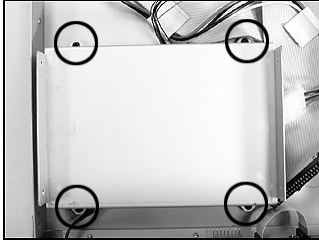
5. Place the hard disk in the rack.

6.

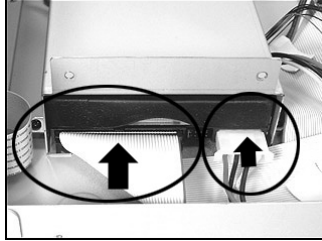


6. Secure the driver in the rack using two mounting screws in both the side-mounting holes. Please don't tighten the screws too much, otherwise that may damage the driver.

7.



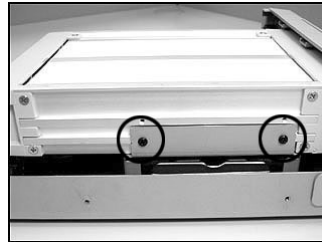
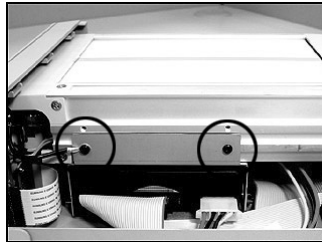
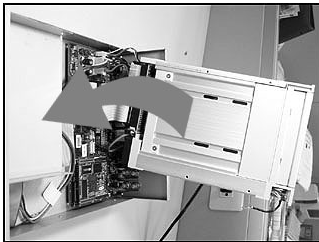
8.



7. Screw the rack into the device, screwing in all the four screws.

8. Attach the interface connector and the power connector to the drive. Please note the red lining of the IDE cable and the red wire of power cable must line up side by side.

10.



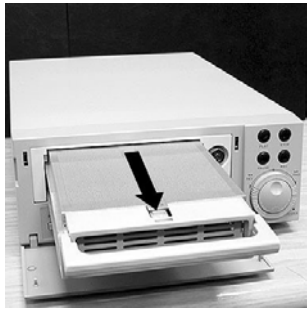
Place the mobile rack back onto the device and screw it in.

## 7.2 Mobile Rack

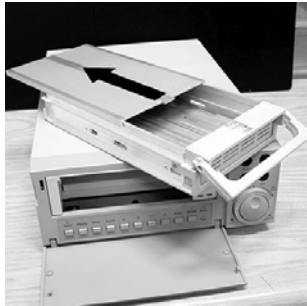


1. Make sure that the key is unlocked.





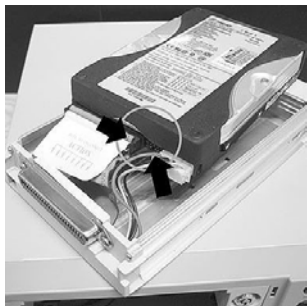
2. Pull the active-handle outward to remove the carrier body away from the mobile rack



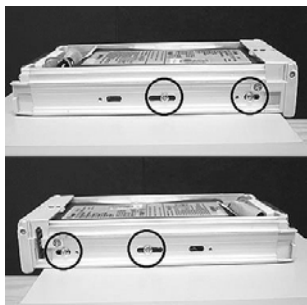
3. Slide the top cover backward and remove.



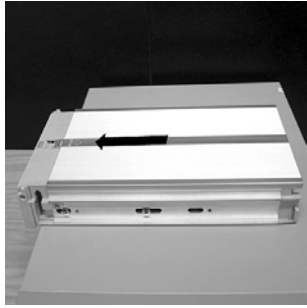
4. Setting the jumper of your hard disk driver. The way to set the jumper of the drive varies between manufacturers; please refer to the instructions on the driver to set the jumpers in the master position.



5. Attach the interface connector and the power connector to the drive. Please note the red lining of the IDE cable and the red wire of power cable must line up side by side.



6. Place the HDD inside mobile rack, Use four of the provided screws.
-



7. Place the top cover back to the carrier body by sliding forward to secure.



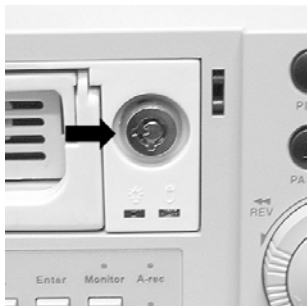
8. Slide the carrier body back in the mobile rack.



9. Push the carrier body further into the mobile rack until fully inserted.



10. Push the active-handle inward.



11. Lock the Key.

---

## 8. O.S.D Message

No.	O.S.D Message	Meanings
1	NO DISK	No hard-disk detected after power activated
2	BATTERY LOW	Suggest change the battery and reset the system time
3	LOADING	System Boot up
4	KEY LOCKED	Key lock function is on
5	KEY UNLOCKED	Key lock function is off
6	n1 OF n2 ITEMS PROGRESS n3 %	BACKUP n1/n2 NOW
7	BACKUP COMPLETE	Backup complete
8	HD2 SPACE NOT ENOUGH	HD2 has not enough space for backup
9	NO ENTRY FOR BACKUP	No backup is possible.
10	BACKUP INCOMPLETE	Backup incomplete, since the user has pressed the STOP button to stop it
11	NOT FOUND	The system cannot find a video in the Search function.
12	END	Playback of recorded video has reached the end point
13	DISK FULL	Hard-disks are full; this happens only when the DISK FULL item in the setup menu is set to STOP.
14	EMPTY	The user presses the PLAY button or uses the SEARCH function, but no video can be played.
15	SET TO NTSC, PLS RESTART	System has to be set to NTSC, please reboot (PAL is similar)
16	SOFTWARE UPDATE	Software update
17	PLEASE RESTART	The system should be rebooted after the software has been updated
18	NO DISK	The user has pressed the Save key without putting in a SD card, or there is a disk error.
19	DATA NOT CONTINUOUS	The system finds data in installed HDs cannot be used contiguously. Suggest you remove HD2 from the system.
20	DISK ATTACHED	HD2 has been attached.
21	DISK REMOVED	HD2 has been removed.
22	FAN STOPPED	The chassis fan has stopped for over 30 seconds.
23	HDn ERROR AT xxxxx	There is a hard-disk error during recording, where n is the hard-disk number and xxxxx is the hexadecimal location.
24	NOT PRESENT	When the user tries to clear a disk that was not attached in the setup menu.
25	SAVE TO DISK	Start saving to the JPEG file.
26	SAVE TO Fnnn. JPG	Save to Fnnn. JPG (where nnn= 0..999)
27	SAVE OK	Save to the JPEG is ok.
28	SD CARD WRITE PROTECT	A SD card is write-protected; or there is an error

## 9. Network Viewer and Image Viewer

This section provides instructions for installing and using the Network Viewer, and Image Viewer, which are included with the NVR. The programs can be operated by a selected PC equipped with the following requirements.

1. Intel Pentium 233MHz at least.
2. 32 MB RAM
3. Window 95, 98, NT, and ME.
4. 4 MB Video card capable of 24-bit true color display.
5. 5 MB free hard-disk space for software installation.
6. 10-base T network for LAN operation.

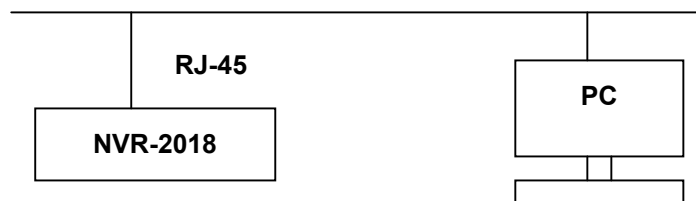
### 9.1 The Network Viewer

#### 9.1.1 Introduction to Network Viewer

The Network Viewer allows you to potentially access unit of the NVR from a remote desktop or a laptop in a TCP/IP networking environment. It can perform the following functions.

- View live images from the NVR
- Store, search, and review recorded video from the NVR HDD.
- Change the regular record, event record, and timer properties.

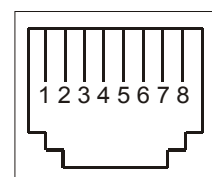
Before you are ready to view images from a desktop, you need to have your NVR networked by obtaining a 10 base Ethernet data cable (Standard RJ-45) to connect the NVR to your LAN/WAN. Now enter the main menu to set the IP address.



#### RJ-45 PIN configuration for Ethernet

PIN NO.	PIN Assignment
1.	TX +
2.	TX -
3.	RX +
4.	Not Connected
5.	Not Connected
6.	RX -
7.	Not Connected
8.	Not Connected

RJ-45 socket



### Physical specification for Ethernet

<b>Wire Type</b>	Cat. 5
<b>Connector Type</b>	RJ-45
<b>Max. Cable Length</b>	30 m
<b>Hub Wiring Configuration</b>	Straight Through
<b>PC Wiring Configuration</b>	Cross Over

**NOTE: For more details on network connections, please refer to the following document.**

#### 9.1.2 Install the Network Viewer in your PC

##### Install the Network Viewer from the supported CD-R.

1. Exit all applications currently running in the selected PC.
2. Insert the supported CD in the CD-ROM drive. The program will execute the installation automatically.  
Follow the on-screen instructions to proceed with the rest of the installation procedure as they appear.
3. After the installation is complete, pop up the **START** menu from your computer, and point to **Programs / APPRO NVR Network Viewer** to open up the program selection page as shown below. Click the **APPRO NVR Network Viewer** tag to start the **APPRO NVR Network Viewer** program.

##### Install the Network Viewer for the ZIP file.

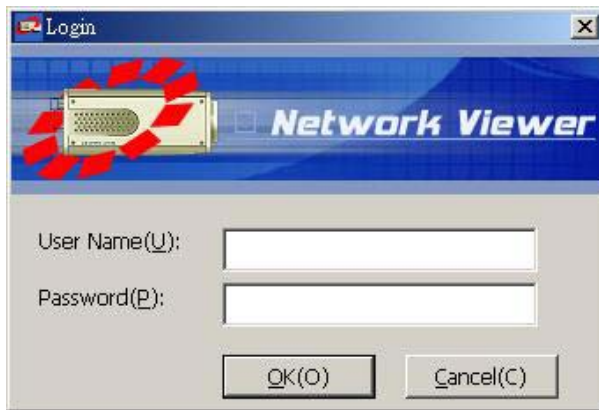
1. Save the ZIP file to your PC and extract the file to a designated directory.
2. Open the extracted folder.



3. Click on the **setup.exe** icon to execute the installation and then follow the on-screen instructions to proceed with the rest of the installation procedure as they appear.
4. After the installation is complete, pop up the **START** menu from your computer, and point to **Programs / APPRO NVR Network Viewer** to start the **APPRO NVR Network Viewer** program.

**NOTE: Please make sure the TCP/IP communication software has been properly set and configured in your computer. To check your TCP/IP settings, refer to the following document.**

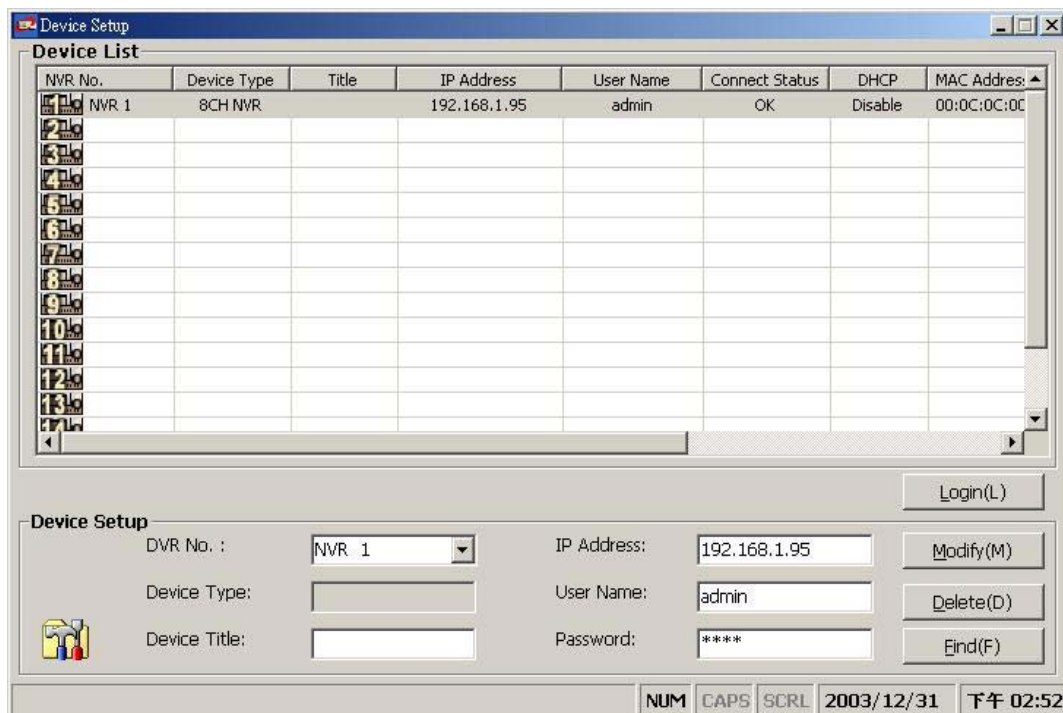
### 9.1.3 View the NVR video from a remote PC



Once Network View is executed a Login prompt will appear, you must enter the default User Name: **admin**, password: **9999** into the respective field and click on OK to log into the application.

Follow the instructions below to use the Network Viewer to browse a NVR video from a remote location. Upon entering the Network Viewer, the connection box will appear as follows.

1. Click the **Find** tag to connection of the all NVR device in the LAN.
2. Choose a channel number from the Channel drop-down list.
3. Type in the user name for the chosen NVR.
4. Type in the password of the device and click the **Modify** tag to add the device to the Device List.
5. Please repeat steps 2 to 4 again for another desire.
6. Select the NVR to enter this device.
7. Click the **Login** tag to begin viewing images.



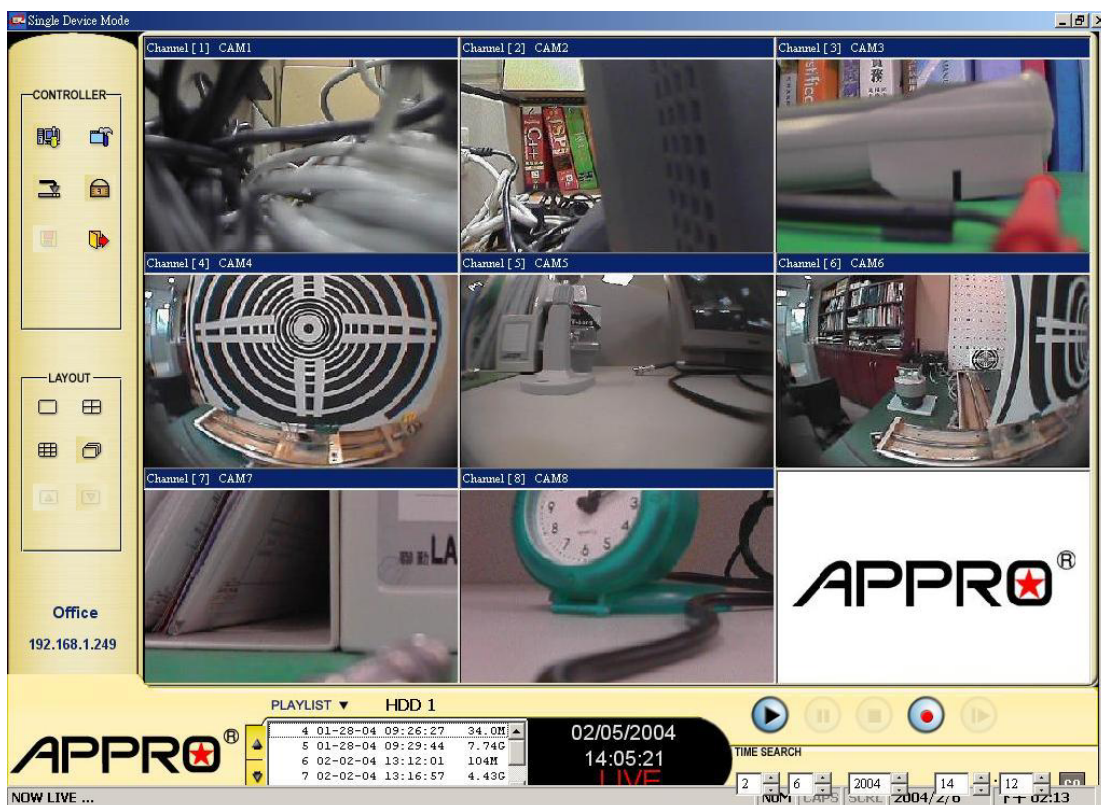
**NOTE:** Upon connection, the connection status box indicates the name and IP address of the selected device. If there's a failure to connect, a "Fail" message appears on the screen right after the device IP address; otherwise an "OK" appears. To add more connections or units to the NVR, please repeat the above instructions.


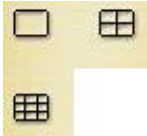












Functions	Description
● <b>Device List</b>	Displays the entire list of connected devices if and as necessary. This list includes a lot of information about all the connected devices.
● <b>NVR Number</b>	Assigns a display location when you have multiple devices connected.
● <b>Device Type</b>	Displays the device type.
● <b>Device Title</b>	This blank allows you to assign a label to the chosen device.
● <b>IP Address</b>	Type in the IP address which you preset for the device
● <b>User Name</b>	This space allows you to assign a name to the chosen device.
● <b>Password</b>	Type in the preset password for making a connection.
● <b>Add</b>	Click to add the settings of a chosen device.
● <b>Modify</b>	Click to change the settings of a chosen device.
● <b>Delete</b>	Click to remove the connection of a chosen device.
● <b>Find</b>	Click to find the connection of the all NVR device in the LAN.
● <b>Login</b>	Click to access the display page of the Network Viewer.

## Viewing images

### View the connected device

Once the connection has been established, click the **Login** tag to enter the single-device mode window. (See the sample screen below) This window displays the connected device in the sequence which has been arranged when you established the connection.



Function Buttons	Description
	<p>Playback function bar.</p> <ul style="list-style-type: none"> <li>● Play- Click to a recorded video from the PLAY LIST.</li> <li>● Pause- Click to freeze the image.</li> <li>● Stop- Click to stop playing back the recorded video or cease recording.</li> <li>● REC- Click to activate the recording function of the device.</li> <li>● Step- Click to view images picture-by-picture.</li> </ul>
	<p>The Split-Screen display function bar. This allows you to display the connected device in the multi-format screens of 1, 2x2 and 8.</p>
	<p>Press to enter the PC SYSTEM SETUP window, which allows you to program the System Setup, Record Setup, and Alarm Setup.</p>
	<p>Press to enter the LANCAM setting window, to open the device setting page to add more devices for viewing, Which allows you to program the Record Setting and Record Schedule.</p>
	<p>Click to minimize the Network Viewer into a PC system tray.</p>
	<p>Click to lock the system.</p>
	<p>Click to save a viewing image in the local computer.</p>
	<p>Press to leave the Network Viewer program.</p>
	<p>The single sequence.</p>
	<p>Click to page up.</p>
	<p>Click to page down.</p>
	<p>Recorded video list box. This box allows you to access all recorded video, which are stored in the HDD of the connected devices. To review a recorded video, just click an entry from the list and click the  button.  <b>PgUp/PgDn:</b> To scroll up and down the list.</p>
	<p>NVR Status Box. This box indicates the selected device status.  <b>PLAY:</b> The device is in the playback mode.  <b>LIVE:</b> The device is in the live display mode.  <b>WAIT:</b> The device is processing the command.  <b>PAUSE:</b> Pauses the image.</p>



---

TIME SEARCH

6	30	2003	19	33	GO
---	----	------	----	----	----

This allows you to search a recorded video kept in the HDD of the device. Enter the MONTH/DAY/YEAR HOUR: MINUTE you wish to search and click GO to proceed.

---

**Office**  
**192.168.1.249**

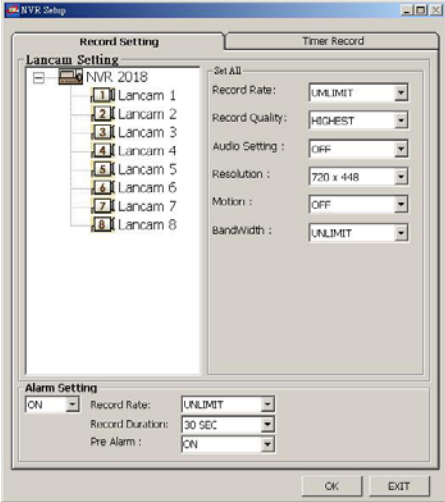
Every NVR has to own an IP address and a title to be identified on the network. This area displays the title and the IP address of the NVR.

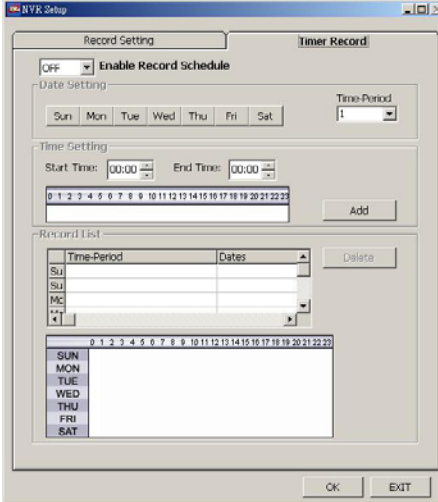


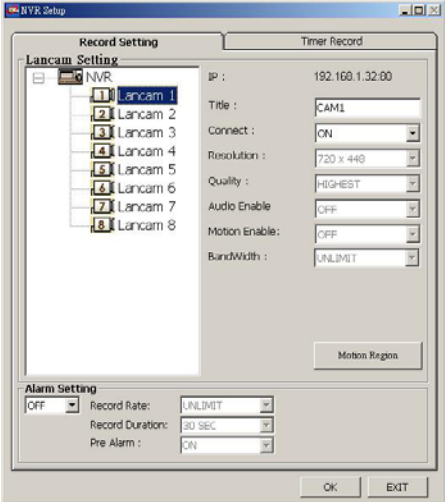
Image display area. Displays the images of each camera and the title information on the top blue bar. Double click the image to view a full screen of the camera.

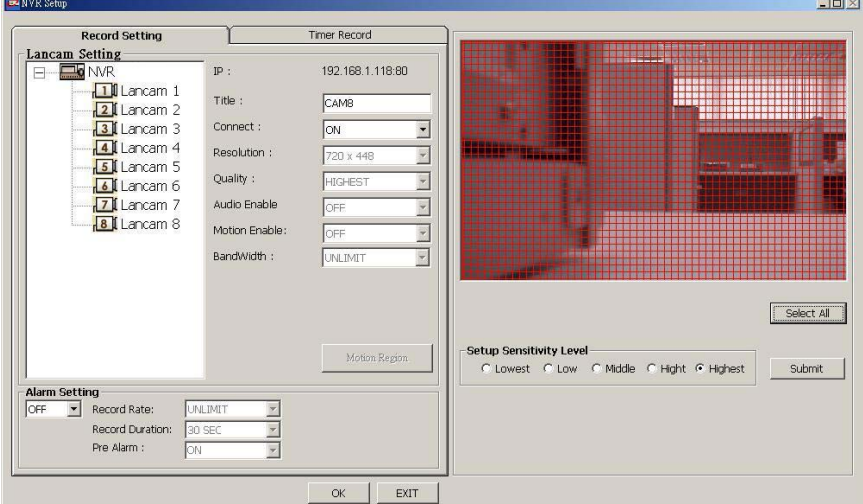
## 9.1.4 Change the Record & Timer Properties Via the Network

Follow the instructions below to reconfigure the record and schedule recording settings via the network.




**A.** 

**B.** 


**C.** 

**D.** 


### Set the regular record settings

1. When in the single –device mode, click  to enter the SETUP page. (See the sample screen as in A above)
2. Select a desired recording rate and Quality from the corresponding drop-down list
3. At the left of the page are itemized Lancam 1( Lancam 1) to 8( Lancam 8) (See the sample screen as in C above), each of which is connected to the corresponding camera. So, if you click any of them, the corresponding camera's information will appear in the blank spaces of all the items on the screen.
4. Adjust the LANCAM setup, including all the items on the screen given below:
  - Title
  - Connect LanCam
  - Motion (See the sample screen as in D above)The information in all the above items' attached spaces can be sent to the NVR.
5. Click the **OK** tag to proceed.

### Set the Alarm record settings


1. When in the single –device mode, click  to enter the SETUP page. (See the sample screen as in A above)
2. Set the ALRM SETTING to ON to enable the drop-down list in the ALARM SETTING area.
3. Select a desired recording rate and Quality from the corresponding drop-down list.
4. Click the **OK** tag to proceed.

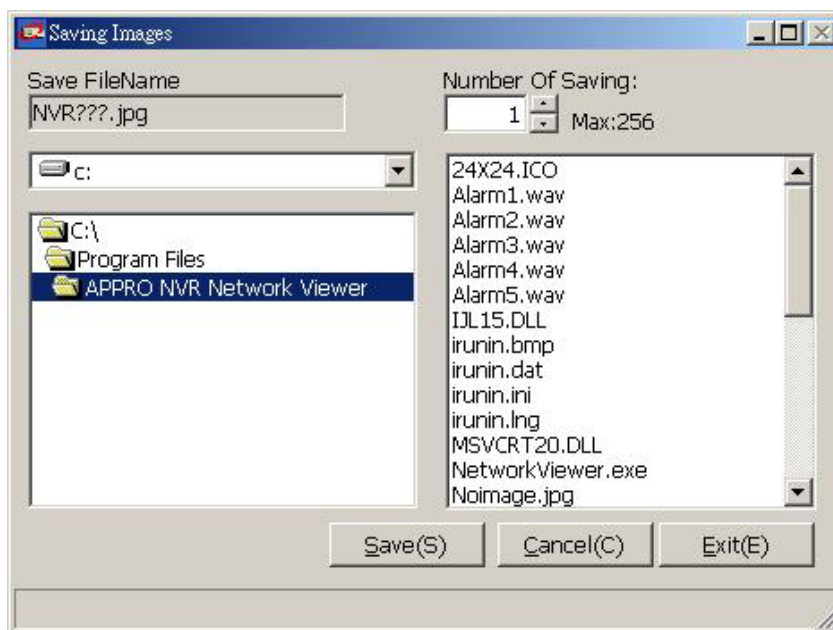
### Set the Record Schedule

1. When in the single –device mode, click  to enter the SETUP page. (See the sample screen as in B above)
2. Set the **Record Schedule** to **ON** to enable the **Record Schedule** setting area.
3. Click the **Time-Period** button to set the schedule for recording for each day. Go to both the **START TIME** & **END TIME** boxes, enter a specific **Hour: Minute** and click **Add** button to add to the **Record List**.
4. When all required settings are completed, click **OK** to proceed.

### 9.1.5 Archive Images to the Computer

Playback images can be stored in a local PC in the JPEG format. Follow the instructions below to save the viewed images to your PC.

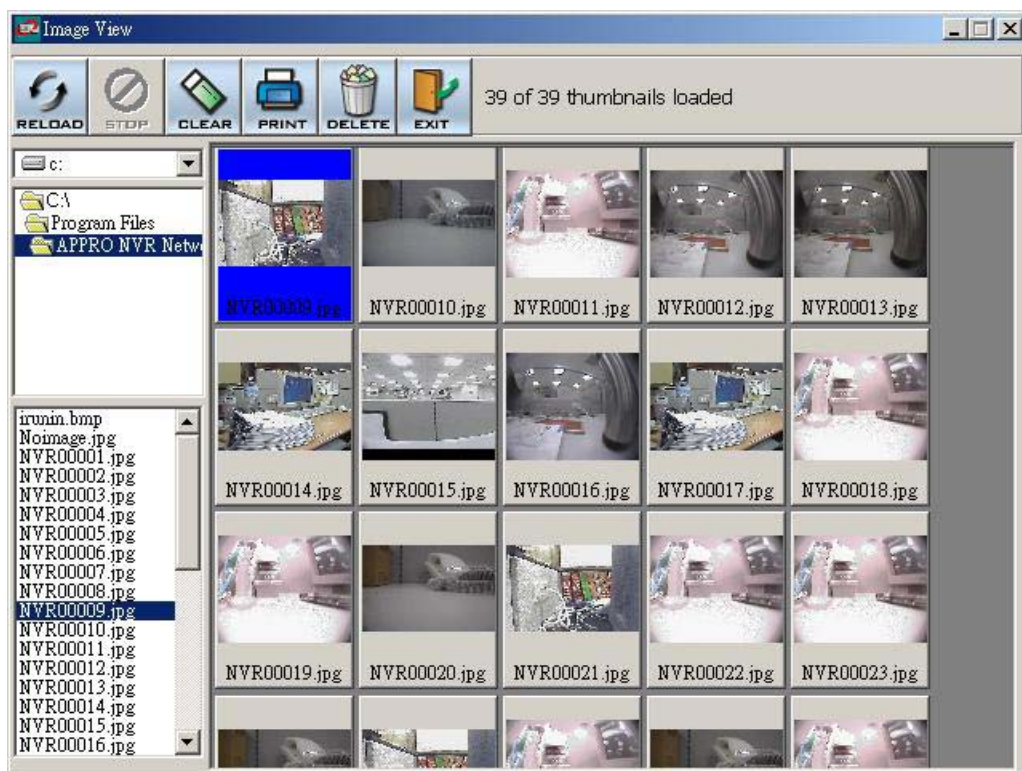
1. Press  to enter the following sample screen whenever in the playback mode.
2. Select a folder in the computer for copying images in.
3. Enter the number of images into the **NUMBER OF SAVING** box you wish to save in.
4. Click the **SAVE** tag; the program will automatically copy the displayed images into the designated folder. The images are saved in the NVRxxx.jpg file name, which is displayed in the box on the right-hand side. To view a saved image, please follow the instructions in the next section to proceed.



## 9.2 The Image Viewer

This is image integrity-protect software. It not only allows you to view an archived image from the SD card or HDD of a computer, but also protects an archived image from reproduction or interpolation. If an image isn't in the original format made by a NVR, the Image Viewer won't display the image and instead will send a warning message "Wrong File, Can't Open". Follow the instructions below to open an archived image from a SD card or a HDD.

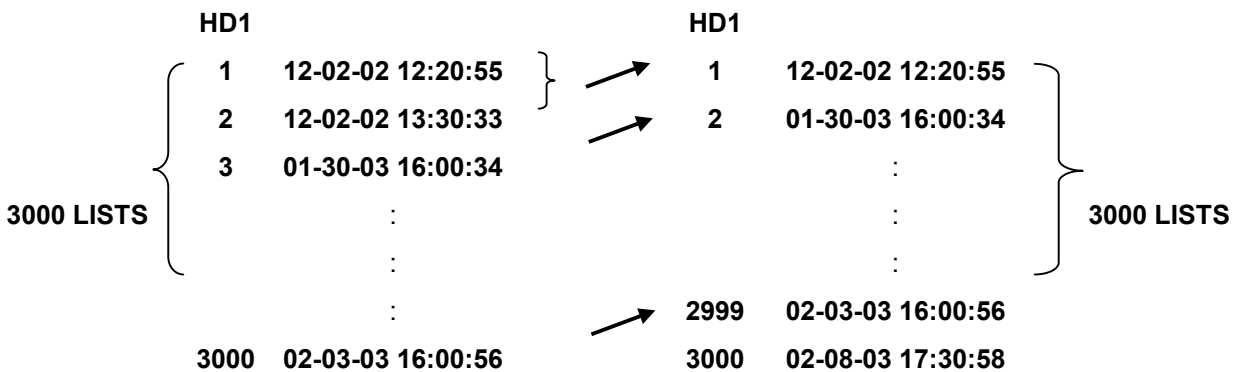
1. Pop up the **START** menu from your computer, and point to **Programs / APPRO NVR Network Viewer** to open up the program selection page. Click the **Image Viewer** tag to start the **Image Viewer** program. (See a sample screen below.)
2. Click the **PRINT** tag to get a displayed image printed out from a printer.



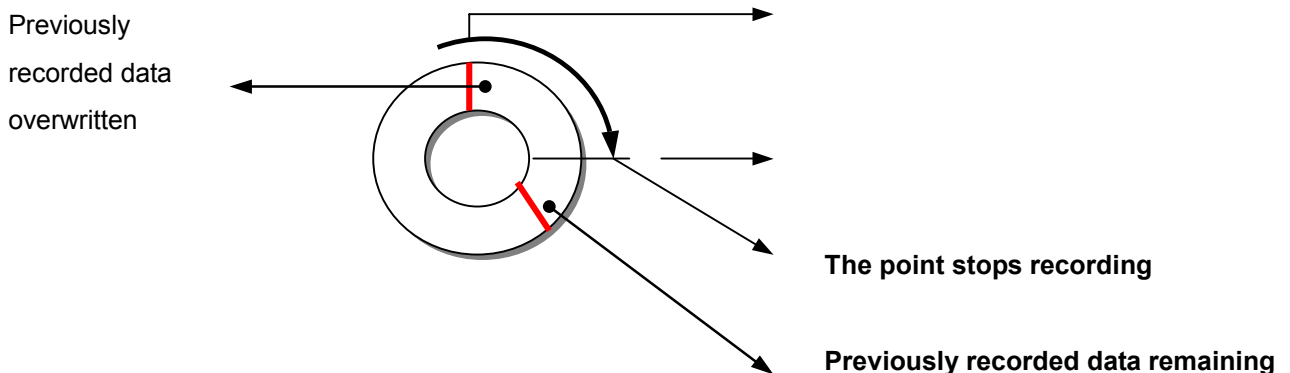
## 10. Index Table

The following description details how the NVR manages an index table issue.

The NVR will generate a time index table indicating recorded data is kept in a particular HDD. This allows to individually selecting recorded data to be displayed via the alarm list search and full list search. The maximum number of lists, for a given HDD, is 3000. When the list of any given HDD is used up-and the disk is not full, The unit will still use the rest of the space for recording. In such a case, an index for the recent recorded data will be generated and the index of the next oldest data will be erased so that the list does remain 3000 in total. And the next oldest data will be kept in the index of the corresponding oldest data. For any newly-recorded data, this approach will be applied until the disk becomes full.



In the rewrite recording mode, when the archived hard disk drive is full, the NVR will start overwriting the oldest data recorded. As the previous recorded data was partially overwritten by the recent recording, the indicating time index of that data will be changed corresponding to the starting time of the remaining session. The index of the session will be deleted from the table when it is fully overwritten.



# 11. Network Configuration

## 11.1 Cable Connections

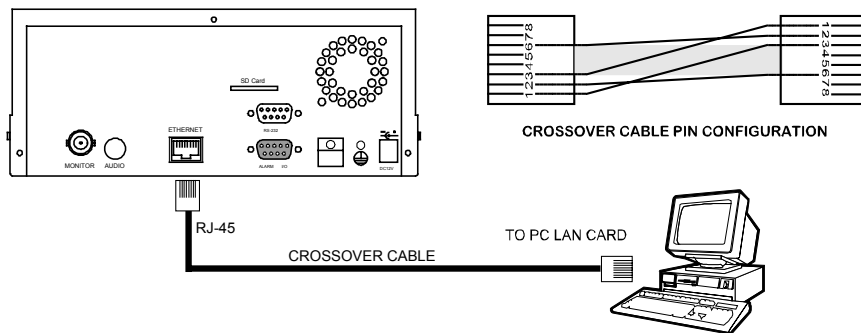
Please follow the instructions below to connect your NVR to a computer or a network and to choose a proper RJ-45 cable configuration for connections.

### Physical specification of RJ-45 cable for Ethernet

<b>Wire Type</b>	Cat. 5
<b>Connector Type</b>	RJ-45
<b>Max. Cable Length</b>	30 m
<b>Hub Wiring Configuration</b>	Straight Through
<b>PC Wiring Configuration</b>	Cross Over

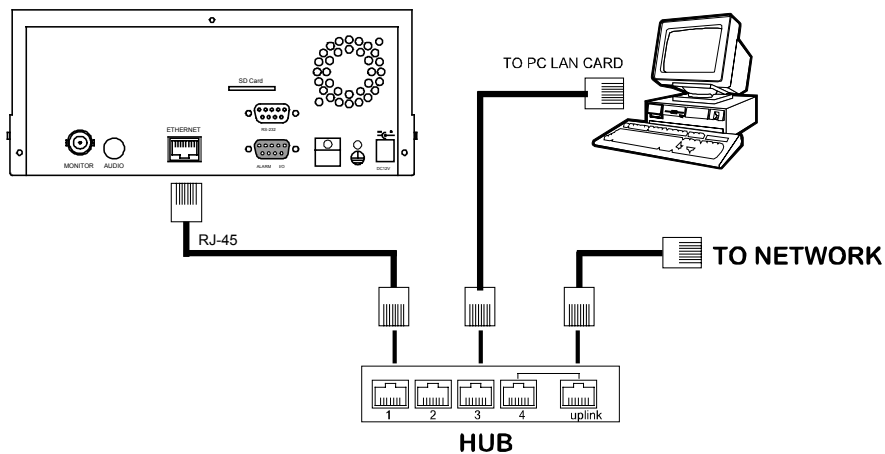
#### 11.1.1 Connect to a computer

Use a crossover LAN cable to connect directly to a computer.



#### 11.1.2 Connect to a LAN Hub (INTRANET)

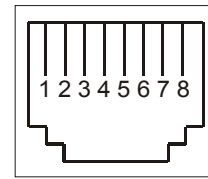
The RJ-45 PIN configuration for connecting with a LAN Hub is shown below.



## RJ-45 PIN configuration for LAN Hub

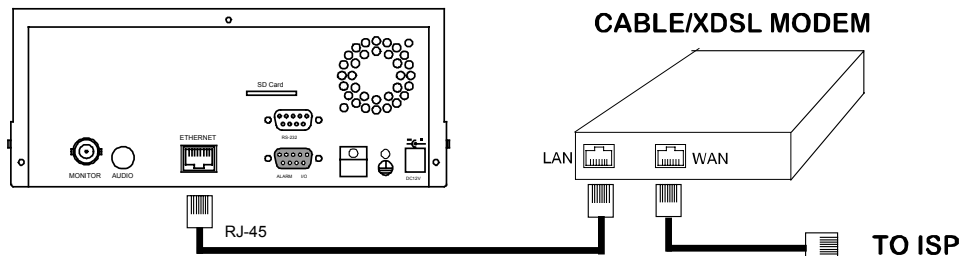
PIN NO.	PIN Assignment
1.	TX +
2.	TX -
3.	RX +
4.	Not Connected
5.	Not Connected
6.	RX -
7.	Not Connected
8.	Not Connected

RJ-45 socket



### 11.1.3 Connect to WAN (INTERNET)

The RJ-45 PIN configuration for connecting to a WAN is the same as connecting to a LAN.

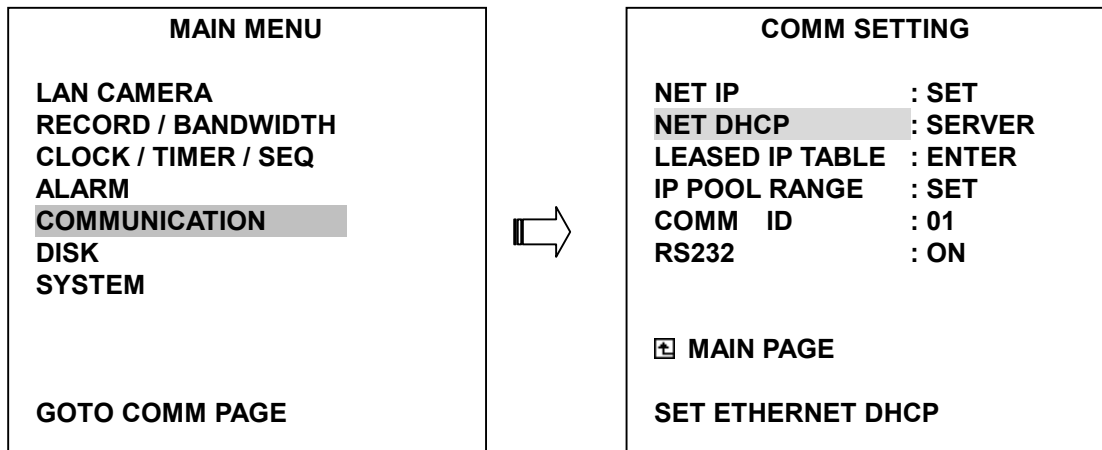


## 11.2 Configure Your NVR Network Settings

Upon network hardware connection, you need to activate the network function and configure the proper network settings of the NVR.

### 11.2.1 Enable DHCP Function

Use the “**▲**” and “**▼**” buttons **12**, and **13**, to highlight NET DHCP; select ON. Then press the **Enter** button to proceed.

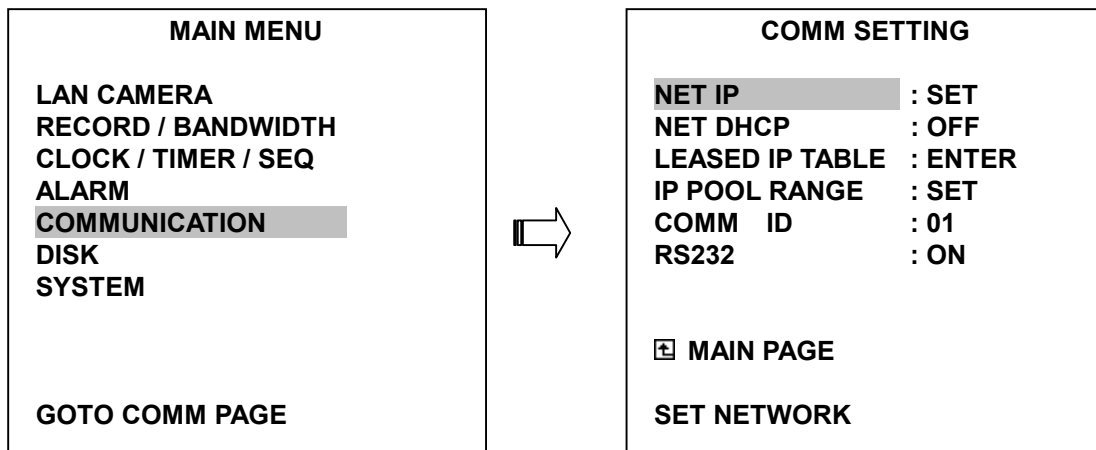




**NOTE:** This function can only work if the LAN which the unit is connected to has a DHCP server. If the DHCP server is working, the NVR will obtain an IP address automatically from the DHCP server. In that case please skip the section 11.2.2 (Set IP address) and follow section 3. (TCP/IP Communication Software).

### 11.2.2 Set IP Address

You don't need to set a NET IP for the unit if the LAN which the unit is connected to has a DHCP server. Otherwise, please follow the instructions given below:



Use the “▲” and “▼” buttons ⑫, and ⑬, to highlight the NET IP. Press the **Enter** button to enter the NET IP page

- Set the IP, MASK and GATEWAY. Then press the **Enter** button to proceed. The following is a sample setting.

```

IP:           192.168.0.1
MASK:        255.255.255.0
GATEWAY:    0.0.0.0
  
```

**NOTE:** When only one unit of the NVR is connected to a computer or LAN, you can freely assign an IP address for the NVR. For example, there is a range of NVR IP addresses from 192.168.0.1 to 192.168.0.255. You can pick one for use from the range of the IP. It's not necessary to set MASK and GATEWAY; leave the settings as default.

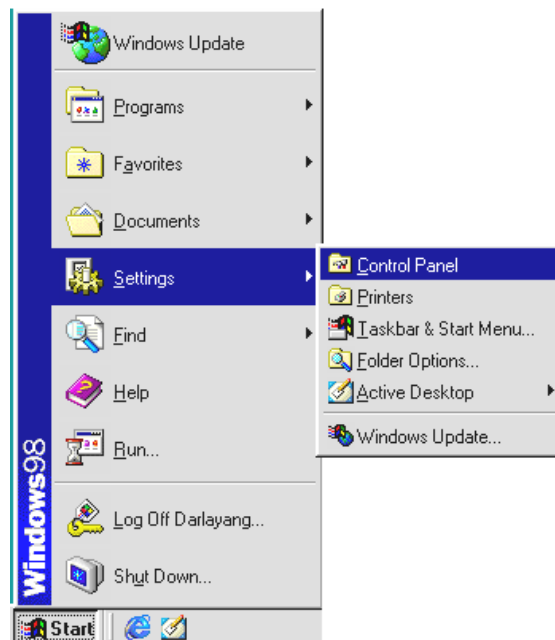
When a NVR is connected to a WAN, you must acquire a unique, permanent IP address and correctly configure the MASK and GATEWAY settings according to your network architecture. If you have any questions regarding those settings, please contact a qualified MIS professional or your ISP.

**NOTE:** When connecting to a network, each connected NVR must be assigned a unique IP, which must be in the same class type as your network address. IP addresses are written as four sets of numbers separated by periods; for example, 192.168.0.1 Therefore, if the connected network is identified as Class C, for example, the first three sets of numbers of the NVR IP address must be the same as the network address. If the connected network is identified as Class B, the first two sets of numbers of the NVR IP address must be the same as the network address. If you have any questions regarding these settings, please contact a qualified MIS professional or your ISP.

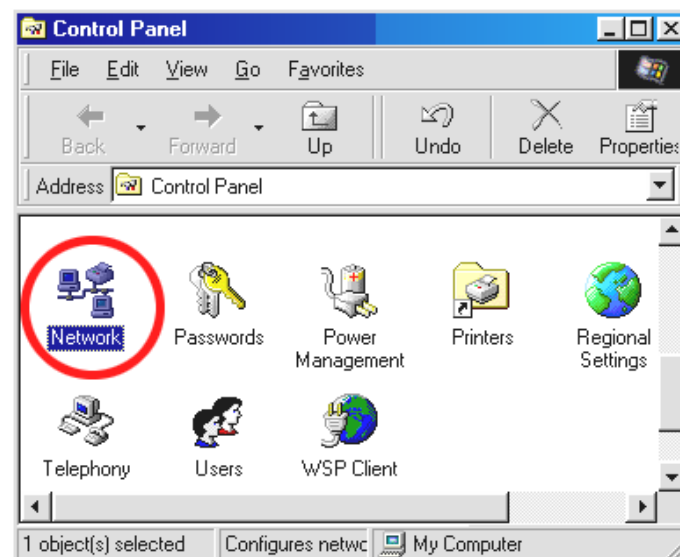
### 11.3 TCP/IP Communication Software

Follow the instructions below to install the TCP/IP communication program into your computer.

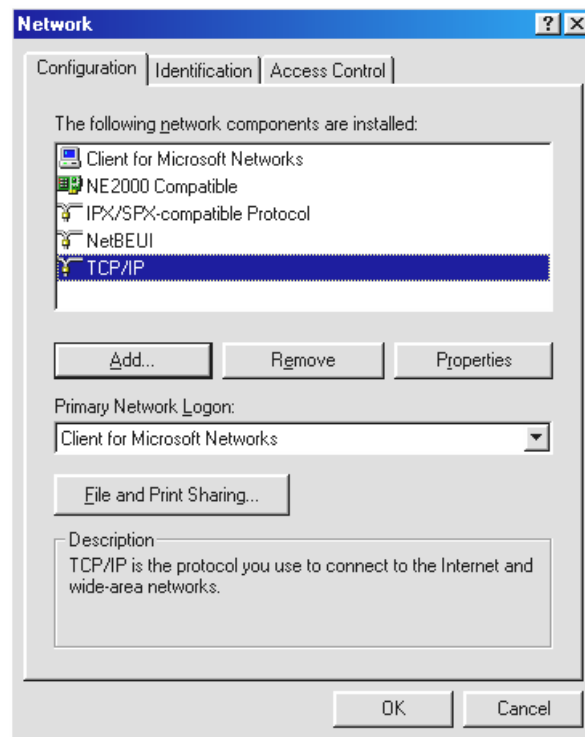
- Click the **Start** Menu from your computer, and point to the **Settings/Control panel**.



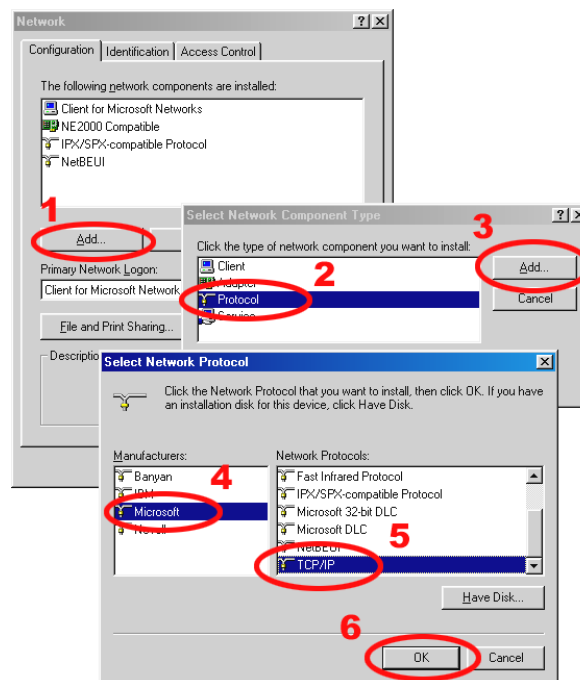
- Click the **NETWORK** icon twice to enter the **NETWORK** setting windows.



- Click on the **Configuration** tag; check if the TCP/IP is included among the network components list. If the TCP/IP is included, please process step 5. If it is not included, please follow step 4 to install the TCP/IP.



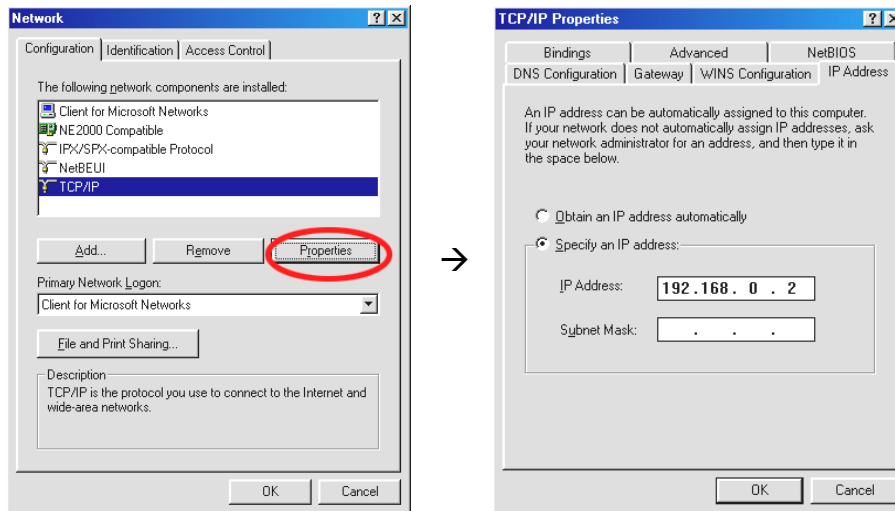
## 11.4 TCP/IP installation



During the installation, you will be requested to insert the windows 98 CD ROM. After installation, the PC will be restarted.

## 11.5 TCP/IP Configuration setting

- Click **Start → Settings → Control Panel → Network.**
- Select **TCP/IP**, and then click **Properties.**
- Before processing the NVR installation in a WAN, please make sure the Internet connection works properly. If not, please contact your ISP provider.



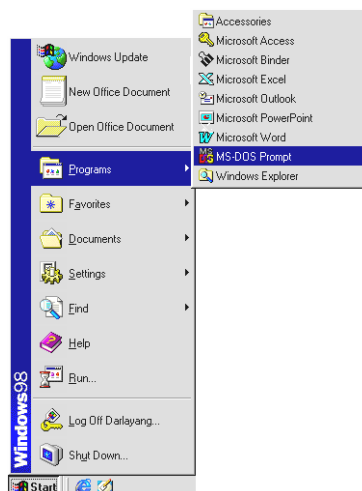
If you are using a DHCP server, please select **Obtain an IP address automatically**. Any assigned IP address for the connected NVRs must be in the same class type as the server. If there is no DHCP server, please select **specify an IP address** and type in the IP address of your PC. This IP address must be different from the NVR IP but in the same class type.

**NOTE: The IP address of a NVR in a network must be unique to itself as opposed to those of the other chosen PCs, but in the same class type**

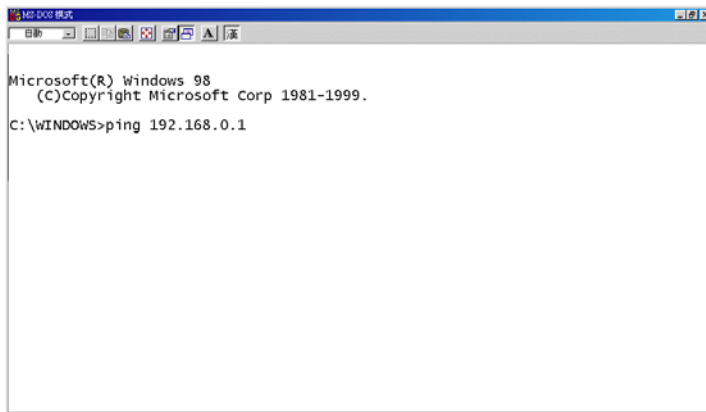
## 11.6 Connection Testing

With the previous settings, follow the instructions below to ensure whether you have established the connection successfully.

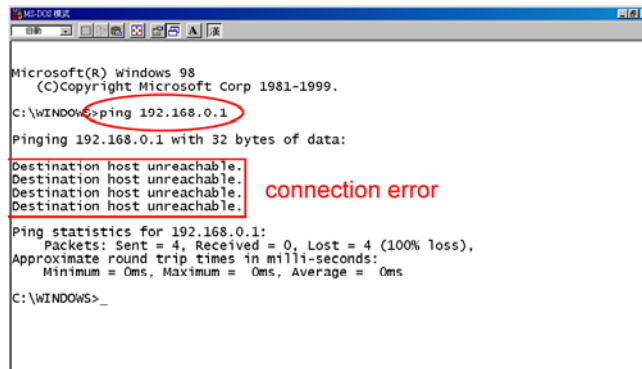
- Click **Start → Programs → MS-DOS Prompt**



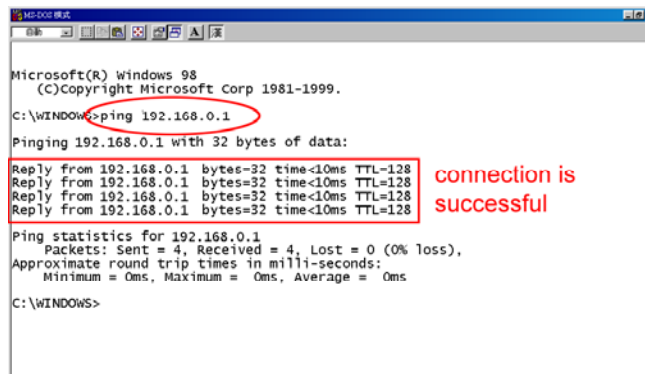
- Type in **ping 192.168.0.1** then Enter. (See the sample screen below)  
 \*\* This IP is the NVR IP address that is assigned for the connected NVR in step 2.



- If you receive a response as in the sample screen below, the connection hasn't been successfully established. Please re-check all the hardware and software installation by repeating steps 1 to 5. If you still can't establish the connection after rechecking, please contact your dealer.



- If you receive a response as in the sample screen below, you have successfully made the connection.



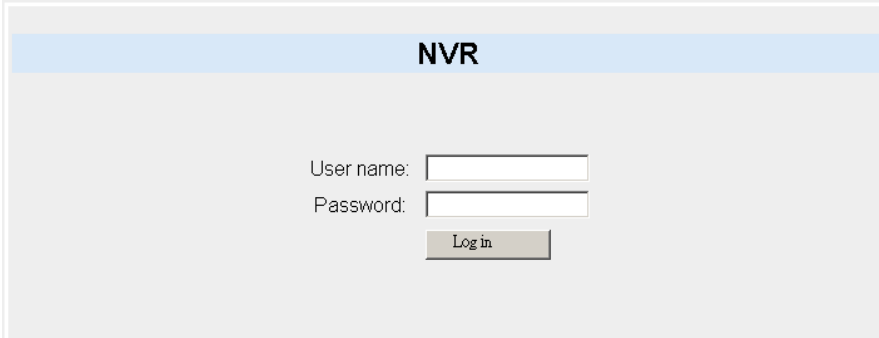
## 12. Microsoft Internet Explorer

This section provides instructions for using the Microsoft Internet Explorer, which are included with the NVR-2018.

### 12.1 Connecting the NVR-2018

Start up the Microsoft Internet Explorer, and then follow the steps given below to connect the NVR-2018:

1. Click the URL block at the top of the screen.
2. Type in the URL address of the NVR-2018 into the URL block and press the **“Enter”** button to enter the login page. The default User Name and password is **admin** and **9999** respectively.
3. Enter the user name (Login Name).
4. Fill in the password (Password).
5. Click the **“Login”** button and enter the home page of the NVR-2018: both the user name and password must be provided correctly.



The screenshot shows a web browser window displaying the NVR login interface. At the top, there is a light blue header bar with the text "NVR" in black. Below the header, the page has a light gray background. In the center, there are two input fields: "User name:" followed by a white text box, and "Password:" followed by a white text box. Below the password field, there is a gray button with the text "Log in" in black.

#### **Description of functional keys:**

**Login Name:** Enter the user name in the blank space.

**Password:** Fill in the password in the blank space.

**Login:** Click to enter the home page of the NVR-2018.

#### **Browsing images from the NVR-2018:**

The images from the NVR-2018 will be displayed on the home page while going online with the NVR-2018. There are some buttons provided on the bottom of the home page for further setting:

The screenshot displays the NVR interface. On the left, there is a 3x3 grid of camera feeds showing various indoor scenes. On the right, the 'NVR' title is at the top, followed by a 'Viewer' tab and a 'Setup' tab. Below this is a 'PLAY LIST' section with a table of recorded video entries. At the bottom, there are control buttons for 'STOP', 'PLAY', 'PAUSE', 'REC', and 'LOGOUT', along with a 'LIVE' status indicator and a 'TIME SEARCH' section with date and time input fields.

Item	Date	Time	Duration
50	29-12-03	12:07:50	14.0M
51	29-12-03	12:08:24	2.00M
52	29-12-03	12:26:15	4.00M
53	29-12-03	12:27:04	4.00M
54	29-12-03	12:27:16	4.00M
55	29-12-03	12:31:56	4.00M
56	29-12-03	12:32:45	2.00M
57	29-12-03	15:23:42	2.00M

HDD 1  
PgUp ▲ PgDn ▼

LIVE : 29/12/2003 15:25:47

TIME SEARCH : Date 29 / 12 / 2003 Time 15 : 23 GO

Function Buttons	Description
	Click to stop playing back the recorded video or to cease recording.
	Click to a recorded video from the PLAY LIST.
	Click to freeze the image.
	Click to activate the recording function of the device.
	Click to leave the home page of the NVR-2018.
	Press to enter the SETUP window, and open the device setting page in order to add more devices for viewing. This allows you to program the Record Setting and Record Schedule.
	Press to enter the IMAGE window and open the device home page for viewing.

PLAY LIST			
50	29-12-03 12:07:50	14.0M	▶
51	29-12-03 12:08:24	2.00M	▶
52	29-12-03 12:26:15	4.00M	▶
53	29-12-03 12:27:04	4.00M	▶
54	29-12-03 12:27:16	4.00M	▶
55	29-12-03 12:31:56	4.00M	▶
56	29-12-03 12:32:45	2.00M	▶
57	29-12-03 15:23:42	2.00M	▶
HDD 1			
PgUp ▲		PgDn ▼	

Recorded video list box. This box allows you to access all recorded video, which are stored in the HDD of the connected devices. To review a recorded video, simply select an entry from the list and click the ▶ button.

**PgUp/PgDn:** Enables you to scroll up and down the list.

LIVE : 29/12/2003 15:25:47

NVR-2018 Time & Status Box. This box indicates the selected device status.

**PLAY:** The device is in the playback mode.

**LIVE:** The device enters the live display mode.

TIME SEARCH : Date 29 / 12 / 2003 Time 15 : 23 GO

This allows you to search a recorded video stored in the HDD of the device. Enter the YEAR/MONTH/DAY HOUR: MINUTE you wish to search and click the GO button to proceed.



- Click the 1 button to see images in the single channel mode. Channel 1 is the default. Click the < (left) button or the > (right) button to view images in the next channels in either the forward or the reverse directions.

- Click the 4 button to see images in the quad mode. Use either the < (left) button or the > (right) button to view the next four channels in either the forward or the reverse directions.

- Click the 8 button to view images in the 8 channel mode.




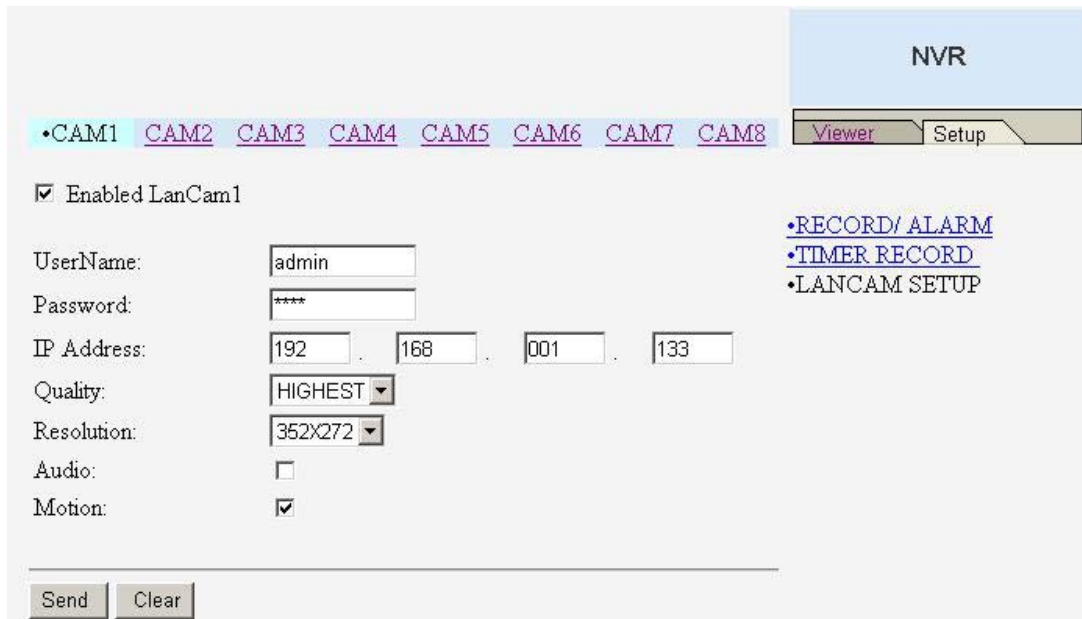
Image display area. Displays images from the 8ch cameras.



## 12.2 Change LANCAM SETUP Setting

Please follow the steps given below to change the LANCAM setting through the network as and when necessary.

- (1) Click the  button on the home page to enter the setup mode.



•CAM1 [CAM2](#) [CAM3](#) [CAM4](#) [CAM5](#) [CAM6](#) [CAM7](#) [CAM8](#) [Viewer](#) [Setup](#)

Enabled LanCam1

UserName:

Password:

IP Address:  .  .  .

Quality:

Resolution:

Audio:




Motion:

[•RECORD/ ALARM](#)  
[•TIMER RECORD](#)  
[•LANCAM SETUP](#)

- (2) At the top of the page are itemized CAMs 1 to 8, each of which is connected to the corresponding camera. So, if you click any of them, the corresponding camera's information will appear in the blank spaces of all the items on the screen.
- (3) Adjust the LANCAM setup, including all the items on the screen given below:

Enabled LanCam  
UserName  
Password  
IP Address  
Quality  
Resolution  
Audio  
Motion

The information in all the above items' attached spaces can be sent to the NVR.

- (4) Click the  button to submit the new LANCAM setting.
- (5) Click the  button to delete all information given against all the items on the screen.
- (6) Click the  button to return to the home page while the new image setting acts on the images to effect the desired changes instantly. (If the setting has not been changed by the above steps, any (re)entry onto the home page will find images in their earlier or original setting. )

## 12.3 Change Record / Alarm Setting

Please follow the steps given below to change the RECORD / ALARM setting through the network as and when necessary.

1. Click the **Setup** button on the home page to enter the setup mode.
2. Click the [•RECORD/ ALARM](#) connection on the setting page to enter the RECORD / ALARM setting page.

**NVR**

Viewer Setup

**NORMAL REC SETTING**

RATE  
UNLIMIT

**ALARM REC SETTING**

ENABLE ON RATE UNLIMIT


•RECORD/ ALARM  
•TIMER RECORD  
•LANCAM SETUP

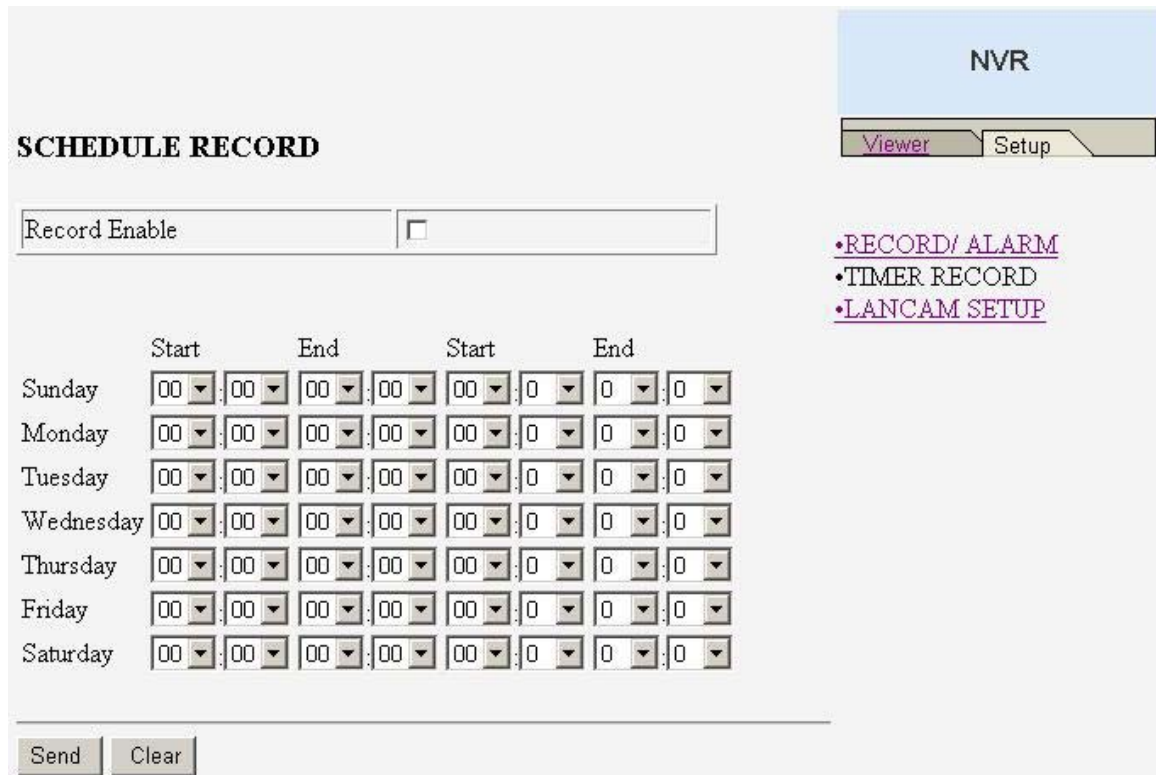
Send Clear

3. Adjust the Record / Alarm setting, including the “NORMAL REC SETTING RATE”, “ALARM REC SETTING ENABLE”, and “ALARM REC SETTING RATE” as and when necessary.
4. Click the **Send** button to submit the new Record / Alarm setting.
5. Click the **Viewer** button to return to the home page while the new image setting acts on the images to effect the desired changes instantly. (If the setting has not been changed by the above steps, any (re)entry onto the home page will find images in their earlier or original setting. )



## 12.4 Change Timer Record Setting

Please follow the steps below to change the Timer Record setting through the network as and when necessary.

1. Click the  button on the home page to enter the setup mode.
2. Click the [•TIMER RECORD](#) connection on the setting page to enter the Timer Record setting page.



	Start		End		Start		End	
Sunday	00	00	00	00	00	00	00	00
Monday	00	00	00	00	00	00	00	00
Tuesday	00	00	00	00	00	00	00	00
Wednesday	00	00	00	00	00	00	00	00
Thursday	00	00	00	00	00	00	00	00
Friday	00	00	00	00	00	00	00	00
Saturday	00	00	00	00	00	00	00	00

3. Set the **SCHEDULE RECORD** to **ON** to enable the **SCHEDULE RECORD** function.
4. There are two time-periods available for scheduling each day. The Timer Record setting page allows users to program the time each day that the NVR-2018 will start and stop recording. The time is displayed in a 24-hour clock format. If there is a time overlap showing between two continual time-period settings, the device will automatically combine the two time-period settings into one combined time-period setting.
5. Click the  button to submit the new Timer Record setting.
6. Click the  button to return to the home page while the new image setting acts on the images to effect the desired changes instantly. (If the setting has not been changed by the above steps, any (re)entry onto the home page will find images in their earlier or original setting. )


## 13. SPECIFICATIONS

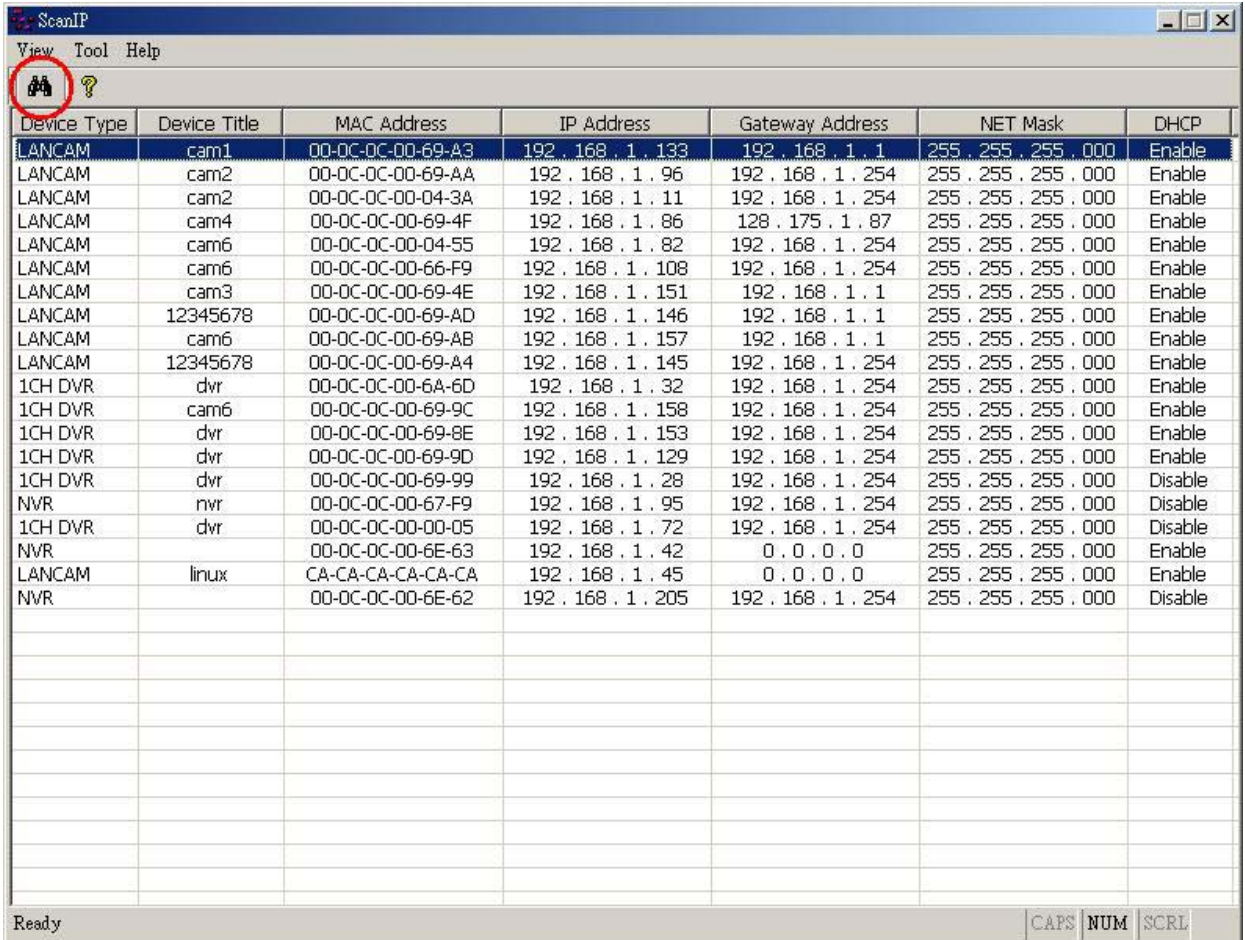
Model Number	8CH NVR-2018	
Lancam Connection	Lancam x 8	
Image System	NTSC	PAL
Image Resolution	720 x 480 pixels 352 x 240 pixels	720 x 576 pixels 352 x 288 pixels
Video Input interface	RJ-45 (bit stream from Lancam)	
Video Out	Mon1 (BNC)	
Audio Input interface	RJ-45 (bit stream from Lancam)	
Audio Out	RCA x 1	
Compression	MJPEG	
Storage Media	> 320 GB / 1 Fixed HDD, 1 Removable HDD	
Memory Card	SD Card	
Archive	Hot Swappable Removable HD	
Watermark	Digital Signature	
Max Recording Rate	20 ips (720x480) 50 ips (352x240)	20 ips (720x576) 50 ips (352x288)
Image Size	4 ~ 64 KB	
Recording Mode	Schedule / Manual / Alarm / Circular	
Alarm Recording	Motion / Event(image) / Pre-Alarm / Post Alarm	
Max Pre-Alarm Recording	256 Pictures	
Playback Speeds	Frame Stepping, 1/32x,1/16x,1/8x,1/4x,1/2x,1x,2x,4x,8x,16x,32x,100x	
Record Search	Alarm / Time / Filter(thumbnail) / SD card	
OSD Language	English / Chinese(T)	
Set-up Menu	Multi-layer / Network setting	
Log list	2048 records	
Alarm In/Out	1 Alarm Output	
Built-in Buzzer	Yes	
Motion Detection	Yes	
Communication Port	RS-232 and Ethernet Port	
Network Interface	Ethernet (RJ-45 10/100 base-Tx) x 1	
Network Protocol	TCP/IP, DHCP, HTTP, UDP, ARP, ICMP	
Software Upgrade	Upgrade via Memory Card(SD Card)	
Password Protection	Menu Setup / Remote Access / Format HDD	
Network Capabilities	Archive image as JPEG formats, Remote system setup and control View live or recorded images	
Power Supply (AC adapter)	Input: 100V-240V, 50 Hz/60 Hz; Output: DC12V max 5A	
Dimensions	220 mm x 94 mm x 340 mm EIA 19" 2U Half Size Mountable	
Weight	About 3.9 kg (without HDD)	
Operation Temperature	5° C ~ 40° C (41° F ~ 104° F)	
Regulation	FCC, CE	
Provided Accessories	AC Adapter x 1	
	Instruction manual x 1	
	Power cord x 1	
	CD-R x 1	
	Screw ( #6-32UNC ) x 4, Screw ( M3 ) x 8(not in use)	
	Mobile Rack Key x 2	

**\*Design and specifications subject to change without notice.**

## APPENDIX 1. –SCANIP

Follow the instructions below to use the SCANIP software to search the NVR devices from a local location.

1. Click the  button to discover the connection of the all-type device in the LAN. The **Device List** will display the connection of the all-type device.
2. Select the desired device from the **Device List**.
3. Click the desired device to show the window while the NVR information acts to display the desired changes instantly.



The screenshot shows the ScanIP application window with a menu bar (View, Tool, Help) and a toolbar containing a discover button (circled in red) and a help button. Below the toolbar is a table listing discovered devices with columns for Device Type, Device Title, MAC Address, IP Address, Gateway Address, NET Mask, and DHCP status.

Device Type	Device Title	MAC Address	IP Address	Gateway Address	NET Mask	DHCP
LANCAM	cam1	00-0C-0C-00-69-A3	192.168.1.133	192.168.1.1	255.255.255.000	Enable
LANCAM	cam2	00-0C-0C-00-69-AA	192.168.1.96	192.168.1.254	255.255.255.000	Enable
LANCAM	cam2	00-0C-0C-00-04-3A	192.168.1.11	192.168.1.254	255.255.255.000	Enable
LANCAM	cam4	00-0C-0C-00-69-4F	192.168.1.86	128.175.1.87	255.255.255.000	Enable
LANCAM	cam6	00-0C-0C-00-04-55	192.168.1.82	192.168.1.254	255.255.255.000	Enable
LANCAM	cam6	00-0C-0C-00-66-F9	192.168.1.108	192.168.1.254	255.255.255.000	Enable
LANCAM	cam3	00-0C-0C-00-69-4E	192.168.1.151	192.168.1.1	255.255.255.000	Enable
LANCAM	12345678	00-0C-0C-00-69-AD	192.168.1.146	192.168.1.1	255.255.255.000	Enable
LANCAM	cam6	00-0C-0C-00-69-AB	192.168.1.157	192.168.1.1	255.255.255.000	Enable
LANCAM	12345678	00-0C-0C-00-69-A4	192.168.1.145	192.168.1.254	255.255.255.000	Enable
1CH DVR	dvr	00-0C-0C-00-6A-6D	192.168.1.32	192.168.1.254	255.255.255.000	Enable
1CH DVR	cam6	00-0C-0C-00-69-9C	192.168.1.158	192.168.1.254	255.255.255.000	Enable
1CH DVR	dvr	00-0C-0C-00-69-8E	192.168.1.153	192.168.1.254	255.255.255.000	Enable
1CH DVR	dvr	00-0C-0C-00-69-9D	192.168.1.129	192.168.1.254	255.255.255.000	Enable
1CH DVR	dvr	00-0C-0C-00-69-99	192.168.1.28	192.168.1.254	255.255.255.000	Disable
NVR	nvr	00-0C-0C-00-67-F9	192.168.1.95	192.168.1.254	255.255.255.000	Disable
1CH DVR	dvr	00-0C-0C-00-00-05	192.168.1.72	192.168.1.254	255.255.255.000	Disable
NVR		00-0C-0C-00-6E-63	192.168.1.42	0.0.0.0	255.255.255.000	Enable
LANCAM	linux	CA-CA-CA-CA-CA-CA	192.168.1.45	0.0.0.0	255.255.255.000	Enable
NVR		00-0C-0C-00-6E-62	192.168.1.205	192.168.1.254	255.255.255.000	Disable

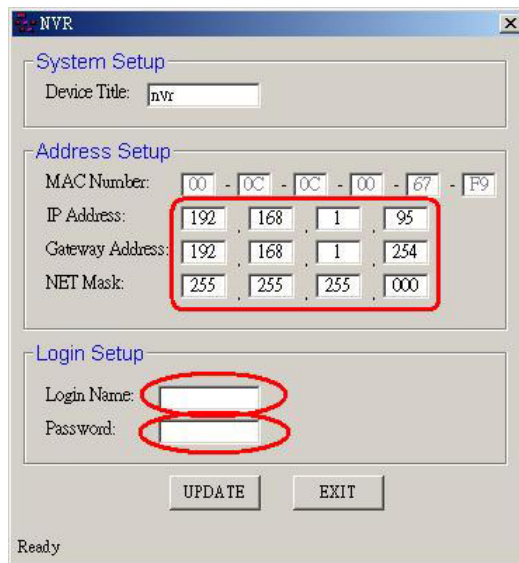
4. Do you want to execute auto search free IP?

If and when you want to auto search the free IP, select “Yes” or “No”. If clicked “Yes” the software will provide the “Free IP Address” boxes on the right side of the window. If you click “No”, these address boxes will not show.



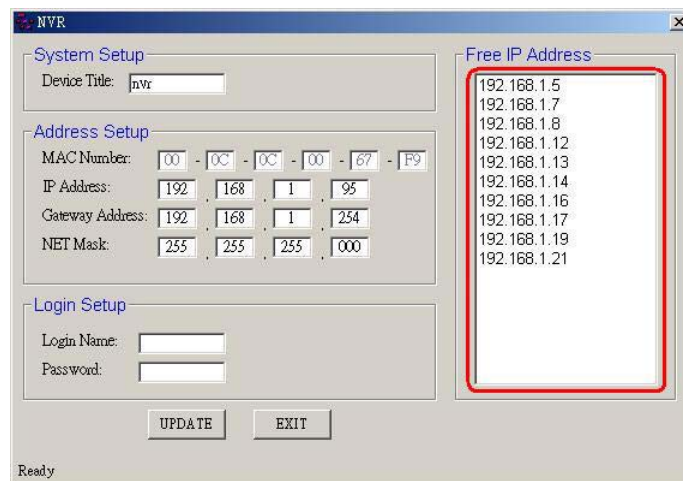
5. Manual insertion of "Free IP Address".

If you have clicked "No", please manually type in insertions as required in the "Free IP Address", "Gateway Address", and "NET Mask". Follow each insertion you make by typing in the "Login Name" and "Password", and click "UPDATE" to send your alterations to the NVR.

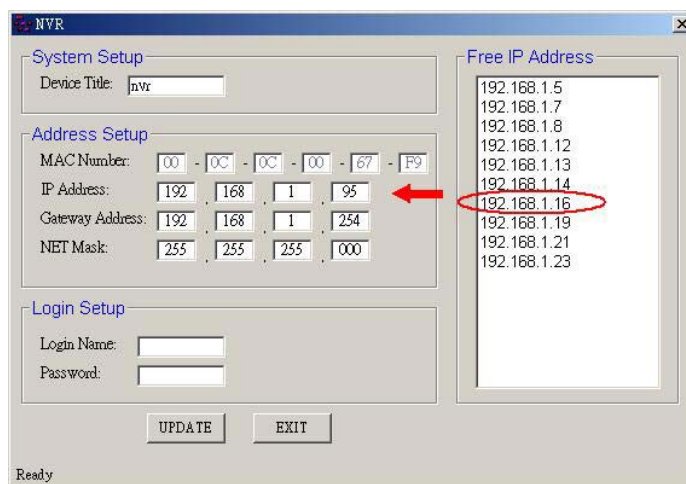


6. Auto search "Free IP Address".

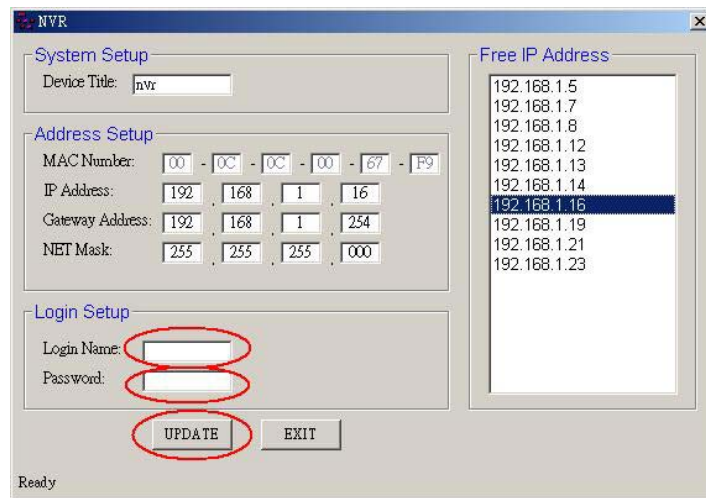
If you clicked "Yes" the "Free IP Address" box will appear on the right.



7. Select and double click any of the addresses in the "Free IP Address" box on the right to enter it into an IP Address on the left.



- To change any IP address, type in the new address in the “Free IP Address” box on the right as well as the device “Login Name” and “Password” in their respective blanks at bottom left, then click “UPDATE”, and the new address will automatically be sent to the device.



- Click “Exit” at bottom right to shut the device.

## Free Manuals Download Website

<http://myh66.com>

<http://usermanuals.us>

<http://www.somanuals.com>

<http://www.4manuals.cc>

<http://www.manual-lib.com>

<http://www.404manual.com>

<http://www.luxmanual.com>

<http://aubethermostatmanual.com>

Golf course search by state

<http://golfingnear.com>

Email search by domain

<http://emailbydomain.com>

Auto manuals search

<http://auto.somanuals.com>

TV manuals search

<http://tv.somanuals.com>