

# **ASUS<sup>®</sup> Terminator P4 533**

## **Barebone System**

### **User's Guide**



# Disclaimer/Copyrights

**Copyright © 2002 ASUSTeK COMPUTER INC. All Rights Reserved.**

No part of this manual, including the products and software described in it, may be reproduced, transmitted, transcribed, stored in a retrieval system, or translated into any language in any form or by any means, except documentation kept by the purchaser for backup purposes, without the express written permission of ASUSTeK COMPUTER INC. ("ASUS").

Product warranty or service will not be extended if: (1) the product is repaired, modified or altered, unless such repair, modification or alteration is authorized in writing by ASUS; or (2) the serial number of the product is defaced or missing.

ASUS PROVIDES THIS MANUAL "AS IS" WITHOUT WARRANTY OF ANY KIND, EITHER EXPRESS OR IMPLIED, INCLUDING BUT NOT LIMITED TO THE IMPLIED WARRANTIES OR CONDITIONS OF MERCHANTABILITY OR FITNESS FOR A PARTICULAR PURPOSE. IN NO EVENT SHALL ASUS, ITS DIRECTORS, OFFICERS, EMPLOYEES OR AGENTS BE LIABLE FOR ANY INDIRECT, SPECIAL, INCIDENTAL, OR CONSEQUENTIAL DAMAGES (INCLUDING DAMAGES FOR LOSS OF PROFITS, LOSS OF BUSINESS, LOSS OF USE OR DATA, INTERRUPTION OF BUSINESS AND THE LIKE), EVEN IF ASUS HAS BEEN ADVISED OF THE POSSIBILITY OF SUCH DAMAGES ARISING FROM ANY DEFECT OR ERROR IN THIS MANUAL OR PRODUCT.

SPECIFICATIONS AND INFORMATION CONTAINED IN THIS MANUAL ARE FURNISHED FOR INFORMATIONAL USE ONLY, AND ARE SUBJECT TO CHANGE AT ANY TIME WITHOUT NOTICE, AND SHOULD NOT BE CONSTRUED AS A COMMITMENT BY ASUS. ASUS ASSUMES NO RESPONSIBILITY OR LIABILITY FOR ANY ERRORS OR INACCURACIES THAT MAY APPEAR IN THIS MANUAL, INCLUDING THE PRODUCTS AND SOFTWARE DESCRIBED IN IT.

Products and corporate names appearing in this manual may or may not be registered trademarks or copyrights of their respective companies, and are used only for identification or explanation and to the owners' benefit, without intent to infringe.

Product Name:	<b>ASUS Terminator P4 533 Barebone System</b>
Manual Revision:	<b>1.00 E1032</b>
Release Date:	<b>June 2002</b>

# Table of contents

Disclaimer/Copyrights .....	2
FCC/CDC statements .....	5
Safety information .....	6
About this guide .....	7
ASUS contact information .....	9
System package contents .....	10
<b>Chapter 1: System Introduction .....</b>	<b>11</b>
1.1 Front Panel Features .....	12
1.2 Rear Panel Features .....	13
1.3 Internal Features .....	14
<b>Chapter 2: Basic Installation .....</b>	<b>15</b>
2.1 Remove the cover .....	16
2.2 Detach the drive frame .....	17
2.3 Install a CPU .....	19
2.4 Install the CPU heatsink and fan .....	21
2.5 Install system memory .....	23
2.6 Install a hard disk drive .....	24
2.7 Install a CD-ROM drive .....	26
2.8 Install a PCI expansion card .....	28
2.9 Re-connect cables .....	29
2.9.1 Front panel .....	29
2.9.2 UAEX and USB-CF extension modules .....	30
2.10 Replace the cover .....	31
2.11 Connect External Devices .....	33
2.12 Power Supply Specifications .....	34
2.12.1 Input Characteristics .....	34
2.12.2 Output Characteristics .....	34
2.12.3 Over-Voltage Protection (OVP) .....	34
<b>Chapter 3: Motherboard Information .....</b>	<b>35</b>
3.1 Introduction .....	36
3.2 Motherboard components .....	36
3.3 Motherboard layout .....	39
3.4 Central Processing Unit (CPU) .....	40

3.5	System memory .....	41
3.5.1	Memory configurations .....	41
3.6	Expansion slots .....	42
3.6.1	Configuring an expansion card .....	42
3.6.2	Standard Interrupt Assignments .....	42
3.6.3	IRQ assignments for this motherboard .....	42
3.7	Jumpers .....	43
3.8	Connectors .....	45
<b>Chapter 4: BIOS Information .....</b>		<b>55</b>
4.1	Managing and updating the BIOS .....	54
4.1.1	Using the computer system for the first time .....	54
4.1.2	Updating BIOS procedures .....	56
4.2	BIOS Setup program .....	58
4.2.1	BIOS menu bar .....	59
4.2.2	Legend bar .....	59
4.3	Main Menu .....	61
4.3.1	Primary and Secondary Master/Slave .....	63
4.3.2	Keyboard Features .....	67
4.4	Advanced Menu .....	68
4.4.1	Chip Configuration .....	70
4.4.2	I/O Device Configuration .....	72
4.4.3	PCI Configuration .....	74
4.5	Power Menu .....	77
4.5.1	Power Up Control .....	79
4.5.2	Hardware Monitor .....	81
4.6	Boot Menu .....	83
4.7	Exit Menu .....	85
<b>Chapter 5: Starting up .....</b>		<b>89</b>
5.1	Install an operating system .....	90
5.2	Support CD information .....	90
5.2.1	Running the support CD .....	90
5.2.2	Installation menus .....	91
5.2.3	Software and drivers description .....	92
5.3	Software information .....	94
5.3.1	ASUS Update .....	94
5.3.2	ASUS PC Probe .....	96

# FCC/CDC statements

## Federal Communications Commission Statement

This device complies with FCC Rules Part 15. Operation is subject to the following two conditions:

- This device may not cause harmful interference, and
- This device must accept any interference received including interference that may cause undesired operation.

This equipment has been tested and found to comply with the limits for a Class B digital device, pursuant to Part 15 of the FCC Rules. These limits are designed to provide reasonable protection against harmful interference in a residential installation. This equipment generates, uses and can radiate radio frequency energy and, if not installed and used in accordance with manufacturer's instructions, may cause harmful interference to radio communications. However, there is no guarantee that interference will not occur in a particular installation. If this equipment does cause harmful interference to radio or television reception, which can be determined by turning the equipment off and on, the user is encouraged to try to correct the interference by one or more of the following measures:

- Reorient or relocate the receiving antenna.
- Increase the separation between the equipment and receiver.
- Connect the equipment to an outlet on a circuit different from that to which the receiver is connected.
- Consult the dealer or an experienced radio/TV technician for help.

---

### **WARNING!**

The use of shielded cables for connection of the monitor to the graphics card is required to assure compliance with FCC regulations. Changes or modifications to this unit not expressly approved by the party responsible for compliance could void the user's authority to operate this equipment.

---

## Canadian Department of Communications Statement

This digital apparatus does not exceed the Class B limits for radio noise emissions from digital apparatus set out in the Radio Interference Regulations of the Canadian Department of Communications.

**This class B digital apparatus complies with Canadian ICES-003.**

# Safety information

## Electrical safety

- To prevent electrical shock hazard, disconnect the power cable from the electrical outlet before relocating the system.
- When adding or removing devices to or from the system, ensure that the power cables for the devices are unplugged before the signal cables are connected.
- Before connecting or removing cables from the motherboard, ensure that all power cables are unplugged.
- Seek professional assistance before using an adapter or extension cord. These devices could interrupt the grounding circuit.
- Make sure that your power supply is set to the correct voltage in your area. If you are not sure about the voltage of the electrical outlet you are using, contact your local power company.
- If the power supply is broken, do not try to fix it by yourself. Contact a qualified service technician or your retailer.

## Operation safety

- Before installing devices into the system, carefully read all the documentation that came with the package.
- Before using the product, make sure all cables are correctly connected and the power cables are not damaged. If you detect any damage, contact your dealer immediately.
- To avoid short circuits, keep paper clips, screws, and staples away from connectors, slots, sockets and circuitry.
- Avoid dust, humidity, and temperature extremes. Do not place the product in any area where it may become wet.
- Place the product on a stable surface.
- If you encounter technical problems with the product, contact a qualified service technician or your retailer.

# About this guide

## Audience

This guide provides general information and installation instructions about the ASUS Terminator P4 533 Barebone System. This guide is intended for experienced users and integrators with hardware knowledge of personal computers.

## How this guide is organized

This document contains the following parts:

- 1. Chapter 1: System Introduction**  
This chapter gives a general description of the ASUS Terminator P4 533 barebone system. It includes introduction on the front and rear panel features, and the internal features.
- 2. Chapter 2: Basic Installation**  
This chapter tells how to install components into the barebone system through illustrated step-by-step instructions.
- 3. Chapter 3: Motherboard Information**  
This chapter gives information about the P4SC-E motherboard that came with the system. This chapter includes the motherboard layout, jumper settings, and connector locations. It also includes information on the USB/audio board located on the front panel.
- 4. Chapter 4: BIOS information**  
This chapter tells how to change system settings through the BIOS Setup menus. It includes detailed descriptions of the BIOS parameters.
- 5. Chapter 5: Starting up**  
This chapter helps you power up your system and install drivers and utilities that came with the support CD.

# About this guide

## Conventions used in this guide

---

<b>WARNING!</b>	Information to prevent injury to yourself when trying to complete a task.
<b>CAUTION!</b>	Information to prevent damage to the components when trying to complete a task.
<b>IMPORTANT</b>	Information that you <b>MUST</b> follow to complete a task.
<b>NOTE</b>	Tips and additional information to aid in completing a task.

---

## Where to find more information

Refer to the following sources for additional information and for product and software updates.

### 1. **ASUS Websites**

The ASUS websites worldwide provide updated information on ASUS hardware and software products. The ASUS websites are listed on page 9.

### 2. **Optional Documentation**

Your product package may include optional documentation, such as warranty flyers, that may have been added by your dealer. These documents are not part of the standard package.



# ASUS contact information

## ASUSTeK COMPUTER INC. (Asia-Pacific)

Address: 150 Li-Te Road, Peitou, Taipei, Taiwan 112  
General Tel: +886-2-2894-3447  
General Fax: +886-2-2894-3449  
General Email: info@asus.com.tw

### *Technical Support*

MB/Others (Tel): +886-2-2890-7121 (English)  
Notebook (Tel): +886-2-2890-7122 (English)  
Desktop/Server (Tel): +886-2-2890-7123 (English)  
Support Fax: +886-2-2890-7698  
Support Email: tsd@asus.com.tw  
Web Site: www.asus.com.tw  
Newsgroup: cscnews.asus.com.tw

## ASUS COMPUTER INTERNATIONAL (America)

Address: 6737 Mowry Avenue, Mowry Business Center,  
Building 2, Newark, CA 94560, USA  
General Fax: +1-510-608-4555  
General Email: tmd1@asus.com

### *Technical Support*

Support Fax: +1-510-608-4555  
General Support: +1-502-995-0883  
Web Site: www.asus.com  
Support Email: tsd@asus.com

## ASUS COMPUTER GmbH (Europe)

Address: Harkortstr. 25, 40880 Ratingen, BRD, Germany  
General Fax: +49-2102-442066  
General Email: sales@asuscom.de (for marketing requests only)

### *Technical Support*

Support Hotline: MB/Others: +49-2102-9599-0  
Notebook (Tel): +49-2102-9599-10  
Support Fax: +49-2102-9599-11  
Support (Email): www.asuscom.de/de/support (for online support)  
Web Site: www.asuscom.de

# System package contents

Check your ASUS Terminator P4 533 package for the following items:

1. Barebone system
2. Motherboard
3. Switching power supply
4. 1.44MB floppy disk drive
5. CD-ROM Drive (optional)
6. 56K PCI modem card (optional)
7. Support CD
8. User's guide

---

## NOTE

Optional items may not be present in your package.

If any of the above items is damaged or missing, contact your dealer immediately.

---

---

## IMPORTANT

If you are assembling the system by yourself, make sure to prepare all the components before starting. It saves you a lot of time not having to hunt down components when you need them.

---

# Chapter 1

This chapter gives a general description of the ASUS Terminator P4 533 barebone system. It includes introduction on the front and rear panel features, and the internal features.

# System Introduction

# 1.1 Front Panel Features

The ASUS Terminator P4 533 barebone system is composed of the ASUS P4SC motherboard, a power supply, and a floppy disk drive in the ASUS TriOptix form factor chassis. The chassis front bezel may vary as shown.

---

## NOTE

The CD-ROM drive and modem card are optional items.

---

### Chassis 1

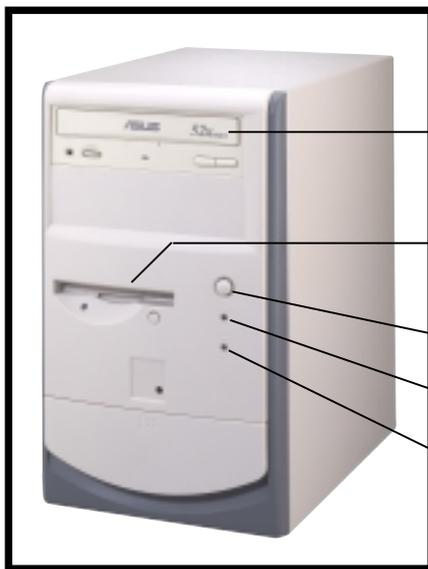

### Chassis 2



CD-ROM Drive (optional)  
Floppy Drive  
Power Button  
Power LED  
HDD LED

CF Card Slot    Headphone Jack  
USB Ports      Microphone Jack

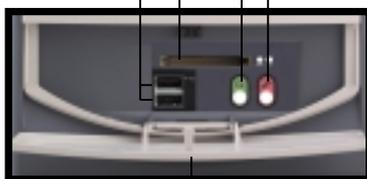

Front Panel I/O Door

CF Card Slot    Headphone Jack  
USB Ports      Microphone Jack



Front Panel I/O Door

The lower part of the front panel is a door that covers accessible I/O features including a Compact Flash card slot, two USB ports (Ports 2&3), a headphone jack, and a microphone jack.

Open chassis 1 I/O door by pressing the dotted area of the door.

Open chassis 2 I/O door by flipping up the door.

## 1.2 Rear Panel Features

The rear panel of the ASUS Terminator P4 533 barebone system includes the standard PC99 I/O connectors for external devices, power supply socket, and optional modem connectors.

The following figure shows the rear panel features.

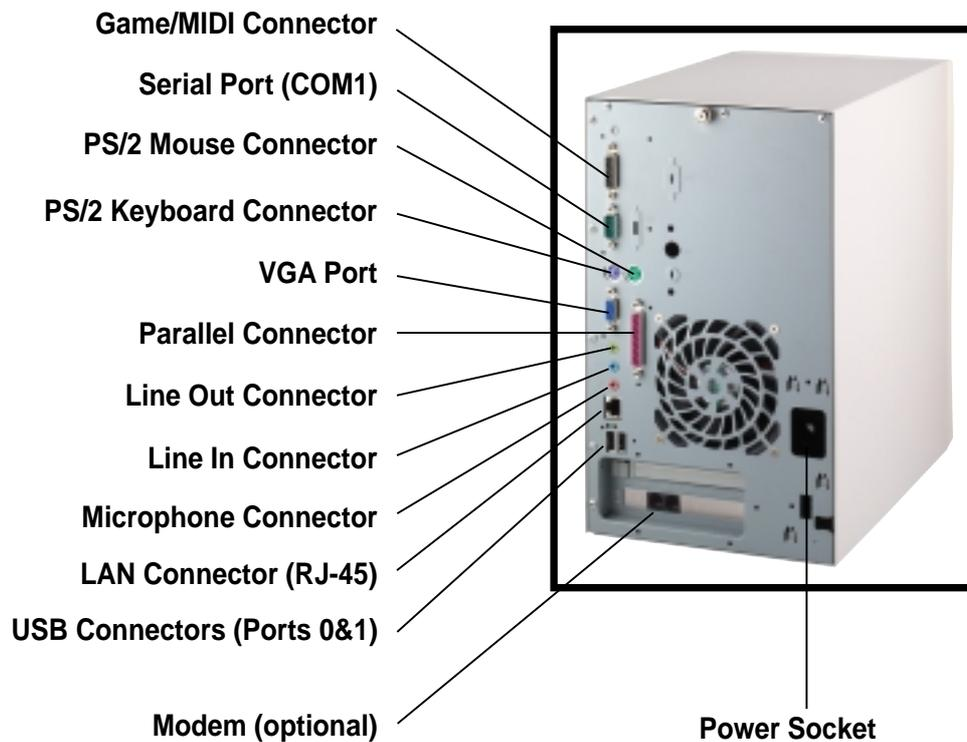

### Voltage Selector

The switching power supply that came with the system has a voltage selector switch below the power socket. Use this switch to select the appropriate voltage according to the voltage supply in your area.

If the voltage supply in your area is 100-127V, set the switch to 115V.

If the voltage supply in your area is 200-240V, set the switch to 230V.



115V/230V  
Voltage Selector

---

#### CAUTION!

Setting the switch to 115V in a 230V environment will seriously damage the system!

---

## 1.3 Internal Features

The figure below shows the internal view of the system when you remove the cover and flip out the drive frame. You will see here the standard components that come already installed in the system and the places where you can install the other required components to get the system running.

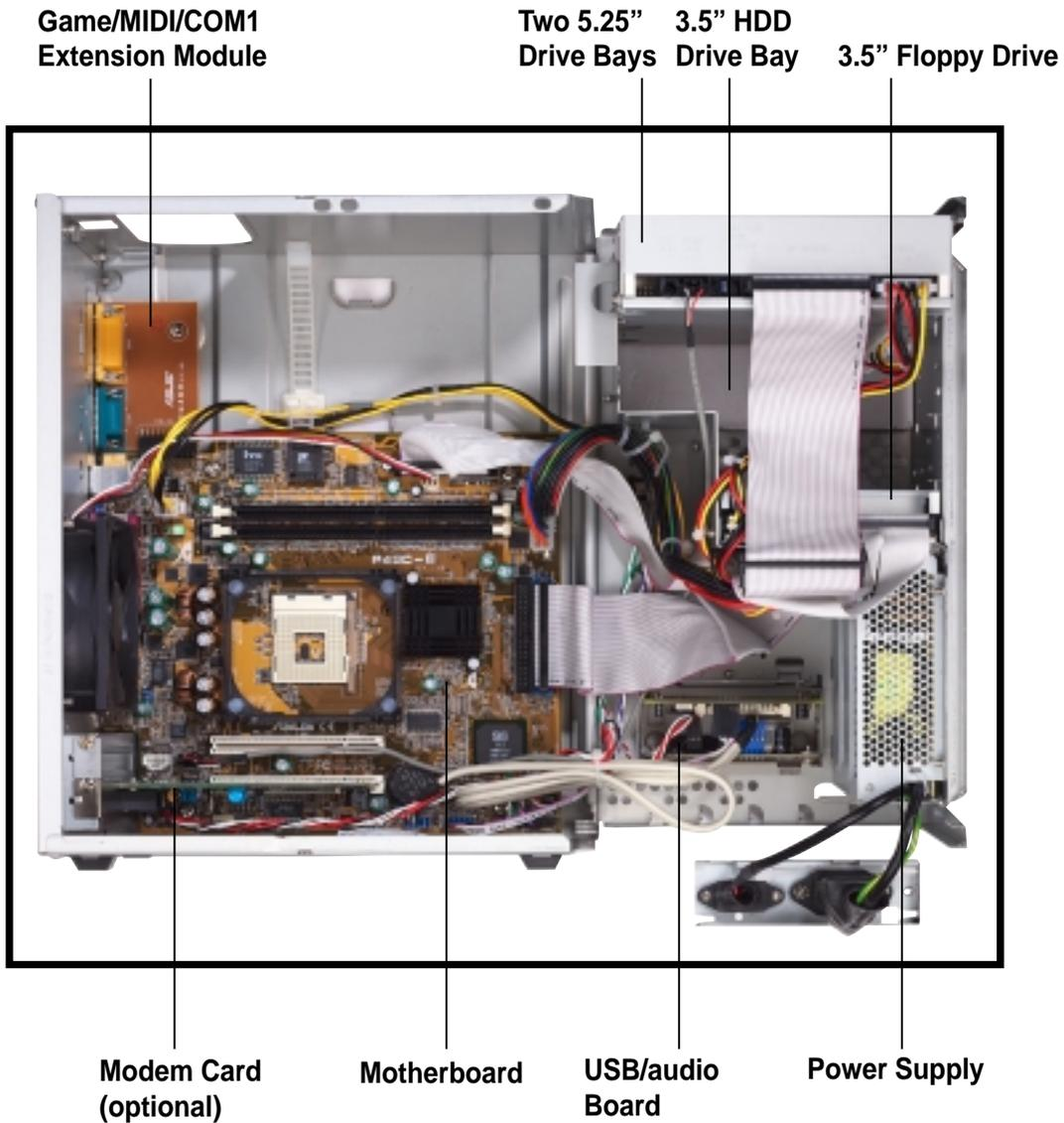

# Chapter 2

This chapter tells how to install components into the barebone system through illustrated step-by-step instructions.

# Basic Installation

## 2.1 Remove the cover

The chassis cover is secured by a thumbscrew located on the rear panel.

Follow these steps to remove the chassis cover.

1. Turn the captive thumbscrew counter-clockwise to release the cover. You don't have to remove the thumbscrew from the chassis.

Thumbscrew



2. Place your hands on both corners of the front panel, just beside the CD-ROM frame. Push on the CD-ROM area with your thumbs until the cover tilts forward.



### TIP

Another way to release the cover is to place your hands underneath the front panel edge, then push the inner chassis with your thumbs while pulling the panel with your other fingers.

3. While supporting the front panel with one hand, place your other hand on the top rear edge of the cover and carefully lift the cover from the chassis.





## 2.2 Detach the drive frame

Follow these steps to detach the drive frame.

1. Place the chassis on a flat surface and turn it on its side.



2. The power socket and voltage selector switch are attached to a metal module secured to the rear panel by a screw. Remove the screw to release the power socket module.

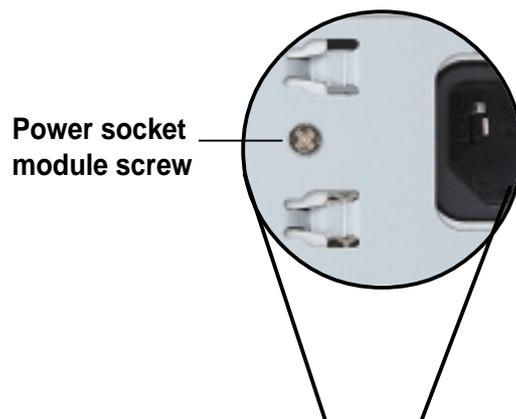

Power socket module



---

### IMPORTANT

You must release the power socket module from the rear panel before detaching the drive frame to avoid breaking the power cable.

---

3. Place your thumb on the right edge of the power socket module, then slide the module to the right until it is completely detached from the rear panel.



4. Unlatch the drive frame by pulling it outward.

Drive frame

Swivel edge

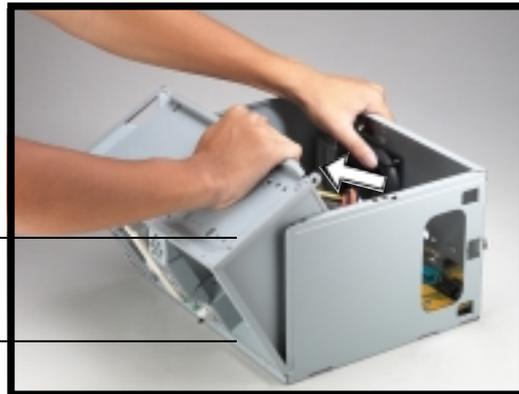

---

#### **NOTE**

The drive frame has a swivel (hinge-like) edge that is attached to the main chassis. It is not necessary to completely detach the drive frame from the chassis when installing components.

---

5. Carefully lay the drive frame alongside the main chassis frame.



## 2.3 Install a CPU

The P4SC-E motherboard comes with a surface mount 478-pin Zero Insertion Force (ZIF) socket. This socket is specifically designed for the Intel® Pentium® 4 478/Northwood Processor.

Follow these steps to install a CPU.

1. Locate the 478-pin CPU socket on the motherboard.

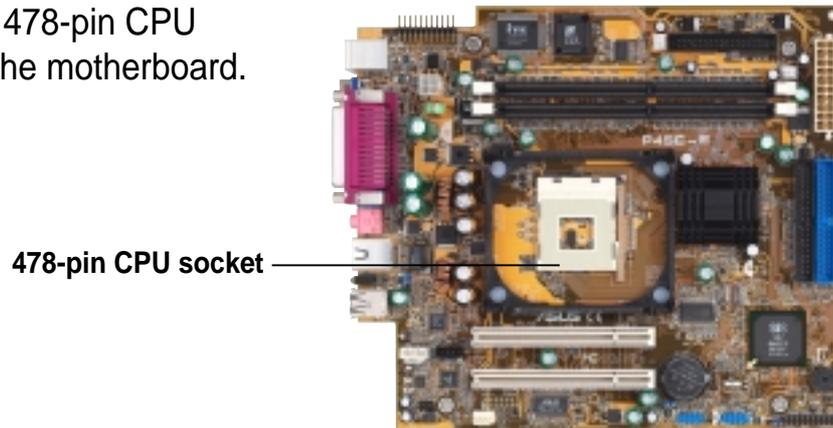

2. Unlock the socket by pressing the lever sideways then lifting it up to a 90°-100° angle.

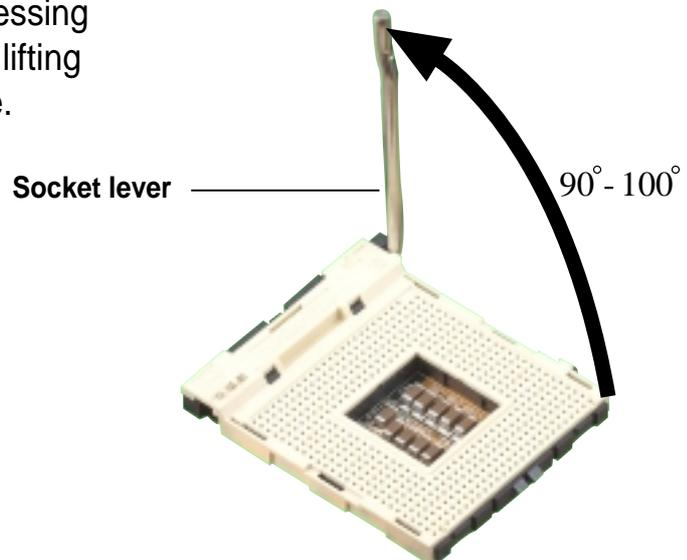

---

### IMPORTANT

Make sure that the socket lever is lifted up to 90°-100° angle, otherwise the CPU does not fit in completely.

---

3. Position the CPU above the socket such that its marked corner (gold mark) matches the base of the socket lever.
4. Carefully insert the CPU into the socket until it fits in place.

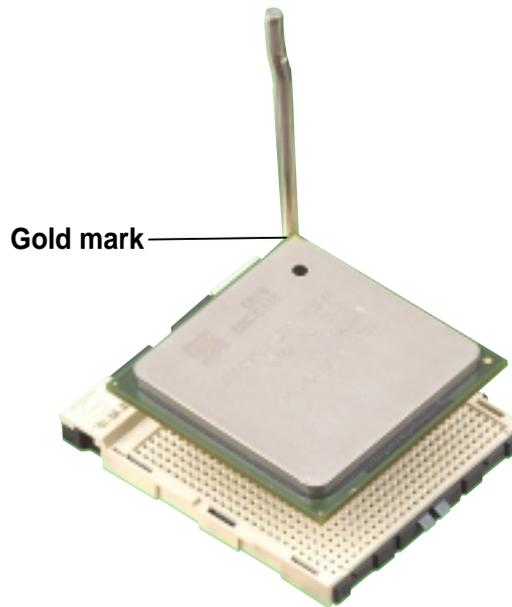

---

**CAUTION**

The CPU fits only in one correct orientation. DO NOT force the CPU into the socket to prevent bending the pins and damaging the CPU!

---

5. When the CPU is in place, press it firmly on the socket while you push down the socket lever to secure the CPU. The lever clicks on the side tab to indicate that it is locked.



## 2.4 Install the CPU heatsink and fan

The Intel® Pentium® 4 478/Northwood Processor requires a specially designed heatsink and fan assembly to ensure optimum thermal condition and performance.

When you buy a boxed Intel Pentium 4 478/Northwood Processor, the package usually includes the heatsink and fan assembly.

---

### IMPORTANT

Make sure that you use only Intel certified CPU heatsink and fan.

---

Follow these steps to install the CPU heatsink and fan.

1. Position the fan heatsink assembly on top of the installed CPU such that the fan cable is nearest the CPU fan connector on the motherboard (marked CPU\_FAN1).

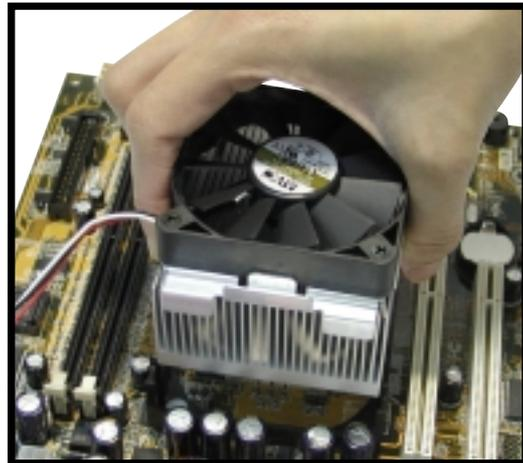

2. Align one retention bracket with the rail on the side of the heatsink. Orient the bracket such that the locking lever is on the side of the PCI slots.
3. Snap the hook of the metal retention bracket into the hole of the retention module.
4. Follow steps 2 and 3 to attach the second retention bracket.

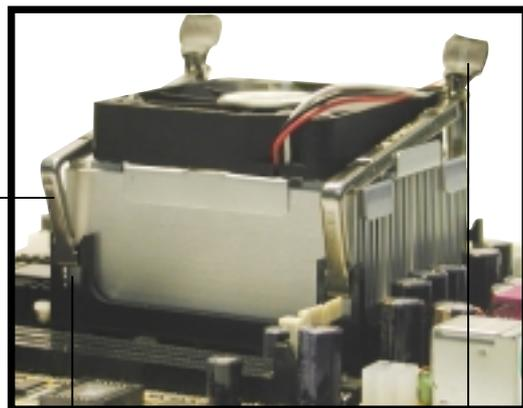

Retention bracket

Hole on the retention module

Locking lever

- Carefully press down the locking lever on the other side of the bracket and hook its end into the hole of the retention module to secure the fan heatsink assembly in place.
- Follow step 5 to lock the second bracket.

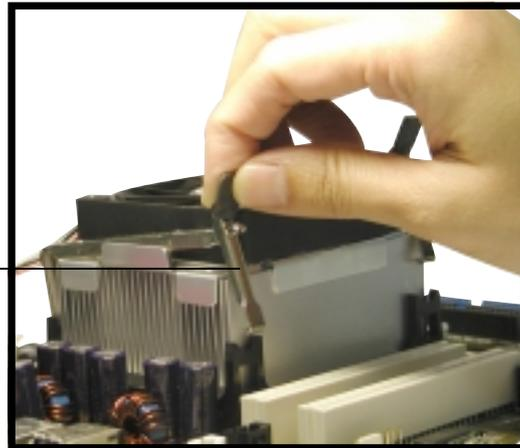

Locking lever

- Connect the CPU fan cable from the assembly to the fan connector labeled CPU\_FAN1.

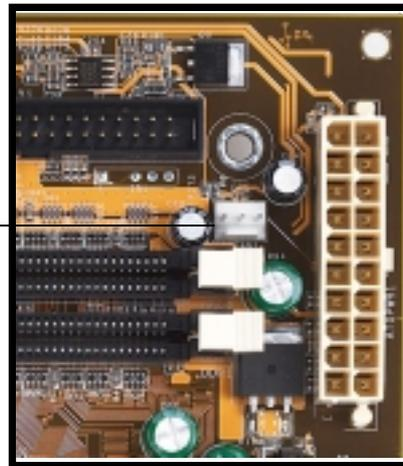

CPU fan connector  
(CPU\_FAN1)

---

#### NOTE

Your boxed Intel Pentium 4 478/Northwood Processor package may come with installation instructions for the CPU and fan heatsink assembly. If the instructions in this section do not match the documentation for the CPU or fan heatsink, follow the latter.

---

## 2.5 Install system memory

The motherboard comes with two Double Data Rate (DDR) Dual Inline Memory Module (DIMM) sockets. These sockets support up to 2GB system memory using unbuffered ECC or non-ECC PC2700/1600/2100 DIMMs.

Follow these steps to install a DDR DIMM.

1. Locate the two DIMM sockets on the motherboard.

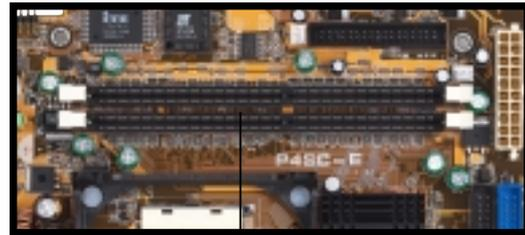

DDR DIMM sockets

2. Unlock a socket by pressing the retaining clips outward.
3. Align a DIMM on the socket such that the notch on the DIMM matches the break on the socket.

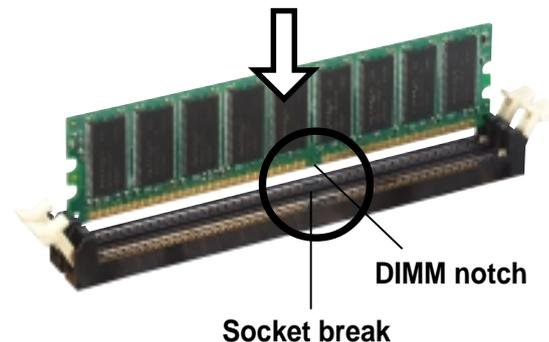

4. Firmly insert the DIMM into the socket until the retaining clips snap back in place and the DIMM is properly seated.

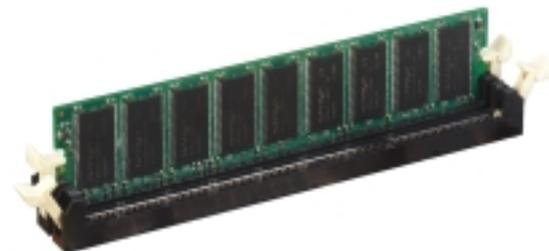

---

### CAUTION

A DDR DIMM is keyed with a notch so that it fits in only one direction. DO NOT force a DIMM into a socket to avoid damaging the DIMM.

---

## 2.6 Install a hard disk drive

The chassis has one 3.5-inch hard disk drive (HDD) bay right under the 5.25-inch bay. The following figures show the internal and external views of the HDD bay location.

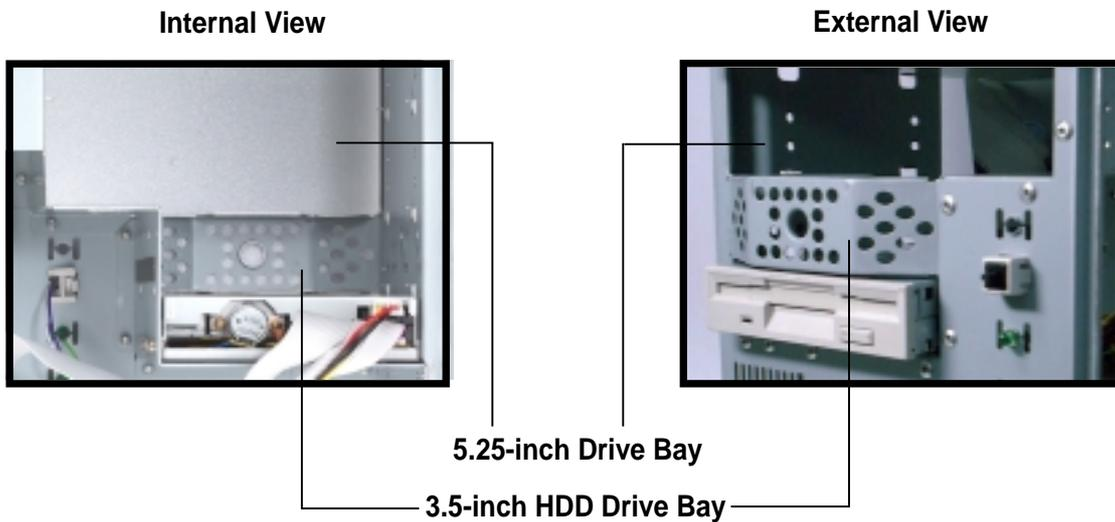

Follow these steps to install an IDE HDD.

1. Place the chassis upright.
2. With the HDD label side up, carefully insert the drive into the 3.5-inch bay.

HDD label side



3. Push the drive into the bay until its screw holes align with the holes on the bay marked HDD.
4. Secure the drive with two screws on each side of the bay.



HDD screws



5. Connect a power cable from the power supply to the power connector at the back of the HDD. Use the cable with the white connector labeled P3.
6. Connect one end of the IDE hard disk ribbon cable to the IDE interface at the back of the HDD, matching the red stripe on the cable with Pin 1 on the IDE interface.



Red Stripe to Pin 1  
IDE Ribbon Cable      Power Cable (P3)

7. Connect the other end of the IDE ribbon cable to the primary IDE connector (blue connector labeled PRI\_IDE1) on the motherboard.

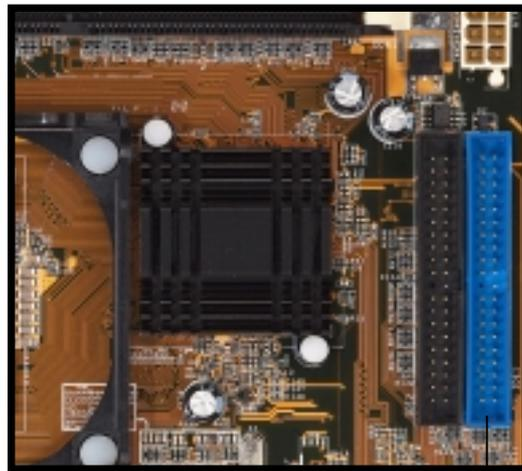

Primary IDE connector  
(PRI\_IDE1)

## 2.7 Install a CD-ROM drive

A CD-ROM drive is an optional item in this barebone system. Refer to the instructions in this section if you acquired a model without a CD-ROM.

Follow these steps to install a CD-ROM drive.

1. Place the chassis upright.
2. Insert the CD-ROM drive into the upper 5.25-inch drive bay.



5.25-inch drive bay

3. Carefully push the CD-ROM drive into the bay until its screw holes align with the holes (marked 1) on the bay as shown.
4. Secure the CD-ROM with two screws on each side of the bay.

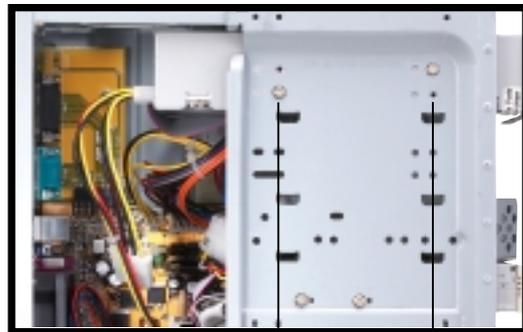

CD-ROM screws

5. Connect a power cable from the power supply to the power connector at the back of the CD-ROM. Use the cable with the white connector labeled P1.

6. Connect one end of the IDE ribbon cable to the IDE interface at the back of the CD-ROM, matching the red stripe on the cable with Pin 1 on the IDE interface.

7. Connect one end of the CD-ROM audio cable to the 4-pin connector at the back of the CD-ROM.

8. Connect the other end of the IDE ribbon cable to the secondary IDE connector (black connector labeled PRI\_IDE2) on the motherboard.

9. Connect the other end of the audio cable to the black 4-pin connector labeled CD on the motherboard.



CD-ROM Audio Cable

IDE Ribbon Cable

Red Stripe to Pin 1

Power Cable (P1)

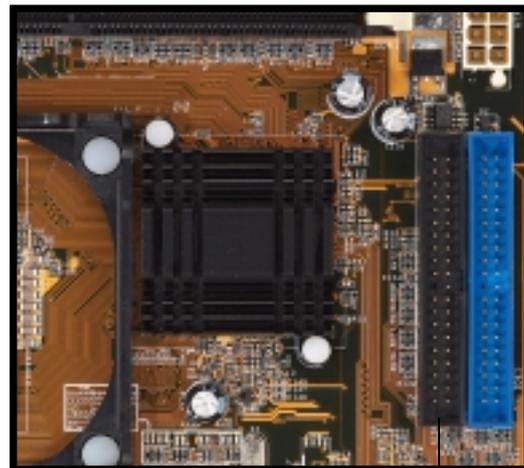

Secondary IDE connector  
(PRI\_IDE2)

CD-ROM Connector  
(CD1)

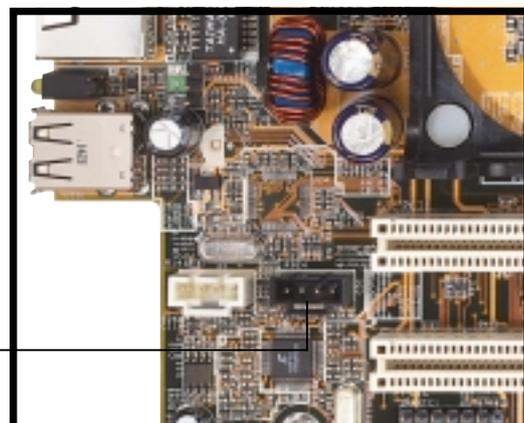

## 2.8 Install a PCI expansion card

The motherboard has two 32-bit PCI slots. If you wish to install a PCI card, follow the instructions in this section.

The figure on the right shows a sample PCI network card that you can install on the PCI slot.

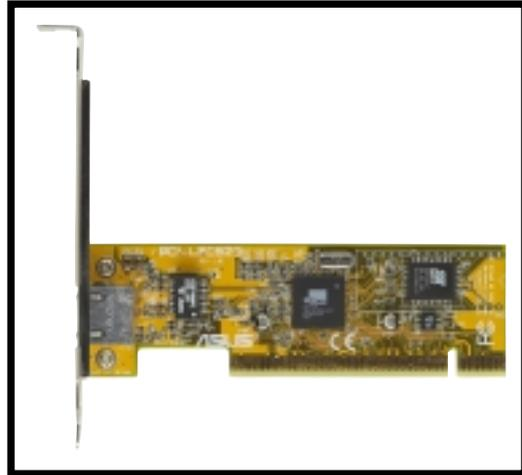

Follow these steps to install a PCI expansion card.

1. Place the chassis on its side.
2. Remove the metal bracket cover opposite the PCI slot that you wish to use.
3. Align the PCI card golden fingers to the PCI slot and its metal bracket to the slot opening on the chassis.
4. Press the card firmly until it is properly seated on the slot.
5. Secure the card to the chassis with a bracket screw.



Slot Opening

PCI Slot 1 (PCI1)

PCI Slot 2 (PCI2)

---

### NOTE

If your system came with the optional modem card, one PCI slot is already occupied.

---

## 2.9 Re-connect cables

You may have disconnected some cables when you were installing components. You must re-connect these cables before you replace the chassis cover.

### 2.9.1 LED cables

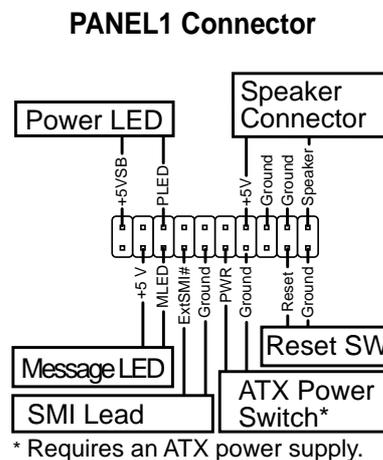
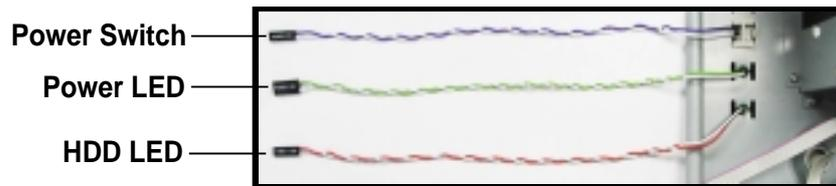

- Connect the **power switch** and **power LED** cables to their respective leads in the PANEL1 connector on the motherboard.
- Connect the **HDD LED** cable to the 2-pin lead marked IDE\_LED1.

## 2.9.2 UAEX and USB-CF extension modules

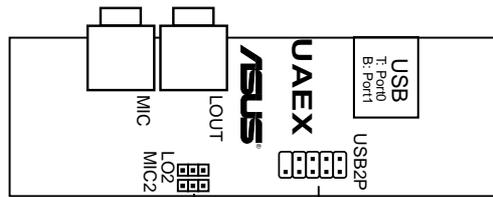

Connect to MIC\_LOUT1 connector on the motherboard

Connect to USB\_34 connector on the motherboard

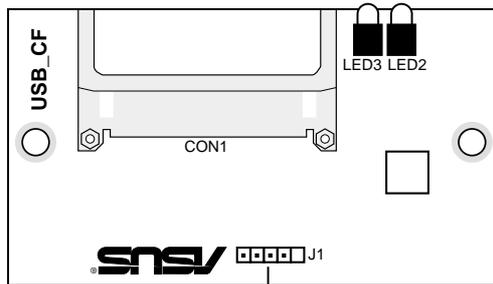

Connect to USB\_56 connector on the motherboard

### *Connector locations on the motherboard*



USB\_34    USB\_56

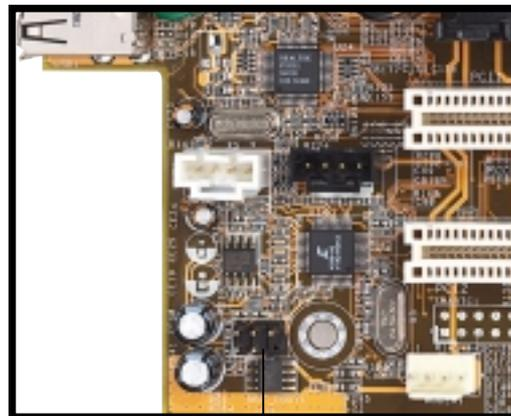

MIC\_LOUT1 connector  
(for Microphone/Line Out Cable)

## 2.10 Replace the cover

After you have installed all the internal components and you have connected all the necessary cables, you are now ready to put the system back together.

Follow these steps to re-assemble the system.

1. With the chassis lying on its side, hook the swivel edge of the drive frame to the main chassis.
2. Sway the drive frame inward until it fits completely. The protruding tabs on both ends of the drive frame should snap perfectly to the chassis edge.



Protruding Tab

3. Turn the chassis upright.
4. Place the cover over the chassis leaving about two inches from the rear panel.



5. Fit the rail tabs on the sides and bottom of the cover to the edges of the chassis.

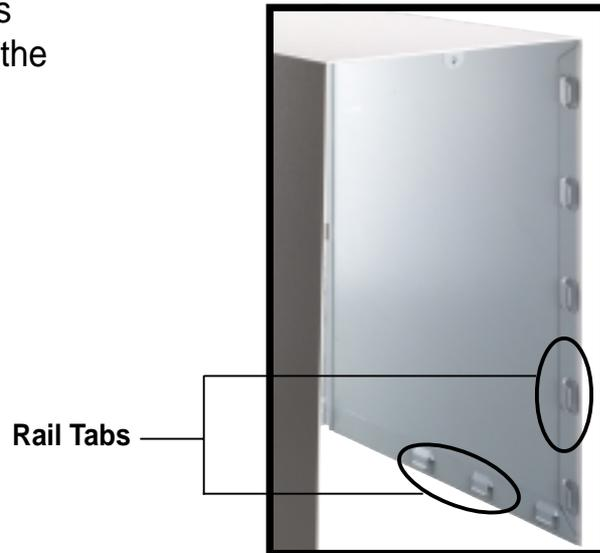

6. Push the cover towards the rear until it fits. The locking tab snaps into the hole on the chassis indicating that the cover is in place.

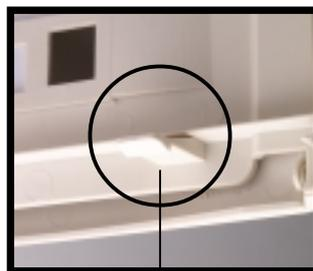

Locking Tab



Locking Tab Hole

---

**IMPORTANT**

Firmly push the cover to ensure that it is fully engaged to the chassis.

---

7. Lock the cover with the captive thumbscrew on the rear panel.



## 2.11 Connect External Devices

The figure below shows the specific connectors and devices that you can connect to the rear panel ports.

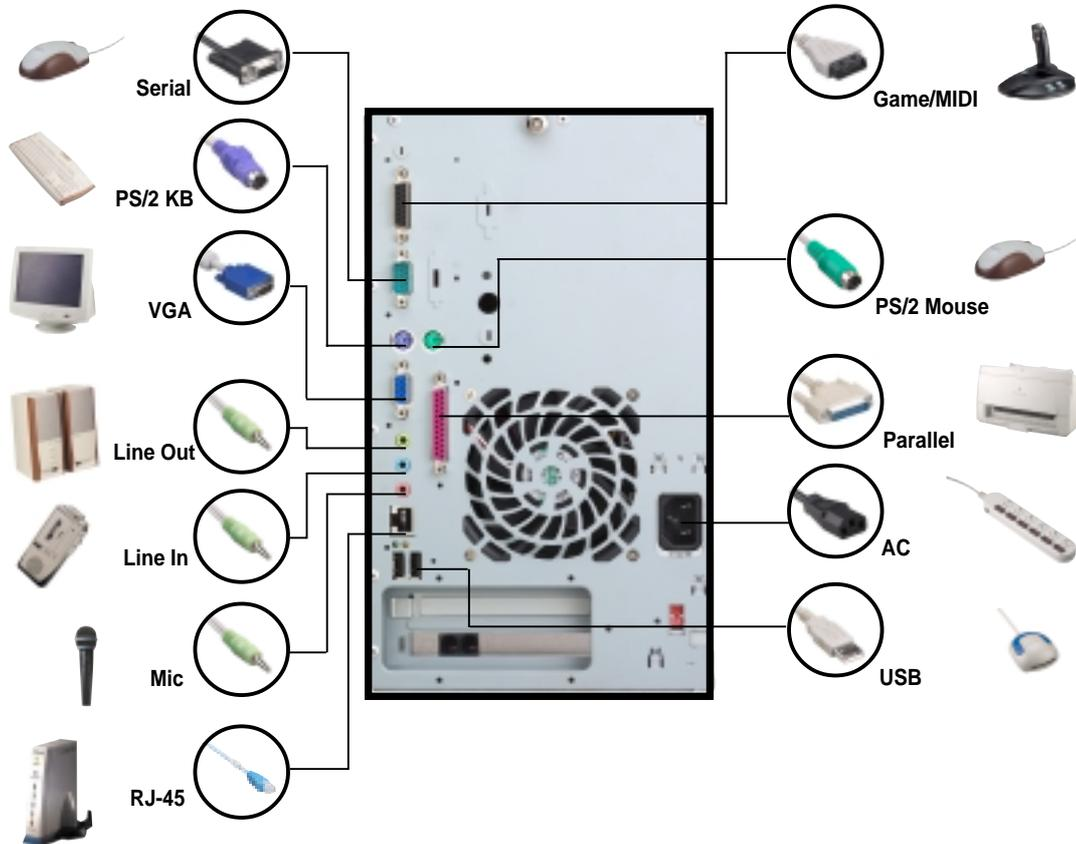

## 2.12 Power Supply Specifications

### 2.12.1 Input Characteristics

<b>Input Voltage Range</b>	<b>Min</b>	<b>Nom</b>	<b>Max</b>
Range 1	90V	115V	135V
Range 2	180V	230V	265V
<b>Input Frequency Range</b>	47 Hz to 63 Hz		
<b>Maximum Input ac Current</b>	4A max. at 115Vac 2A max. at 230Vac, maximum load		
<b>Inrush Current</b>	90A max. at 115Vac, full load cold start at 25°C		
<b>Efficiency</b>	70% min. at nominal input, maximum load		

### 2.12.2 Output Characteristics

<b>Output Voltage</b>	<b>Load Range</b>		<b>Regulation</b>		<b>Ripple</b>
	<b>Min</b>	<b>Max</b>	<b>Min</b>	<b>Max</b>	<b>Max</b>
+5V	0.5A	4.0A	-5%	+5%	50mV <sub>p-p</sub>
+12V	0.45A	9.5A	-5%	+5%	120mV <sub>p-p</sub>
-12V	0A	0.2A	-10%	+10%	120mV <sub>p-p</sub>
+5VSB	0.05A	1.5A	-5%	+5%	50mV <sub>p-p</sub>
+3V3	1A	8.0A	-5%	+5%	50mV <sub>p-p</sub>

### 2.12.3 Over-Voltage Protection (OVP)

<b>Output Voltage</b>	<b>Maximum Voltage</b>
+5V	6.5V
+12V	15.6V
+3.3V	4.3V

#### NOTE

The power supply will shut down and latch off for shorting +5V, +12V, -12V, or +3.3V. By shorting +5VSB, the power supply can latch down or automatically recover when the fault condition is removed

# Chapter 3

This chapter gives information about the ASUS P4SC-E motherboard that came with the system. This chapter includes the motherboard layout, jumper settings, and connector locations. It also includes information on the USB/audio board located on the front panel.

---

## **IMPORTANT**

The ASUS Terminator P4 533 barebone system is designed to support a motherboard that measures 23 cm (9.06 in) x 22.4 cm (8.82 in). It is not recommended to install any motherboard of other sizes. If you need to replace the original motherboard that came with the system, make sure that it fits into the chassis and that the I/O connectors correspond to the openings on the rear panel.

---

# Motherboard Info

## 3.1 Introduction

The ASUS P4SC-E motherboard comes already installed in the ASUS Terminator P4 533 barebone system. For future upgrades or system reconfiguration, this chapter provides technical information about the motherboard.

## 3.2 Motherboard components

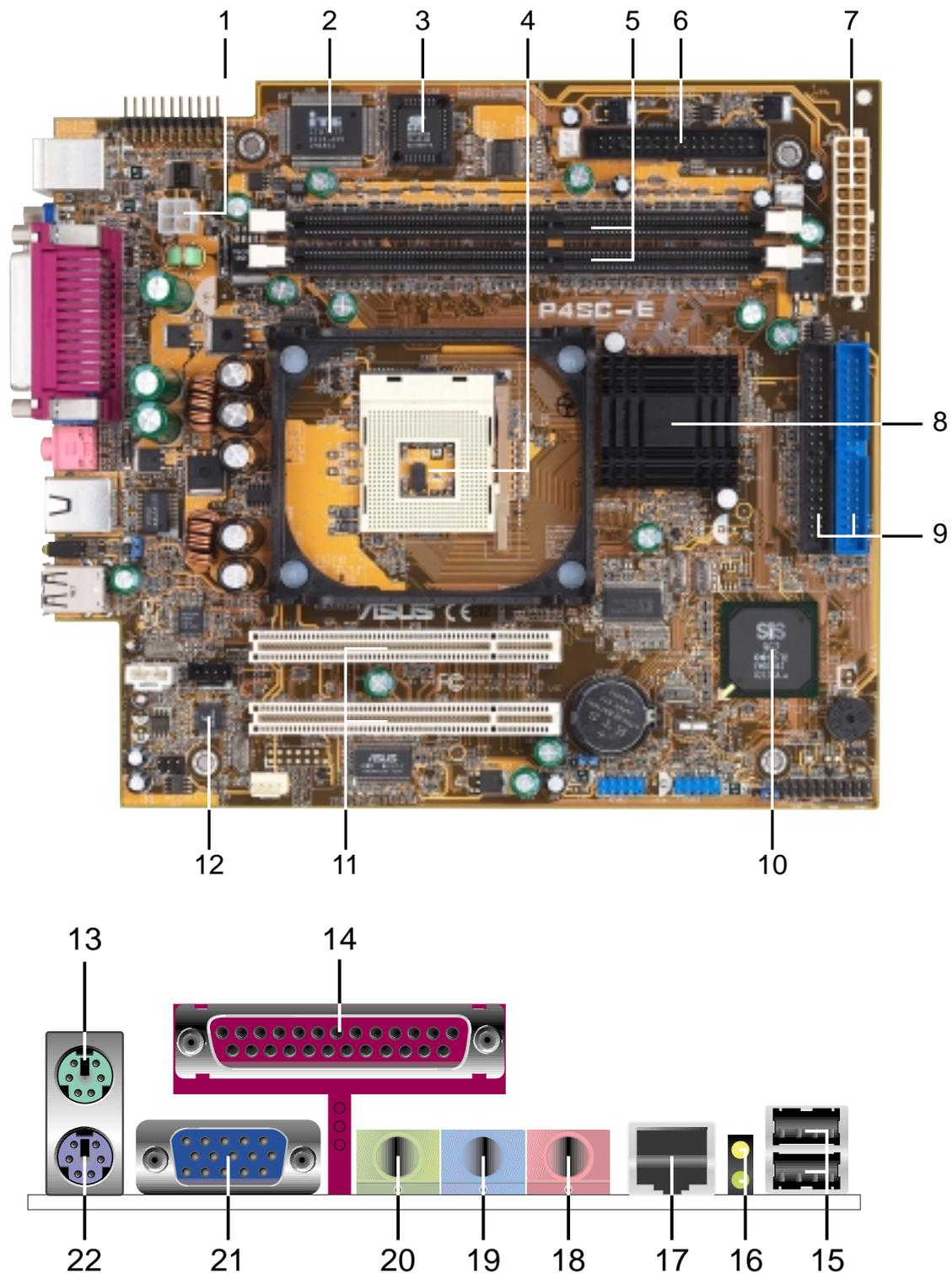

- 1 ATX 12V connector.** This power connector connects the 4-pin 12V plug from the ATX 12V power supply.
- 2 Super I/O chipset.** This Low Pin Count (LPC) interface provides the commonly used Super I/O functionality. The chipset supports a high-performance floppy disk controller for a 360K/720K/1.44M/2.88M floppy disk drive, a multi-mode parallel port, two standard compatible UARTs, a Standard Infrared (SIR), one MPU-401 UART mode compatible MIDI/game port, and a Flash ROM interface.
- 3 Flash ROM.** This 2Mb firmware contains the programmable BIOS program.
- 4 CPU socket.** A 478-pin surface mount, Zero Insertion Force (ZIF) socket for the Intel® Pentium® 4 478/Northwood Processor with 533/400 MHz system bus that allows 4.3GB/s and 3.2GB/s data transfer rates, respectively.
- 5 DDR DIMM sockets.** These two 184-pin DIMM sockets support up to 2GB using unbuffered ECC or non-ECC PC2700/2100/1600 DDR DIMMs.
- 6 Floppy disk connector.** This connector connects the provided ribbon cable for the floppy disk drive. One side of the connector is slotted to prevent incorrect insertion of the floppy disk cable.
- 7 ATX power connector.** This 20-pin connector connects to an ATX 12V power supply. The power supply must have at least 1A on the +5V standby lead (+5VSB).
- 8 North bridge controller.** This SiS651 controller integrates a high performance host interface for the Intel® Pentium® 4 processor, a memory controller, an AGP interface, and SiS MuTIOL technology.
- 9 IDE connectors.** These dual-channel bus master IDE connectors support up to four Ultra DMA133/100/66, PIO Modes 3 & 4 IDE devices. Both the primary (blue) and secondary (black) connectors are slotted to prevent incorrect insertion of the IDE ribbon cable.
- 10 South bridge controller.** Referred to as the SiS962L MuTIOL Media I/O, this controller integrates the audio controller with AC'97 Interface, Ethernet MAC, Dual Universal Serial Bus Host controllers, IDE Master/Slave controllers, and the MuTIOL Connect to PCI Bridge.

- 11** **PCI slots.** These two 32-bit PCI 2.2 expansion slots support bus master PCI cards like SCSI or LAN cards with 133MB/s maximum throughput.
- 12** **Audio/Modem CODEC.** This audio CODEC is AC '97 compliant.
- 13** **PS/2 mouse port.** This green 6-pin connector is for a PS/2 mouse.
- 14** **Parallel port.** This 25-pin port connects a parallel printer, a scanner, or other devices.
- 15** **USB ports.** These two 4-pin Universal Serial Bus (USB) ports are available for connecting USB devices such as a mouse and PDA.
- 16** **LAN activity LEDs.** These LEDs indicate an active network connection.
- 17** **RJ-45 port.** This port allows connection to a Local Area Network (LAN) through a network hub.
- 18** **Microphone jack.** This Mic (pink) jack connects a microphone.
- 19** **Line In jack.** This Line In (light blue) jack connects a tape player or other audio sources.
- 20** **Line Out jack.** This Line Out (lime) jack connects a headphone or a speaker.
- 21** **Video port.** This port connects a VGA monitor.
- 22** **PS/2 keyboard port.** This purple 6-pin connector is for a PS/2 keyboard.

# 3.3 Motherboard layout

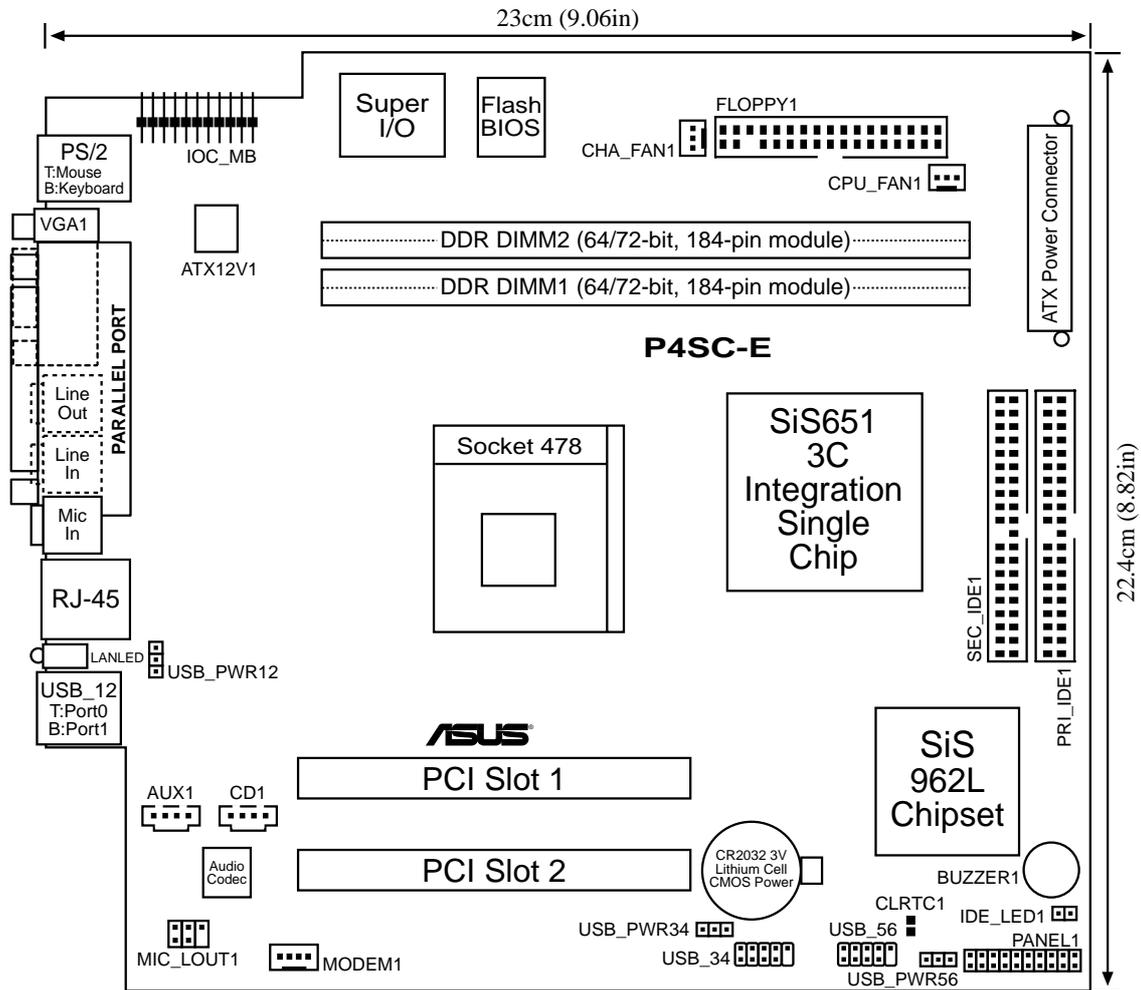

## 3.4 Central Processing Unit (CPU)

The motherboard comes with a surface mount 478-pin Zero Insertion Force (ZIF) socket. This socket is specifically designed for the Intel® Pentium® 4 478/Northwood Processor.

The Intel Pentium 4 Processor in the 478-pin package uses the Flip-Chip Pin Grid Array 2 (FC-PGA2) package technology, and includes the Intel® NetBurst™ micro-architecture. The Intel NetBurst micro-architecture features the hyper-pipelined technology, rapid execution engine, 533/400MHz system bus, and execution trace cache. Together, these attributes improve system performance by allowing higher processor frequencies, faster execution of integer instructions, and a data transfer rate of 4.3GB/s and 3.2GB/s.

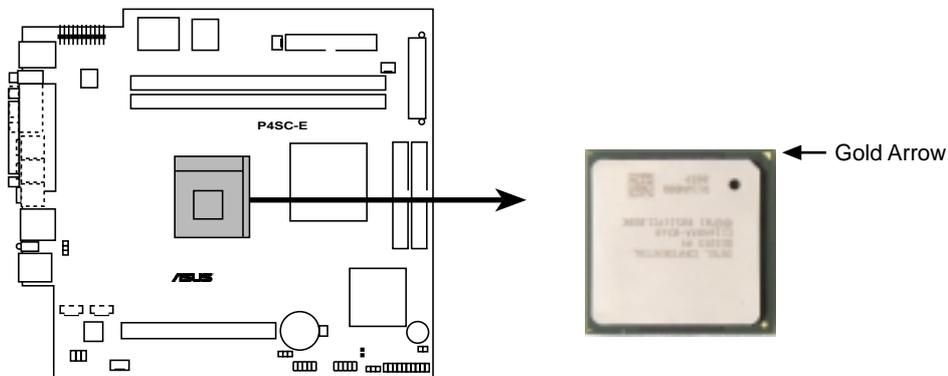

**P4SC-E Socket 478**

---

### NOTE

Refer to sections “2.3 Install a CPU” and “2.4 Install the CPU heatsink and fan” for instructions on installing the Intel Pentium 4 CPU and the heatsink/fan assembly.

---



## 3.5 System memory

The motherboard has two Double Data Rate (DDR) DIMM sockets that supports up to 2GB unbuffered non-ECC PC2700/2100/1600 DDR DIMMs.

A DDR DIMM has the same physical dimensions as an SDR DIMM, but it has a 184-pin footprint compared to the 168-pin of the SDR DIMM. Also, a DDR DIMM is single notched while an SDR DIMM is double notched. Therefore, a DDR DIMM is not backward compatible with SDR, and should be installed only in a socket specially designed for DDR DIMMs.

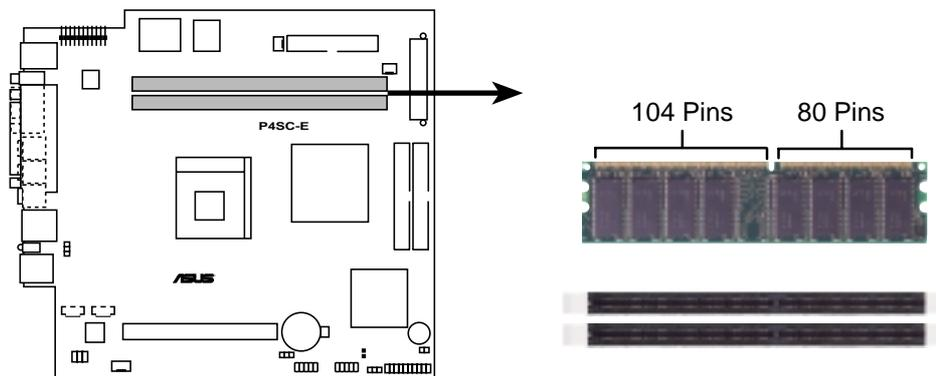

**P4SC-E 184-Pin DDR DIMM Sockets**

### 3.5.1 Memory configurations

You may install any DDR DIMMs with 64MB, 128MB, 256MB, 512MB, and 1GB densities into the three DIMM sockets.

Use the following combinations to install DDR DIMMs.

DIMM Location	184-pin DDR DIMM	Total Memory
Socket 1 (Rows 0&1)	64MB, 128MB, 256MB, 512MB, 1GB x1	=
Socket 2 (Rows 2&3)	64MB, 128MB, 256MB, 512MB, 1GB x1	=
<b>Total system memory (Max. 2GB)</b>		<b>=</b>

#### NOTE

Refer to section “2.5 Install system memory” for instructions on installing DDR DIMMs.

## 3.6 Expansion slots

In the future, you may need to install expansion cards. The motherboard has two PCI slots.

### 3.6.1 Configuring an expansion card

After physically installing the expansion card, configure the card by adjusting the software settings.

1. Turn on the system and change the necessary BIOS settings, if any. See Chapter 4 for information on BIOS setup.
2. Assign an IRQ to the card. Refer to the tables below.
3. Install the software drivers for the expansion card.

### 3.6.2 Standard Interrupt Assignments

IRQ	Priority	Standard Function
0	1	System Timer
1	2	Keyboard Controller
2	N/A	Programmable Interrupt
3*	11	Communications Port (COM2)
4*	12	Communications Port (COM1)
5*	13	Sound Card (sometimes LPT2)
6	14	Floppy Disk Controller
7*	15	Printer Port (LPT1)
8	3	System CMOS/Real Time Clock
9*	4	ACPI Mode when used
10*	5	IRQ Holder for PCI Steering
11*	6	IRQ Holder for PCI Steering
12*	7	PS/2 Compatible Mouse Port
13	8	Numeric Data Processor
14*	9	Primary IDE Channel
15*	10	Secondary IDE Channel

\*These IRQs are usually available for ISA or PCI devices.

### 3.6.3 IRQ assignments for this motherboard

	A	B	C	D	E	F	G	H
PCI slot 1	—	used	—	—	—	—	—	—
PCI slot 2	—	—	used	—	—	—	—	—
Onboard Audio	—	—	—	—	—	used	—	—
Onboard LAN	—	—	—	—	—	—	used	—

## 3.7 Jumpers

This section describes and illustrates the jumpers on the motherboard.

### 1. USB device wake-up (3-pin USB\_PWR12, USB\_PWR34, USB\_PWR56)

Set these jumpers to +5V to wake up the computer from S1 sleep mode (CPU stopped, DRAM refreshed, system running in low power mode) using the connected USB devices. Set to +5VSB to wake up from S3 sleep mode (no power to CPU, DRAM in slow refresh, power supply in reduced power mode).

The USB\_PWR12 jumper is for the rear USB ports. The USB\_PWR34 and USB\_PWR56 jumpers are for the internal USB headers that connect to the front USB ports and USB-CF slot.

---

#### NOTES

This feature requires a power supply that can provide at least 1A on the +5VSB lead when these jumpers are set to +5VSB. Otherwise, the system does not power up.

The total current consumed must NOT exceed the power supply capability (+5VSB) whether under normal condition or in sleep mode.

---

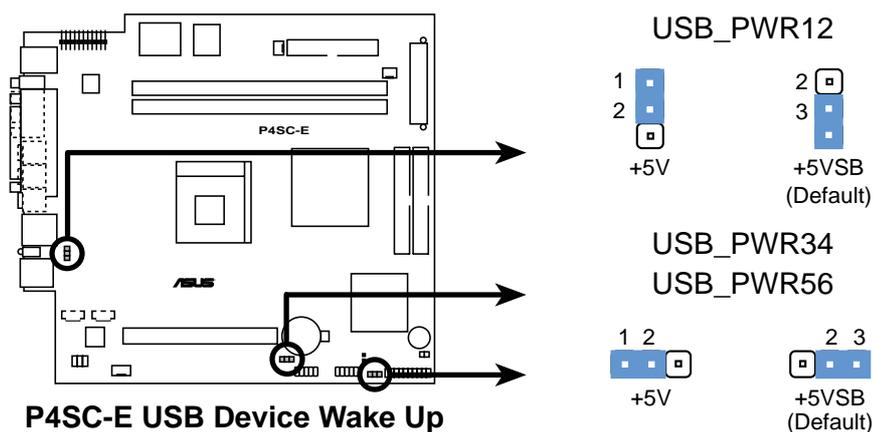

## 2. Clear RTC RAM (CLRTC1)

These solder points allow you to clear the Real Time Clock (RTC) RAM in CMOS. You can clear the CMOS memory of date, time, and system setup parameters by erasing the CMOS RTC RAM data. The RAM data in CMOS, that include system setup information such as system passwords, is powered by the onboard button cell battery.

To erase the RTC RAM:

1. Turn OFF the computer and unplug the power cord.
2. Remove the battery.
3. Short the solder points.
4. Re-install the battery.
5. Plug the power cord and turn ON the computer.
6. Hold down the <Del> key during the boot process and enter BIOS setup to re-enter data.

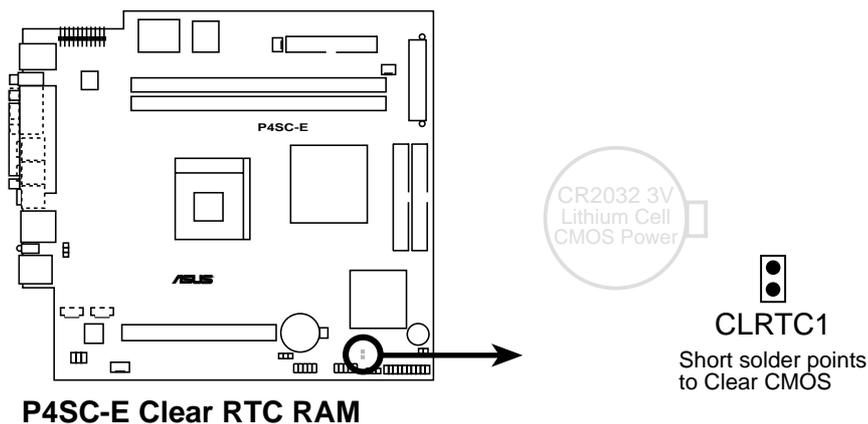

## 3.8 Connectors

This section describes and illustrates the connectors on the motherboard.

### 1. IDE connectors (40-1 pin PRI\_IDE1, SEC\_IDE1)

This connector supports the provided UltraDMA/133/100/66 IDE hard disk ribbon cable. Connect the cable's blue connector to the primary (recommended) or secondary IDE connector, then connect the gray connector to the UltraDMA/133/100/66 slave device (hard disk drive) and the black connector to the UltraDMA/133/100/66 master device. It is recommended that you connect non-UltraDMA/133/100/66 devices to the secondary IDE connector. If you install two hard disks, you must configure the second drive as a slave device by setting its jumper accordingly. Refer to the hard disk documentation for the jumper settings. BIOS supports specific device bootup. If you have more than two UltraDMA/133/100/66 devices, purchase another UltraDMA/133/100/66 cable. You may configure two hard disks to be both master devices with two ribbon cables – one for the primary IDE connector and another for the secondary IDE connector.

---

#### NOTES

Pin 20 on each IDE connector is removed to match the covered hole on the UltraDMA cable connector. This prevents incorrect orientation when you connect the cables.

For UltraDMA/133/100/66 IDE devices, use an 80-conductor IDE cable.

---

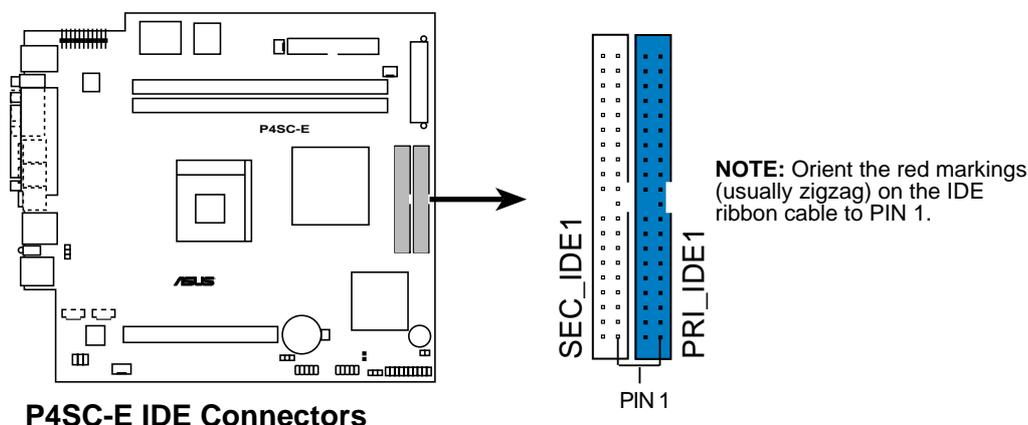

## 2. Floppy disk drive connector (34-1 pin FLOPPY1)

This connector supports the provided floppy drive ribbon cable. After connecting one end to the motherboard, connect the other end to the floppy drive. (Pin 5 is removed to prevent incorrect insertion when using ribbon cables with pin 5 plug).

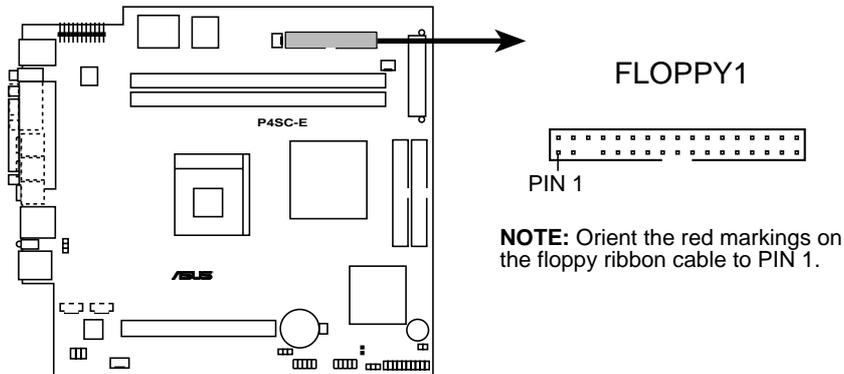

**P4SC-E Floppy Disk Drive Connector**

## 3. Hard disk activity LED (2-pin IDE\_LED1)

This connector supplies power to the hard disk activity LED. The read or write activities of any device connected to the primary or secondary IDE connector cause this LED to light up.

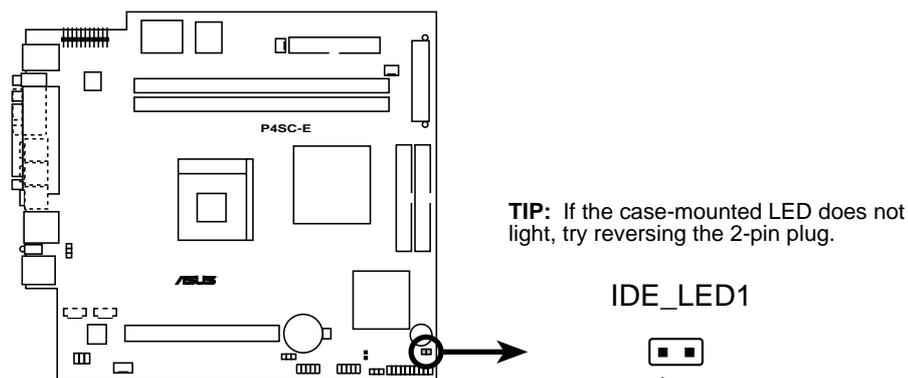

**P4SC-E IDE Activity LED**

#### 4. ATX power connectors (20-pin ATXPWR, 4-pin ATX +12V)

These connectors connect to an ATX 12V power supply. The plugs from the power supply are designed to fit these connectors in only one orientation. Find the proper orientation and push down firmly until the connectors completely fit.

In addition to the 20-pin ATXPWR connector, this motherboard requires that you connect the 4-pin ATX +12V power plug to provide sufficient power to the CPU.

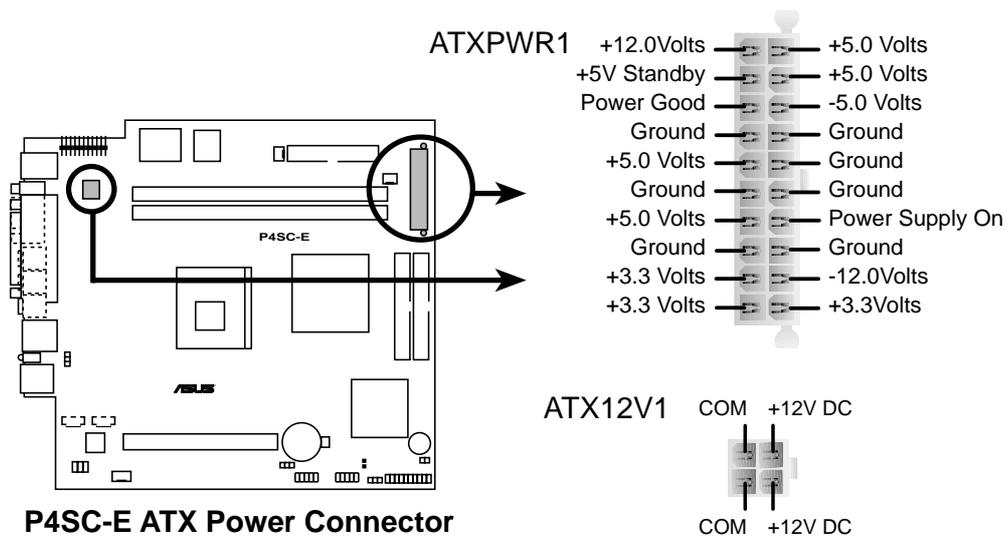

#### IMPORTANT

If you will need to replace the power supply in the future, make sure that your new ATX 12V power supply can provide 8A on the +12V lead and at least 1A on the +5-volt standby lead (+5VSB). The minimum recommended wattage is 230W, or 300W for a fully configured system. The system may become unstable and may experience difficulty powering up if the power supply is inadequate.

## 5. CPU, Chassis, and Power Fan Connectors (3-pin CPU\_FAN1, CHA\_FAN1)

The three fan connectors support cooling fans of 350mA (4.2 Watts) or a total of 1A (12W) at +12V. Orient the fans so that the heat sink fins allow air flow to go across the onboard heat sinks instead of the expansion slots. The fan wiring and plug may vary depending on the fan manufacturer. Connect the fan cable to the connector matching the black wire to the ground pin.

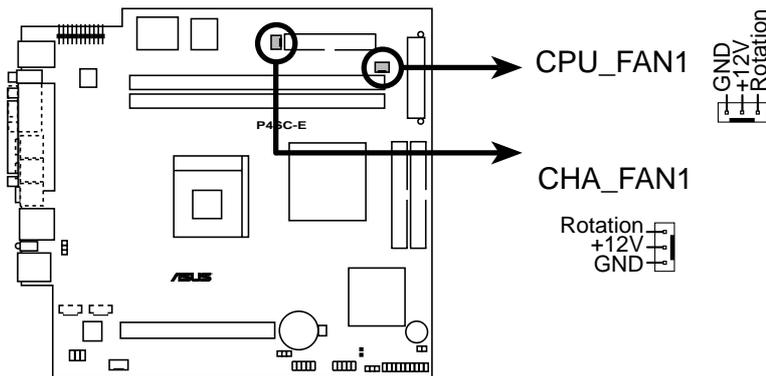

**P4SC-E 12-Volt Cooling Fan Power**

---

### IMPORTANT

Do not forget to connect the fan cables to the fan connectors. Lack of sufficient air flow within the system may damage the motherboard components. These are not jumpers! DO NOT place jumper caps on the fan connectors!

---



## 6. USB headers (10-1 pin USB2)

The USB\_34 header is connected to the USB2P connector in the UAEX extension module on the front panel for two additional USB 2.0 ports.

The USB\_56 header (pins 6 to 10) is connected to the J1 connector on the USB\_CF extension module on the front panel to support the Compact Flash card reader.

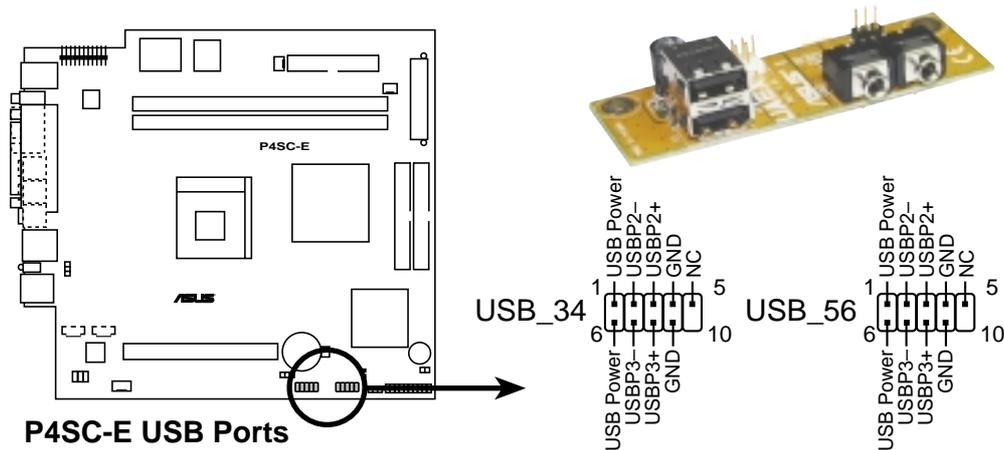

## 7. Internal audio connectors (4-pin AUX1, CD1, MODEM1)

These connectors allow you to receive stereo audio input from sound sources such as a CD-ROM, TV tuner, or MPEG card. The MODEM connector allows the onboard audio to interface with a voice modem card with a similar connector. It also allows the sharing of mono\_in (such as a phone) and a mono\_out (such as a speaker) between the audio and a voice modem card.

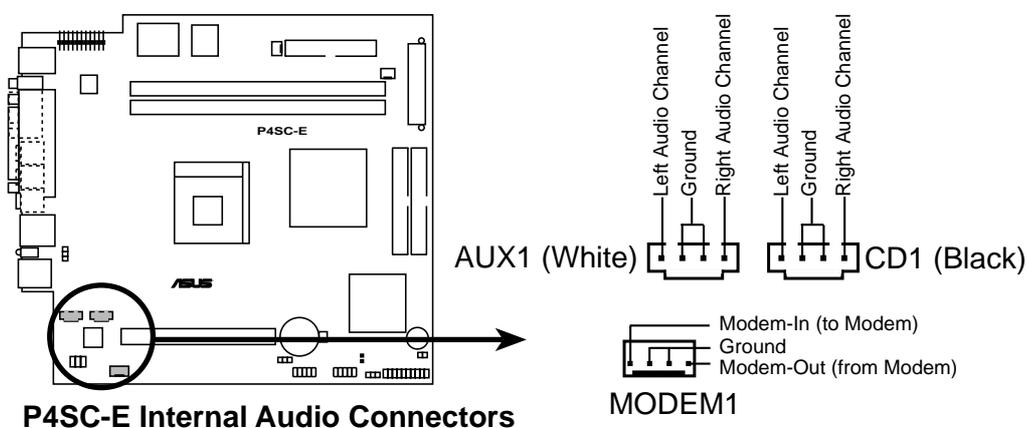

## 8. Front panel audio connectors (5-1 pin MIC\_LOUT1)

This connector connects to a front panel audio module using an audio cable. If your chassis has this audio module, you may conveniently connect a microphone and a speaker/headphone on the front panel.

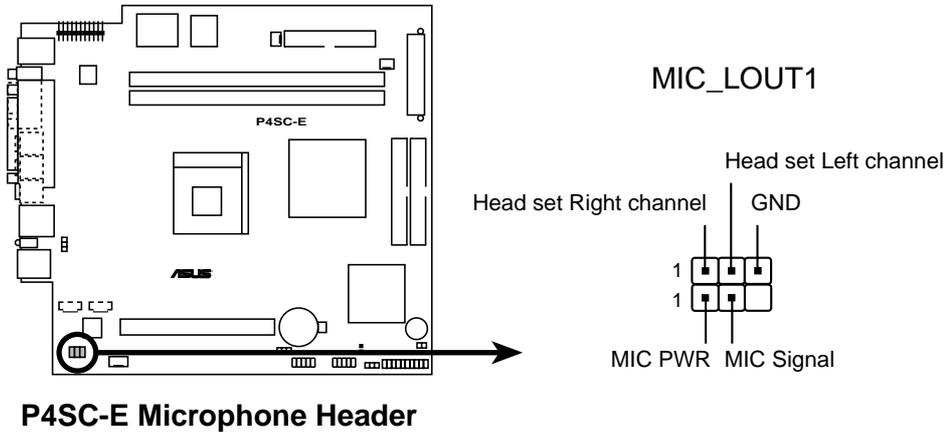

## 9. IO extension module connector (22-pin IOC\_MB)

This connector is for the CGAEX extension module.

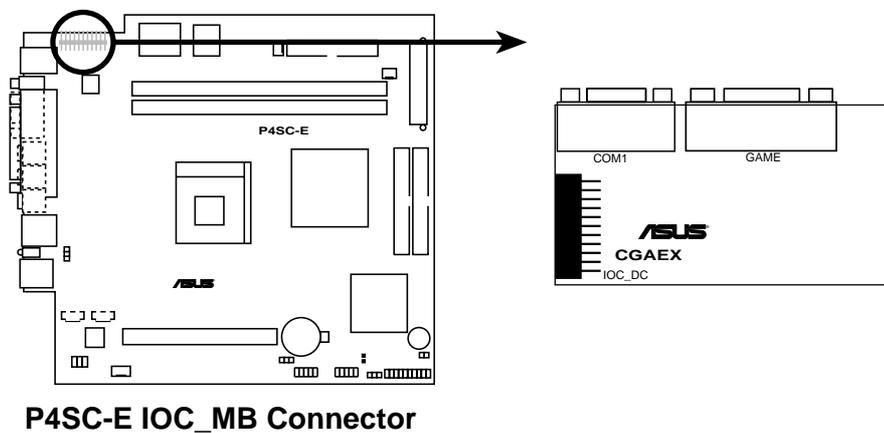

## 10. System panel connector (20-pin PANEL1)

This connector accommodates several system front panel functions.

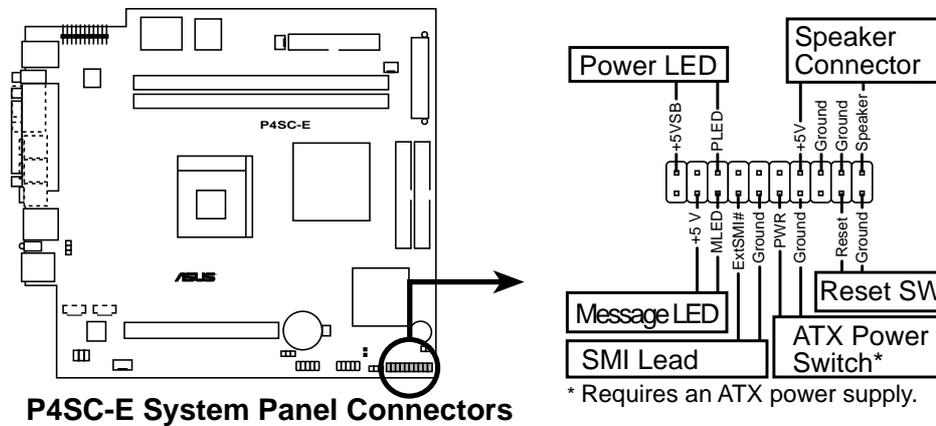

- **System Power LED Lead (3-1 pin PLED)**

This 3-1 pin connector connects to the system power LED. The LED lights up when you turn on the system power, and blinks when the system is in sleep mode.

- **System Warning Speaker Lead (4-pin SPEAKER)**

This 4-pin connector connects to the case-mounted speaker and allows you to hear system beeps and warnings.

- **System Message LED Lead (2-pin MLED)**

This 2-pin connector is for the system message LED that indicates receipt of messages from a fax/modem. The normal status for this LED is OFF, when there is no incoming data signal. The LED blinks when data is received. The system message LED feature requires an ACPI OS and driver support.

- **System Management Interrupt Lead (2-pin SMI)**

This 2-pin connector allows you to manually place the system into a suspend mode, or “green” mode, where system activity is instantly decreased to save power and to expand the life of certain system components. Attach the case-mounted suspend switch to this 2-pin connector.

- **ATX Power Switch / Soft-Off Switch Lead (2-pin PWR)**

This connector connects a switch that controls the system power. Pressing the power switch turns the system between ON and SLEEP, or ON and SOFT OFF, depending on the BIOS or OS settings. Pressing the power switch while in the ON mode for more than 4 seconds turns the system OFF.

- **Reset Switch Lead (2-pin RESET)**

This 2-pin connector connects to the case-mounted reset switch for rebooting the system without turning off the system power.

# Chapter 4

This chapter tells how to change system settings through the BIOS Setup menus. It includes detailed descriptions of the BIOS parameters.

# BIOS Information

# 4.1 Managing and updating the BIOS

## 4.1.1 Using the computer system for the first time

It is recommended that you save a copy of the original motherboard BIOS along with a Flash Memory Writer utility (AFLASH.EXE) to a bootable floppy disk in case you need to reinstall the BIOS later. AFLASH.EXE is a Flash Memory Writer utility that updates the BIOS by uploading a new BIOS file to the programmable flash ROM on the motherboard. This file works only in DOS mode. To determine the BIOS version of your motherboard, check the last four numbers of the code displayed on the upper left-hand corner of your screen during bootup. Larger numbers represent a newer BIOS file.

1. Type `FORMAT A:/S` at the DOS prompt to create a bootable system disk. DO NOT copy `AUTOEXEC.BAT` and `CONFIG.SYS` to the disk.
2. Type `COPY D:\AFLASH\AFLASH.EXE A:\` (assuming D is your CD-ROM drive) to copy `AFLASH.EXE` to the boot disk you created.

---

**NOTE**

AFLASH works only in DOS mode. It does not work in the DOS prompt within Windows, and does not work with certain memory drivers that may be loaded when you boot from the hard drive. It is recommended that you reboot using a floppy disk.

---

3. Reboot the computer from the floppy disk.

---

**NOTE**

BIOS setup must specify "Floppy" as the first item in the boot sequence.

---

- In DOS mode, type A:\AFLASH <Enter> to run AFLASH.

```
ASUS ACPI BIOS
FLASH MEMORY WRITER V2.0
Copyright (C) 1994-2001 ASUSTeK COMPUTER INC.

Flash Memory: Winbond W29C020 or SST 29EE020 or Intel B29020B

Current BIOS Version: ASUS XXX-XX ACPI BIOS Revision 100X
BIOS Model          : XXX-XX
BIOS Built Date     : 12/25/01

Choose one of the following:

1. Save Current BIOS To File
2. Update BIOS including Boot Block and ESCD

Enter choice: [1]

Press ESC To Exit
```

---

### IMPORTANT

If the word “unknown” appears after Flash Memory:, the memory chip is either not programmable or is not supported by the ACPI BIOS and therefore, cannot be programmed by the Flash Memory Writer utility.

---

- Select 1. Save Current BIOS to File from the Main menu and press <Enter>. The Save Current BIOS To File screen appears.

```
Save Current BIOS To File

Flash Memory: Winbond W29C020 or SST 29EE020 or Intel B29020B

Current BIOS Version: ASUS XXX-XX ACPI BIOS Revision 100X
BIOS Model          : XXX-XX
BIOS Built Date     : 12/25/01

Please Enter File Name to Save: XXX-XX.XXX

BIOS Saved Successfully

Press ESC To Continue
```

- Type a filename and the path, for example, A:\XXX-XX.XXX, then press <Enter>.

## 4.1.2 Updating BIOS procedures

### CAUTION!

Update the BIOS only if you have problems with the motherboard and you are sure that the new BIOS revision will solve your problems. Careless updating may result to more problems with the motherboard!

1. Download an updated ASUS BIOS file from the Internet (WWW or FTP) (see ASUS CONTACT INFORMATION on page x for details) and save to the boot floppy disk you created earlier.
  2. Boot from the floppy disk.
  3. At the "A:\\" prompt, type AFLASH and then press <Enter>.
  4. At the Main Menu, type 2 then press <Enter>. The Update BIOS Including Boot Block and ESCD screen appears.
  5. Type the filename of your new BIOS and the path, for example, A:\XXX-XX.XXX, then press <Enter>.
- To cancel this operation, press <Enter>.

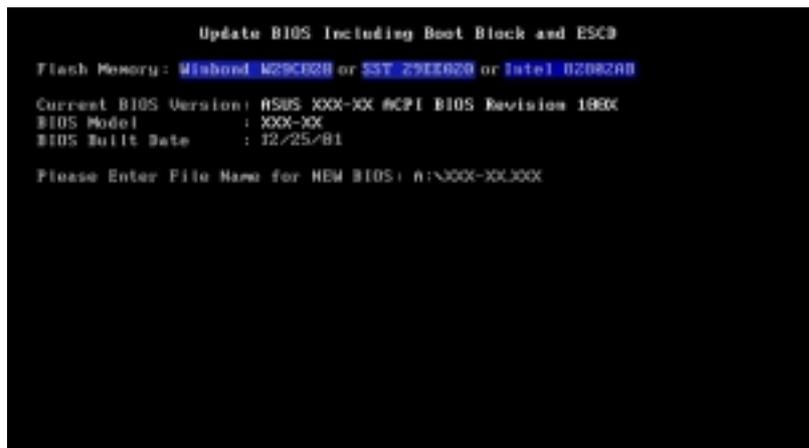

6. When prompted to confirm the BIOS update, press Y to start the update.

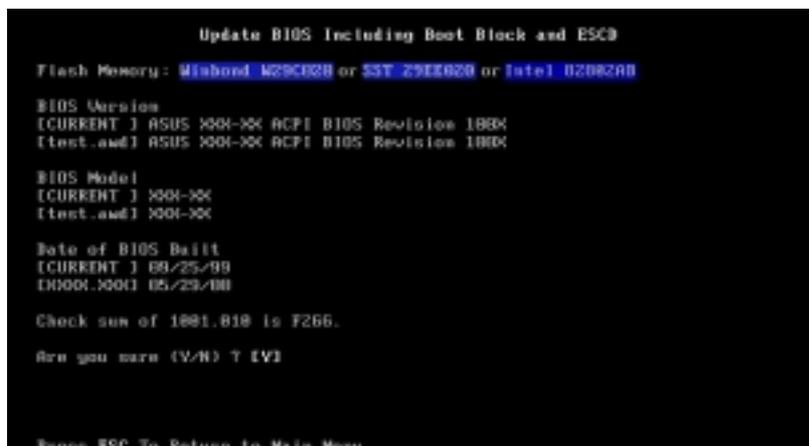



7. The utility starts to program the new BIOS information into the Flash ROM. The boot block is updated automatically only when necessary. This minimizes the possibility of boot problems in case of update failures. When the programming is done, the message “*Flashed Successfully*” appears.

```
Update BIOS Including Boot Block and ESCD
Flash Memory: Winbond W29C02B or SST 29EE02B or Intel B2082AB

BIOS Version
(CURRENT) ASUS XXX-XX ACPI BIOS Revision 18XX
(Inst. and) ASUS XXX-XX ACPI BIOS Revision 18XX

BIOS Model
(CURRENT) XXX-XX
(Inst. and) XXX-XX

Date of BIOS Built
(CURRENT) 12/25/01
(D0001,0001) 05/23/00

Check sum of 1881.818 is F266.

Are you sure (Y/N) ? Y
Block Erasing -- Done
Programming -- 3FFFF
Flashed Successfully

Press ESC To Continue
```

8. Follow the onscreen instructions to continue.

```
ASUS ACPI BIOS
FLASH MEMORY WRITER V2.0
Copyright (C) 1994-2001 ASUSTeK COMPUTER INC.

Flash Memory: Winbond W29C02B or SST 29EE02B or Intel B2082AB

Current BIOS Version: ASUS XXX-XX ACPI BIOS Revision 18XX
BIOS Model : XXX-XX
BIOS Built Date : 12/25/01

Choose one of the followings:
1. Save Current BIOS To File
2. Update BIOS Including Boot Block and ESCD

Enter choice: [1]

You have flashed the EPROM. It is recommended that you turn off
the power, enter SETUP and Load Setup Defaults to have CMOS
updated with new BIOS when exits.

Press ESC To Exit
```

---

### WARNING!

If you encounter problems while updating the new BIOS, DO NOT turn off the system because this may cause boot problems. Just repeat the process, and if the problem persists, load the original BIOS file you saved to the boot disk. If the Flash Memory Writer utility is not able to successfully update a complete BIOS file, the system may not boot. If this happens, call the ASUS service center for support.

---

## 4.2 BIOS Setup program

This motherboard supports a programmable EEPROM that you can update using the provided utility described in section “4.1 Managing and updating your BIOS.”

Use the BIOS Setup program when you are installing a motherboard, reconfiguring your system, or prompted to “Run Setup”. This section explains how to configure your system using this utility.

Even if you are not prompted to use the Setup program, you may want to change the configuration of your computer in the future. For example, you may want to enable the security password feature or make changes to the power management settings. This requires you to reconfigure your system using the BIOS Setup program so that the computer can recognize these changes and record them in the CMOS RAM of the EEPROM.

The EEPROM on the motherboard stores the Setup utility. When you start up the computer, the system provides you with the opportunity to run this program. Press <Delete> during the Power-On Self Test (POST) to enter the Setup utility, otherwise, POST continues with its test routines.

If you wish to enter Setup after POST, restart the system by pressing <Ctrl> + <Alt> + <Delete>, or by pressing the reset button on the system chassis. You can also restart by turning the system off and then back on. Do this last option only if the first two failed.

The Setup program is designed to make it as easy to use as possible. It is a menu-driven program, which means you can scroll through the various sub-menus and make your selections among the predetermined choices.

---

### NOTE

Because the BIOS software is constantly being updated, the following BIOS setup screens and descriptions are for reference purposes only, and may not exactly match what you see on your screen.

---

## 4.2.1 BIOS menu bar

The top of the screen has a menu bar with the following selections:

- MAIN** Use this menu to make changes to the basic system configuration.
- ADVANCED** Use this menu to enable and make changes to the advanced features.
- POWER** Use this menu to configure and enable Power Management features.
- BOOT** Use this menu to configure the default system device used to locate and load the Operating System.
- EXIT** Use this menu to exit the current menu or to exit the Setup program.

To access the menu bar items, press the right or left arrow key on the keyboard until the desired item is highlighted.

## 4.2.2 Legend bar

At the bottom of the Setup screen is a legend bar. The keys in the legend bar allow you to navigate through the various setup menus. The following table lists the keys found in the legend bar with their corresponding functions.

<b>Navigation Key(s)</b>	<b>Function Description</b>
<F1> or <Alt + H>	Displays the General Help screen from anywhere in the BIOS Setup
<Esc>	Jumps to the Exit menu or returns to the main menu from a sub-menu
Left or Right arrow	Selects the menu item to the left or right
Up or Down arrow	Moves the highlight up or down between fields
- (minus key)	Scrolls backward through the values for the highlighted field
+ (plus key) or spacebar	Scrolls forward through the values for the highlighted field
<Enter>	Brings up a selection menu for the highlighted field
<Home> or <PgUp>	Moves the cursor to the first field
<End> or <PgDn>	Moves the cursor to the last field
<F5>	Resets the current screen to its Setup Defaults
<F10>	Saves changes and exits Setup

## General help

In addition to the Item Specific Help window, the BIOS setup program also provides a General Help screen. You may launch this screen from any menu by simply pressing <F1> or the <Alt> + <H> combination. The General Help screen lists the legend keys and their corresponding functions.

## Saving changes and exiting the Setup program

See “4.7 Exit Menu” for detailed information on saving changes and exiting the setup program.

## Scroll bar

When a scroll bar appears to the right of a help window, it indicates that there is more information to be displayed that will not fit in the window. Use <PgUp> and <PgDn> or the up and down arrow keys to scroll through the entire help document. Press <Home> to display the first page, press <End> to go to the last page. To exit the help window, press <Enter> or <Esc>.

## Sub-menu

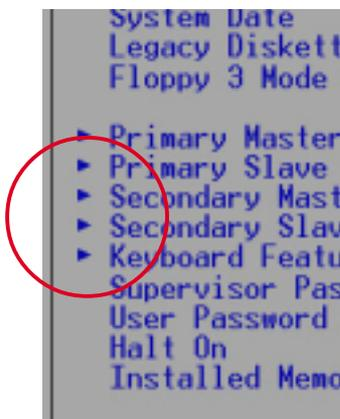

Note that a right pointer symbol (as shown on the left) appears to the left of certain fields. This pointer indicates that you can display a sub-menu from this field. A sub-menu contains additional options for a field parameter. To display a sub-menu, move the highlight to the field and press <Enter>. The sub-menu appears. Use the legend keys to enter values and move from field to field within a sub-menu as you would within a menu. Use the <Esc> key to return to the main menu.

Take some time to familiarize yourself with the legend keys and their corresponding functions. Practice navigating through the various menus and sub-menus. If you accidentally make unwanted changes to any of the fields, use the set default hot key <F5> to load the Setup default values. While moving around through the Setup program, note that explanations appear in the Item Specific Help window located to the right of each menu. This window displays the help text for the currently highlighted field.

## 4.3 Main Menu

When you enter the Setup program, the following screen appears.

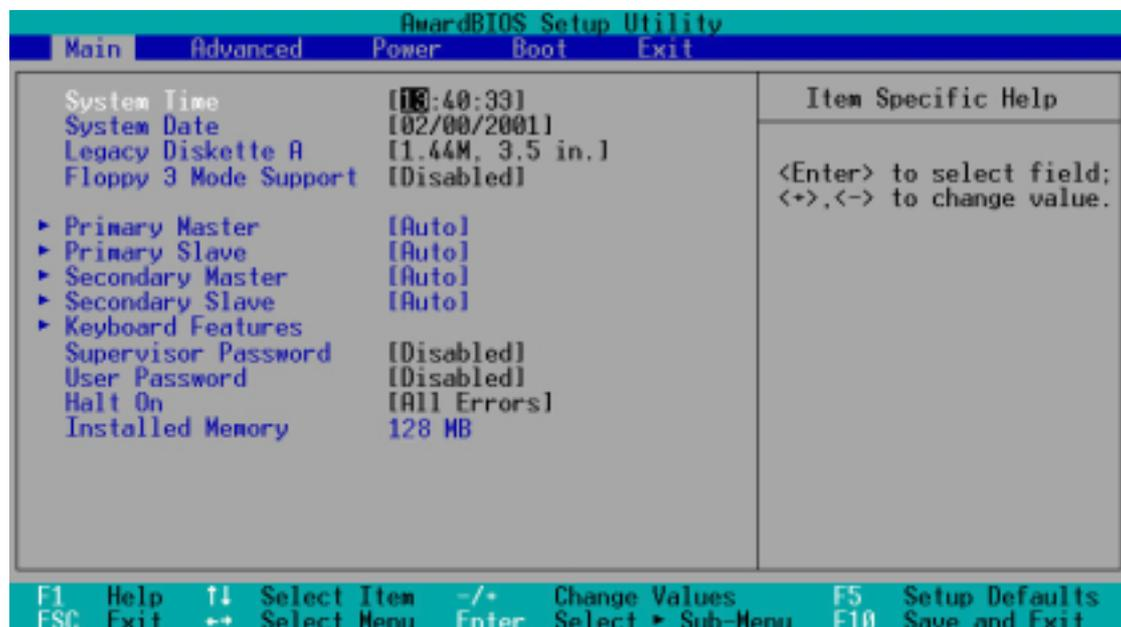

### System Time [XX:XX:XX]

Sets the system to the time that you specify (usually the current time). The format is hour, minute, second. Valid values for hour, minute and second are Hour: (00 to 23), Minute: (00 to 59), Second: (00 to 59). Use the <Tab> or <Shift> + <Tab> keys to move between the hour, minute, and second fields.

### System Date [XX/XX/XXXX]

Sets the system to the date that you specify (usually the current date). The format is month, day, year. Valid values for month, day, and year are Month: (1 to 12), Day: (1 to 31), Year: (up to 2084). Use the <Tab> or <Shift> + <Tab> keys to move between the month, day, and year fields.

### Legacy Diskette A [1.44M, 3.5 in.]

Sets the type of floppy drive installed. Configuration options: [None] [360K, 5.25 in.] [1.2M , 5.25 in.] [720K , 3.5 in.] [1.44M, 3.5 in.] [2.88M, 3.5 in.]

### Floppy 3 Mode Support [Disabled]

This is required to support older Japanese floppy drives. The Floppy 3 Mode feature allows reading and writing of 1.2MB (as opposed to 1.44MB) on a 3.5-inch diskette. Configuration options: [Disabled] [Enabled]

## **Supervisor Password [Disabled] / User Password [Disabled]**

These fields allow you to set passwords. To set a password, highlight the appropriate field and press <Enter>. Type in a password then press <Enter>. You can type up to eight alphanumeric characters. Symbols and other characters are ignored. To confirm the password, type the password again and press <Enter>. The password is now set to [Enabled]. This password allows full access to the BIOS Setup menus. To clear the password, highlight this field and press <Enter>. The same dialog box as above appears. Press <Enter>. The password is set to [Disabled].

### **A note about passwords**

The BIOS Setup program allows you to specify passwords in the Main menu. The passwords control access to the BIOS during system startup. Passwords are not case sensitive, meaning, passwords typed in either uppercase or lowercase letters are accepted. The BIOS Setup program allows you to specify two different passwords: a Supervisor password and a User password. If you did not set a Supervisor password, anyone can access the BIOS Setup program. If you did, the Supervisor password is required to enter the BIOS Setup program and to gain full access to the configuration fields.

### **Forgot the password?**

If you forget your password, you can clear it by erasing the CMOS Real Time Clock (RTC) RAM. The RAM data containing the password information is powered by the onboard button cell battery. See section "3.7 Jumpers" for information on how to erase the RTC RAM.

## **Halt On [All Errors]**

This field specifies the types of errors that will cause the system to halt. Configuration options: [All Errors] [No Error] [All but Keyboard] [All but Disk] [All but Disk/Keyboard]

## **Installed Memory [XXX MB]**

This field automatically displays the amount of conventional memory detected by the system during the boot process.

### 4.3.1 Primary and Secondary Master/Slave

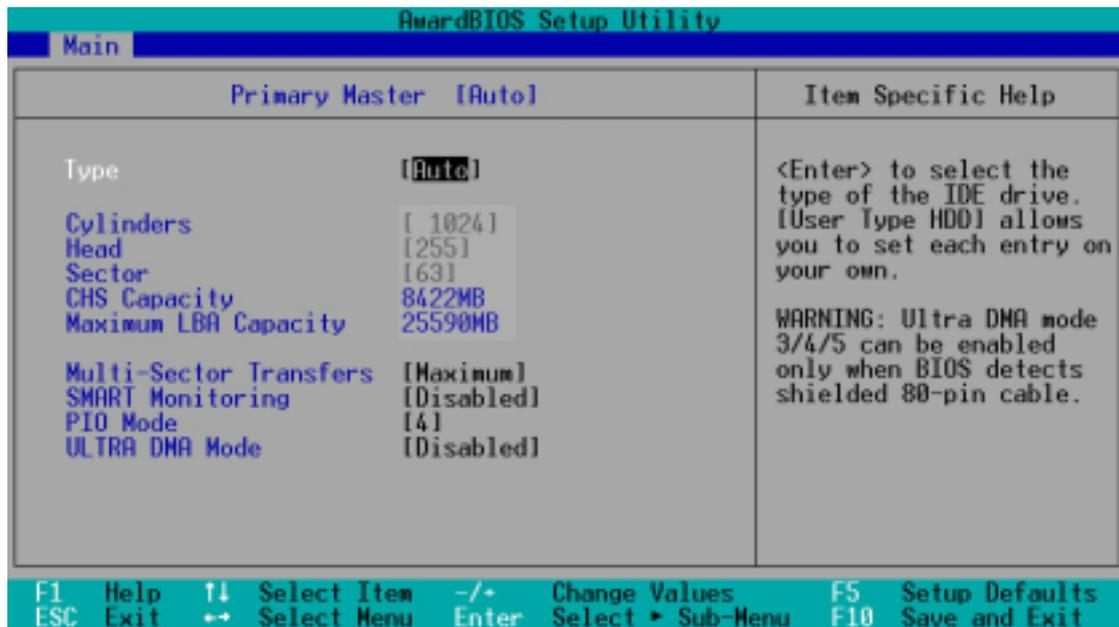

#### Type [Auto]

Select [Auto] to automatically detect an IDE hard disk drive. If automatic detection is successful, Setup automatically fills in the correct values for the remaining fields on this sub-menu. If automatic detection fails, this may be because the hard disk drive is too old or too new. If the hard disk was already formatted on an older system, Setup may detect incorrect parameters. In these cases, select [User Type HDD] to manually enter the IDE hard disk drive parameters. Refer to the next section for details.

---

#### CAUTION

Before attempting to configure a hard disk drive, make sure you have the correct configuration information supplied by the drive manufacturer. Incorrect settings may cause the system to fail to recognize the installed hard disk.

---

## [User Type HDD]

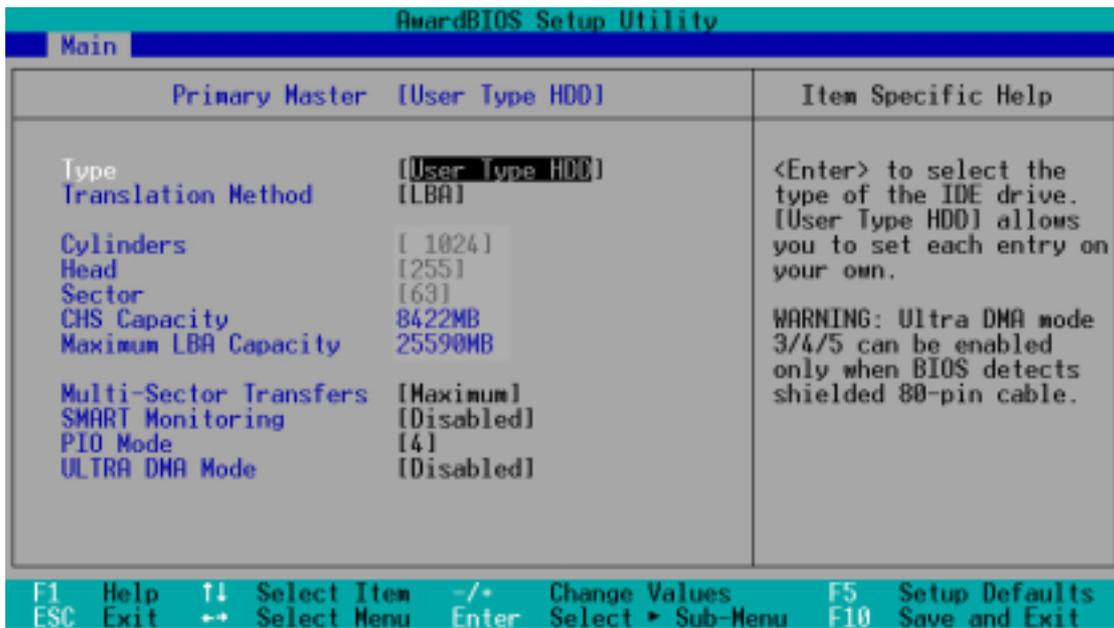

Manually enter the number of cylinders, heads and sectors per track for the drive. Refer to the drive documentation or on the drive label for this information.

### NOTE

After entering the IDE hard disk drive information into BIOS, use a disk utility, such as FDISK, to partition and format new IDE hard disk drives. This is necessary so that you can write or read data from the hard disk. Make sure to set the partition of the Primary IDE hard disk drives to active.

If no drive is installed or if you are removing a drive and not replacing it, select [None].

Other options for the Type field are:

**[CD-ROM]** - for IDE CD-ROM drives

**[LS-120]** - for LS-120 compatible floppy disk drives

**[ZIP]** - for ZIP-compatible disk drives

**[MO]** - for IDE magneto optical disk drives

**[Other ATAPI Device]** - for IDE devices not listed here

After making your selections on this sub-menu, press the <Esc> key to return to the Main menu. When the Main menu appears, the hard disk drive field displays the size for the hard disk drive that you configured.



## **Translation Method [LBA]**

Select the hard disk drive type in this field. When Logical Block Addressing (LBA) is enabled, the 28-bit addressing of the hard drive is used without regard for cylinders, heads, or sectors. Note that LBA Mode is necessary for drives with more than 504MB storage capacity. Configuration options: [LBA] [LARGE] [Normal] [Match Partition Table] [Manual]

## **Cylinders**

This field configures the number of cylinders. Refer to the drive documentation to determine the correct value. To make changes to this field, set the Type field to [User Type HDD] and the Translation Method field to [Manual].

## **Head**

This field configures the number of read/write heads. Refer to the drive documentation to determine the correct value. To make changes to this field, set the Type field to [User Type HDD] and the Translation Method field to [Manual].

## **Sector**

This field configures the number of sectors per track. Refer to the drive documentation to determine the correct value. To make changes to this field, set the Type field to [User Type HDD] and the Translation Method field to [Manual].

## **CHS Capacity**

This field shows the drive's maximum CHS capacity as calculated by the BIOS based on the drive information you entered.

## **Maximum LBA Capacity**

This field shows the drive's maximum LBA capacity as calculated by the BIOS based on the drive information you entered.

## **Multi-Sector Transfers [Maximum]**

This option automatically sets the number of sectors per block to the highest number that the drive supports. Note that when this field is automatically configured, the set value may not always be the fastest value for the drive. You may also manually configure this field. Refer to the documentation that came with the hard drive to determine the optimum value and set it manually. To make changes to this field, set the Type field to [User Type HDD]. Configuration options: [Disabled] [2 Sectors] [4 Sectors] [8 Sectors] [16 Sectors] [32 Sectors] [Maximum]

### **SMART Monitoring [Disabled]**

This field allows you to enable or disable the S.M.A.R.T. (Self-Monitoring, Analysis and Reporting Technology) system that utilizes internal hard disk drive monitoring technology. This parameter is normally disabled because the resources used in the SMART monitoring feature may decrease system performance. Configuration options: [Disabled] [Enabled]

### **PIO Mode [4]**

This option lets you set a PIO (Programmed Input/Output) mode for the IDE device. Modes 0 through 4 provide successive increase in performance. Configuration options: [0] [1] [2] [3] [4]

### **Ultra DMA Mode [Disabled]**

Ultra DMA capability allows improved transfer speeds and data integrity for compatible IDE devices. Set to [Disabled] to suppress Ultra DMA capability. To make changes to this field, set the Type field to [User Type HDD]. Configuration options: [0] [1] [2] [3] [4] [5] [Disabled]

## 4.3.2 Keyboard Features

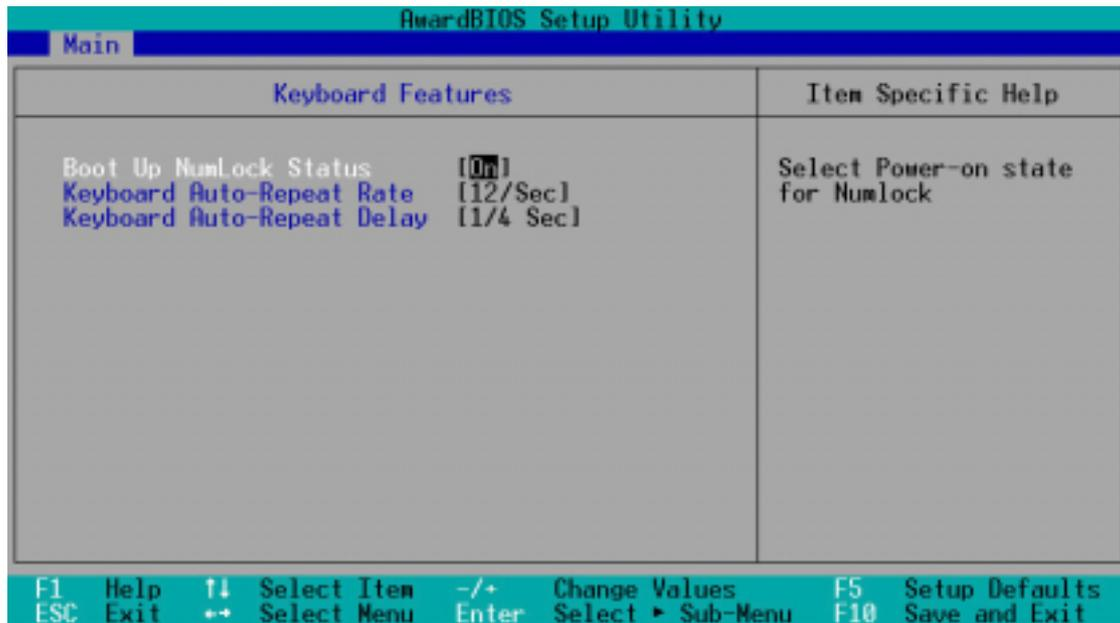

### Boot Up NumLock Status [On]

This field enables users to activate the Number Lock function upon system boot. Configuration options: [Off] [On]

### Keyboard Auto-Repeat Rate [12/Sec]

This controls the speed at which the system registers repeated keystrokes. Options range from 6 to 30 characters per second. Configuration options: [6/Sec] [8/Sec] [10/Sec] [12/Sec] [15/Sec] [20/Sec] [24/Sec] [30/Sec]

### Keyboard Auto-Repeat Delay [1/4 Sec]

This field sets the time interval for displaying the first and second characters. Configuration options: [1/4 Sec] [1/2 Sec] [3/4 Sec] [1 Sec]

## 4.4 Advanced Menu

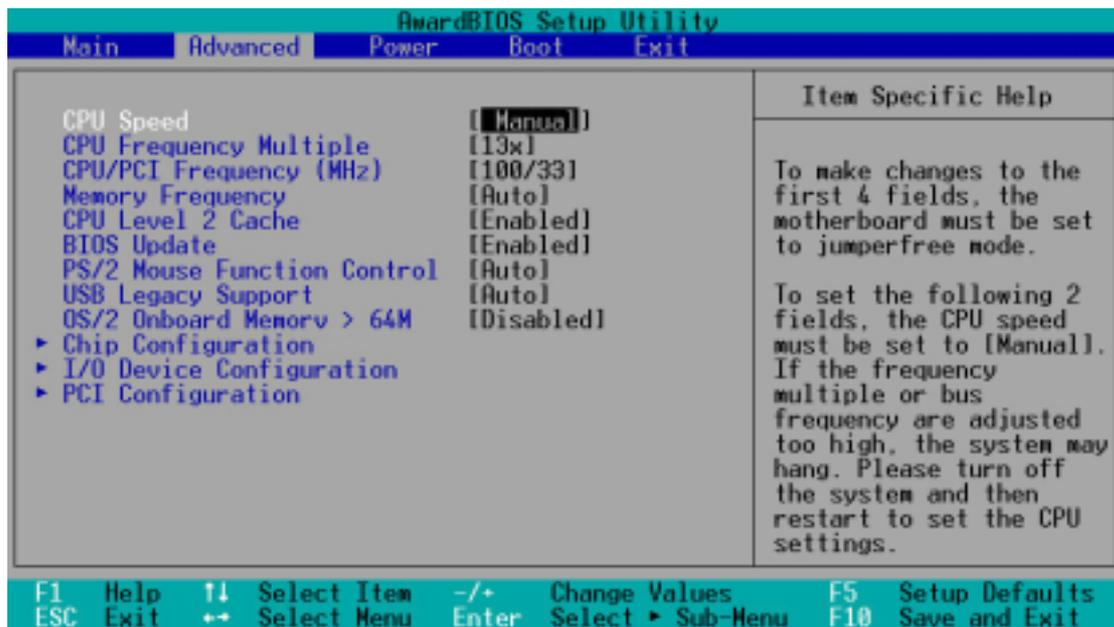

### CPU Speed [Manual]

This parameter allows you select the CPU internal frequency. You can select either one of the preset speeds, [2200 MHz] or [2933 MHz], or select [Manual] if you wish to adjust the setting of the next item, CPU Frequency Multiple. Configuration options: [Manual] [2200 MHz] [2933 MHz]

#### CAUTION

Be careful when setting the CPU internal frequency. Selecting a frequency higher than what the CPU manufacturer recommends may cause the system to hang or crash!

### CPU Frequency Multiple (when CPU Speed is set to [Manual])

This field is for unlocked processors only. If your processor frequency multiple is locked, you cannot access this field. This field sets the frequency multiple between the CPU's internal frequency (CPU speed) and external frequency.

### CPU/PCI Frequency (MHz)

This feature tells the clock generator what frequency to send to the system bus and PCI bus. The bus frequency (external frequency) multiplied by the bus multiple equals the CPU speed.

## **Memory Frequency [Auto]**

This field determines whether the memory clock frequency is set to be in synchronous or asynchronous mode with respect to the system frequency. The options that appear in the popup menu vary according to the CPU/PCI Frequency (MHz). Configuration options: [Auto] [1:1] [3:4] [3:5]

## **CPU Level 2 Cache [Enabled]**

These fields allow you to choose from the default of [Enabled] or choose [Disabled] to turn the CPU Level 2 built-in cache on or off. Configuration options: [Disabled] [Enabled]

## **BIOS Update [Enabled]**

This field functions as an update loader integrated into the BIOS to supply the processor with the required data. When set to [Enabled], the BIOS loads the update on all processors during system bootup. Configuration options: [Disabled] [Enabled]

## **PS/2 Mouse Function Control [Auto]**

The default setting [Auto] allows the system to detect a PS/2 mouse at startup. If a mouse is detected, the BIOS assigns IRQ12 to the PS/2 mouse. Otherwise, IRQ12 can be used for expansion cards. When you set this field to [Enabled], BIOS reserves IRQ12, whether or not a PS/2 mouse is detected at startup. Configuration options: [Enabled] [Auto]

## **USB Legacy Support [Auto]**

This motherboard supports Universal Serial Bus (USB) devices. The default of [Auto] allows the system to detect a USB device at startup. If detected, the USB controller legacy mode is enabled. If not detected, the USB controller legacy mode is disabled.

When you set this field to [Disabled], the USB controller legacy mode is disabled whether or not you are using a USB device. Configuration options: [Disabled] [Enabled] [Auto]

## **OS/2 Onboard Memory > 64M [Disabled]**

When using OS/2 operating systems with installed DRAM of greater than 64MB, you need to set this option to [Enabled]. Otherwise, leave to the default setting [Disabled]. Configuration options: [Disabled] [Enabled]

## 4.4.1 Chip Configuration

AwardBIOS Setup Utility		
Advanced		
Chip Configuration		Item Specific Help
SDRAM Configuration	[By SPD]	<Enter> to select SDRAM configuration. [By SPD] is recommended. [User Defined] allows you to set each configuration on your own.
SDRAM CAS Latency	[2T]	
SDRAM RAS to CAS Delay	[3T]	
SDRAM RAS Precharge Time	[3T]	
SDRAM RAS Active Time	[6T]	
SDRAM Command Lead-off Time	[Auto]	
Graphics Aperture Size	[64MB]	
AGP Capability	[4X Mode]	
AGP Fast Write Capability	[Disabled]	
Onboard VGA Shared Memory Size	[32M]	
Video Memory Cache Mode	[UC]	
Memory Hole At 15M-16M	[Disabled]	
PCI 2.1 Support	[Enabled]	
Onboard PCI IDE Enable	[Both]	
IDE Bus Master Support	[Enabled]	

F1 Help ↑↓ Select Item -/+ Change Values F5 Setup Defaults  
ESC Exit ↔ Select Menu Enter Select → Sub-Menu F10 Save and Exit

### SDRAM Configuration [By SPD]

This parameter allows you to set the optimal timings for items 2–5, depending on the memory modules that you are using. The default setting is [By SPD], which configures items 2–5 by reading the contents in the SPD (Serial Presence Detect) device. The EEPROM on the memory module stores critical information about the module, such as memory type, size, speed, voltage interface, and module banks.

Configuration options: [User Defined] [By SPD]

---

#### NOTE

The SDRAM parameters (items 2–5) become configurable only when you set the SDRAM Configuration to [User Defined].

---

### SDRAM CAS Latency [2T]

This item controls the latency between the SDRAM read command and the time the data actually becomes available.

### SDRAM RAS to CAS Delay [3T]

This item controls the latency between the SDRAM active command and the read/write command.

### SDRAM RAS Precharge Time [3T]

This item controls the idle clocks after issuing a precharge command to the SDRAM.

### **SDRAM Active Time [6T]**

This item controls the number of SDRAM clocks used for SDRAM parameters.

### **SDRAM Command Lead-off Time [Auto]**

This item allows you to select the SDRAM lead-off time. Configuration options: [Auto] [2T] [1T]

### **Graphics Aperture Size [64MB]**

This item allows you to select the size of mapped memory for AGP graphic data. Configuration options: [4MB] [8MB] [16MB] [32MB] [64MB] [128MB] [256MB]

### **AGP Capability [4X Mode]**

When set to [4X Mode], this item allows 1066MB/s video data transfers through the AGP 4X interface card. When set to [1X Mode], the AGP interface only provides a peak data throughput of 266MB/s even if you are using an AGP 4X card. Configuration options: [1X Mode] [4X Mode]

### **AGP Fast Write Capability [Disabled]**

This item allows you to enable or disable the AGP fast write feature. The AGP fast write is a data transfer protocol that combines PCI and AGP protocols to support continuous data transfer directly from the chipset to the AGP. Configuration options: [Disabled] [Enabled]

### **Onboard VGA Shared Memory Size [32M]**

This item allows you to set the memory space reserved for the VGA frame buffer (display memory) within the system main memory. If you have installed a 3D graphics device, select at least 16MB VGA shared memory size. Note that the more system memory you share with VGA, the less memory space is left for other system devices. Configuration options: [4M] [8M] [16M] [32M] [64M]

### **Video Memory Cache Mode [UC]**

USWC (uncacheable, speculative write combining) is a new cache technology for the video memory of the processor. It can greatly improve the display speed by caching the display data. You must set this to UC (uncacheable) if your display card does not support this feature, otherwise the system may not boot. Configuration options: [UC] [USWC]

### **Memory Hole At 15M-16M [Disabled]**

This field allows you to reserve an address space for ISA expansion cards. Setting the address space to a particular setting makes that memory space unavailable to other system components. Expansion cards can only access memory up to 16MB. Configuration options: [Disabled] [Enabled]

## PCI 2.1 Support [Enabled]

This field allows you to enable or disable the PCI 2.1 features. Keep the default setting [Enabled] if you installed PCI 2.1 compliant cards. Set to [Disabled] if you installed any card that is not PCI 2.1 compliant.

Configuration options: [Disabled] [Enabled]

## Onboard PCI IDE [Both]

This field allows you to enable either the primary IDE channel or secondary IDE channel, or both. You can also set both channels to [Disabled]. Configuration options: [Both] [Primary] [Secondary] [Disabled]

## IDE Bus Master Support [Enabled]

This field allows you to enable or disable the IDE bus master feature.

Configuration options: [Disabled] [Enabled]

## 4.4.2 I/O Device Configuration

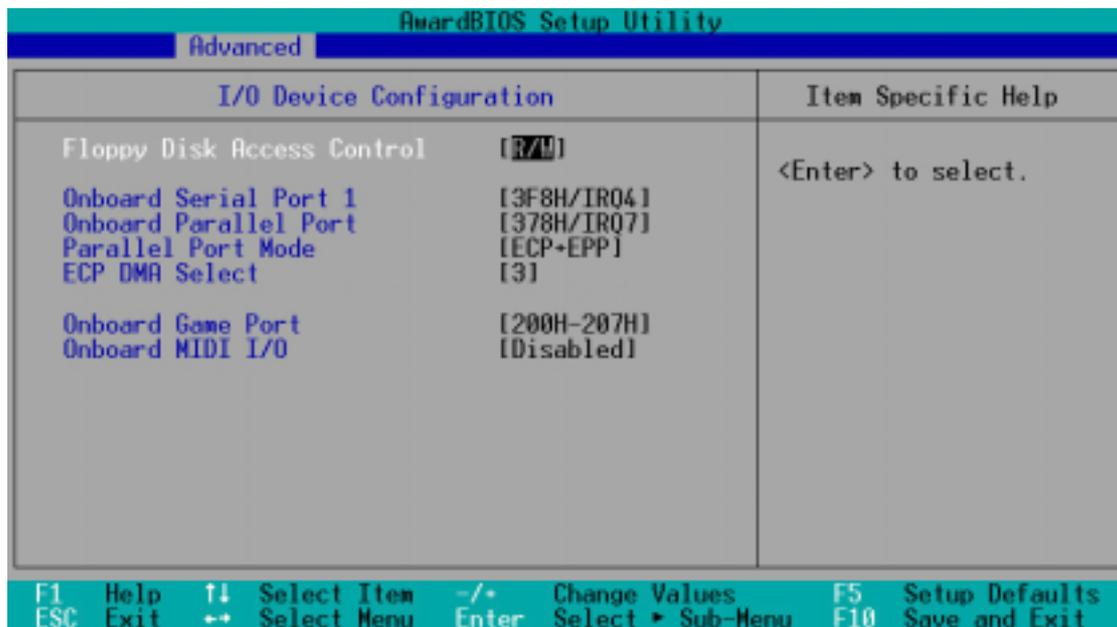



### **Floppy Disk Access Control [R/W]**

When set to [Read Only], this parameter protects files from being copied to floppy disks by allowing reads from, but not writes to, the floppy disk drive. The default setting [R/W] allows both reads and writes. Configuration options: [R/W] [Read Only]

### **Onboard Serial Port 1 [3F8H/IRQ4]**

This field allows you to set the I/O address and IRQ assignment for the onboard serial connector. Configuration options: [3F8H/IRQ4] [2F8H/IRQ3] [3E8H/IRQ4] [2E8H/IRQ10] [Disabled]

### **Onboard Parallel Port [378H/IRQ7]**

This field sets the address of the onboard parallel port connector. If you disable this field, the Parallel Port Mode and ECP DMA Select configurations are not available. Configuration options: [Disabled] [378H/IRQ7] [278H/IRQ5]

### **Parallel Port Mode [ECP+EPP]**

This field allows you to set the operation mode of the parallel port. [Normal] allows normal-speed operation but in one direction only; [EPP] allows bidirectional parallel port operation; [ECP] allows the parallel port to operate in bidirectional DMA mode; [ECP+EPP] allows normal speed operation in a two-way mode. Configuration options: [Normal] [EPP] [ECP] [ECP+EPP]

### **ECP DMA Select [3]**

This field allows you to configure the parallel port DMA channel for the selected ECP mode. This selection is available only if you select [ECP] or [ECP+EPP] in Parallel Port Mode above. Configuration options: [1] [3]

### **Onboard Game Port [200H-207H]**

This field allows you to set the I/O address for the onboard game port. Configuration options: [Disabled] [200H-207H] [208H-20FH]

### **Onboard MIDI I/O [Disabled]**

This field allows you to set the I/O address for the MIDI device. Configuration options: [Disabled] [330H-331H] [300H-301H]

### 4.4.3 PCI Configuration

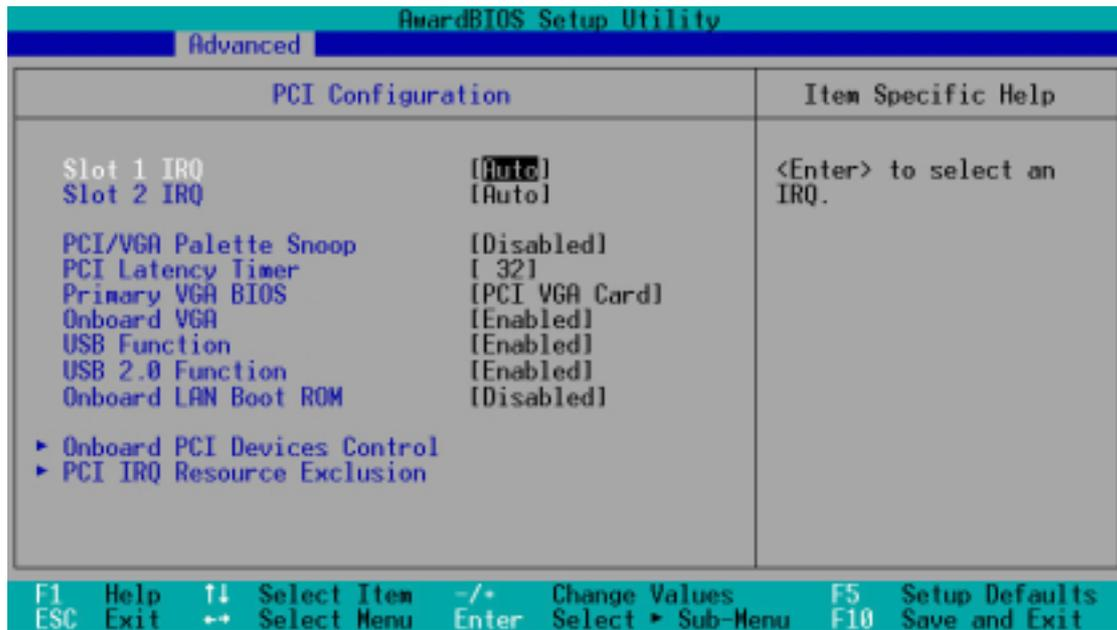

#### Slot 1, Slot 2 IRQ [Auto]

These fields automatically assign the IRQ for each PCI slot. The default setting for each field is [Auto], which utilizes auto-routing to determine IRQ assignments. Configuration options: [Auto] [NA] [3] [4] [5] [7] [9] [10] [11] [12] [14] [15]

#### PCI/VGA Palette Snoop [Disabled]

Some non-standard VGA cards, like graphics accelerators or MPEG video cards, may not show colors properly. Setting this field to [Enabled] corrects this problem. If you are using standard VGA cards, leave this field to the default setting [Disabled]. Configuration options: [Disabled] [Enabled]

#### PCI Latency Timer [32]

Leave this field to the default setting [32] for best performance and stability.

#### Primary VGA BIOS [PCI VGA Card]

This field allows you to select the primary graphics card. Configuration options: [PCI VGA Card] [AGP VGA Card] [Onboard VGA]

#### Onboard VGA [Enabled]

This field allows you to enable or disable the onboard VGA feature. Configuration options: [Disabled] [Enabled]

## USB Function [Enabled]

This motherboard supports Universal Serial Bus (USB) devices. Keep the default setting [Enabled] if you connect USB devices. Select [Disabled] if you do not wish to use the USB feature. Configuration options: [Disabled] [Enabled]

## USB 2.0 Function [Enabled]

This motherboard supports USB 2.0 specification. Keep the default setting [Enabled] if you connect USB 2.0 devices. Otherwise, select [Disabled]. Configuration options: [Disabled] [Enabled]

## Onboard LAN Boot ROM [Disabled]

This field allows you to enable or disable the option ROM on the onboard LAN chipset. Configuration options: [Disabled] [Enabled]

### 4.4.3.1 Onboard PCI Devices Control

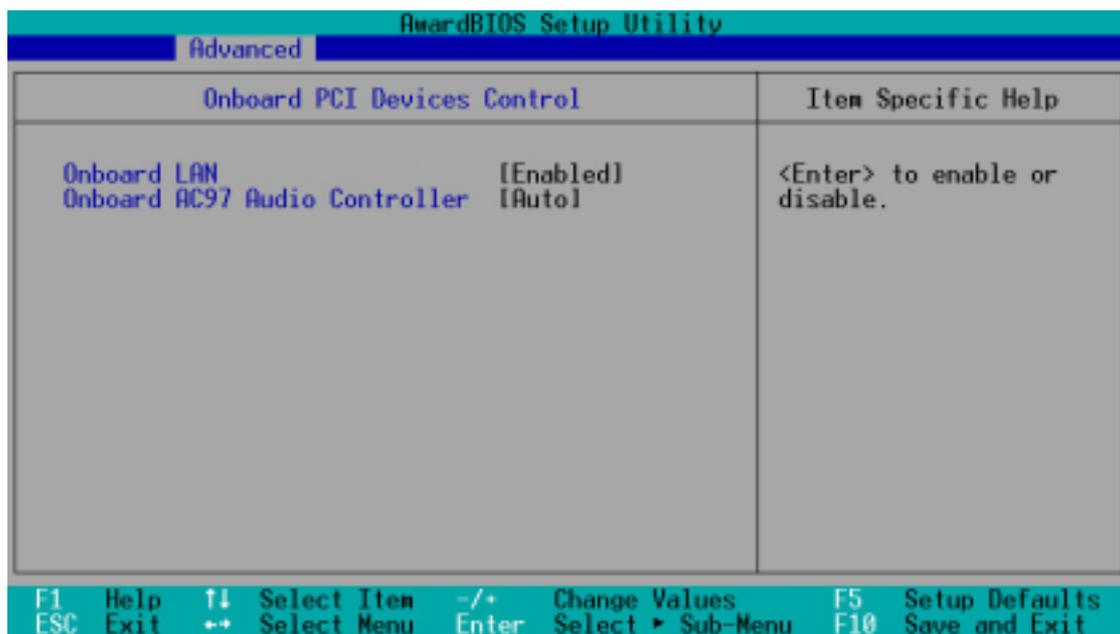

## Onboard LAN [Enabled]

This field allows you to enable or disable the onboard LAN controller. Keep the default enabled if you wish to use the onboard LAN feature. Set to [Disabled] if you installed a PCI LAN card. Configuration options: [Disabled] [Enabled]

## Onboard AC97 Audio Controller [Auto]

[Auto] allows the BIOS to detect whether you are using any modem/audio device. If a modem/audio device is detected, the onboard modem/audio controller is enabled; if no modem/audio device is detected, the controller is disabled. If there are conflicts with the onboard modem/audio controller, set the appropriate field to [Disabled]. Configuration options: [Disabled] [Auto]

### 4.4.3.2 PCI IRQ Resource Exclusion

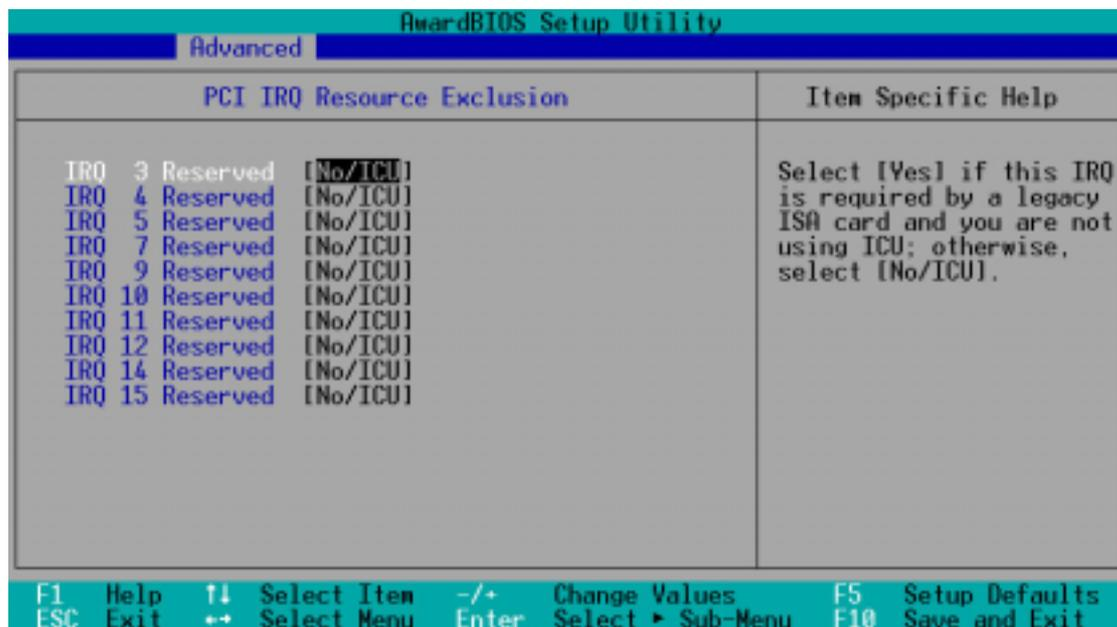

### IRQ XX Reserved [No/ICU]

These fields indicate whether or not the displayed IRQ for each field is being used by a legacy (non-PnP) ISA card. The setting [No/ICU] for an IRQ field indicates that you are using the ISA Configuration Utility (ICU), and that this particular IRQ is NOT required by a legacy ISA card. Set the IRQ field to [Yes] if you install a legacy ISA card that requires a unique IRQ and you are NOT using ICU. Configuration options: [No/ICU] [Yes]

## 4.5 Power Menu

The Power menu allows you to reduce power consumption. This feature turns off the video display and shuts down the hard disk after a period of inactivity.

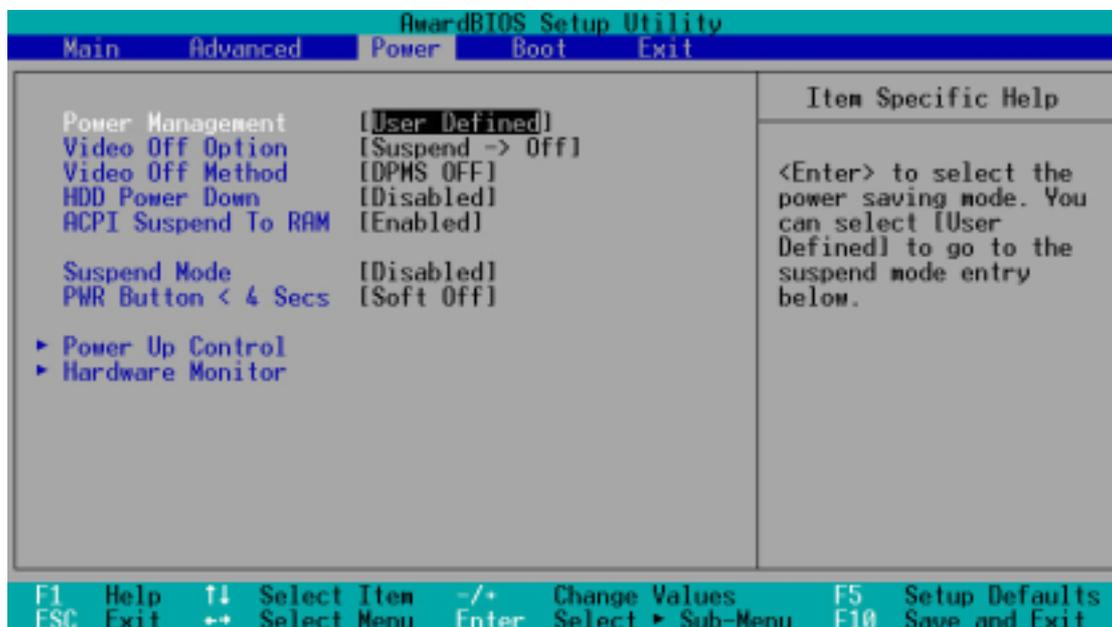

### Power Management [User Defined]

This field allows you to activate or deactivate the automatic power saving features. When set to [Disabled], the power management features do not function regardless of the other settings on this menu. The [User Defined] option allows you to set the period of inactivity before the system enters suspend mode. Refer to “Suspend Mode” later in this section.

When set to [Max Saving], system power is conserved to its greatest amount. This setting automatically puts the system into suspend mode after a brief period of system inactivity. [Min Saving] allows the least power saving as the system enters suspend mode only after a long period of inactivity. Configuration options: [User Defined] [Disabled] [Min Saving] [Max Saving]

---

#### IMPORTANT

You should install the Advanced Power Management (APM) utility to keep the system time updated even when the computer enters suspend mode. In Windows 3.x and Windows 95, you need to install Windows with the APM feature. In Windows 98 or later, APM is automatically installed as indicated by a battery and power cord icon labeled “Power Management” in the Control Panel. Select the item “Advanced” in the Power Management Properties dialog box.

---

## **Video Off Option [Suspend -> Off ]**

This field determines when to activate the video off feature for monitor power management. Configuration options: [Always On] [Suspend -> Off]

## **Video Off Method [DPMS OFF]**

This field defines the video off features. The Display Power Management System (DPMS) feature allows the BIOS to control the video display card if it supports the DPMS feature. [Blank Screen] only blanks the screen. Use this for monitors without power management or “green” features.

---

### **NOTE**

Even if installed, your screen saver does not display when you select [Blank Screen] for the above field.

---

[V/H SYNC+Blank] blanks the screen and turns off vertical and horizontal scanning. Configuration options: [Blank Screen] [V/H SYNC+Blank] [DPMS Standby] [DPMS Suspend] [DPMS OFF] [DPMS Reduce ON]

## **HDD Power Down [Disabled]**

Shuts down any IDE hard disk drives in the system after a period of inactivity as set in this user-configurable field. This feature does not affect SCSI hard drives. Configuration options: [Disabled] [1 Min] [2 Min] [3 Min]...[15 Min]

## **ACPI Suspend To RAM [Enabled]**

This field allows you to enable or disable the ACPI Suspend-to-RAM feature. To support this feature, the +5VSB of the power supply should have the capacity to provide more than 720mA current. Configuration options: [Disabled] [Enabled]

## **Suspend Mode [Disabled]**

Sets the time period before the system goes into suspend mode. Configuration options: [Disabled] [1~2 Min] [2~3 Min] [4~5 min] [8~9 Min] [20 Min] [30 Min]

## **PWR Button < 4 Secs [Soft Off]**

When set to [Soft off], the ATX switch can be used as a normal system power-off button when pressed for less than 4 seconds. [Suspend] allows the button to have a dual function where pressing less than 4 seconds puts the system in sleep mode. Regardless of the setting, holding the ATX switch for more than 4 seconds powers off the system. Configuration options: [Soft off] [Suspend]

## 4.5.1 Power Up Control

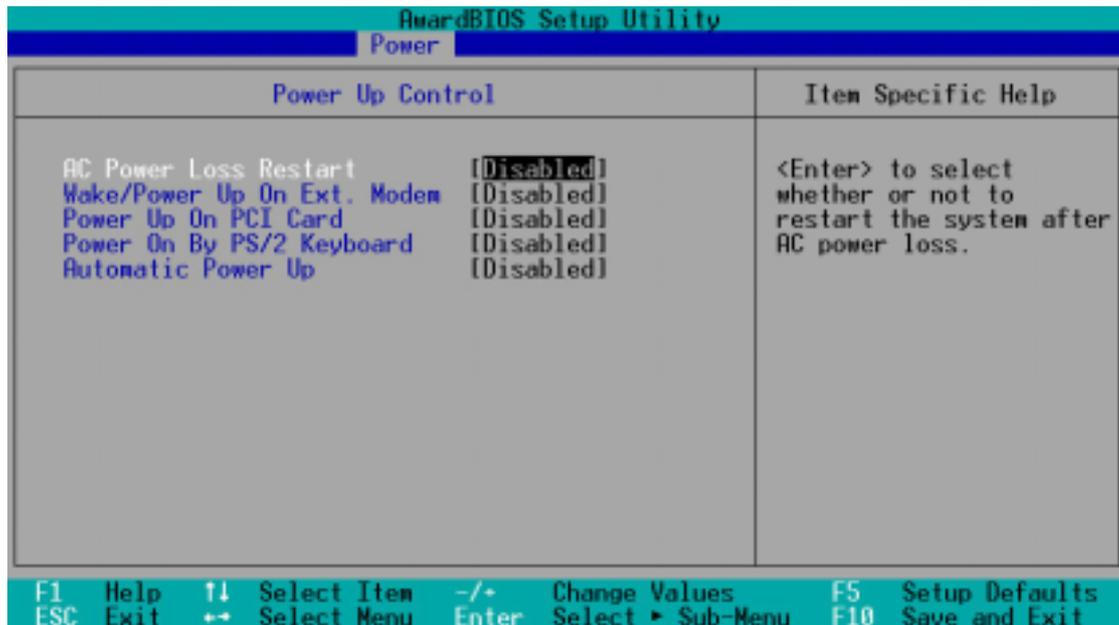

### AC PWR Loss Restart [Disabled]

This allows you to set whether or not to reboot the system after power interruptions. [Disabled] leaves your system off while [Enabled] reboots the system. [Previous State] sets the system back to the state it was before the power interruption. Configuration options: [Disabled] [Enabled] [Previous State]

### Wake/Power Up On Ext. Modem [Disabled]

This allows either settings of [Enabled] or [Disabled] for powering up the computer when the external modem receives a call while the computer is in Soft-off mode. Configuration options: [Disabled] [Enabled]

#### NOTE

The computer cannot receive or transmit data until the computer and applications are fully running. Thus, connection cannot be made on the first try. Turning an external modem off and then back on while the computer is off causes an initialization string that turns the system power on.

### Power Up On PCI Card [Disabled]

When set to [Enabled], this parameter allows you to turn on the system through a PCI modem. This feature requires an ATX power supply that provides at least 1A on the +5VSB lead. Configuration options: [Disabled] [Enabled]

## **Power On By PS/2 Keyboard [Space Bar]**

This parameter allows you to use specific keys on the keyboard to turn on the system. This feature requires an ATX power supply that provides at least 1A on the +5VSB lead. Configuration options: [Disabled] [Space Bar] [Ctrl-Esc] [Power Key]

## **Automatic Power Up [Disabled]**

This allows an unattended or automatic system power up. You may configure your system to power up at a certain time of the day by selecting [Everyday] or at a certain time and day by selecting [By Date]. Configuration options: [Disabled] [Everyday] [By Date]

---

### **NOTE**

The Automatic Power Up feature does not work if the system is powered down by an operating system, such Windows 98, that has Advanced Configuration and Power Interface (ACPI) support enabled. Refer to the Glossary for a description of ACPI specification.

---



## 4.5.2 Hardware Monitor

AwardBIOS Setup Utility		
Power		
Hardware Monitor	Item Specific Help	
CPU Q-Fan Function	[Enabled]	<Enter> to select.
CPU Temperature Threshold	[55°C]	
CPU Fan Lowest Level Voltage	[ 9V]	
PWR Q-Fan Function	[Enabled]	
PWR Temperature Threshold	[60°C]	
PWR Fan Lowest Level Voltage	[ 9V]	
Power Temperature	-1°C/30.5°F	
CPU Temperature	41°C/105.5°F	
CPU Fan Speed	4500RPM	
Chassis Fan Speed	5335RPM	
VCORE Voltage	1.50V	
+3.3V Voltage	3.47V	
+5V Voltage	4.91V	
+12V Voltage	12.09V	

F1 Help ↑ Select Item -/+ Change Values F5 Setup Defaults  
ESC Exit → Select Menu Enter Select ► Sub-Menu F10 Save and Exit

### CPU Q-Fan Function [Enabled]

This item allows you to enable or disable the ASUS Q-Fan feature that smartly adjusts the CPU fan speed for more efficient system operation. Configuration options: [Disabled] [Enabled]

### CPU Temperature Threshold [55°C]

This item allows you to set the highest temperature for the CPU so that when exceeded by the actual CPU temperature, Q-Fan supplies more power to the CPU fan. When the CPU temperature goes below the setting, Q-Fan automatically reverts to the normal power supplied to the fan. Configuration options: [50°C] [55°C] [60°C] [65°C] [70°C]

### CPU Fan Lowest Level Voltage [9V]

This item allows you to set the lowest voltage applied to the CPU fan. Configuration options: [6V] [6.5V] [7V] [7.5] [8V] [8.5] [9V]

### PWR Q-Fan Function [Enabled]

This item allows you to enable or disable the ASUS Q-Fan feature that smartly adjusts the power fan speed for more efficient system operation. Configuration options: [Disabled] [Enabled]

### **PWR Temperature Threshold [55°C]**

This item allows you to set the highest temperature for the power supply so that when exceeded by the actual power temperature, Q-Fan supplies more power to the power supply fan. When the CPU temperature goes below the setting, Q-Fan automatically reverts to the normal power supplied to the fan. Configuration options: [50°C] [55°C] [60°C] [65°C] [70°C]

### **PWR Fan Lowest Level Voltage [9V]**

This item allows you to set the lowest voltage applied to the CPU fan. Configuration options: [6V] [6.5V] [7V] [7.5] [8V] [8.5] [9V]

### **Power Temperature [xxx°C/xxx°F]**

#### **CPU Temperature [xxx°C/xxx°F]**

The onboard hardware monitor automatically detects and display the power supply and CPU temperatures in these fields.

#### **CPU Fan Speed [xxxxRPM]**

#### **Chassis Fan Speed [xxxxRPM]**

The onboard hardware monitor automatically detects the CPU and chassis fan speeds in rotations per minute (RPM).

### **VCORE Voltage, +3.3V Voltage, +5V Voltage, +12V Voltage**

The onboard hardware monitor automatically detects the voltage output through the onboard voltage regulators.

---

#### **NOTE**

If any of the monitored items is out of range, the following error message appears: "Hardware Monitor found an error. Enter Power setup menu for details". You will then be prompted to "Press F1 to continue or DEL to enter SETUP".

---

## 4.6 Boot Menu

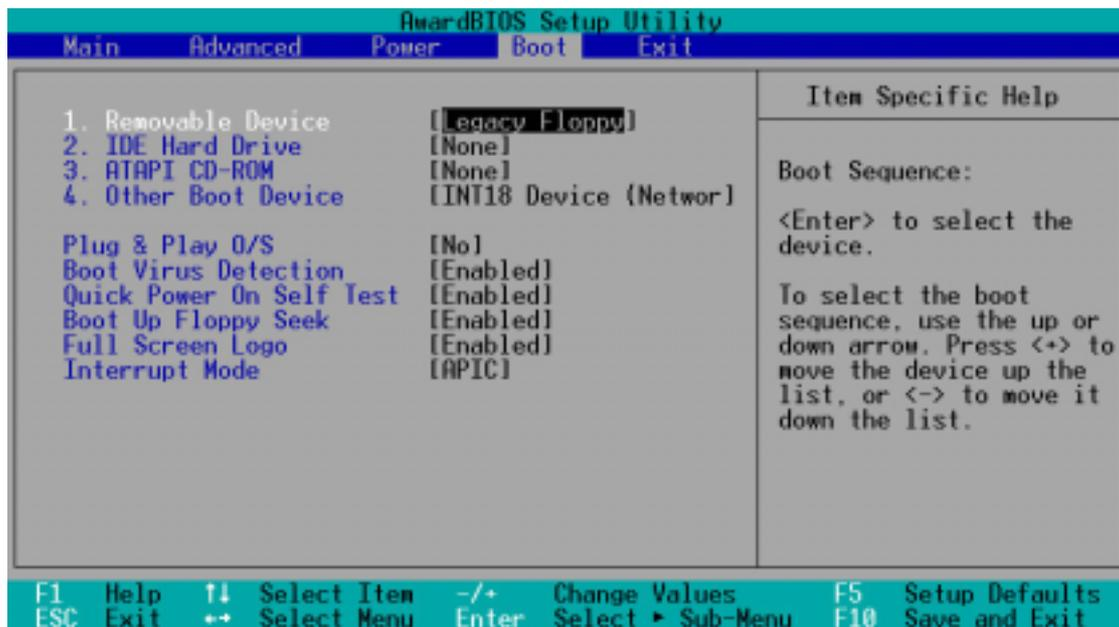

### Boot Sequence

The Boot menu allows you to select among the four possible types of boot devices listed using the up and down arrow keys. By using the <+> or <Space> key, you can promote devices and by using the <-> key, you can demote devices. Promotion or demotion of devices alters the priority which the system uses to search for a boot device on system power up. Configuration fields include Removable Devices, IDE Hard Drive, ATAPI CD-ROM, and Other Boot Device.

### Removable Device [Legacy Floppy]

Configuration options: [Disabled] [Legacy Floppy] [LS-120] [ZIP] [ATAPI MO]

### IDE Hard Drive

This field allows you to select which IDE hard disk drive to use in the boot sequence. Pressing [Enter] will show the product IDs of all connected IDE hard disk drives.

### ATAPI CD-ROM

This field allows you to select which ATAPI CD-ROM drive to use in the boot sequence. Pressing [Enter] will show the product IDs of all your connected ATAPI CD-ROM drives.

### Other Boot Device Select [INT18 Device (Network)]

Configuration options: [Disabled] [SCSI Boot Device] [INT18 Device (Network)]

### **Plug & Play O/S [No]**

This field allows you to use a Plug-and-Play (PnP) operating system to configure the PCI bus slots instead of using the BIOS. When [Yes] is selected, interrupts may be reassigned by the OS. If you installed a non-PnP OS or if you want to prevent reassigning of interrupt settings, keep the default setting [No]. Configuration options: [No] [Yes]

### **Boot Virus Detection [Enabled]**

This field allows you to set boot virus detection, ensuring a virus-free boot sector. The system halts and displays a warning message when it detects a virus. If this occurs, you can either allow the operation to continue or use a virus-free bootable floppy disk to restart and investigate your system. Configuration options: [Disabled] [Enabled]

### **Quick Power On Self Test [Enabled]**

This field speeds up the Power-On-Self Test (POST) routine by skipping retesting a second, third, and fourth time. Configuration options: [Disabled] [Enabled]

### **Boot Up Floppy Seek [Enabled]**

When enabled, the BIOS will seek the floppy disk drive to determine whether the drive has 40 or 80 tracks. Configuration options: [Disabled] [Enabled]

### **Full Screen Logo [Enabled]**

This allows you to enable or disable the full screen logo display feature. Configuration options: [Disabled] [Enabled]

### **Interrupt Mode [APIC]**

The Advanced Programmable Interrupt Controller (APIC) setting allows you to distribute interrupt routings other than the 16 IRQs. The Programmable Interrupt Controller (PIC) setting allows you to use the 16 IRQs only. Configuration options: [PIC] [APIC]

## 4.7 Exit Menu

When you have made all of your selections from the various menus in the Setup program, save your changes and exit Setup. Select Exit from the menu bar to display the following menu.

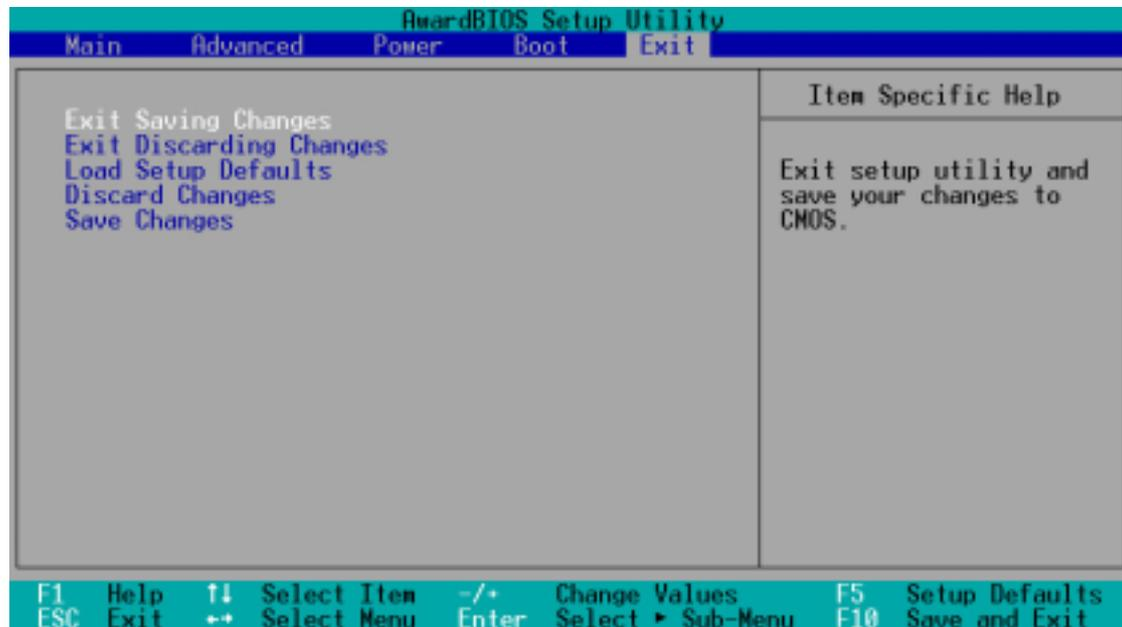

### NOTE

Pressing <Esc> does not immediately exit this menu. Select one of the options from this menu or <F10> from the legend bar to exit.

### Exit Saving Changes

Once you are finished making your selections, choose this option from the Exit menu to ensure the values you selected are saved to the CMOS RAM. The CMOS RAM is sustained by an onboard backup battery and stays on even when the PC is turned off. When you select this option, a confirmation window appears. Select [Yes] to save changes and exit.

### NOTE

If you attempt to exit the Setup program without saving your changes, the program prompts you with a message asking if you want to save your changes before exiting. Pressing <Enter> saves the changes while exiting.

### Exit Discarding Changes

Select this option only if you do not want to save the changes that you made to the Setup program. If you made changes to fields other than system date, system time, and password, the BIOS asks for a confirmation before exiting.

## **Load Setup Defaults**

This option allows you to load the default values for each of the parameters on the Setup menus. When you select this option or if you press <F5>, a confirmation window appears. Select [Yes] to load default values. Select Exit Saving Changes or make other changes before saving the values to the non-volatile RAM.

## **Discard Changes**

This option allows you to discard the selections you made and restore the previously saved values. After selecting this option, a confirmation appears. Select [Yes] to discard any changes and load the previously saved values.

## **Save Changes**

This option saves your selections without exiting the Setup program. You can then return to other menus and make further changes. After you select this option, a confirmation window appears. Select [Yes] to save any changes to the non-volatile RAM.

# Chapter 5

This chapter helps you power up your system and install drivers and utilities that came with the support CD.

# Starting up

## 5.1 Install an operating system

The P4SC-E motherboard supports Windows 98/ME/NT/2000/XP and OS/2 operating systems (OS). Always install the latest OS version and corresponding updates so you can maximize the features of your hardware.

---

### NOTE

Because motherboard settings and hardware options vary, use the setup procedures presented in this chapter for general reference only. Refer to your OS documentation for more information.

---

## 5.2 Support CD information

The support CD that came with the motherboard contains useful software and several utility drivers that enhance the motherboard features.

---

### NOTE

The contents of the support CD are subject to change at any time without notice. Visit the ASUS website for updates.

---

### 5.2.1 Running the support CD

To begin using the support CD, simply insert the CD into your CD-ROM drive. If Autorun is enabled in your computer, the software and drivers menu automatically appears on your screen.

If the installation menu did not appear automatically, locate and double-click on the file ASSETUP.EXE from the BIN folder in the support CD to display the menu.



## 5.2.2 Installation menus

The support CD menu is composed of two screens. Click on the **Right Arrow** on the lower right corner of the first screen to display the second menu screen. To return to the first menu screen, click on the **Left Arrow** on the lower right corner of the second screen.

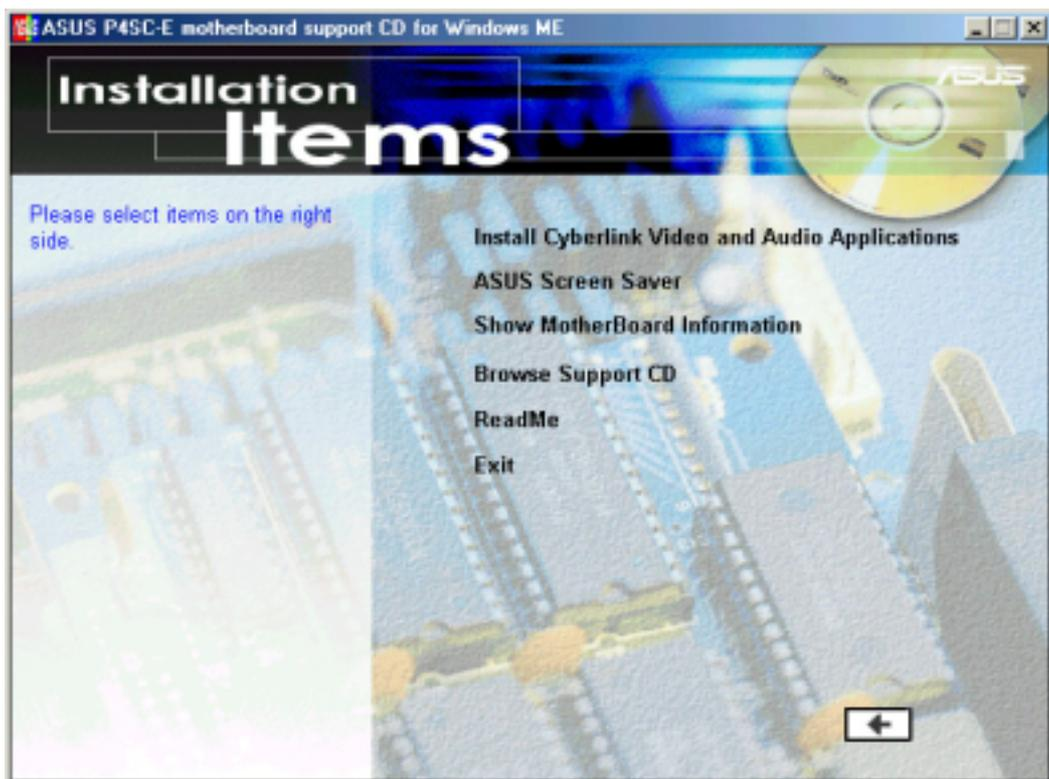
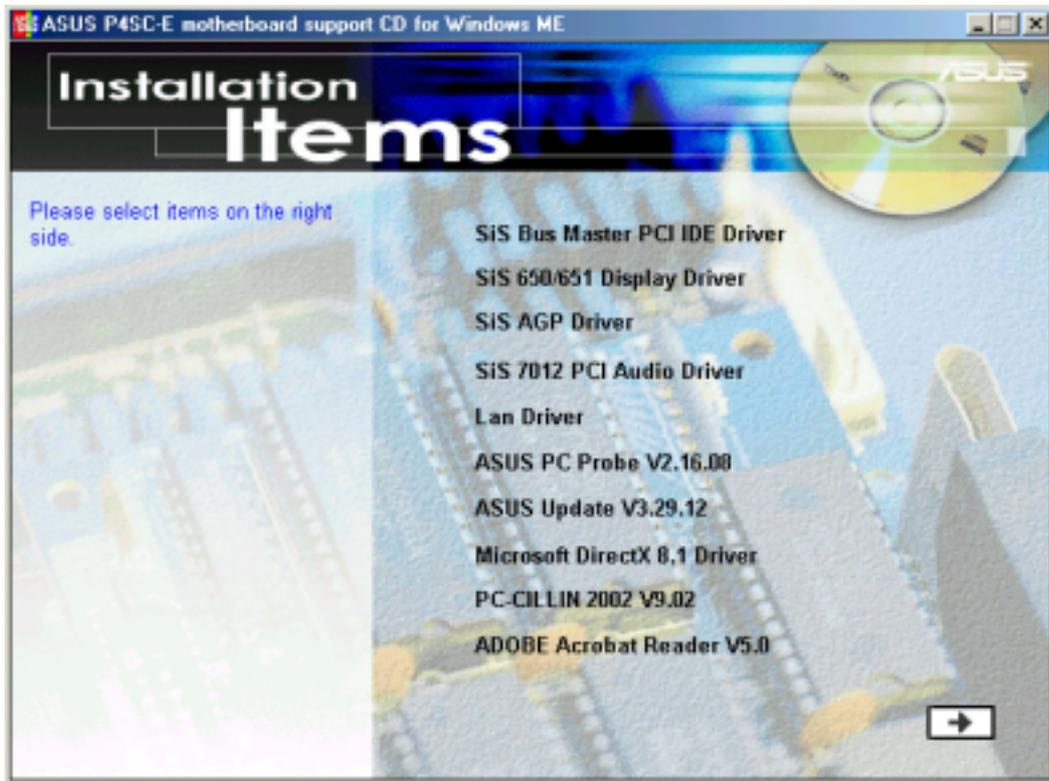

### **5.2.3 Software and drivers description**

The menu lists the drivers and applications that are available for this motherboard. Simply click on a specific item then follow the installation wizard to install it.

#### **SiS 650/651 Display Driver**

Click this item to load the installation wizard and install the SiS 650/651 display driver.

#### **SiS AGP Driver**

Click this item to load the installation wizard and install the SiS AGP driver V1.09.

#### **SiS 7012 PCI Audio Driver**

This item installs the SiS 7012 PCI audio driver V1.05.

#### **LAN Driver**

This item installs the SiS PCI LAN driver V1.14.

#### **ASUS PC Probe V2.16.08**

This smart utility monitors the fan speed, CPU temperature, and system voltages, and alerts you on any detected problems. This utility helps you keep your computer at a healthy operating condition.

#### **ASUS Update V3.29.12**

This item installs the ASUS Update. This program allows you to download the latest version of the BIOS from the ASUS website.

#### **Microsoft Direct X 8.1 Driver**

This item installs the Microsoft V8.1 driver.

#### **PC-cillin 2002 V9.02**

This item installs the PC-cillin 2002 V9.02 anti-virus software. View the PC-cillin online help for detailed information.

---

The above PC-cillin version supports Windows XP operating system and maintains backward compatibility with Windows 95.

---

## **ADOBE Acrobat Reader V5.0**

This item installs the Adobe Acrobat Reader V5.0. The Acrobat Reader software is for viewing files saved in Portable Document Format (PDF).

## **Install Cyberlink Video and Audio Applications**

This item installs the Cyberlink PowerPlayer SE 5.0 and Cyberlink VideoLive Mail 4.0.

## **ASUS Screen Saver**

This item installs the ASUS screen saver.

## **Show Motherboard Information**

Click this item to display the general specifications for the P4SC-E motherboard.

## **Browse Support CD**

Click this item to display the ASUS Terminator series support CD contents.

## **Readme**

This item displays the contents of the support CD and a brief description of each in text format.

## **Exit**

Click this item to exit the support CD.

## 5.3 Software information

Most of the applications in the support CD have wizards that will conveniently guide you through the installation. View the online help or readme file that came with the software for more information.

### 5.3.1 ASUS Update

The ASUS Update is a utility that allows you to update the motherboard BIOS and drivers. This utility requires an Internet connection either through a network or an Internet Service Provider (ISP).

Follow these steps to use the ASUS Update.

1. Launch the utility from your Windows Start menu:  
**Programs/AsusUpdate Vx.xx.xx/  
AsusUpdate**

The ASUS Update initial screen appears.

2. Select your desired update method, then click Next.
3. If you selected updating/downloading from the Internet, select the ASUS FTP site nearest you to avoid network traffic, or choose Auto Select. Click Next.

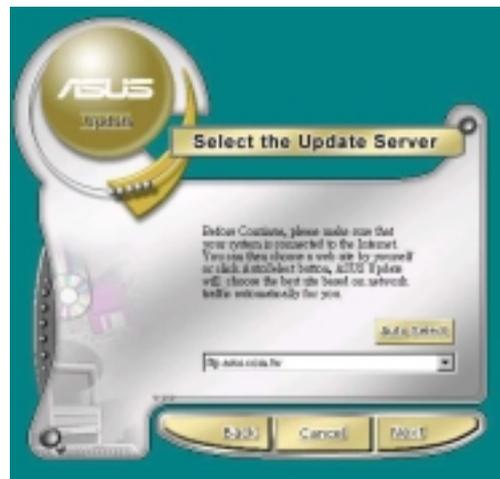
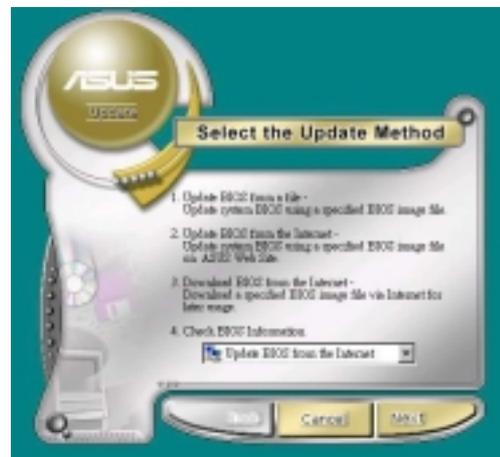

4. From the FTP site, select the BIOS version that you wish to download. Click Next.
5. Follow the instructions on the succeeding screens to complete the update process.



If you selected the option to update the BIOS from a file, a window pops up prompting you to locate the file. Select the file, click Save, then follow the screen instructions to complete the update process.

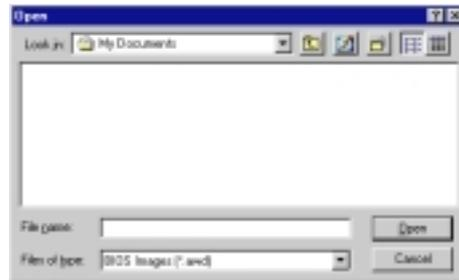

### 5.3.2 ASUS PC Probe

ASUS PC Probe is a convenient utility to continuously monitor your computer system's vital components, such as fan rotations, voltages, and temperatures. It also has a utility that lets you review useful information about your computer, such as hard disk space, memory usage, and CPU type, CPU speed, and internal/external frequencies through the DMI Explorer.

#### Starting ASUS PC Probe

When ASUS PC Probe starts, a splash screen appears allowing you to select whether to show the screen again when you open PC Probe or not. To bypass this startup screen, clear the **Show up in next execution** check box.

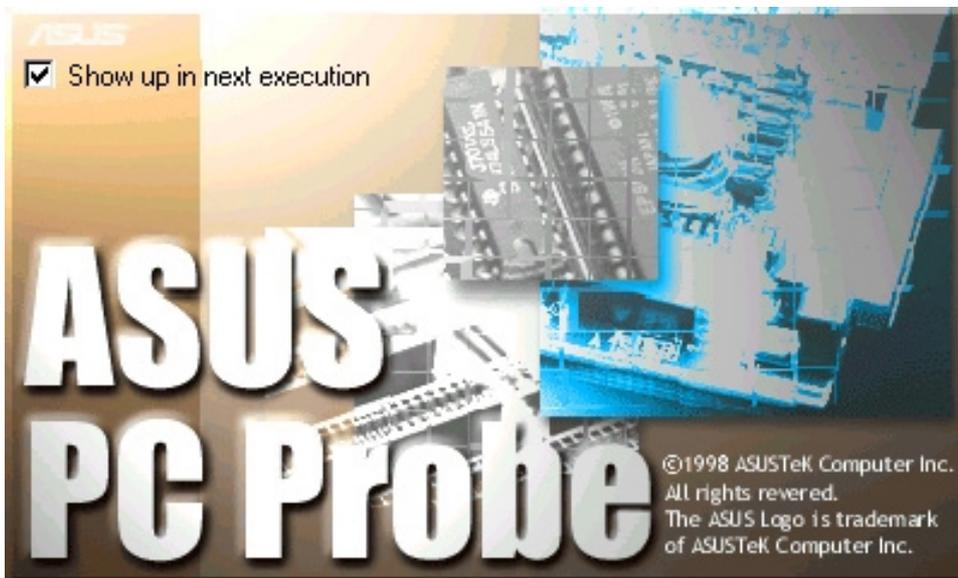

To launch **ASUS PC Probe**, click the Windows **Start** button, point to **Programs**, and then **ASUS Utility**, and then click **Probe Vx.xx**.

The PC Probe icon  appears on the taskbar system tray indicating that ASUS PC Probe is running. Clicking the icon allows you to see the status of your PC.



## Using ASUS PC Probe

### Monitoring

#### Monitor Summary

Shows a summary of the items being monitored.



#### Temperature Monitor

Shows the PC temperature (for supported processors only).

Temperature Warning threshold adjustment  
(Move the slider up to increase the threshold level or down to decrease the threshold level)

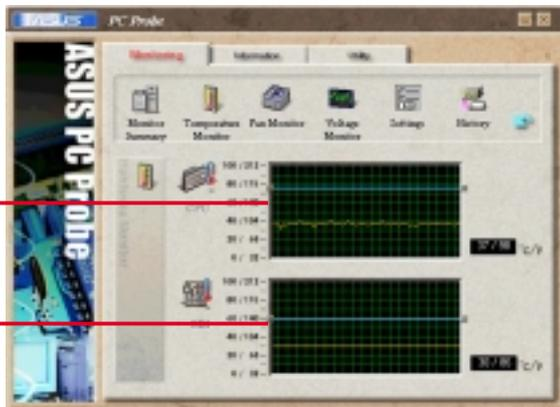

#### Fan Monitor

Shows the PC fan rotation.

Fan Warning threshold adjustment  
(Move the slider up to increase the threshold level or down to decrease the threshold level)

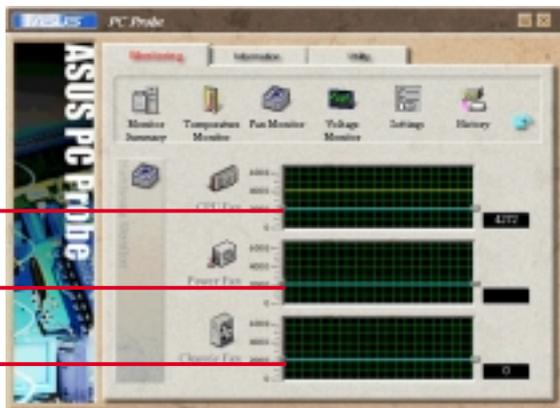

#### Voltage Monitor

Shows the PC voltages.

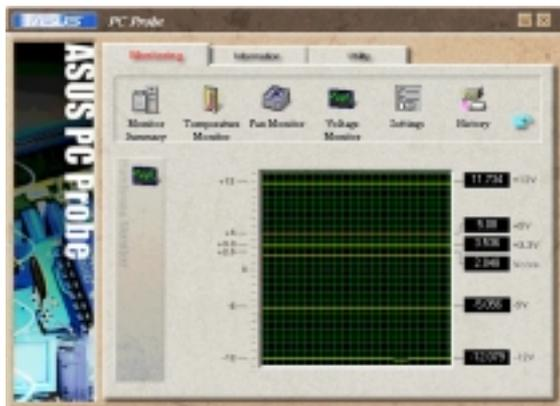

## Settings

Lets you set threshold levels and polling intervals or refresh times of the PC's temperature, fan rotation, and voltages.

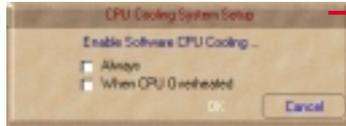

### CPU Cooling System Setup

Lets you select when to enable software CPU cooling. When **When CPU Overheated** is selected, the CPU cooling system is enabled whenever the CPU temperature reaches the threshold value.

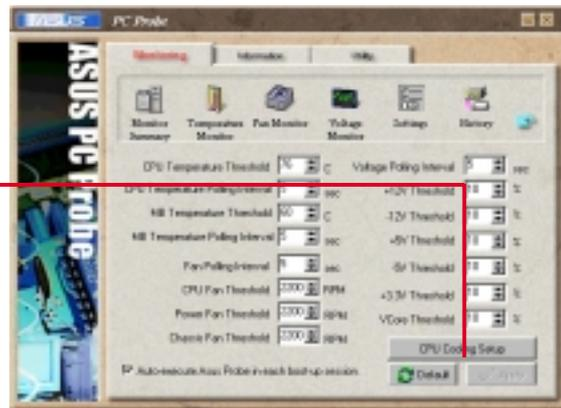

## History

Lets you record the monitoring activity of a certain component of your PC for future reference.

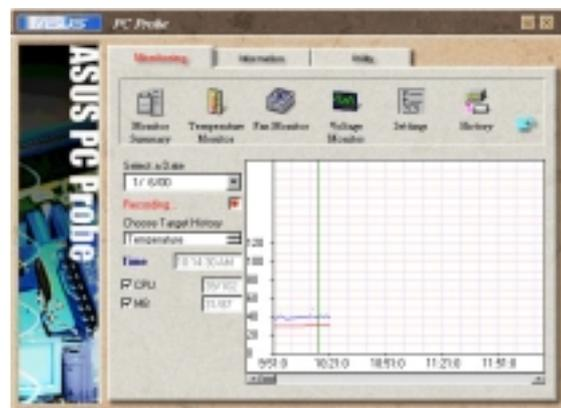

## Fan Control

Lets you enable/disable Smart Fan Control. Smart Fan Control adjusts the fan speed automatically based on the current CPU temperature and predefined threshold.

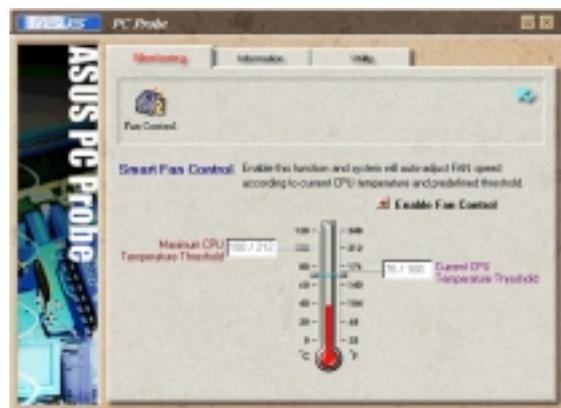

## Hard Drives

Shows the used and free space of the PC's hard disk drives and the file allocation table or file system used.





## Memory

Shows the PC memory load, memory usage, and paging file usage.



## Device Summary

Shows a summary of devices present in your PC.



## DMI Explorer

Shows information pertinent to the PC, such as CPU type, CPU speed, and internal/external frequencies, and memory size.



## Utility

Lets you run programs outside of the ASUS Probe modules. To run a program, click **Execute Program**. **NOTE:** This feature is currently unavailable.

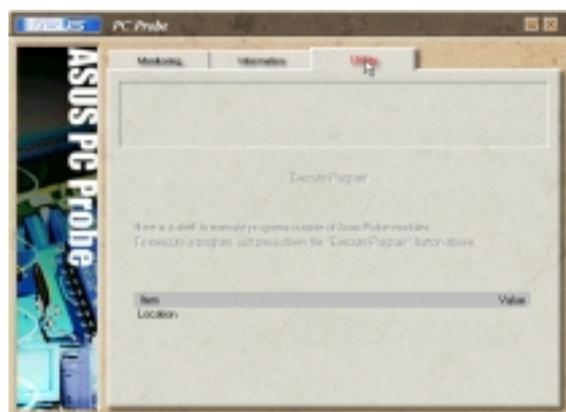

## ASUS PC Probe Task Bar Icon

Right clicking the PC Probe icon brings up a menu to open or exit ASUS PC Probe and pause or resume all system monitoring.



When the ASUS PC Probe senses a problem with your PC, portions of the ASUS PC Probe icon change to red, the PC speaker beeps, and the ASUS PC Probe monitor appears.

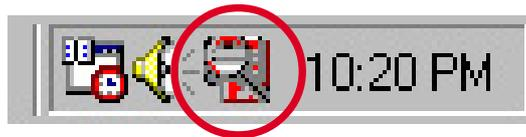

## Free Manuals Download Website

<http://myh66.com>

<http://usermanuals.us>

<http://www.somanuals.com>

<http://www.4manuals.cc>

<http://www.manual-lib.com>

<http://www.404manual.com>

<http://www.luxmanual.com>

<http://aubethermostatmanual.com>

Golf course search by state

<http://golfingnear.com>

Email search by domain

<http://emailbydomain.com>

Auto manuals search

<http://auto.somanuals.com>

TV manuals search

<http://tv.somanuals.com>