



Agilent U2761A USB Modular Function/Arbitrary Waveform Generator

User's Guide



Agilent Technologies

Notices

© Agilent Technologies, Inc., 2008-2009

No part of this manual may be reproduced in any form or by any means (including electronic storage and retrieval or translation into a foreign language) without prior agreement and written consent from Agilent Technologies, Inc. as governed by United States and international copyright laws.

Manual Part Number

U2761-90000

Edition

Third Edition, January 31, 2009

Agilent Technologies, Inc.
3501 Stevens Creek Blvd.
Santa Clara, CA 95052 USA

Trademark Acknowledgements

Pentium is a U.S. registered trademark of Intel Corporation.

Microsoft, Visual Studio, Windows, and MS Windows are trademarks of Microsoft Corporation in the United States and/or other countries.

Warranty

The material contained in this document is provided “as is,” and is subject to being changed, without notice, in future editions. Further, to the maximum extent permitted by applicable law, Agilent disclaims all warranties, either express or implied, with regard to this manual and any information contained herein, including but not limited to the implied warranties of merchantability and fitness for a particular purpose. Agilent shall not be liable for errors or for incidental or consequential damages in connection with the furnishing, use, or performance of this document or of any information contained herein. Should Agilent and the user have a separate written agreement with warranty terms covering the material in this document that conflict with these terms, the warranty terms in the separate agreement shall control.

Technology Licenses

The hardware and/or software described in this document are furnished under a license and may be used or copied only in accordance with the terms of such license.

Restricted Rights Legend

U.S. Government Restricted Rights. Software and technical data rights granted to the federal government include only those rights customarily provided to end user customers. Agilent provides this customary commercial license in Software and technical data pursuant to FAR 12.211 (Technical Data) and 12.212 (Computer Software) and, for the Department of Defense, DFARS 252.227-7015 (Technical Data - Commercial Items) and DFARS 227.7202-3 (Rights in Commercial Computer Software or Computer Software Documentation).

Safety Notices

CAUTION

















A **CAUTION** notice denotes a hazard. It calls attention to an operating procedure, practice, or the like that, if not correctly performed or adhered to, could result in damage to the product or loss of important data. Do not proceed beyond a **CAUTION** notice until the indicated conditions are fully understood and met.

WARNING

A **WARNING** notice denotes a hazard. It calls attention to an operating procedure, practice, or the like that, if not correctly performed or adhered to, could result in personal injury or death. Do not proceed beyond a **WARNING** notice until the indicated conditions are fully understood and met.

Safety Symbols

The following symbols on the instrument and in the documentation indicate precautions which must be taken to maintain safe operation of the instrument.

	Direct current (DC)		Equipment protected throughout by double insulation or reinforced insulation
	Alternating current (AC)		Off (supply)
	Both direct and alternating current		On (supply)
	Three-phase alternating current		Caution, risk of electric shock
	Earth (ground) terminal		Caution, risk of danger (refer to this manual for specific Warning or Caution information)
	Protective conductor terminal		Caution, hot surface
	Frame or chassis terminal		Out position of a bi-stable push control
	Equipotentiality		In position of a bi-stable push control

General Safety Information

The following general safety precautions must be observed during all phases of operation of this instrument. Failure to comply with these precautions or with specific warnings elsewhere in this manual violates safety standards of design, manufacture and intended use of the instrument. Agilent Technologies Inc. assumes no liability for the customer's failure to comply with these requirements.

WARNING

- **Do not operate the product in an explosive atmosphere or in the presence of flammable gases or fumes.**
 - **Do not use the equipment if it does not operate properly. Have the equipment inspected by qualified service personnel(s).**
-

CAUTION

- Observe all markings on the instrument before connecting any wiring to the instrument.
 - Use the device with the cables provided.
 - Repair or service that is not covered in this manual should only be performed by qualified personnel(s).
-

Environment Conditions

This instrument is designed for indoor use and in the area with low condensation. The table below shows the general environmental requirements for this instrument.





Environment conditions	Requirements
Operating temperature	0 °C to 50 °C
Operating humidity	20 to 85% RH non-condensing
Storage temperature	-20 °C to 70 °C
Storage humidity	5 to 90% RH non-condensing

CAUTION

The U2761A USB modular function/arbitrary waveform generator complies with the following safety and EMC requirements.

- IEC 61010-1:2001/EN61010-1:2001 (2nd Edition)
- Canada: CAN/CSA-C22.2 No. 61010-1-04
- USA: ANSI/UL 61010-1:2004
- IEC 61326-2002/EN 61326:1997+A1:1998+A2:2001+A3:2003
- Canada: ICES-001:2004
- Australia/New Zealand: AS/NZS CISPR11:2004

Regulatory Markings

	<p>The CE mark is a registered trademark of the European Community. This CE mark shows that the product complies with all the relevant European Legal Directives.</p>		<p>The C-tick mark is a registered trademark of the Spectrum Management Agency of Australia. This signifies compliance with the Australia EMC Framework regulations under the terms of the Radio Communication Act of 1992.</p>
<p>ICES/NMB-001</p>	<p>ICES/NMB-001 indicates that this ISM device complies with Canadian ICES-001. Cet appareil ISM est conforme à la norme NMB-001 du Canada.</p>		<p>This instrument complies with the WEEE Directive (2002/96/EC) marking requirement. This affixed product label indicates that you must not discard this electrical/electronic product in domestic household waste.</p>
	<p>The CSA mark is a registered trademark of the Canadian Standards Association.</p>		

Waste Electrical and Electronic Equipment (WEEE) Directive 2002/96/EC

This instrument complies with the WEEE Directive (2002/96/EC) marking requirement. This affixed product label indicates that you must not discard this electrical/electronic product in domestic household waste.

Product Category:

With reference to the equipment types in the WEEE directive Annex 1, this instrument is classified as a "Monitoring and Control Instrument" product.

The affixed product label is shown as below:

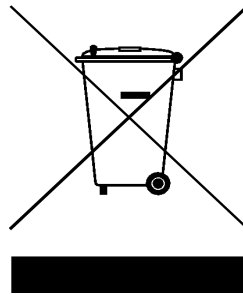

Do not dispose in domestic household waste

To return this unwanted instrument, contact your nearest Agilent office, or visit:

www.agilent.com/environment/product

for more information.

Declaration of Conformity

 Agilent Technologies	DECLARATION OF CONFORMITY According to EN ISO/IEC 17050-1:2004	
---	--	---

Manufacturer's Name: Agilent Technologies Microwave Products (M) Sdn. Bhd
Manufacturer's Address: Bayan Lepas Free Industrial Zone,
11900, Bayan Lepas, Penang, Malaysia

Declares under sole responsibility that the product as originally delivered

Product Name: Agilent USB Modular Function Generator
Models Number: U2761A
Product Options: This declaration covers all options of the above product(s)

complies with the essential requirements of the following applicable European Directives, and carries the CE marking accordingly:

Low Voltage Directive (2006/95/EC)
EMC Directive (2004/108/EC)

and conforms with the following product standards:

EMC	Standard	Limit
	IEC 61326:2002 / EN 61326:1997+A1:1998+A2:2001+A3:2003	
	CISPR 11:1990 / EN55011:1990	Class A Group 1
	IEC 61000-4-2:1995 / EN 61000-4-2:1995	4 kV CD, 8 kV AD
	IEC 61000-4-3:1995 / EN 61000-4-3:1996	3 V/m, 80-1000 MHz
	IEC 61000-4-4:1995 / EN 61000-4-4:1995	0.5 kV signal lines, 1 kV power lines
	IEC 61000-4-5:1995 / EN 61000-4-5:1995	0.5 kV line-line, 1 kV line-ground
	IEC 61000-4-6:1996 / EN 61000-4-6:1996	3 V, 0.15-80 MHz
	IEC 61000-4-11:1994 / EN 61000-4-11:1994	1 cycle / 100%

Canada: ICES-001:2004
Australia/New Zealand: AS/NZS CISPR11:2004

The product was tested in a typical configuration with Agilent Technologies test systems.

Safety IEC 61010-1:2001 / EN 61010-1:2001
Canada: CAN/CSA-C22.2 No. 61010-1-04
USA: ANSI/UL 61010-1:2004



This DoC applies to above-listed products placed on the EU market after:

08-Jan-2008

Date



Tay Eng Su

Quality Manager

For further information, please contact your local Agilent Technologies sales office, agent or distributor,
or Agilent Technologies Deutschland GmbH, Herrenberger Straße 130, 71034 Böblingen, Germany.

Template: A5971-5302-2, Rev. E

U2761A

DoC Revision 1.0

Product Regulations

EMC

IEC 61326-1:2002 / EN 61326-1:1997+A1:1998+A2:2001+A3:2003

Performance Criteria

CISPR 11:1990 / EN 55011:1990 – Group 1 Class A	
IEC 61000-4-2:1995 / EN 61000-4-2:1995 (ESD 4kV CD, 8kV AD)	A
IEC 61000-4-3:1995 / EN 61000-4-3:1996 (3V/m, 80% AM)	A
IEC 61000-4-4:1995 / EN 61000-4-4:1995 (EFT 0.5kV line-line, 1kV line-earth)	B
IEC 61000-4-5:1995 / EN 61000-4-5:1995 (Surge 0.5kV line-line, 1kV line-earth)	A
IEC 61000-4-6:1996 / EN 61000-4-6:1996 (3V, 0.15–80 MHz, 80% AM, power line)	A
IEC 61000-4-11:1994 / EN 61000-4-11:1994 (Dips 1 cycle, 100%)	A
Canada: ICES-001:2004	
Australia/New Zealand: AS/NZS CISPR11:2004	

Safety

IEC 61010-1:2001 / EN 61010-1:2001
Canada: CAN/CSA-C22.2 No. 61010-1-04
USA: ANSI/UL 61010-1:2004

Additional Information:

The product herewith complies with the essential requirements of the Low Voltage Directive 2006/95/EC and the EMC Directive 2004/108/EC and carries the CE Marking accordingly (European Union).

¹Performance Criteria:

A Pass - Normal operation, no effect.
B Pass - Temporary degradation, self recoverable.
C Pass - Temporary degradation, operator intervention required.
D Fail - Not recoverable, component damage.
N/A – Not applicable

Notes:

Regulatory Information for Canada

ICES/NMB-001:2004

This ISM device complies with Canadian ICES-001.

Cet appareil ISM est conforme à la norme NMB-001 du Canada.

Regulatory Information for Australia/New Zealand

This ISM device complies with Australian/New Zealand AS/NZS CISPR11:2004

 N10149

In This Guide...

1 Getting Started

In this chapter, you prepare your system for installation and configuration to get started with the U2761A.

2 Features and Functions

In this chapter, you will learn about the functions and features offered by the U2761A.

3 Characteristics and Specifications

In this chapter, you will observe the product characteristics and specifications.

Contents

1	Getting Started	1
	Introduction	2
	Product at a Glance	3
	Product Outlook	3
	Product Dimensions	5
	Dimensions Without Bumpers	5
	Dimensions With Bumpers	6
	Standard Purchase Items	7
	Inspection and Maintenance	8
	Initial Inspection	8
	Electrical Check	8
	General Maintenance	8
	Installation and Configuration	9
	Installation	9
	A. Check Your System	10
	B. Install the IO Libraries Suite	11
	C. Install the Module Driver	12
	D. Install the Agilent Measurement Manager	13
	E. Connect the Module to Your PC	15
	F. Verify Your Module Connection	19
	G. Launch Your Agilent Measurement Manager	21
	55-Pin Backplane Connector Pin Configuration	23
	Chassis Installation	24
2	Features and Functions	25
	Output Configuration	26
	Introduction	26
	Output Function	26

Output Frequency	29
Output Amplitude	31
DC Offset Voltage	33
Output Units	35
Output Termination	36
Duty Cycle (Square Waves)	38
Symmetry (Ramp Wave)	40
Output Control	41
Set Output Using SCPI Commands	42
Pulse Waveform	45
Pulse Period	45
Pulse Width	46
Pulse Duty Cycle	47
Generate Pulse Waveform Using SCPI Commands	48
Amplitude Modulation (AM)	49
To Select AM	49
Carrier Waveform	50
Carrier Frequency	51
Modulating Waveform	52
Modulating Waveform Frequency	53
Modulation Depth	53
Generate AM Using SCPI Commands	54
Frequency Modulation (FM)	55
To Select FM	55
Carrier Waveform	56
Carrier Frequency	57
Modulating Waveform	58
Modulating Waveform Frequency	59
Frequency Deviation	59
Generate FM Using SCPI Commands	60
Phase Modulation (PM)	61

To Select PM	61
Carrier Waveform	62
Carrier Frequency	63
Modulating Waveform	64
Modulating Waveform Frequency	64
Phase Deviation	65
Generate PM Using SCPI Commands	65
Frequency-Shift Keying (FSK) Modulation	66
To Select FSK Modulation	66
Carrier Waveform	67
FSK Carrier Frequency	68
FSK "Hop" Frequency	69
Generate FSK Modulation Using SCPI Commands	70
Phase-Shift Keying (PSK) Modulation	71
To Select PSK Modulation	71
Carrier Waveform	72
PSK Carrier Frequency	73
PSK Rate	74
PSK Deviation	74
Generate PSK Modulation Using SCPI Commands	75
Amplitude-Shift Keying (ASK) Modulation	76
To Select ASK Modulation	76
Carrier Waveform	77
Carrier Frequency	78
ASK Rate	79
Generate ASK Modulation Using SCPI Commands	79
Frequency Sweep	80
To Select Sweep	80
Start Frequency and Stop Frequency	81
Sweep Mode	82
Sweep Time	82

Sweep Trigger Source	83
Set Frequency Sweep Using SCPI Commands	84
Triggering	85
Trigger Source Choices	85
Internal Triggering	86
Manual Triggering	86
External Triggering	87
Trigger Input Signal	88
Trigger Output Signal	88
Set Triggering Using SCPI Commands	90
Arbitrary Waveforms	91
To Create and Store an Arbitrary Waveform	91
3 Characteristics and Specifications	95
Product Characteristics	96
Product Specifications and Characteristics	97
Index	103

List of Figures

- Figure 1-1 55-pin backplane connector pin configuration 23
- Figure 2-1 U2761A soft front panel 28
- Figure 2-2 Top panel view of the U2761A 29
- Figure 2-3 Panel view of the frequency section 30
- Figure 2-4 Panel view of the amplitude section 32
- Figure 2-5 Panel view of the DC offset section 34
- Figure 2-6 Panel view of the Tools menu 37
- Figure 2-7 Square wave duty cycles 38
- Figure 2-8 Panel view of the duty cycle section 39
- Figure 2-9 Ramp wave duty cycles 40
- Figure 2-10 Panel view of the symmetry section 40
- Figure 2-11 Panel view of the output section 41
- Figure 2-12 Pulse waveform 45
- Figure 2-13 Panel view of the pulse width section 46
- Figure 2-14 AM waveform 49
- Figure 2-15 Panel view of AM 50
- Figure 2-16 Panel view of the Arbitrary waveform 51
- Figure 2-17 FM waveform 55
- Figure 2-18 Panel view of FM 56
- Figure 2-19 PM waveform 61
- Figure 2-20 Panel view of PM 62
- Figure 2-21 FSK modulation waveform 66
- Figure 2-22 Panel view of FSK 67
- Figure 2-23 PSK modulation waveform 71
- Figure 2-24 Panel view of PSK 72
- Figure 2-25 ASK modulation waveform 76
- Figure 2-26 Panel view of ASK 77
- Figure 2-27 Frequency sweep 80
- Figure 2-28 Panel view of sweep 81
- Figure 2-29 Trigger input pulse 88

- Figure 2-30 Trigger output pulse 88
- Figure 2-31 Ramp waveform 91
- Figure 2-32 Waveform download in progress 93

List of Tables

Table 1-1	Synchronous Simultaneous Interface (SSI) connector pin description	23
Table 2-1	Output functions	26
Table 2-2	Output frequency range	29
Table 2-3	Carrier frequency for AM	51
Table 2-4	Carrier frequency for FM	57
Table 2-5	Carrier frequency for PM	63
Table 2-6	Carrier frequency for FSK	68
Table 2-7	“Hop” frequency	69
Table 2-8	Carrier frequency for PSK	73
Table 2-9	Carrier frequency for ASK	78



1 Getting Started

Introduction	2
Product at a Glance	3
Product Dimensions	5
Standard Purchase Items	7
Inspection and Maintenance	8
Installation and Configuration	9

This chapter provides the introduction of the U2761A that helps you get acquainted with the product and the product outlook. This chapter also includes the installation and configuration procedures that will help you get started with the U2761A.



Introduction

The U2761A is a 20 MHz USB modular function generator with Arbitrary waveform and pulse generation capabilities. It can operate as a standalone unit or as part of a modular unit when used with the U2781A USB modular instrument chassis.

The U2761A adopts the latest direct digital synthesis (DDS) technology that digitally creates Arbitrary waveforms and frequencies from a single, fixed source frequency. DDS offers the precision of a digital control logic; reducing the complexity of the generator while increasing the stability. Thus, creating a stable, accurate output signal for clean, low distortion sine waves with fast rise and fall time up to 20 MHz and linear Ramp waves up to 200 kHz.

Various features of the U2761A

- 20 MHz Sine and Square waveforms
- Hi-Speed 2.0, USBTMC 488.2 standards
- Sine, Square, Ramp, Triangle, Pulse, and DC waveforms
- 14-bit, 50 MSa/s, 64 K-point Arbitrary waveforms
- AM, FM, PM, ASK, FSK, and PSK modulation types
- 40 mVpp to 5 Vpp amplitude range for 50 Ω load, and 80 mVpp to 10 Vpp amplitude range for open circuit
- Pulse generation

Product at a Glance

Product Outlook

Top View

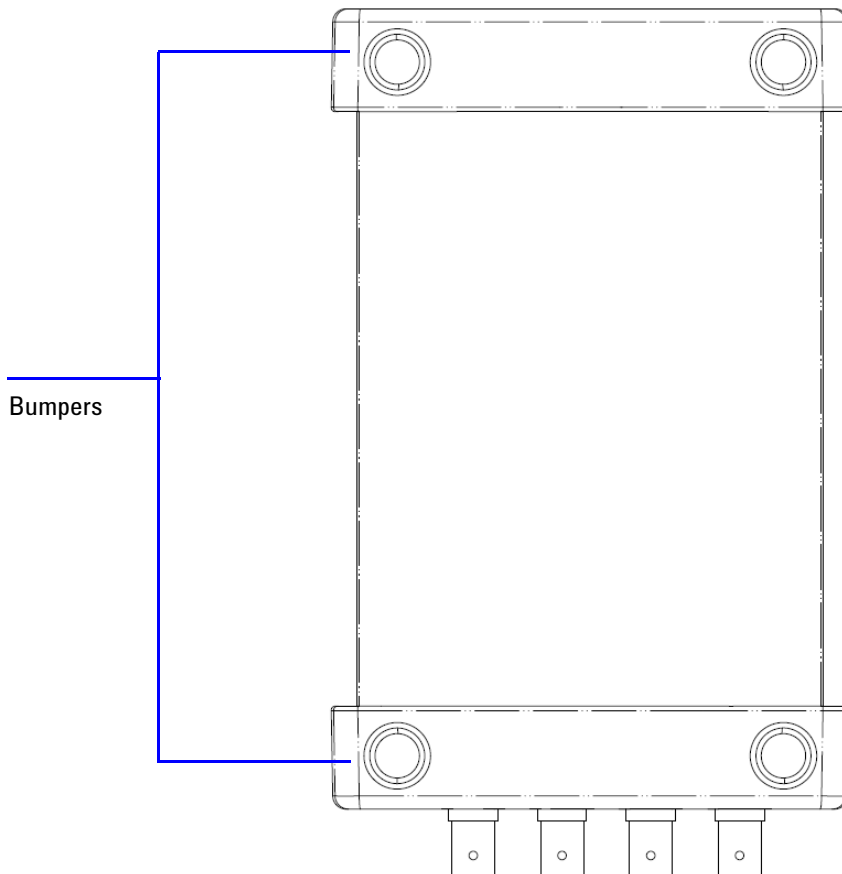

1 Getting Started

Front View

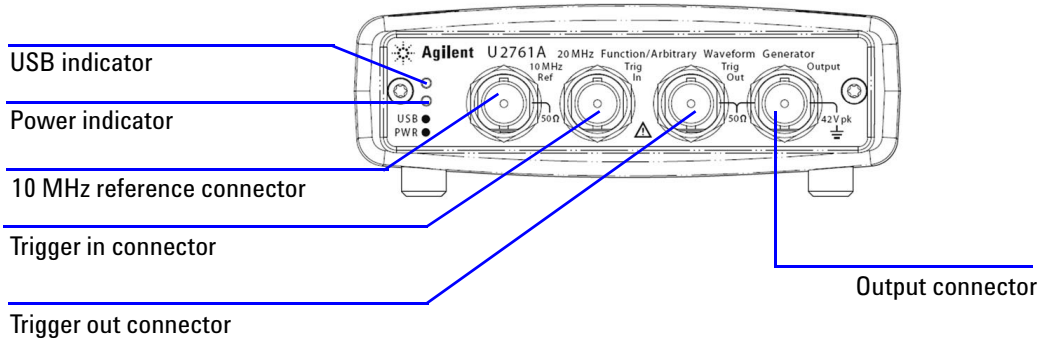

Rear View

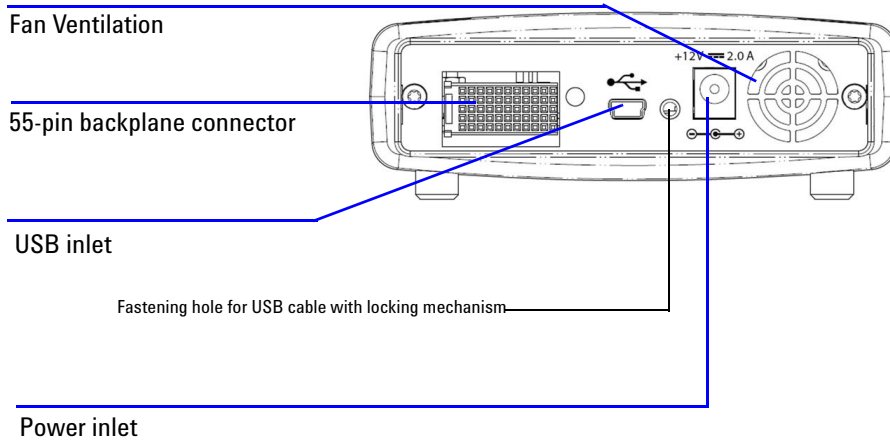

Product Dimensions

Dimensions Without Bumpers

Top View

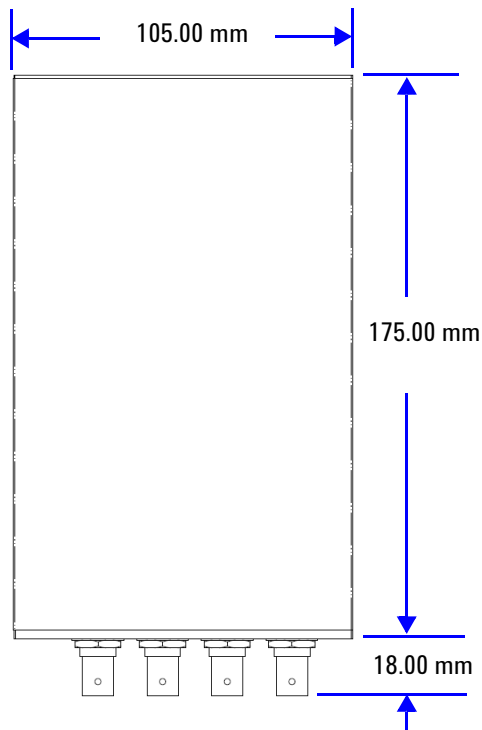

Front View

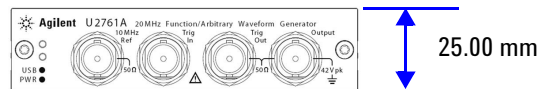

Dimensions With Bumpers

Top View

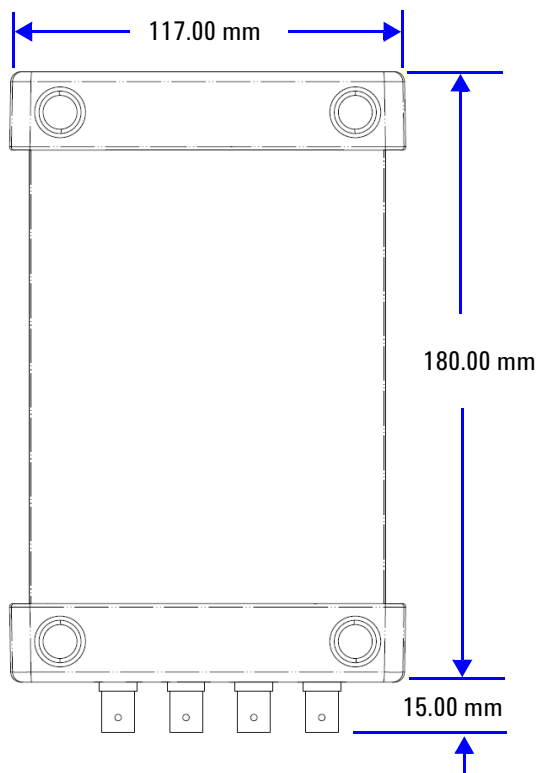

Front View

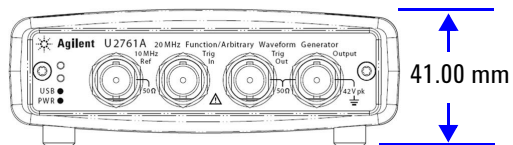

Standard Purchase Items

Verify the following items for the standard purchase of the U2761A. If there are any missing or mechanically damaged items, contact the nearest Agilent Sales Office.

- ✓ 12 V, 2 A AC/DC power adapter
- ✓ Power cord
- ✓ USB Standard-A to Mini-B interface cable
- ✓ L-Mount kit (used with modular instrument chassis)
- ✓ Agilent Automation-Ready CD (contains the IO Libraries Suite)
- ✓ Agilent USB Modular Products Quick Start Guide
- ✓ Agilent USB Modular Products Reference CD-ROM
- ✓ Agilent Measurement Manager Quick Reference Card
- ✓ Certificate of Calibration

Inspection and Maintenance

Initial Inspection

When you receive your U2761A, inspect the unit for any obvious damage such as broken terminals or cracks, dents, and scratches on the casing that may occur during shipment. If any damage is found, notify the nearest Agilent Sales Office immediately. The front of this manual contains the warranty information.

Keep the original packaging in case the U2761A has to be returned to Agilent in the future. If you return the U2761A for service, attach a tag identifying the owner and model number. Also include a brief description of the problem.

Electrical Check

The *U2761A USB Modular Function/Arbitrary Waveform Generator Service Guide* will provide the complete verification and calibration procedures. The procedures will verify to a high level of confidence that the U2761A is operating in accordance with its specifications.

General Maintenance

NOTE

Any repair that is not covered in your modular product manuals should only be performed by qualified personnel.

- 1 Power off your module and remove the power cord and I/O cable from your device.
- 2 Remove your module from the bumper casing.
- 3 Shake off any dirt that may have accumulated on the module.
- 4 Wipe your module with a dry cloth and install the bumper back in place.

Installation and Configuration

Installation

Follow the step-by-step instructions shown in the following flowchart to get started with the preparations and installations of your U2761A.

NOTE

You need to install the IVI-COM driver if you are going to use the U2761A with Agilent VEE Pro, LabVIEW, or Microsoft® Visual Studio®.

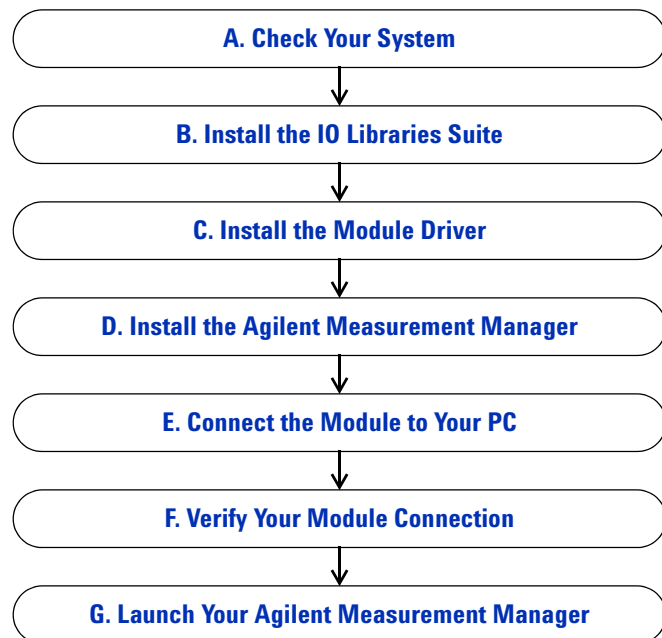

A. Check Your System

Prior to any installation or configuration, please ensure that your PC meets the following minimum system requirements.

Processor 1.6 GHz Pentium® IV or higher

Operating system Windows® XP Professional or Home Edition (Service Pack 1 or later), or Windows® 2000 Professional (Service Pack 4 or later)

Browser Microsoft® Internet Explorer 5.01 or higher

Available RAM 512 MB or higher recommended

Hard-disk space 1 GB

Video Super VGA 800×600 (1024×768 recommended)

Prerequisites Agilent IO Libraries Suite 14.2 or higher (version 15.0¹ recommended), Agilent T&M Toolkit Runtime version 2.1², Agilent T&M Toolkit Redistributable Package 2.1 patch², Microsoft® .NET Framework version 1.1 and 2.0²

1 Available on *Agilent Automation-Ready CD*.

2 Bundled with Agilent Measurement Manager application software installer.

B. Install the IO Libraries Suite

The IO Libraries Suite 14.2 or higher is available on the *Agilent Automation-Ready CD* that comes with the standard purchase of the U2761A.

NOTE

- If you do not have the *Agilent Automation-Ready CD*, obtain the IO Libraries Suite 14.2 or higher at <http://www.agilent.com/find/iolib>.
- Disconnect any USB instruments or connectivity interface from your PC.

- 1 Close all other applications on your PC, insert the *Agilent Automation-Ready CD* into your CD-ROM drive, and follow the instructions on your screen.
- 2 If the IO Libraries Suite installation does not start automatically, go to **Start > Run** (on the Windows Start menu) and type <drive>:\autorun\auto.exe where <drive> is your CD-ROM drive location.
- 3 If you obtain the IO Libraries Suite from the web, save the self-extracting zip file (*.exe) to any location on your hard disk.
- 4 Double-click the installation file to launch the installation.
- 5 Follow the instructions on your screen to proceed with the installation.
- 6 After the installation has completed, you will see the IO Control icon on the Windows taskbar notification area as shown below.



NOTE

For detailed installation instructions, refer to the *Agilent IO Libraries Suite Getting Started Guide* at <http://www.agilent.com/find/iolib>.

C. Install the Module Driver

NOTE

Please ensure that there are no instruments connected to the PC when installing the driver.

- 1 Verify that your PC meets the minimum system requirements as stated in “A. Check Your System” on page 10.
- 2 Insert the *Product Reference CD-ROM* into your CD-ROM drive.
- 3 The installer will automatically launch the **Agilent Modular Products Installation Menu**. Click **Hardware Driver** to begin the installation.

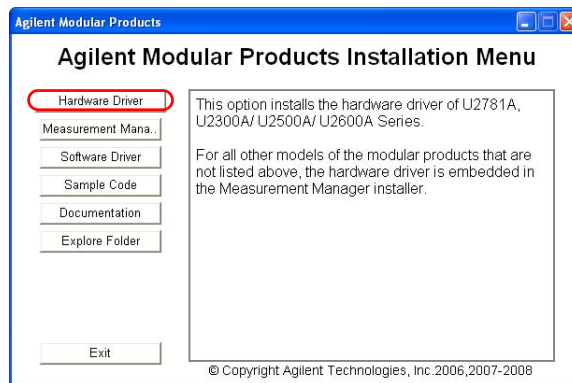

- 4 If the menu does not launch automatically, go to **Start > Run** (on the Windows Start menu) and type `<drive>:\Driver\Hardware\setup_Hw.exe` where `<drive>` is your CD-ROM drive location. Click **OK** to begin the installation.
- 5 Follow the instructions on the screen and click **Next** to proceed.

- 6 Click **Install** to begin the installation. Follow the instructions on the screen to proceed with the installation.
- 7 Click **Finish** when the installation has completed.

D. Install the Agilent Measurement Manager

- 1 If you have done “C. Install the Module Driver” on page 12, proceed to Step 2. If not, close all other applications on your PC and insert the *Product Reference CD-ROM* into your CD-ROM drive.
- 2 Click **Measurement Manager** on the **U2761A Installation Menu** to begin the installation.

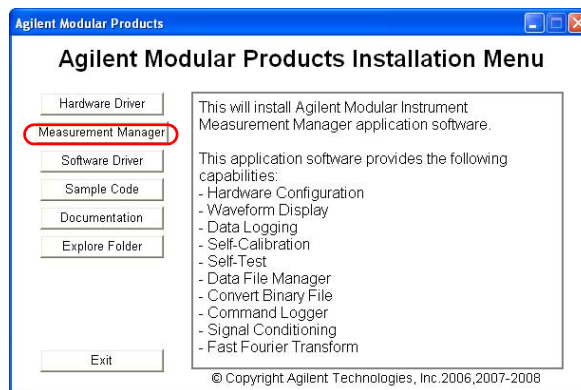

- 3 If the installation menu does not appear after a few seconds, go to **Start > Run** and type `<drive>:\Application\Modular Instruments Measurement Manager\setup.exe` where `<drive>` is your CD-ROM drive location.
- 4 Click **OK** to begin the installation.
- 5 If you do not have any of the prerequisites installed, the InstallShield Wizard software prerequisite will appear.

- 6 Click **OK** to begin the installation of the listed missing prerequisites.
- 7 Once the above installation has completed, installation of the Measurement Manager software will proceed as normal.
- 8 The **Measurement Manager InstallShield Wizard** dialog will appear. Click **Next** to begin.
- 9 Read the License Agreement and select **I accept the terms in the License Agreement** to proceed. You may click **Print** to print a hardcopy of the Agilent License Terms for reference. Click **Next** to proceed.
- 10 Fill in the Customer Information Form accordingly and click **Next**.
- 11 Click **Next** to install to the specified folder or click **Change** to install to a different folder.
- 12 Click **Install** to begin the installation of the Measurement Manager.
- 13 Click **Finish** when the installation has completed.
- 14 A shortcut to this software will be created on your desktop.

NOTE

USING THE LICENSED MATERIALS INDICATES YOUR ACCEPTANCE OF THE LICENSE TERMS. IF YOU DO NOT AGREE TO ALL OF THESE TERMS, YOU MAY RETURN ANY UNOPENED LICENSED MATERIAL FOR A FULL REFUND. IF THE LICENSED MATERIALS ARE BUNDLED OR PRELOADED WITH ANOTHER PRODUCT, YOU MAY RETURN THE ENTIRE UNUSED PRODUCT FOR A FULL REFUND.

E. Connect the Module to Your PC

NOTE

Ensure that the Agilent Measurement Manager is installed before proceeding.

- 1 After the installations have completed, connect the power cord to the AC/DC power adapter. The AC/DC power adapter requirements are 100 to 240 VAC, 50/60 Hz, with an output voltage of +12 VDC.
- 2 Insert the DC output plug from the AC/DC power adapter to the power jack on the rear panel of the U2761A.
- 3 Connect the U2761A to any USB port on your PC with the bundled USB cable.
- 4 Your PC will automatically detect the connected unit and the **Found New Hardware Wizard** window will appear. Select **Yes, this time only** and click **Next** to proceed.



- 5 Select **Install the software automatically (Recommended)** and click **Next**.



- 6 A warning message will appear on the **Hardware Installation** window. Click **Continue Anyway** to proceed with the installation of the U2761A.



NOTE

If you do not wish to receive similar warning messages in the future, follow the instructions below.

- Go to **Start > Control Panel** and double-click **System**.
- Select the **Hardware** tab and click **Driver Signing** on the **Drivers** panel. The **Driver Signing Options** dialog box will appear.
- Select **Ignore** to disable the warning message.

7 Click **Finish** to complete the installation.

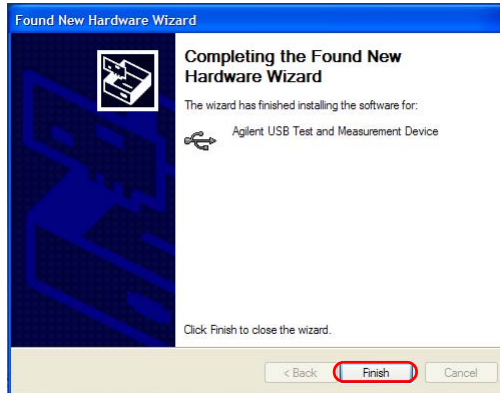

- 8 The **Assign USB device alias** window will appear. Each time the U2761A is plugged in, this dialog box will appear. To disable this dialog, select the **Never show this dialog** option in the **Show this dialog** panel and click **OK**.

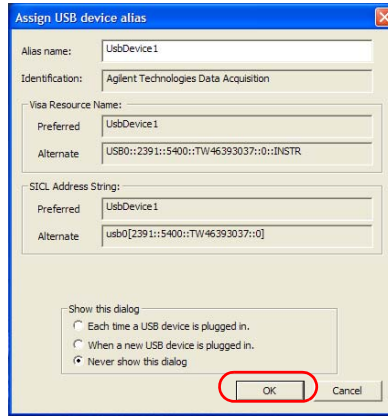

- 9 For modules other than the U2300A Series, U2500A Series, U2600A Series, and U2781A, the system will perform a firmware version check on your connected module.
- a If the module firmware version is the same as the installed version on the PC, it will not perform any firmware download and the U2761A is now ready for use.
 - b If the module firmware version differs from the installed version on the PC, the following message box will appear. Firmware versions (V1.00 and V1.01) in the figure are for illustration purpose only, it might vary depending on the device and PC firmware version.

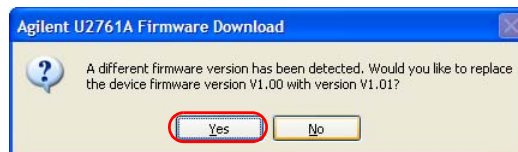

- c Click **Yes** to begin the firmware download. The following message box will appear indicating the download in progress.

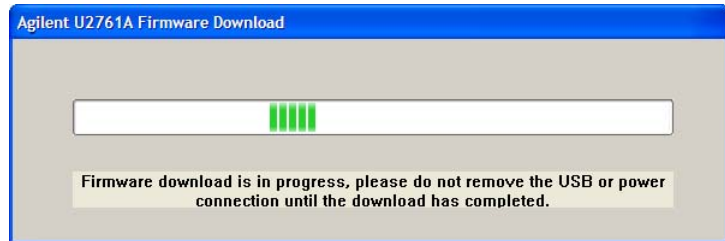

NOTE

Ensure that you do not remove the USB and power connection until the firmware download has completed.

- d Your U2761A is ready for use once the firmware download has completed.

F. Verify Your Module Connection

The Agilent Connection Expert is one of the utilities in the IO Libraries. The Connection Expert configures the connected instruments and enables communication. It is able to automatically detect the U2761A devices plugged into the PC.

- 1 Go to **Start > All Programs > Agilent IO Libraries Suite > Agilent Connection Expert** to launch the Connection Expert.
- 2 The detected U2761A will be visible on the **Instrument I/O on this PC** explorer pane. Right-click on the U2761A instrument on the explorer pane.

1 Getting Started

- 3 A context menu will appear as shown below and select **Send Commands To This Instrument**.

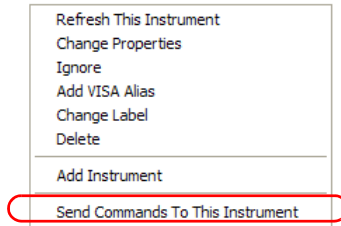

- 4 The **Agilent Interactive IO** dialog box will appear. Click **Send & Read** to send the *IDN? default command. The instrument's response should appear in the **Instrument Session History** panel.

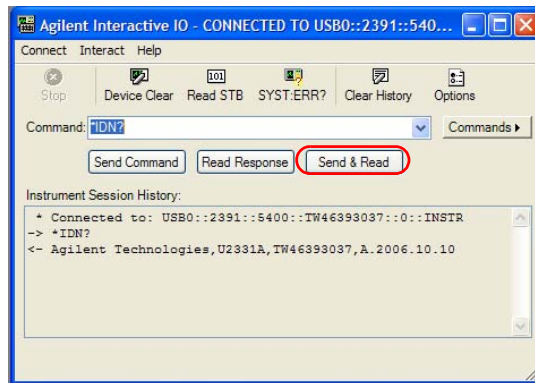

- 5 If the Connection Expert can successfully communicate with the U2761A, this indicates that the instrument is installed correctly.

G. Launch Your Agilent Measurement Manager

NOTE

- The IO Control will launch automatically when you start your PC.
- Launching the Measurement Manager without the IO Control running will cause failure of the Measurement Manager to detect or establish any connection with the U2761A connected to your PC.
- To run the IO Control, go to **Start > All Programs > Agilent IO Libraries Suite > Utilities > IO Control**.

- 1 Double-click the Measurement Manager software icon on your desktop or go to **Start > All Programs > Agilent > Modular Products > Agilent Measurement Manager** to launch the software.
- 2 The Measurement Manager welcome screen will appear.



1 Getting Started

- 3 The **Select USB Device** dialog box will appear displaying the connected U2761A devices. To start the application, select a U2761A device and click **OK** to establish the connection.

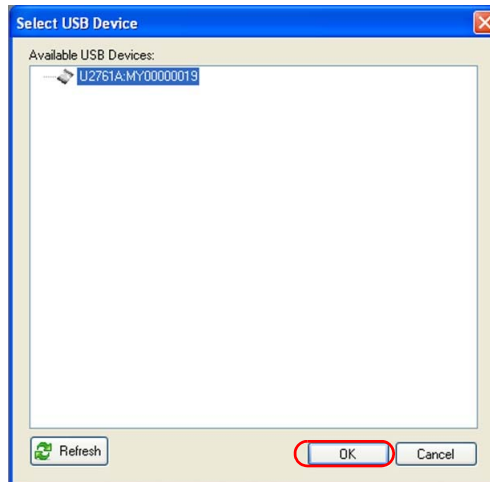

NOTE

For more information on how to use the Measurement Manager, refer to the *Agilent Measurement Manager help file*.

55-Pin Backplane Connector Pin Configuration

The 55-pin backplane connector is used when the U2761A module is inserted into the U2781A USB modular instrument chassis. For more details, refer to the *Agilent U2781A USB Modular Instrument Chassis User's Guide*.

GND	GND	GND	GND	GND	GND	GND	GND	GND	GND	GND	F
NC	NC	NC	NC	NC	NC	NC	NC	VBUS	GND	USB_D-	E
GND	TRIG3	GND	TRIG2	GND	TRIG1	GND	TRIG0	GND	GND	USB_D+	D
TRIG4	GND	TRIG5	GND	TRIG6	GND	TRIG7	GND	+12 V	+12 V	GND	C
nBPUB	CLK10M	GND	STAR_TRIG	GA2	GA1	GA0	NC	+12 V	+12 V	+12 V	B
NC	NC	NC	NC	NC	NC	NC	NC	+12 V	+12 V	+12 V	A
11	10	9	8	7	6	5	4	3	2	1	

Figure 1-1 55-pin backplane connector pin configuration

Table 1-1 Synchronous Simultaneous Interface (SSI) connector pin description

SSI timing signal	Functionality
GND	Ground
NC	Not connected
VBUS	USB bus power sensing input
USB_D+, USB_D-	USB differential pair
TRIG0~TRIG7	Trigger bus
+12 V	+12 V power with 4 A current
nBPUB	USB backplane input detect
CLK10M	10 MHz clock source
STAR_TRIG	Star trigger
GA0,GA1,GA2	Geographical address pin

Chassis Installation

The L-mount kit is to be installed to your U2761A module. The following instructions describe the simple procedure of installing the L-mount kit and your module in the U2781A chassis.

- 1 Unpack the L-mount kit from its packaging.
- 2 Remove your U2761A module from the bumper casing.
- 3 Using a Phillips screwdriver, fasten the L-Mount kit to your U2761A module.
- 4 Insert your U2761A module into the U2781A chassis with the 55-pin backplane connector positioned at the bottom of the module.
- 5 Once you have slotted the module into the chassis, tighten the screws of the L-mount kit to secure the connection.

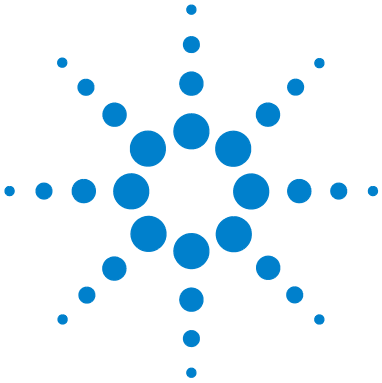

2 Features and Functions

Output Configuration	26
Pulse Waveform	45
Amplitude Modulation (AM)	49
Frequency Modulation (FM)	55
Phase Modulation (PM)	61
Frequency-Shift Keying (FSK) Modulation	66
Phase-Shift Keying (PSK) Modulation	71
Amplitude-Shift Keying (ASK) Modulation	76
Frequency Sweep	80
Triggering	85
Arbitrary Waveforms	91

In this chapter, you will learn about the functions and features offered by the U2761A.



Output Configuration

Introduction

This section contains the information to help you configure the U2761A for outputting waveforms. You may not need to change some of the parameters discussed here, but they are provided so that you will have accessibility when needed.

Output Function

The U2761A can output five standard waveforms (Sine, Square, Ramp, Triangle, and Pulse), and DC. You can select one of the three built-in Arbitrary waveforms or create your own custom waveforms. In addition, you can internally modulate Sine, Square, Ramp, Triangle, and Arbitrary waveforms using AM, FM, PM, FSK, PSK, or ASK. The linear or logarithmic frequency sweeping is available for Sine, Square, Ramp, Triangle, and Arbitrary waveforms.

The table below shows which output functions are allowed with modulation and sweep. Each “V” indicates a valid combination. If you change to a function that is not applicable for modulation, or sweep; then the modulation or mode will be disabled.

Table 2-1 Output functions

	Sine	Square	Ramp	Triangle	Pulse	DC	Arbitrary
AM, FM, PM, FSK, PSK, ASK Carrier	V	V	V	V			V
AM, FM, PM Internal Modulation	V	V	V	V			V
FSK, PSK, ASK Internal Modulation		V					
Sweep Mode	V	V	V	V			V

Function Limitation

If you change to a function where the maximum frequency is less than the current function, the frequency will be adjusted to the maximum value for the new function.

For example, if you are currently outputting a 20 MHz sine wave and then change to the Ramp function, the U2761A will automatically adjust the output frequency to 200 kHz (the upper limit for Ramp).

Amplitude Limitation

If you change to a function where the maximum amplitude is less than the current function, the amplitude will automatically be adjusted to the maximum value for the new function. This may occur when the output units are Vrms or dBm due to the differences in crest factor for the various output functions.

For example, if you output a 2.5 Vrms Square wave (into 50 Ω) and then change to the Sine wave function, the U2761A will automatically be adjusted the output amplitude to 1.768 Vrms (the upper limit for Sine wave in Vrms).

Soft Front Panel Operation

The following figure shows the soft front panel of the U2761A.

Waveform pattern selection

Waveform parameters

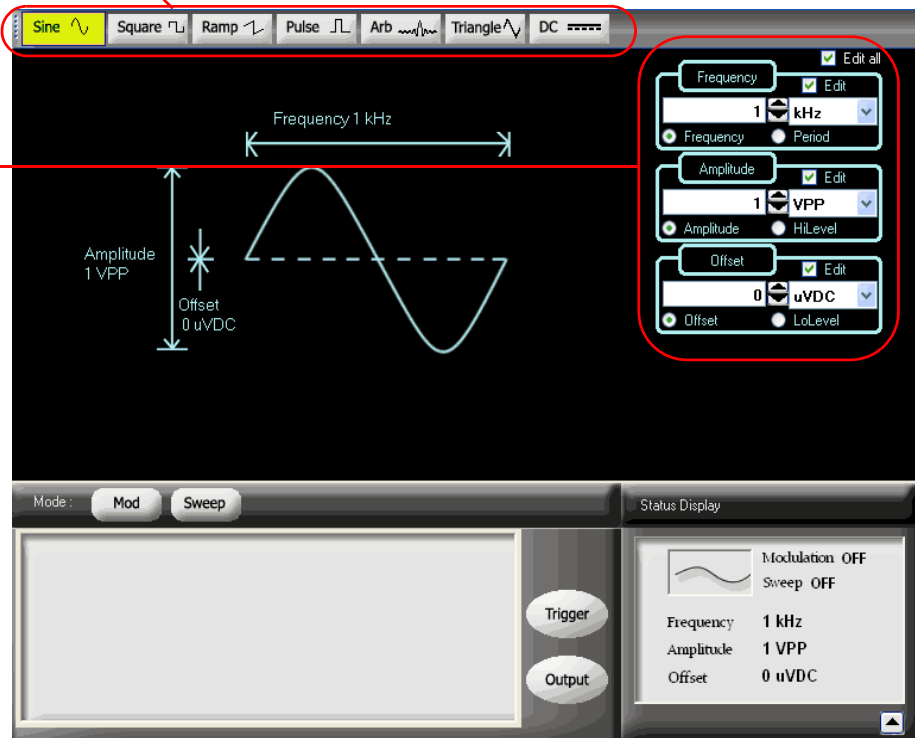



Figure 2-1 U2761A soft front panel

To select a function, click any of the functions on the top panel as shown below. When a function is selected, the button will be illuminated.



Figure 2-2 Top panel view of the U2761A

Click **Arb**  to output the Arbitrary waveform. Select other Arbitrary waveform choices from the drop down list .

Remote Interface Operation

```
FUNCTION {SINusoid|SQUare|RAMP|PULSe|DC|USER}
```

You can also use the APPLY command to select the function, frequency, amplitude, and offset.

Output Frequency

As shown below, the output frequency range depends on the function currently selected. *The default frequency is 1 kHz for all functions.*

Table 2-2 Output frequency range

Function	Minimum frequency	Maximum frequency
Sine	1 μ Hz	20 MHz
Square	1 μ Hz	20 MHz
Ramp, Triangle	1 μ Hz	200 kHz
Pulse	500 μ Hz	5 MHz
DC	Not applicable	Not applicable
Arbitrary	1 μ Hz	200 kHz

Function Limitations

If you change to a function where the maximum frequency is less than the current function, the frequency will be adjusted to the maximum value for the new function.

For example, if you are currently outputting a 20 MHz sine wave and then change to the Ramp function, the U2761A will automatically adjust the output frequency to 200 kHz (the upper limit for Ramp).

Duty Cycle Limitations

For Square waveforms, the U2761A may not be able to use the full range of duty cycle values at higher frequencies as shown below.

- 20% to 80% (frequency \leq 10 MHz)
- 40% to 60% (frequency $>$ 10 MHz)

If you change to a frequency that cannot produce the current duty cycle, the duty cycle is automatically adjusted to the maximum value for the new frequency.

For example, if you currently have the duty cycle set to 70% and then change the frequency to 12 MHz, the U2761A will automatically adjust the duty cycle to 60% (the upper limit for this frequency).

Soft Front Panel Operation

On the Frequency panel as shown in [Figure 2-3](#), input the desired frequency value and select the unit from the drop down list. To set the waveform period instead, select **Period**

Period .



Figure 2-3 Panel view of the frequency section

Remote Interface Operation

FREQuency <frequency>

You can also use the APPLy command to select the function, frequency, amplitude, and offset.

Output Amplitude

The default amplitude is 1 Vpp (into 50 Ω) for all functions.

Offset Voltage Limitations

The relation between the output amplitude and offset voltage is shown below. V_{max} is the maximum peak voltage for the selected output termination (5 V for a 50 Ω load or 10 V for a high-impedance load).

$$V_{pp} \leq 2 \times (V_{max} - |V_{offset}|)$$

Limits Due to Output Termination

If you change the output termination setting, the value of the output amplitude will be adjusted (and no error will be generated).

For example, if you set the amplitude to 5 Vpp and then change the output termination from 50 Ω to “high impedance”, the amplitude value will double to 10 Vpp. If you change from “high impedance” to 50 Ω, the displayed amplitude value will drop to half. For more information, see [“Output Termination”](#) on page 36.

Limits Due to Units Selection

In some cases, the amplitude limits are determined by the output units selected. This may occur when the units are Vrms or dBm due to the differences in crest factor for the various output functions.

For example, if you output a 2.5 Vrms Square wave (into 50 Ω) and then change to the Sine wave function, the U2761A will automatically adjust the output amplitude to 1.768 Vrms (the upper limit for Sine wave in Vrms).

You can set the output amplitude in Vpp, Vrms, or dBm. For more information, see “Output Units” on page 35.

You cannot specify the output amplitude in dBm if the output termination is set to “high impedance”.

Soft Front Panel Operation

On the Amplitude panel as shown in [Figure 2-4](#), input the desired amplitude value and select the unit from the drop down list.



Figure 2-4 Panel view of the amplitude section

Remote Interface Operation

VOLTage <amplitude>

Or, you can set the amplitude by specifying a high level and low level using the following commands.

VOLTage:HIGH <voltage>

VOLTage:LOW <voltage>

You can also use the APPLy command to select the function, frequency, amplitude, and offset.

DC Offset Voltage

The default offset is 0 V for all functions.

Limits Due to Amplitude

The relation between the offset voltage and output amplitude is shown below. V_{max} is the maximum peak voltage for the selected output termination (5 V for a 50 Ω load or 10 V for a high-impedance load).

$$|V_{offset}| \leq V_{max} - \frac{V_{pp}}{2}$$

If the specified offset voltage is not valid, the U2761A will automatically adjust it to the maximum DC voltage allowed with the specified amplitude.

Soft Front Panel Operation

On the Offset panel as shown in [Figure 2-5](#), input the desired offset value and select the unit from the drop down list.



Figure 2-5 Panel view of the DC offset section

Remote Interface Operation

```
VOLTage:OFFSet <offset>
```

Or, you can set the offset by specifying a high level and low level using the following commands.

```
VOLTage:HIGH <voltage>
```

```
VOLTage:LOW <voltage>
```

You can also use the `APPLY` command to select the function, frequency, amplitude, and offset.

Output Units

This configuration applies to output amplitude only. At power-on, the units for output amplitude are volts peak-to-peak.

- The output units consist of Vpp, Vrms, or dBm. *The default unit is Vpp.*
- The unit setting is stored in volatile memory. The units are set to “Vpp” upon power-off or after a remote interface reset.
- The output units for amplitude cannot be set to dBm if the output termination is currently set to “high impedance”. The units are automatically converted to Vpp.

Soft Front Panel Operation

On the Amplitude panel as shown in [Figure 2-4](#), input the desired amplitude value and select the unit from the drop down list.

Remote Interface Operation

```
VOLTage:UNIT {VPP|VRMS|DBM}
```

Output Termination

This configuration applies to output amplitude and offset voltage only. The U2761A has a fixed series output impedance of 50 Ω to the device output connector. If the actual load impedance is different from the specified value, the amplitude and offset levels will be incorrect.

- The range of the output termination is 1 Ω to 10 k Ω , or Infinite. *The default value is 50 Ω*
- The output termination setting is stored in volatile memory and upon power-off or after a remote interface reset, the setting will return to a default value.
- If you specify a 50 Ω termination but are actually terminating into an open circuit, the actual output will be twice the value specified.

For example, if you set the offset to 100 mVDC (and specify a 50 Ω load) but are terminating the output into an open circuit, the actual offset will be 200 mVDC.

- If you change the output termination setting, the output amplitude and offset levels are automatically adjusted (no error will be generated).
For example, if you set the amplitude to 5 Vpp and then change the output termination from 50 Ω to “high impedance”, the amplitude value will double to 10 Vpp. If you change from “high impedance” to 50 Ω , the displayed amplitude value will drop to half.
- You cannot specify the output amplitude in dBm if the output termination is currently set to “high impedance”. The units are automatically converted to Vpp.

Soft Front Panel Operation

Click **Tools** and select **Waveform Gen** as shown in the following.

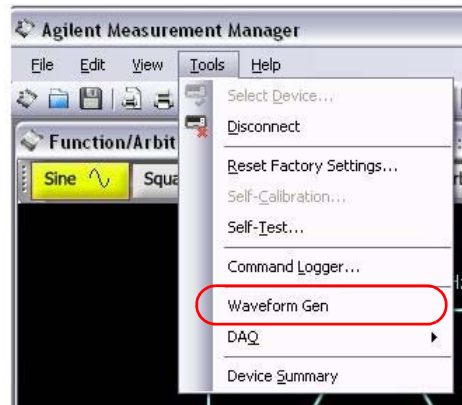



Figure 2-6 Panel view of the Tools menu

Then, select the **Output Setup** tab, input the desired load impedance value on the Impedance Load panel and select the unit from the drop down list, or select **High Z**  for high impedance load.

Remote Interface Operation

```
OUTPut:LOAD {<ohms>|INFinity}
```

Duty Cycle (Square Waves)

The duty cycle of a Square wave represents the amount of time per cycle that the Square wave is at a high level (assuming that the waveform is not inverted).

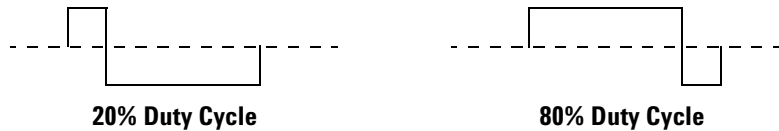

Figure 2-7 Square wave duty cycles

Refer to “[Pulse Waveform](#)” on page 45 for the information on the duty cycle for Pulse waveforms.

Duty Cycle

- 20% to 80% (frequency ≤ 10 MHz)
- 40% to 60% (frequency > 10 MHz)

The duty cycle is stored in volatile memory where the duty cycle is set to default 50% upon power-off or after a remote interface reset.

The duty cycle setting is stored when you change from Square wave to another function. Thus, when you return to the Square function, the previous duty cycle is used.

Limits Due to Frequency

If the Square wave function is selected and you change to a frequency that cannot produce the current duty cycle, the duty cycle is automatically adjusted to the maximum value for the new frequency.

For example, if you currently have the duty cycle set to 70% and then change the frequency to 12 MHz, the U2761A will automatically adjust the duty cycle to 60% (the upper limit for this frequency).

The duty cycle setting does not apply to a Square waveform used as the modulating waveform for AM, FM, or PM. A 50% duty cycle is always used for a modulating Square waveform. The duty cycle setting applies only to a Square waveform carrier.

Soft Front Panel Operation

After selecting **Square**  at the top panel as shown in [Figure 2-2](#), on the Duty Cycle panel below, input the desired duty cycle value.



Figure 2-8 Panel view of the duty cycle section

Remote Interface Operation

```
FUNCTION:SQUare:DCYcle <percent>
```

The APPLy command automatically sets the duty cycle to 50%.

Symmetry (Ramp Wave)

This configuration applies to Ramp wave only. Symmetry represents the amount of time per cycle that the Ramp wave is rising (assuming that the waveform is not inverted).

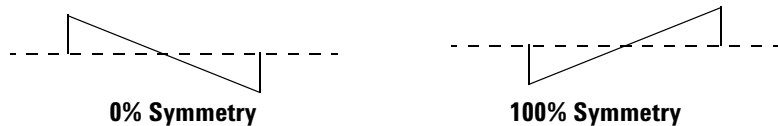

Figure 2-9 Ramp wave duty cycles

- The symmetry percentage is stored in volatile memory where the symmetry is set to default 100% upon power-off or after a remote interface reset.
- The symmetry setting is stored when you change from Ramp wave to another function. Thus, when you return to the Ramp function, the previous symmetry is used.
- If you select a Ramp waveform as the *modulating* waveform for AM, FM, or PM, the symmetry setting does not apply.

Soft Front Panel Operation

After selecting **Ramp**  at the top panel as shown in [Figure 2-2](#), on the Symmetry panel below, input the desired symmetry value.



Figure 2-10 Panel view of the symmetry section

Remote Interface Operation

```
FUNCTION:RAMP:SYMMetry <percent>
```

The `APPLY` command automatically sets the symmetry to 100%.

Output Control

You can disable or enable the soft front panel output control. By default, the output is disabled at power-on. When enabled, the **Output**  button is illuminated.

If an excessive external voltage is applied to the device output connector, the output will be disabled. To re-enable the output, remove the overload from the output connector and click **Output**  to enable the output.

Soft Front Panel Operation

Click **Output**  to enable or disable the output as shown in [Figure 2-11](#).



Figure 2-11 Panel view of the output section

Remote Interface Operation

```
OUTPut {0|OFF|1|ON}
```

The APPLy command overrides the current setting and automatically enables the output control.

Set Output Using SCPI Commands

The following SCPI commands show a sample procedure of generating output.

Example 1, To output a DC voltage

```
-> *CLS; *RST           //To reset the U2761A to default
                        //power-on state, this command
                        //can be ignored if this operation
                        //is not required.

-> FUNC DC              //Sets the output to DC.

-> VOLT:OFFS 1         //Sets the output DC offset voltage
                        //to 1 VDC.

-> OUTP:LOAD INF       //Changes the output termination
                        //to infinity.

-> OUTP ON             //Turns on output.
```

Example 2, To output a Sine wave

```

-> *CLS; *RST //To reset the U2761A to default
                power-on state, this command can
                be ignored if this operation is not
                required.

-> FUNC SIN //Sets the output to Sine wave.

-> VOLT 5 VPP //Sets the output amplitude to 5 Vpp.

-> FREQ 1000 //Sets the output frequency to 1 kHz.

-> VOLT:OFFS 0 //Sets the output offset to 0.

-> OUTP ON //Turns on output.

```

Example 3, To output a Square wave

```

-> *CLS; *RST //To reset the U2761A to
                default power-on state,
                this command can be
                ignored if this operation
                is not required.

-> APPL:SQU 2000,5 VPP,0 //Sets the output to Square
                            wave, frequency 2 kHz,
                            amplitude
                            5 Vpp, offset 0.

-> FUNC:SQU:DCYC 30 //Changes the duty cycle to
                        30%.

-> OUTP ON //Turns on output.

```

Example 4, To output a Ramp wave

```
-> *CLS; *RST //To reset the U2761A to default
                power-on state, this command
                can be ignored if this operation
                is not required.

-> FUNC RAMP //Sets the output to Ramp wave.

-> VOLT 5 VPP //Sets the output amplitude to
              5 Vpp.

-> FREQ 10000 //Sets the output frequency to
              10 kHz.

-> VOLT:OFFS 0 //Sets the output offset to 0.

-> FUNC:RAMP:SYMM 50 //Changes the symmetry to 50%.

-> OUTP ON //Turns on output.
```

Pulse Waveform

As shown below, a Pulse waveform consists of a period, a pulse width, a rising edge, and a falling edge.

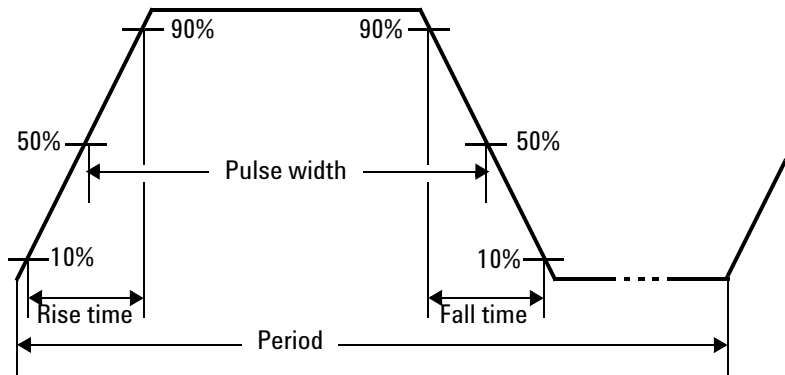



Figure 2-12 Pulse waveform

Pulse Period

The range of the pulse period is from 200 ns to 2000 s. *The default value is 1 ms.* The U2761A will adjust the pulse width as necessary to accommodate the specified period.

Soft Front Panel Operation

After selecting **Pulse**  at the top panel as shown in [Figure 2-2](#), on the Frequency panel as shown in [Figure 2-3](#), select **Period** , input the desired pulse period value, and then select the unit from the drop down list.

Remote Interface Operation

```
PULSe:PERiod <seconds>
```

Pulse Width

The pulse width represents the time from the 50% threshold of the pulse's rising edge to the 50% threshold of the next falling edge.

- The range of the pulse width is 40 ns to <2000 s (see restrictions below). *The default pulse width is 500 μs.*
- The minimum pulse width (W_{min}) is affected by the period.

$$W_{min} = 40 \text{ ns for period } \leq 10 \text{ s}$$

$$W_{min} = 200 \text{ ns for period } > 10 \text{ s, but } \leq 100 \text{ s}$$

$$W_{min} = 2 \text{ } \mu\text{s for period } > 100 \text{ s, but } \leq 1000 \text{ s}$$

$$W_{min} = 20 \text{ } \mu\text{s for period } > 1000 \text{ s}$$

- The specified pulse width must also be less than the difference between the period and the minimum pulse width as shown in the equation below. The U2761A will adjust the pulse width as necessary to accommodate the specified period.

$$\text{Pulse Width} \leq \text{Period} - W_{min}$$

Soft Front Panel Operation

After selecting **Pulse**  at the top panel as shown in [Figure 2-2](#), on the Width panel below, input the desired pulse width value and select the unit from the drop down list.



Figure 2-13 Panel view of the pulse width section

Remote Interface Operation

FUNCTION:PULSE:WIDTH <seconds>

Pulse Duty Cycle

The pulse duty cycle is defined as:

$$\text{Duty Cycle} = 100 \times \text{Pulse Width} / \text{Period}$$

where the pulse width represents the time from the 50% threshold of the rising edge of the pulse to the 50% threshold of the next falling edge.

- Pulse duty cycle: >0% to <100% (see restrictions below).
The default is 50%.
- The specified pulse duty cycle must conform to the following restrictions determined by the minimum pulse width (Wmin). The U2761A will adjust the pulse duty cycle as needed to accommodate the specified period.

$$\text{Duty Cycle} \geq 100 \times W_{\min} / \text{Period}$$

and

$$\text{Duty Cycle} \leq 100 \times (1 - W_{\min} / \text{Period})$$

where:



$$W_{\min} = 40 \text{ ns for period} \leq 10 \text{ s.}$$

$$W_{\min} = 200 \text{ ns for period} > 10 \text{ s, but} \leq 100 \text{ s.}$$

$$W_{\min} = 2 \text{ } \mu\text{s for period} > 100 \text{ s, but} \leq 1000 \text{ s.}$$

$$W_{\min} = 20 \text{ } \mu\text{s for period} > 1000 \text{ s.}$$

Soft Front Panel Operation

After selecting **Pulse**  at the top panel as shown in [Figure 2-2](#), select **Duty Cycle**  as shown in [Figure 2-13](#) and input the desired pulse duty cycle value on the Duty Cycle panel.

Remote Interface Operation

```
FUNCTION:PULSe:DCYcle <percent>
```

Generate Pulse Waveform Using SCPI Commands

Example 1

```
-> *CLS; *RST //To reset the U2761A to default
                power-on state, this command
                can be ignored if this operation
                is not required.

-> FUNC PULS //Sets the output to Pulse wave.
-> VOLT 5 VPP //Sets the output amplitude to
              5 Vpp.
-> VOLT:OFFS 0 //Sets the output offset to 0.
-> PULS:PER 1 //Sets the pulse period to 1 s.
-> FUNC:PULS:DCYC 50 //Set the pulse duty cycle to 50%.
-> OUTP ON //Turns on output.
```

Amplitude Modulation (AM)

A modulated waveform consists of a carrier waveform and a modulating waveform. An example of the AM waveform is shown in Figure 2-14. In AM, the amplitude of the carrier is varied by the instantaneous voltage of the modulating waveform. The amount of amplitude modulation is called the modulation depth which refers to the portion of the amplitude range that will be used by the modulation.

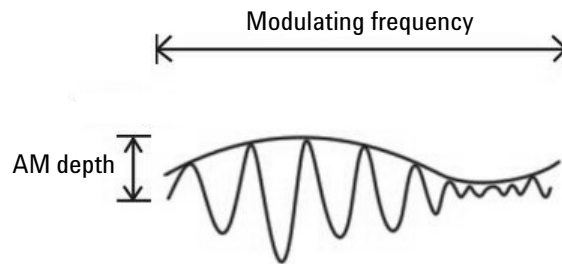

Figure 2-14 AM waveform

To Select AM

The U2761A allows only one modulation mode at a time. The U2761A does not allow modulation when sweep is enabled.

Soft Front Panel Operation



Click **Mod**  and then select **AM**  as shown in [Figure 2-15](#). To output the AM waveform, configure the settings for the carrier frequency, modulating frequency, depth, output amplitude, offset voltage, and the desired waveform.



Figure 2-15 Panel view of AM

Remote Interface Operation

AM:STATE {0|OFF|1|ON}

Carrier Waveform

The AM carrier waveform consists of Sine, Square, Ramp, Triangle, or Arbitrary waveform. *The default waveform is Sine wave. You cannot use Pulse or DC as the carrier waveform.*

Soft Front Panel Operation



For Arbitrary waveform, select **Arb**  at the top panel as shown in [Figure 2-2](#) and then select the desired waveform from the drop down list  as shown in [Figure 2-16](#).



Figure 2-16 Panel view of the Arbitrary waveform

Remote Interface Operation

```
FUNCTION {SINusoid|SQUare|RAMP|USER}
```

You can also use the APPLy command to select the function, frequency, amplitude, and offset.

Carrier Frequency

The maximum carrier frequency depends on the selected function as shown below. *The default frequency is 1 kHz for all functions.*

Table 2-3 Carrier frequency for AM

Function	Minimum frequency	Maximum frequency
Sine	1 μ Hz	20 MHz
Square	1 μ Hz	20 MHz
Ramp, Triangle	1 μ Hz	200 kHz
Arbitrary	1 μ Hz	200 kHz

Soft Front Panel Operation

On the Frequency panel as shown in [Figure 2-3](#), input the desired frequency value and select the unit from the drop down list.

Remote Interface Operation

```
FREQUENCY <frequency>
```

You can also use the APPLY command to select the function, frequency, amplitude, and offset.

Modulating Waveform

The modulating waveform consists of Sine, Square, Ramp, Negative Ramp (N Ramp), Triangle, or Arbitrary waveform. *The default modulating waveform is Sine wave.*

- Square has 50% duty cycle
- Ramp has 100% symmetry
- Triangle has 50% symmetry
- Negative Ramp has 0% symmetry



Soft Front Panel Operation

Select the desired modulating waveform from the drop down list as shown in [Figure 2-15](#).

Remote Interface Operation

```
AM:INTernal:FUNCTION  
{SINusoid|SQUare|RAMP|NRAMP|TRIangle|USER}
```

Modulating Waveform Frequency

The range of the modulating waveform frequency is 2 mHz to 20 kHz. *The default modulating waveform frequency is 100 Hz.*

Soft Front Panel Operation

On the Mod Frequency panel as shown in [Figure 2-15](#), input the desired modulating frequency value and select the unit from the drop down list.

Remote Interface Operation

```
AM:INTernal:FREQuency <frequency>
```

Modulation Depth

The modulation depth is expressed in percentage and represents the extent of the amplitude variation. At 0% depth, the output amplitude is half of the selected value. At 100% depth, the output amplitude equals the selected value.

The range of the modulation depth is 0% to 100%. *The default modulation depth is 100%.*

NOTE

At 100% depth, the maximum output of the U2761A will not exceed ± 2.5 V peak (into a 50 Ω load).

Soft Front Panel Operation

On the Depth panel as shown in [Figure 2-15](#), select the desired modulating depth value from the drop down list.

Remote Interface Operation

```
AM:DEPTh <depth in percent>
```

Generate AM Using SCPI Commands

Example 1

```
-> *CLS; *RST //To reset the U2761A to default
                power-on state, this command
                can be ignored if this operation
                is not required.

-> AM:STAT ON //Enables AM.

-> FUNC SQU //Sets the carrier waveform to
            Square wave.

-> FREQ 2000 //Sets the carrier frequency to
            2 kHz.

-> VOLT 5 VPP //Sets the output amplitude to
            5 Vpp.

-> VOLT:OFFS 0 //Sets the output offset to 0.

-> AM:INT:FUNC SIN //Changes the modulating
                  waveform shape to Sine wave.

-> AM:INT:FREQ 500 //Changes the modulating
                  frequency to 500 Hz.

-> AM:DEPT 50 //Changes the modulation depth
              to 50%.

-> OUTP ON //Turns on output.
```

Frequency Modulation (FM)

A modulated waveform consists of a carrier waveform and a modulating waveform. Below shows an example of the FM waveform. In FM, the frequency of the carrier is varied by the instantaneous voltage of the modulating waveform. The variation in frequency of the modulated waveform from the carrier frequency is called the frequency deviation.

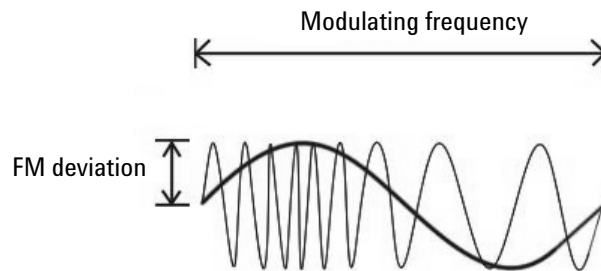

Figure 2-17 FM waveform

To Select FM

The U2761A allows only one modulation mode to be enabled at a time. The U2761A does not allow FM to be enabled at the same time that sweep is enabled.

Soft Front Panel Operation



Click **Mod**  and then select **FM**  as shown in [Figure 2-18](#). To output the FM waveform, configure the settings for the carrier frequency, output amplitude, offset voltage, modulating frequency, deviation, and the desired waveform.



Figure 2-18 Panel view of FM



Remote Interface Operation

```
FM:STATe {0|OFF|1|ON}
```

Carrier Waveform

The FM carrier waveform consists of Sine, Square, Ramp, Triangle, or Arbitrary waveform. *The default waveform is Sine wave.* You *cannot* use Pulse or DC as the carrier waveform.

Soft Front Panel Operation

For Arbitrary waveforms, select **Arb**  at the top panel as shown in [Figure 2-2](#) and select the desired waveform from the drop down list  as shown in [Figure 2-16](#).

Remote Interface Operation

FUNCTION {SINusoid|SQUare|RAMP|USER}

You can also use the APPLY command to select the function, frequency, amplitude, and offset.

Carrier Frequency

The maximum carrier frequency depends on the selected function as shown below. *The default is 1 kHz for all functions.*

Table 2-4 Carrier frequency for FM

Function	Minimum frequency	Maximum frequency
Sine	1 μ Hz	20 MHz
Square	1 μ Hz	20 MHz
Ramp, Triangle	1 μ Hz	200 kHz
Arbitrary	1 μ Hz	200 kHz

The carrier frequency must always be greater than or equal to the frequency deviation plus 1 μ Hz. If you attempt to set the deviation to a value plus 1 μ Hz greater than the carrier frequency (with FM enabled), the U2761A will automatically adjust the deviation to the maximum value allowed with the present carrier frequency.

The sum of the carrier frequency and deviation must be less than or equal to the maximum frequency for the selected function (20 MHz for Sine and Square, 200 kHz for Ramp and Arbitrary waveforms). If you attempt to set the deviation to a value that is not valid, the U2761A will automatically adjust it to the maximum value allowed with the present carrier frequency.

Soft Front Panel Operation

On the Frequency panel as shown in [Figure 2-3](#), input the desired frequency value and select the unit from the drop down list.

Remote Interface Operation

```
FREquency <frequency>
```

You can also use the APPLy command to select the function, frequency, amplitude, and offset.

Modulating Waveform

The modulating waveform consists of Sine, Square, Ramp, Negative Ramp (N Ramp), Triangle, Noise, or Arbitrary waveform. *The default modulating waveform is Sine wave.*

- Square has 50% duty cycle
- Ramp has 100% symmetry
- Triangle has 50% symmetry
- Negative Ramp has 0% symmetry



Soft Front Panel Operation

Select the desired modulating waveform from the drop down list as shown in [Figure 2-18](#).

Remote Interface Operation

```
FM:INTernal:FUNCTION  
{SINusoid|SQUare|RAMP|NRAMP|TRIangle|USER}
```

Modulating Waveform Frequency

The range of the modulating waveform frequency is 2 mHz to 20 kHz. *The default modulating waveform frequency is 100 Hz.*

Soft Front Panel Operation

On the Mod Frequency panel as shown in [Figure 2-18](#), input the desired modulating frequency value and select the unit from the drop down list.

Remote Interface Operation

```
FM:INTernal:FREQuency <frequency>
```

Frequency Deviation

The frequency deviation setting represents the peak variation in frequency of the modulated waveform from the carrier frequency.

The range of the frequency deviation is 1 Hz to 500 kHz (limited to 100 kHz minus 1 μ Hz for Ramp and Arbitrary waveforms). *The default frequency deviation is 100 Hz.*

The carrier frequency must always be greater than or equal to the frequency deviation plus 1 μ Hz. If you attempt to set the deviation to a value plus 1 μ Hz greater than the carrier frequency (with FM enabled), the U2761A will automatically adjust the deviation to the maximum value allowed with the present carrier frequency.

The sum of the carrier frequency and deviation must be less than or equal to the maximum frequency for the selected function (20 MHz for Sine and Square, and 200 kHz for Ramp and Arbitrary waveforms). If you attempt to set the deviation to a value that is not valid, the U2761A will automatically adjust it to the maximum value allowed with the present carrier frequency.

Soft Front Panel Operation

On the Deviation panel as shown in [Figure 2-18](#), input the desired frequency deviation value and select the unit from the drop down list.

Remote Interface Operation

```
FM:DEVIation <peak deviation in Hz>
```

Generate FM Using SCPI Commands

Example 1

```
-> *CLS; *RST //To reset the U2761A to default
                //power-on state, this command
                //can be ignored if this operation
                //is not required.

-> FM:STAT ON //Enables FM.

-> FUNC SIN //Sets the carrier waveform to
            //Sine wave.

-> FREQ 1000 //Sets the carrier frequency to
            //1 kHz.

-> VOLT 5 VPP //Sets the output amplitude to
            //5 Vpp.

-> VOLT:OFFS 0 //Sets the output offset to 0.

-> FM:INT:FUNC SIN //Changes the modulating
                //waveform shape to Sine wave.

-> FM:INT:FREQ 500 //Changes the modulating
                //frequency to 500 Hz.

-> FM:DEV 100 //Changes the frequency
                //deviation to 100 Hz.

-> OUTP ON //Turns on output.
```

Phase Modulation (PM)

A modulated waveform consists of a carrier waveform and a modulating waveform. The following figure shows an example of a PM waveform. PM is very similar to FM, but in PM, the *phase* of the modulated waveform is varied by the instantaneous voltage of the modulating waveform. The variation in phase of the modulated waveform from the carrier waveform is called the phase deviation.

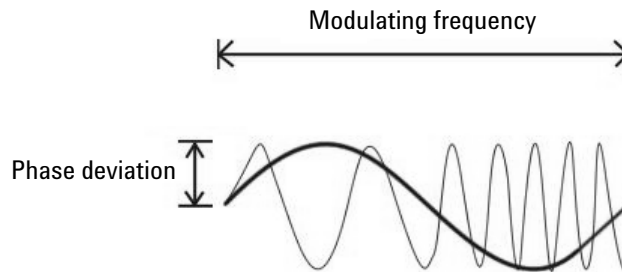



Figure 2-19 PM waveform

To Select PM

The U2761A allows only one modulation mode to be enabled at a time. The U2761A does not allow PM to be enabled at the same time that sweep is enabled.

Soft Front Panel Operation

Click **Mod**  and then select **PM**  as shown in [Figure 2-20](#). To output the PM waveform, configure the settings for the carrier frequency, output amplitude, offset voltage, modulating frequency, phase deviation, and the desired waveform.

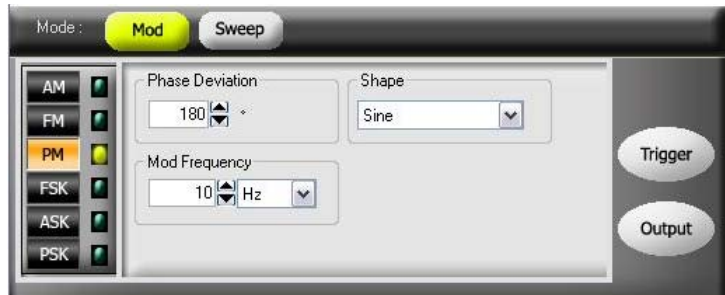

Figure 2-20 Panel view of PM

Remote Interface Operation

PM:STATE {0|OFF|1|ON}

Carrier Waveform

The PM carrier waveform consists of Sine, Square, Ramp, Triangle, or Arbitrary waveform. *The default waveform is Sine wave. You cannot use Pulse or DC as the carrier waveform.*

Soft Front Panel Operation

For Arbitrary waveforms, click **Arb**  at the top panel as shown in [Figure 2-2](#) and select the desired waveform from the drop down list  as shown in [Figure 2-16](#).

Remote Interface Operation

```
FUNCTION {SINusoid|SQUare|RAMP|USER}
```

You can also use the APPLY command to select the function, frequency, amplitude, and offset.

Carrier Frequency

The maximum carrier frequency depends on the function selected as shown below. *The default carrier frequency is 1 kHz for all functions.*

Table 2-5 Carrier frequency for PM

Function	Minimum frequency	Maximum frequency
Sine	1 μ Hz	20 MHz
Square	1 μ Hz	20 MHz
Ramp, Triangle	1 μ Hz	200 kHz
Arbitrary	1 μ Hz	200 kHz

Soft Front Panel Operation

On the Frequency panel as shown in [Figure 2-3](#), input the desired frequency value and select the unit from the drop down list.

Remote Interface Operation

```
FREQuency <frequency>
```

You can also use the APPLY command to select the function, frequency, amplitude, and offset.

Modulating Waveform

The modulating waveform consists of Sine, Square, Ramp, Negative Ramp (N Ramp), Triangle, or Arbitrary waveform. *The default waveform is Sine wave.*

- Square has 50% duty cycle
- Ramp has 100% symmetry
- Triangle has 50% symmetry
- Negative Ramp has 0% symmetry



Soft Front Panel Operation

Select the desired modulating waveform from the drop down list as shown in [Figure 2-20](#).

Remote Interface Operation

```
PM:INTernal:FUNCTION  
{SINusoid|SQUare|RAMP|NRAMP|TRIangle|USER}
```

Modulating Waveform Frequency

The range of the modulating waveform frequency is 2 mHz to 20 kHz. *The default modulating waveform frequency is 10 Hz.*

Soft Front Panel Operation

On the Mod Frequency panel as shown in [Figure 2-20](#), input the desired modulating frequency value and select the unit from the drop down list.

Remote Interface Operation

```
PM:INTernal:FREQuency <frequency>
```

Phase Deviation

The phase deviation setting represents the peak variation in phase of the modulated waveform from the carrier waveform. The phase deviation setting can be set from 0 to 360°. *The default phase deviation setting is 180°.*

Soft Front Panel Operation

On the Phase Deviation panel as shown in [Figure 2-20](#), input the desired phase deviation value.

Remote Interface Operation

```
PM:DEVIation <deviation in degrees>
```

Generate PM Using SCPI Commands

Example 1

```
-> *CLS; *RST           //To reset the U2761A to default
                        //power-on state, this command
                        //can be ignored if this operation
                        //is not required.

-> PM:STAT ON           //Enables PM.
-> FUNC SIN             //Sets the carrier waveform to
                        //Sine wave.
-> FREQ 1000            //Sets the carrier frequency to
                        //1 kHz.
-> VOLT 5 VPP           //Sets the output amplitude to
                        //5 Vpp.
-> VOLT:OFFS 0          //Sets the output offset to 0.
-> PM:INT:FUNC SIN      //Changes the modulating
                        //waveform shape to Sine wave.
-> PM:INT:FREQ 500      //Changes the modulating
                        //frequency to 500 Hz.
-> PM:DEV 180           //Changes the phase deviation to
                        //180°.
-> OUTP ON              //Turns on output.
```

Frequency-Shift Keying (FSK) Modulation

FSK is similar to FM except that the frequency alternates between two preset values. You can configure the U2761A to “shift” its output frequency between two preset values using FSK modulation. An example of the FSK modulation waveform is shown below. The rate at which the output shifts between the two frequencies (called the “carrier frequency” and the “hop frequency”) is determined by the internal rate generator.

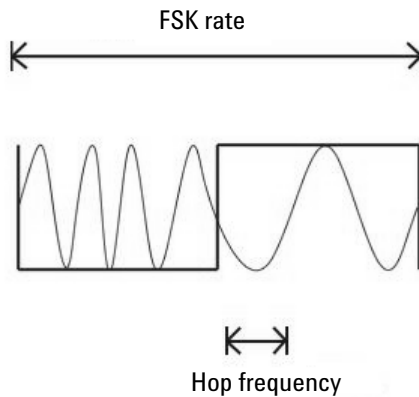

Figure 2-21 FSK modulation waveform

To Select FSK Modulation

The U2761A allows only one modulation mode to be enabled at a time. The U2761A does not allow FSK to be enabled at the same time that sweep is enabled.

Soft Front Panel Operation



Click **Mod**  and select **FSK**  as shown in [Figure 2-22](#). To output the FSK waveform, configure the settings for the carrier frequency, output amplitude, offset voltage, “hop frequency”, and FSK rate.



Figure 2-22 Panel view of FSK



Remote Interface Operation

```
FSKey:STATE {0|OFF|1|ON}
```

Carrier Waveform

The FSK carrier waveform consists of Sine, Square, Ramp, Triangle, or Arbitrary waveform. *The default carrier waveform is Sine wave.* You *cannot* use Pulse or DC as the carrier waveform.

Soft Front Panel Operation

For Arbitrary waveforms, click **Arb**  at the top panel as shown in [Figure 2-2](#) and select the desired waveform from the drop down list  as shown in [Figure 2-16](#).

Remote Interface Operation

```
FUNCTION {SINusoid|SQUare|RAMP|USER}
```

You can also use the APPLY command to select the function, frequency, amplitude, and offset.

FSK Carrier Frequency

The maximum carrier frequency depends on the function selected as shown below. *The default carrier frequency is 1 kHz for all functions.*

Table 2-6 Carrier frequency for FSK

Function	Minimum frequency	Maximum frequency
Sine	1 μ Hz	20 MHz
Square	1 μ Hz	20 MHz
Ramp, Triangle	1 μ Hz	200 kHz
Arbitrary	1 μ Hz	200 kHz

Soft Front Panel Operation

On the Frequency panel as shown in [Figure 2-3](#), input the desired frequency value and select the unit from the drop down list.

Remote Interface Operation

```
FREQuency <frequency>
```

You can also use the APPLY command to select the function, frequency, amplitude, and offset.

FSK “Hop” Frequency

The maximum alternate (or “hop”) frequency depends on the function selected as shown below. *The default “hop” frequency is 100 Hz for all functions.*

Table 2-7 “Hop” frequency

Function	Minimum frequency	Maximum frequency
Sine	1 μ Hz	20 MHz
Square	1 μ Hz	20 MHz
Ramp, Triangle	1 μ Hz	200 kHz
Arbitrary	1 μ Hz	200 kHz

Only Square wave with a 50% duty cycle is available for the Internal FSK modulating waveform.

Soft Front Panel Operation

On the Hop Frequency panel as shown in [Figure 2-22](#), input the desired hop frequency value and select the unit from the drop down list.

Remote Interface Operation

```
FSKey:FREQuency <frequency>
```

FSK Rate

The FSK rate is the rate at which the output frequency “shifts” between the carrier frequency and the hop frequency.

- The range of the FSK rate is 2 mHz to 100 kHz. *The default FSK rate value is 10 Hz.*

Soft Front Panel Operation

On the FSK Rate panel as shown in [Figure 2-22](#), input the desired FSK rate value and select the unit from the drop down list.

Remote Interface Operation

```
FSKey:INTernal:RATE <rate in Hz>
```

Generate FSK Modulation Using SCPI Commands

Example 1

```
-> *CLS; *RST //To reset the U2761A to default
                power-on state, this command
                can be ignored if this operation
                is not required.

-> FSK:STAT ON //Enables FSK modulation.

-> FUNC SIN //Sets the carrier waveform to
            Sine wave.

-> FREQ 1000 //Sets the carrier frequency to
            1 kHz.

-> VOLT 5 VPP //Sets the output amplitude to
            5 Vpp.

-> VOLT:OFFS 0 //Sets the output offset to 0.

-> FSK:FREQ 100 //Sets the "hop" frequency to
            100 Hz.

-> FSK:INT:RATE 10 //Sets the FSK rate to 10 Hz.

-> OUTP ON //Turns on output.
```

Phase-Shift Keying (PSK) Modulation

Phase-shift keying (PSK) is a form of digital modulation in which the phase of the carrier signal is discretely varied. You can configure the U2761A to “shift” its output phase between two preset phases using PSK. The rate at which the output shifts between the two phases is determined by the internal rate generator on the signal level. The following figure shows an example of the PSK modulation waveform.

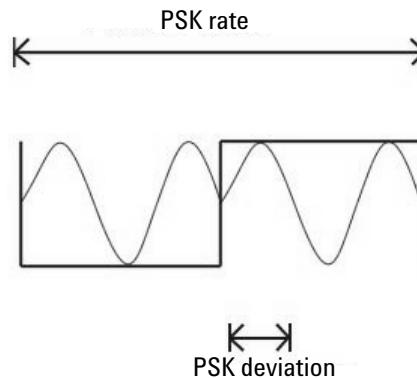

Figure 2-23 PSK modulation waveform

To Select PSK Modulation

The U2761A allows only one modulation mode to be enabled at a time. The U2761A does not allow PSK to be enabled at the same time that sweep is enabled.

Soft Front Panel Operation



Click **Mod**  and then select **PSK**  as shown in [Figure 2-24](#). To output the PSK waveform, configure the settings for the carrier frequency, output amplitude, offset voltage, deviation, and PSK rate.



Figure 2-24 Panel view of PSK



Remote Interface Operation

PSKey:STATE {0|OFF|1|ON}

Carrier Waveform

The PSK carrier waveform consists of Sine, Square, Ramp, Triangle, or Arbitrary waveform. *The default waveform is Sine wave.* You cannot use Pulse or DC as the carrier waveform.

Soft Front Panel Operation

For Arbitrary waveforms, select **Arb**  at the top panel as shown in [Figure 2-2](#) and select the desired waveform from the drop down list  as shown in [Figure 2-16](#).

Remote Interface Operation

```
FUNCTION {SINusoid|SQUare|RAMP|USER}
```

You can also use the APPLY command to select the function, frequency, amplitude, and offset.

PSK Carrier Frequency

The maximum carrier frequency depends on the function selected as shown below. *The default is 1 kHz for all functions.*

Table 2-8 Carrier frequency for PSK

Function	Minimum frequency	Maximum frequency
Sine	1 μ Hz	20 MHz
Square	1 μ Hz	20 MHz
Ramp, Triangle	1 μ Hz	200 kHz
Arbitrary	1 μ Hz	200 kHz

Only Square wave with a 50% duty cycle is available for the Internal PSK modulating waveform.

Soft Front Panel Operation

On the Frequency panel shown in [Figure 2-3](#), input the desired frequency value and select the unit from the drop down list.

Remote Interface Operation

```
FREQuency <frequency>
```

You can also use the APPLY command to select the function, frequency, amplitude, and offset.

PSK Rate

The PSK rate is the rate at which the output phase “shifts” between two preset phases. The range of the PSK rate is 2 mHz to 100 kHz. *The default PSK rate value is 10 Hz.*

Soft Front Panel Operation

On the PSK Rate panel as shown in [Figure 2-24](#), input the desired PSK rate value and select the unit from the drop down list.

Remote Interface Operation

```
PSKey:INTernal:RATE <rate in Hz>
```

PSK Deviation

The deviation setting represents the phase variation of the shifted waveform from the carrier waveform. The deviation can be set from 0 to 360°. *The default deviation setting is 180°.*

Soft Front Panel Operation

On the Deviation panel as shown in [Figure 2-24](#), input the desired deviation value.

Remote Interface Operation

```
PSKey:DEVIation <deviation in degrees>
```

Generate PSK Modulation Using SCPI Commands

Example 1

```
-> *CLS; *RST //To reset the U2761A to
                //default power-on state, this
                //command can be ignored if
                //this operation is not
                //required.

-> PSK:STAT ON //Enables PSK modulation.

-> FUNC SIN //Sets the carrier waveform to
            //Sine wave.

-> FREQ 1000 //Sets the carrier frequency to
            //1 kHz.

-> VOLT 5 VPP //Sets the output amplitude to
            //5 Vpp.

-> VOLT:OFFS 0 //Sets the output offset to 0.

-> PSK:INT:RATE 10 //Sets the PSK rate to
                //10 Hz.

-> PSK:DEV 180 //Sets the PSK deviation to
                //180°.

-> OUTP ON //Turns on output.
```

Amplitude-Shift Keying (ASK) Modulation

ASK is a form of digital modulation in which the modulating signal apply variations in the amplitude of a carrier signal. The amplitude of the carrier signal varies simultaneously with the modulating signal while phase and frequency remain constant. In other words, the carrier signal can be assumed as an on and off switch. You can configure the U2761A to “shift” its output amplitude between two preset amplitudes using ASK. The rate at which the output shifts between the two amplitudes is determined by the internal rate generator. An example of the ASK modulation waveform is shown in the following.

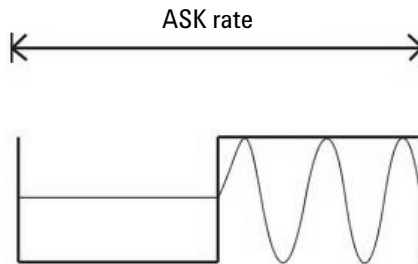

Figure 2-25 ASK modulation waveform

To Select ASK Modulation

The U2761A allows only one modulation mode to be enabled at a time. The U2761A does not allow ASK to be enabled at the same time that sweep is enabled.

Soft Front Panel Operation



Click **Mod**  and then select **ASK**  as shown in [Figure 2-26](#). To output the ASK waveform, configure the settings for the carrier frequency, output amplitude, offset voltage, and ASK rate.



Figure 2-26 Panel view of ASK



Remote Interface Operation

```
ASKey:STATE {0 | OFF | 1 | ON}
```

Carrier Waveform

The ASK carrier waveform consists of Sine, Square, Ramp, Triangle, or Arbitrary waveform. *The default waveform is Sine wave. You cannot use Pulse or DC as the carrier waveform.*

Soft Front Panel Operation

For Arbitrary waveforms, select **Arb**  at the top panel as shown in [Figure 2-2](#) and select the desired waveform from the drop down list  as shown in [Figure 2-16](#).

Remote Interface Operation

```
FUNCTION {SINusoid|SQUare|RAMP|USER}
```

You can also use the APPLY command to select the function, frequency, amplitude, and offset.

Carrier Frequency

The maximum carrier frequency depends on the function selected as shown below. *The default is 1 kHz for all functions.*

Table 2-9 Carrier frequency for ASK

Function	Minimum frequency	Maximum frequency
Sine	1 μ Hz	20 MHz
Square	1 μ Hz	20 MHz
Ramp, Triangle	1 μ Hz	200 kHz
Arbitrary	1 μ Hz	200 kHz

Only Square wave with a 50% duty cycle is available for the Internal ASK modulating waveform.

Soft Front Panel Operation

On the Frequency panel as shown in [Figure 2-3](#), input the desired frequency value and select the unit from the drop down list.

Remote Interface Operation

```
FREQuency <frequency>
```

You can also use the APPLY command to select the function, frequency, amplitude, and offset.

ASK Rate

The ASK rate is the rate at which the output amplitude “shifts” between two preset amplitudes. The range of the ASK rate is 2 mHz to 100 kHz. *The default ASK rate value is 10 Hz.*

Soft Front Panel Operation

On the ASK Rate panel as shown in [Figure 2-26](#), input the desired ASK rate value and select the unit from the drop down list.

Remote Interface Operation

```
ASKey:INTernal:RATE <rate in Hz>
```

Generate ASK Modulation Using SCPI Commands

Example 1

```
-> *CLS; *RST //To reset the U2761A to
                default power-on state, this
                command can be ignored if
                this operation is not
                required.

-> ASK:STAT ON //Enables ASK modulation.
-> FUNC SIN //Sets the carrier waveform to
             Sine wave.
-> FREQ 1000 //Sets the carrier frequency to
             1 kHz.
-> VOLT 5 VPP //Sets the output amplitude to
             5 Vpp.
-> VOLT:OFFS 0 //Sets the output offset to 0.
-> ASK:INT:RATE 10 //Sets the ASK rate to
                  10 Hz.
-> OUTP ON //Turns on output.
```

Frequency Sweep

In the frequency sweep mode, the U2761A “steps” from the start frequency to the stop frequency at a sweep rate which you specify. You can sweep up or down in frequency, and with either linear or logarithmic spacing. You can also configure the U2761A to output a single sweep (one pass from start frequency to stop frequency) by applying an External or Manual (software) trigger. The U2761A can produce a frequency sweep for Sine, Square, Ramp, Triangle, or Arbitrary’s waveform (Pulse and DC are not allowed). The figure below shows an example of the frequency sweep.

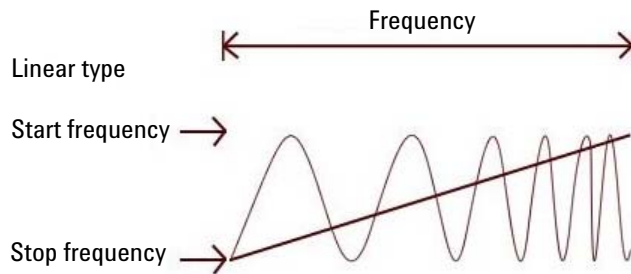

Figure 2-27 Frequency sweep

To Select Sweep

The U2761A does not allow the sweep mode to be enabled at the same time that any modulation mode is enabled.

Soft Front Panel Operation

Click **Sweep**  as shown in [Figure 2-28](#). To output sweep, configure the settings for frequencies, output amplitude, offset, sweep type and time, and trigger setup.



Figure 2-28 Panel view of sweep

Remote Interface Operation

SWEep:STATe {0 | OFF | 1 | ON}

Start Frequency and Stop Frequency

The start frequency and stop frequency sets the upper and lower frequency bounds for the sweep. The U2761A begins at the start frequency, sweeps to the stop frequency, and then resets back to the start frequency.

- The range of the start and stop frequencies is 1 μ Hz to 20 MHz (limited to 200 kHz for Ramp and Arbitrary waveforms). The sweep is phase-continuous over the full frequency range. *The default start frequency is 100 Hz. The default stop frequency is 1 kHz.*
- To sweep **up** in frequency, set the start frequency < stop frequency. To sweep **down** in frequency, set the start frequency > stop frequency.

Soft Front Panel Operation

On the Start Frequency and Stop Frequency panels as shown in [Figure 2-28](#), input the desired *start frequency* and *stop frequency* values and select the respective units from the drop down lists.

Remote Interface Operation

```
FREQuency:START <frequency>
```

```
FREQuency:STOP <frequency>
```

Sweep Mode

You can sweep with either linear or logarithmic spacing. For a *linear* sweep, the U2761A varies the output frequency in a linear fashion during the sweep. For a *logarithmic* sweep, the U2761A varies the output frequency in a logarithmic fashion.

The sweep mode consists of Linear or Logarithmic. *The default sweep mode is Linear.*

Soft Front Panel Operation

On the Sweep Type panel as shown in [Figure 2-28](#), select the Linear Linear or Log Log mode.

Remote Interface Operation

```
SWEep:SPACing {LINear|LOGarithmic}
```

Sweep Time

The sweep time specifies the number of seconds required to sweep from the start frequency to the stop frequency. The number of discrete frequency points in the sweep is automatically calculated by the U2761A and is based on the sweep time you have selected. The range of the sweep time is 1 ms to 500 s. *The default sweep time is 1 s.*

Soft Front Panel Operation

On the Sweep Time panel as shown in [Figure 2-28](#), input the desired sweep time and select the unit from the drop down list.

Remote Interface Operation

SWEep:TIME <seconds>

Sweep Trigger Source

In the sweep mode, the U2761A outputs a single sweep when a trigger signal is received. After one sweep from the start frequency to the stop frequency, the U2761A will continuously output the preset waveform at the start frequency while waiting for the next trigger.



- The sweep trigger source consists of Internal (immediate), External, or Manual (software). *The default trigger source is Internal.*
- When the *Internal* source is selected, the U2761A outputs a continuous sweep at a rate determined by the specified sweep time.
- When the *External* source is selected, the U2761A accepts a hardware trigger applied to the device Trig In connector. The U2761A initiates one sweep each time Trig In receives a TTL pulse with the specified polarity.
- When the *Manual* source is selected, the U2761A outputs one sweep each time the soft front panel **Trigger**  is clicked.

Soft Front Panel Operation

On the Trigger Setup panel as shown in [Figure 2-28](#), select the desired sweep trigger source from the drop down list



at the Source panel.

To specify whether the U2761A is triggered on the rising or falling edge of the signal from the Trig In connector, select **Positive**  Positive for rising edge triggering and **Negative**  Negative for falling edge triggering.

Remote Interface Operation

```
TRIGger:SOURce {IMMediate|EXternal|BUS}
```

Use the following command to specify whether the U2761A is triggered on the rising or falling edge of the signal from the Trig In connector.

```
TRIGger:SLOPe {POSitive|NEGative}
```

Set Frequency Sweep Using SCPI Commands

Example 1

```
-> *CLS; *RST           //To reset the U2761A to default
                        //power-on state, this command
                        //can be ignored if this operation
                        //is not required.

-> FUNC SIN             //Sets the carrier waveform to
                        //Sine wave.

-> VOLT 5 VPP           //Sets the output amplitude to
                        //5 Vpp.

-> VOLT:OFFS 0          //Sets the output offset to 0.

-> SWE:STAT ON          //Enables frequency sweep.

-> FREQ:STAR 500        //Changes the start frequency to
                        //500 Hz.

-> FREQ:STOP 10000     //Changes the stop frequency to
                        //10 kHz.

-> SWE:SPAC LIN         //Changes the sweep mode to
                        //Linear.

-> SWE:TIME 2           //Changes the sweep time to 2 s.

-> TRIG:SOUR EXT        //Changes the sweep trigger
                        //source to External.

-> TRIG:SLOP POS       //Changes the U2761A to be
                        //triggered on the rising edge.

-> OUTP ON              //Turns on output.
```

Triggering

Applies to sweep only. You can issue triggers for sweeps using *Internal* (immediate) triggering, *External* triggering, or *Manual* (software) triggering.

- *Internal* triggering is enabled when you turn on the U2761A. In this mode, the U2761A outputs continuously when the sweep mode is selected.
- *External* triggering uses the device Trig In connector to control the sweep. The U2761A initiates one sweep each time Trig In receives a TTL pulse. You can select whether the U2761A is triggered on the rising or falling edge of the External trigger signal.
- *Manual* triggering initiates one sweep each time you click **Trigger**  on the soft front panel.

Trigger Source Choices

You must specify the source from which the U2761A accepts a trigger.

- The sweep trigger source consists of Internal, External, or Manual. *The default trigger source is Internal.*
- The U2761A accepts a Manual trigger, a hardware trigger from the device Trig In connector, or continuously output sweeps using an Internal trigger. At power-on, Internal trigger is selected.
- The trigger source setting is stored in volatile memory where the source is set to Internal (immediate) trigger upon power-off or after a remote interface reset.

Soft Front Panel Operation

On the Trigger Setup panel as shown in [Figure 2-28](#), select the desired trigger source from the drop down list

 at the Source panel.

Remote Interface Operation

```
TRIGger:SOURce {IMMediate|EXTernal|BUS}
```

Internal Triggering

In the Internal trigger mode, the U2761A continuously performs frequency sweep (as specified by the sweep time). This is the default trigger source for both soft front panel and remote interface use.



Soft Front Panel Operation

On the Trigger Setup panel as shown in [Figure 2-28](#), select **Internal** from the drop down list at the Source panel.

Remote Interface Operation

```
TRIGger:SOURce IMMediate
```

Manual Triggering

In the Manual (software) triggering mode, you can manually trigger the U2761A by clicking **Trigger** . The U2761A initiates one sweep each time you click the button. The **Trigger**  button is illuminated while the U2761A waits for a Manual trigger.

Soft Front Panel Operation

On the Trigger Setup panel as shown in [Figure 2-28](#), select **Manual** from the drop down list at the Source panel.

Remote Interface Operation

```
TRIGger:SOURce BUS
```

When the BUS source is selected, send the TRIG or *TRG command to trigger the U2761A.

External Triggering

In the External trigger mode, the U2761A accepts a hardware trigger applied to the device Trig In connector. The U2761A initiates one sweep each time Trig In receives a TTL pulse with the specified edge.

Also refer to “Trigger Input Signal” on page 88.

Soft Front Panel Operation

On the Trigger Setup panel as shown in [Figure 2-28](#), select **External** from the drop down list at the Source panel.

To specify whether the U2761A is triggered on the rising or falling edge, select **Positive** Positive for triggering on the rising edge and **Negative** Negative for triggering on the falling edge.

Remote Interface Operation

```
TRIGger:SOURce EXTERNAL
```

Use the following command to specify whether the U2761A is triggered on the rising or falling edge.

```
TRIGger:SLOPe {POSitive|NEGative}
```

Trigger Input Signal

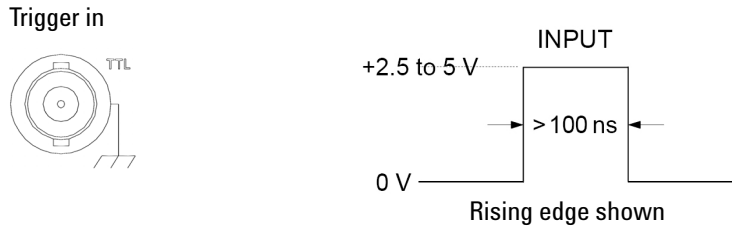

Figure 2-29 Trigger input pulse

The device connector is used for Triggered Sweep Mode, refer to “[Sweep Trigger Source](#)” on page 83. When the rising or falling edge of the TTL pulse is received on the Trig In connector, the U2761A outputs a single sweep, refer to “[External Triggering](#)” on page 87.

Trigger Output Signal

A “trigger out” signal is provided on the device Trig Out connector (*used with sweep only*). When enabled, a TTL-compatible Square waveform with either a rising (default) or falling edge is output to the device Trig Out connector at the beginning of the sweep.

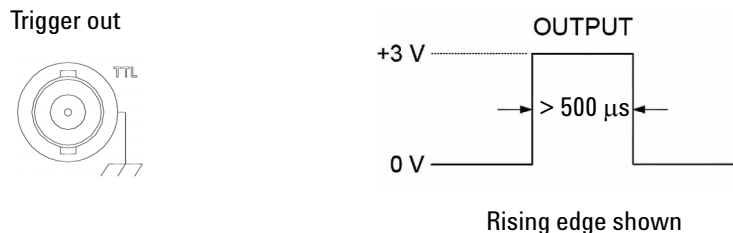

Figure 2-30 Trigger output pulse

When the *Internal* (immediate) trigger source is selected, the U2761A outputs a Square waveform with a 50% duty cycle to the Trig Out connector at the beginning of the sweep. The period of the Square waveform is equal to the specified sweep time.

When the *Manual* (software) trigger source is selected, the U2761A outputs a pulse to the Trig Out connector at the beginning of each sweep.

Soft Front Panel Operation

After enabling sweep, to specify whether the U2761A outputs a TTL-compatible Square waveform with either a rising or falling edge, select **Positive** Positive for rising edge and **Negative** Negative for falling edge.

Remote Interface Operation

```
OUTPut:TRIGger {0|OFF|1|ON}
```

```
OUTPut:TRIGger:SLOPe {POSitive|NEGative}
```

Set Triggering Using SCPI Commands

Example 1

```
-> *CLS; *RST //To reset the U2761A to
                //default power-on state,
                //this command can be
                //ignored if this operation
                //is not required.

-> FUNC SIN //Sets the carrier waveform
            //to Sine wave.

-> VOLT 5 VPP //Sets the output amplitude
            //to 5 Vpp.

-> VOLT:OFFS 0 //Sets the output offset to
            //0.

-> SWE:STAT ON //Enables frequency sweep.

-> FREQ:STAR 500 //Changes the start
                //frequency to 500 Hz.

-> FREQ:STOP 10000 //Changes the stop
                //frequency to 10 kHz.

-> SWE:SPAC LIN //Changes the sweep mode
                //to Linear.

-> SWE:TIME 2 //Changes the sweep time
                //to 2 s.

-> TRIG:SOUR IMM //Changes the sweep trigger
                //source to Internal.

-> OUTP:TRIG ON //Turns on the trigger
                //output.

-> OUTP:TRIG:SLOP POS //Outputs the trigger on a
                //rising edge.

-> OUTP ON //Turns on output.
```

Arbitrary Waveforms

There are three built-in Arbitrary waveforms offered. The U2761A supports the Arbitrary waveform up to 65536 (64K) data points. You can create an Arbitrary waveform using the soft front panel as described in the following. For further information, please refer to the *Agilent Measurement Manager help file*.

To Create and Store an Arbitrary Waveform

This section provides you an example on the procedure to create and store an Arbitrary waveform using the soft front panel. To create an Arbitrary waveform remotely, refer to the *Agilent U2761A USB Modular Function/Waveform Generator Programmer's Reference*. You will create and store the Ramp waveform shown below as an example.

Amplitude = 2 Vpp, Period = 10 ms





Figure 2-31 Ramp waveform

1 Select the Arbitrary waveform function.

Click **Arb**  to select the Arbitrary function.



2 Set the waveform period.

Select **Period**  and use the numeric keypad or numeric drop down  to set the period for the waveform.

For example, set the period of the waveform to 10 ms.



3 Set the waveform voltage limits.

Select **HiLevel**  and **LoLevel**  to set the high and low voltage levels that can be reached while editing the waveform. The upper limit *must* be greater than the lower limit.

For example, set the upper limit to 2.0 V and the lower limit to 0 V.







4 Start the Arbitrary waveform editor.

Select **Non Built-in Waveform** from the Arbitrary's drop down list  and click  to start the Arbitrary waveform editor.

5 Select the interpolation method.

Click  to enable or disable linear interpolation between the user-defined points. With interpolation enabled (default), the waveform editor makes a straight-line connection between the points. With interpolation disabled, the waveform editor maintains a constant voltage level between the points and creates a “step-like” waveform.

6 Start waveform editing process.

Click  to begin the freehand draw mode or  to enable line grid draw mode. To enable or disable the grid reference, click . Then, start drawing the desired waveform. To edit the waveform, click either  to add line/point(s),  to edit point(s),  to delete point(s), or  to clear current Arbitrary graph.

7 Sending waveform to the U2761A.

To send the waveform to the U2761A, click . Once the **Send waveform in progress** has completed, the **Send waveform has completed** message is displayed.

NOTE

The downloading of an Arbitrary waveform may take up to several minutes. The status bar at the bottom of the Arbitrary waveform editor window shows the progress of the download. Please wait for the **Send waveform has completed** message to be displayed before proceeding with the next step.



Figure 2-32 Waveform download in progress

8 Saving the waveform.

To save the waveform for future use, click . Then, select **Compatible With Intuilink** and click . Input the desired file name and click to save the file.

9 Exiting the waveform editor.

To exit the waveform editor, click .



3 Characteristics and Specifications

Product Characteristics 96

Product Specifications and Characteristics 97

This chapter specifies the characteristics, environmental conditions, and specifications of the U2761A.



Product Characteristics

REMOTE INTERFACE

- Hi-Speed USB 2.0
- USBTMC 488.2 Class device

POWER CONSUMPTION

- +12 VDC, 2 A
- Isolated ELV power source

OPERATING ENVIRONMENT

- Operating temperature from 0 °C to 50 °C
- Operating humidity at 20% to 85% RH (non-condensing)
- Altitude up to 2000 meters
- Pollution Degree 2
- For indoor use only

STORAGE COMPLIANCE

- Storage temperature from -20 °C to 70 °C
- Storage humidity at 5% to 90% RH (non-condensing)

SAFETY COMPLIANCE

Certified with:

- IEC 61010-1:2001/EN61010-1:2001 (2nd Edition)
- Canada: CAN/CSA-C22.2 No. 61010-1-04
- USA: ANSI/UL 61010-1:2004

EMC COMPLIANCE

- IEC 61326-2002/EN 61326:1997+A1:1998+A2:2001+A3:2003
- Canada: ICES-001:2004
- Australia/New Zealand: AS/NZS CISPR11:2004

SHOCK & VIBRATION

Tested to IEC/EN 60068-2

IO CONNECTOR

BNC connector

DIMENSION (W×D×H)

- 117.00 mm × 180.00 mm × 41.00 mm (with bumpers)
- 105.00 mm × 175.00 mm × 25.00 mm (without bumpers)

WEIGHT

- 528g (with bumpers)
- 476 g (without bumpers)

WARRANTY

One year

Product Specifications and Characteristics

WAVEFORMS	
Standard	Sine, Square, Ramp, Triangle, Pulse, DC
Built-in arbitrary	Exponential Rise, Exponential Fall, Negative Ramp

WAVEFORM CHARACTERISTICS			
Sine			
Frequency range	1 μ Hz to 20 MHz (1 μ Hz resolution)		
Amplitude flatness ¹ (relative to 1 kHz)	<100 kHz	0.2 dB	
	100 kHz to 1 MHz	0.35 dB	
	1 MHz to 20 MHz	0.7 dB	
Harmonic distortion ²	Frequency range	<1 Vpp	\geq 1 Vpp
	DC to 20 kHz	-70 dBc	-60 dBc
	20 kHz to 100 kHz	-65 dBc	-60 dBc
	100 kHz to 1 MHz	-50 dBc	-45 dBc
	1 MHz to 20 MHz	-40 dBc	-35 dBc
Total harmonic distortion ²	DC to 20 kHz	0.10%	
Spurious (Non-harmonic) output ³	DC to 1 MHz	-65 dBc	
	1 MHz to 20 MHz	-65 dBc + 6 dB/octave	
Phase noise (10 kHz offset)	-115 dBc/Hz (Typical)		
Square			
Frequency range	1 μ Hz to 20 MHz (1 μ Hz resolution)		
Rise/fall time	<18 ns, 10 to 90% terminated load (50 Ω)		
Overshoot	<2%		
Variable duty cycle	20% to 80% (up to 10 MHz) 40% to 60% (up to 20 MHz)		
Asymmetry (@ 50% duty)	1% of period + 5 ns		
Jitter (RMS)	> 50 kHz = 1 ns + 100 ppm of period \leq 50 kHz = 10 ns + 100 ppm of period		

3 Characteristics and Specifications

Ramp, Triangle	
Frequency range	1 μ Hz to 200 kHz (1 μ Hz resolution)
Linearity	<0.2% of peak output
Programmable symmetry	0% to 100%
Pulse	
Frequency range	500 μ Hz to 5 MHz (1 μ Hz resolution)
Pulse width (period \leq 10 s)	40 ns minimum, 10 ns resolution
Overshoot	<3%
Jitter (RMS)	300 ps + 0.1 ppm of period
Arbitrary	
Frequency range	1 μ Hz to 200 kHz (1 μ Hz resolution)
Memory depth	64 kSa
Amplitude resolution	14 bits/sample (including sign)
Sampling rate	50 MSa/s
Minimum rise/fall time	36 ns, typical
Linearity	<0.2% of peak output
Settling time	<250 ns to 0.5% of final value
Jitter (RMS)	10 ns + 30 ppm

COMMON CHARACTERISTICS	
Amplitude	
Range	40 mVpp to 5 Vpp (Into 50 Ω load) 80 mVpp to 10 Vpp (Into open circuit)
Accuracy ¹ (across 50 Ω load at 1 kHz)	±1% of settling ±5 mV (±10 mV @ Hi-Z)
Units	Vpp, Vrms, dBm
Resolution	4 digits
DC offset	
Range (peak AC + DC)	±2.5 V (Into 50 Ω load) ±5 V (Into open circuit)
Accuracy ¹ (across 50 Ω load)	±2% of offset setting ±1% of amplitude setting ±5 mV (±10 mV @ Hi-Z)
Amplitude limit	Amplitude + Offset limit to within ±2.5 V range across 50 Ω load or ±5 V across open circuit
Main output	
Impedance	50 Ω load (Typical)
Isolation	At least 42 Vpk to earth
Protection	Short-circuit protected, overload automatically disables main output
Internal frequency reference	
Accuracy ⁴	±8 ppm in 1 year
External frequency reference	
Input lock range	10 MHz ± 170 Hz
Input amplitude level	500 mVpp to 5 Vpp
Impedance	50 Ω AC coupled
Lock time	<2 s
Output frequency	10 MHz
Output amplitude level	632 mVpp, typical
Impedance	Return loss 10 dB typical at 10 MHz
Phase offset	
Range	+360° to -360°
Resolution	0.01°
Accuracy	20 ns

3 Characteristics and Specifications

MODULATION	
AM	
Carrier waveforms	Sine, Square, Ramp, Arbitrary
Source	Internal
Internal modulation	Sine, Square, Ramp, Arbitrary (2 mHz to 20 kHz)
Depth	0.0% to 100.0%
FM	
Carrier waveforms	Sine, Square, Ramp, Arbitrary
Source	Internal
Internal modulation	Sine, Square, Ramp, Arbitrary (2 mHz to 20 kHz)
Deviation	1 Hz to 500 kHz
PM	
Carrier waveforms	Sine, Square, Ramp, Arbitrary
Source	Internal
Internal modulation	Sine, Square, Ramp, Arbitrary (2 mHz to 20 kHz)
Deviation	0.0 to 360.0°
FSK	
Carrier waveforms	Sine, Square, Ramp, Arbitrary
Source	Internal
Internal modulation	50% duty cycle square (2 mHz to 100 kHz)
PSK	
Carrier waveforms	Sine, Square, Ramp, Arbitrary
Source	Internal
Internal modulation	50% duty cycle square (2 mHz to 100 kHz)
Deviation	0.0 to 360.0°
ASK	
Carrier waveforms	Sine, Square, Ramp, Arbitrary
Source	Internal
Internal modulation	50% duty cycle square (2 mHz to 100 kHz)

SWEEP CHARACTERISTICS	
Waveforms	Sine, Square, Ramp, Arbitrary
Type	Linear or Logarithmic
Direction	Up or Down
Sweep time	1 ms to 500 s
Trigger	Single, External, or Internal

TRIGGER CHARACTERISTICS	
Trigger input	
Input level	TTL compatible
Slope	Rising or Falling, Selectable
Pulse width	>100 ns
Input impedance	>10 k Ω , DC coupled
Latency	<500 ns
Jitter (RMS)	6 ns (3.5 ns for Pulse)
Trigger output	
Input level	TTL compatible into ≥ 1 k Ω
Pulse width	>400 ns
Output impedance	50 Ω , typical
Fanout	4 TTL
Rise time	≤ 20 ns

- 1 Add 1/10th of output amplitude and offset specification per °C for operation outside the range of 18 °C to 28 °C.
- 2 DC offset set to 0 V.
- 3 Typical spurious output at low amplitude is -70 dBm.
- 4 Add 1 ppm/°C (average) for operation outside the range of 18 °C to 28 °C.

3 Characteristics and Specifications

Index

A

- Accuracy [99](#)
- Agilent
 - Automation-Ready CD [7](#), [10](#), [11](#)
 - Connection Expert [19](#)
 - IO Libraries Suite 14.2 [10](#)
 - Measurement Manager [10](#), [15](#), [21](#), [91](#)
 - Sales Office [7](#), [8](#)
 - VEE Pro [9](#)
- AM [2](#), [26](#), [40](#), [49](#), [50](#), [52](#), [54](#), [100](#)
 - Carrier frequency [51](#)
 - Carrier waveform [50](#), [100](#)
 - depth [100](#)
 - Modulating Waveform [52](#)
 - Modulating waveform frequency [53](#)
 - Modulation Depth [53](#)
 - SCPI commands [54](#)
 - Soft Front Panel Operation [50](#)
- APPLY [29](#), [31](#), [33](#), [34](#), [39](#), [41](#), [42](#), [51](#), [52](#), [57](#), [58](#), [63](#)
- Arbitrary waveform [2](#), [26](#), [29](#), [50](#), [56](#), [62](#), [67](#), [72](#), [77](#), [91](#), [92](#), [93](#), [98](#)
- ASK [2](#), [26](#), [76](#), [79](#), [100](#)
 - carrier frequency [78](#)
 - carrier waveform [77](#), [100](#)
 - rate [79](#)
 - SCPI commands [79](#)
 - soft front panel operation [77](#)
- Asymmetry [97](#)

B

- browser [10](#)

- bus trigger [89](#)

C

- carrier
 - frequency [51](#), [57](#), [63](#), [68](#), [73](#), [78](#)
 - waveform [49](#), [50](#), [55](#), [56](#), [61](#), [62](#), [67](#), [72](#), [77](#), [100](#)
- characteristics
 - common [99](#)
 - product [96](#)
 - specifications/measurement [97](#)
 - sweep [101](#)
 - trigger [101](#)
 - waveform [97](#)
- compliance
 - EMC [96](#)
 - safety [96](#)
 - storage [96](#)
- configuration
 - output [26](#), [35](#), [36](#)
 - pin [23](#)

D

- DC offset [33](#), [99](#), [101](#)
- DDS [2](#)
- depth [49](#), [53](#), [54](#), [98](#), [100](#)
- deviation
 - frequency [55](#), [57](#), [59](#), [60](#), [100](#)
 - phase [61](#), [65](#), [100](#)
 - PSK [74](#), [75](#), [100](#)
- dimensions [5](#), [6](#), [96](#)
- duty cycle [30](#), [38](#), [39](#), [40](#), [43](#), [47](#), [48](#), [52](#), [58](#), [64](#), [89](#), [97](#), [100](#)

F

- firmware [18](#), [19](#)
- FM
 - carrier frequency [57](#)
 - carrier waveform [56](#), [100](#)
 - frequency deviation [59](#), [100](#)
 - modulating waveform [58](#)
 - modulating waveform frequency [59](#)
 - SCPI commands [60](#)
- FSK
 - "Hop" frequency [69](#)
 - carrier frequency [68](#)
 - carrier waveform [67](#), [100](#)
 - rate [70](#)
 - SCPI commands [70](#)

H

- Harmonic distortion [97](#)
- humidity
 - operating [96](#)
 - storage [96](#)

I

- installation
 - Agilent
 - Measurement Manager [13](#)
 - chassis [24](#)
 - IO Libraries Suite [11](#)
 - module driver [12](#)
- Isolation [99](#)

J

- jitter [97](#), [98](#)

Index

L

limits

- amplitude 27, 33
- duty cycle 30
- frequency 38
- function 27, 30
- offset voltage 31
- output termination 31
- units selection 32

L-Mount kit 7, 24

O

output

- amplitude 31, 33, 35, 36, 99
- control 41
- frequency 29, 99
- function 26
- SCPI commands 42
- sweep 80, 83
- termination 36
- units 35

P

phase noise 97

PM

- carrier frequency 63
- carrier waveform 62, 100
- modulating waveform 64
- modulating waveform frequency 64
- phase deviation 65, 100
- SCPI commands 65

prerequisites 10

product

- dimensions 5, 96
- outlook 3
- specifications 97

Programmable symmetry 98

protection 99

PSK

- carrier frequency 73
- carrier waveform 72, 100
- deviation 74, 100
- rate 74
- SCPI commands 75

pulse

- duty cycle 47
- period 45
- SCPI commands 48
- waveform 45
- width 46, 98, 101

R

Ramp 40, 44, 98

remote interface 96

resolution 99

rise/fall time 97

RMS 97, 98, 101

S

sampling rate 98

settling time 98

shock 96

spurious 97, 101

start frequency 81

stop frequency 81

storage humidity 96

storage temperature 96

Sweep 80

sweep

- mode 82
- SCPI commands 84
- time 82, 83, 101
- trigger source 83

symmetry 40

T

triggering

- External 85, 87
- input signal 88, 101
- Internal 85, 86, 89
- Manual 85, 86, 89
- output signal 88, 101
- SCPI commands 90

W

warranty 96

weight 96

www.agilent.com

Contact us

To obtain service, warranty or technical support assistance, contact us at the following phone numbers:

United States:

(tel) 800 829 4444 (fax) 800 829 4433

Canada:

(tel) 877 894 4414 (fax) 800 746 4866

China:

(tel) 800 810 0189 (fax) 800 820 2816

Europe:

(tel) 31 20 547 2111

Japan:

(tel) (81) 426 56 7832 (fax) (81) 426 56 7840

Korea:

(tel) (080) 769 0800 (fax) (080) 769 0900

Latin America:

(tel) (305) 269 7500

Taiwan:

(tel) 0800 047 866 (fax) 0800 286 331

Other Asia Pacific Countries:

(tel) (65) 6375 8100 (fax) (65) 6755 0042

Or visit Agilent worldwide web at:

www.agilent.com/find/assist

Product specifications and descriptions in this document are subject to change without notice. Always refer to Agilent web site for latest revision.

© Agilent Technologies, Inc., 2008-2009

Third Edition, January 31, 2009
U2761-90000



Agilent Technologies

Free Manuals Download Website

<http://myh66.com>

<http://usermanuals.us>

<http://www.somanuals.com>

<http://www.4manuals.cc>

<http://www.manual-lib.com>

<http://www.404manual.com>

<http://www.luxmanual.com>

<http://aubethermostatmanual.com>

Golf course search by state

<http://golfingnear.com>

Email search by domain

<http://emailbydomain.com>

Auto manuals search

<http://auto.somanuals.com>

TV manuals search

<http://tv.somanuals.com>