

---

# Service Guide

Publication number 01664-97005  
Second edition, January 2000

For Safety information, Warranties, and Regulatory information, see the pages at the end of the book.

© Copyright Agilent Technologies 1987-2000  
All Rights Reserved.

---

## Agilent Technologies 1664A Logic Analyzer

---

# Agilent Technologies 1664A Logic Analyzer

The Agilent Technologies 1664A is a 50-MHz State/500-MHz Timing Logic Analyzer.

## Features

Some of the main features of the 1664A Logic Analyzer is as follows:

- 32 data channels and 2 clock/data channels
- 3.5-inch disk drive
- Centronix (parallel) interface (with GPIB and RS-232C interfaces available as options)
- Variable setup/hold time
- 4 kbytes deep memory on all channels with 8 kbytes in half channel mode
- Marker measurements
- 12 levels of trigger sequencing for state and 10 levels of sequential triggering for timing
- 100 MHz time and number-of-states tagging
- Full programmability (with optional interface)

## Service Strategy

The service strategy for this instrument is the replacement of defective assemblies. This service guide contains information for finding a defective assembly by testing and servicing the 1664A.

This logic analyzer can be returned to Agilent Technologies for all service work, including troubleshooting. Contact your nearest Agilent Technologies Sales Office for more details.

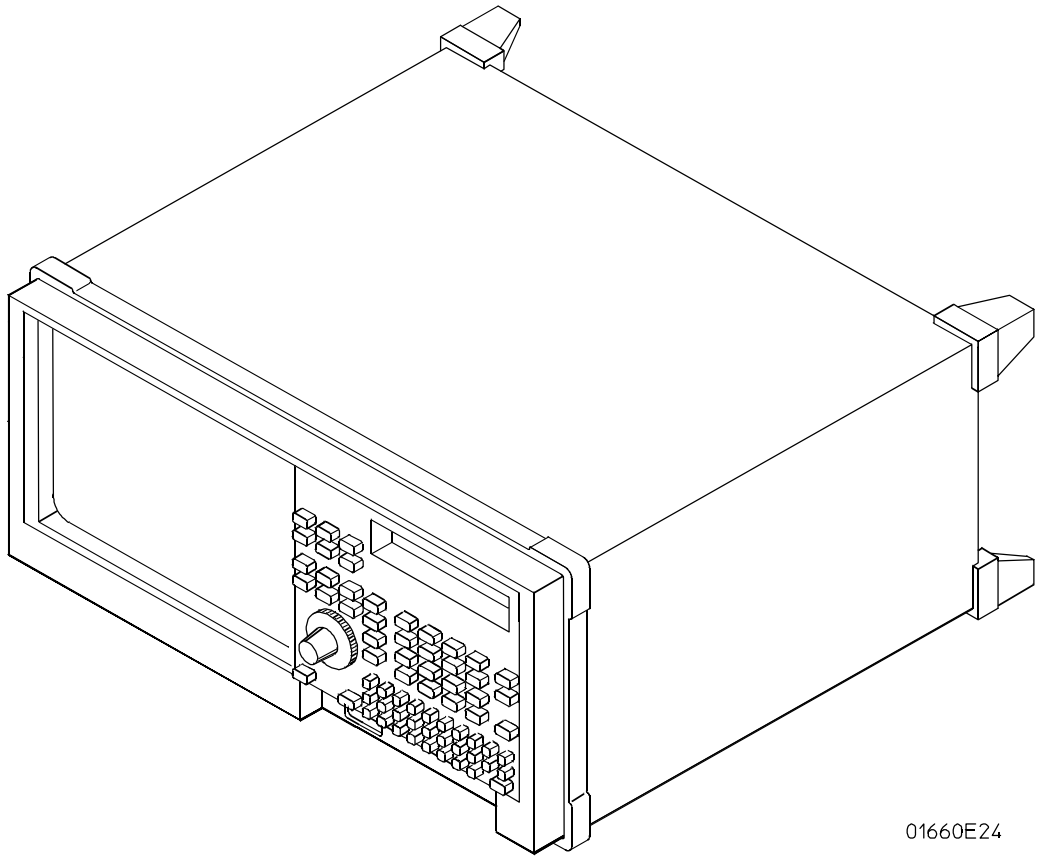

01660E24

**The Agilent Technologies 1664A Logic Analyzer**

---

## In This Book

This book is the service guide for the 1664A Logic Analyzers and is divided into eight chapters.

Chapter 1 contains information about the logic analyzer and includes accessories, specifications and characteristics, and equipment required for servicing.

Chapter 2 tells how to prepare the logic analyzer for use.

Chapter 3 gives instructions on how to test the performance of the logic analyzer.

Chapter 4 contains calibration instructions for the logic analyzer.

Chapter 5 contains self-tests and flowcharts for troubleshooting the logic analyzer.

Chapter 6 tells how to replace assemblies of the logic analyzer and how to return them to Agilent Technologies.

Chapter 7 lists replaceable parts, shows an exploded view, and gives ordering information.

Chapter 8 explains how the logic analyzer works and what the self-tests are checking.

---

# Table of Contents

## 1 General Information

- Accessories 1-2
- Specifications 1-3
- Characteristics 1-3
- Supplemental Characteristics 1-4
- Recommended Test Equipment 1-8

## 2 Preparing for Use



- To inspect the logic analyzer 2-2
- Ferrites 2-3
- To apply power 2-4
- To operate the user interface 2-4
- To set the line voltage 2-4
- To degauss the display 2-5
- To clean the logic analyzer 2-5
- To test the logic analyzer 2-5

## 3 Testing Performance

- To perform the self-tests 3-3
- To make the test connectors 3-6
- To test the threshold accuracy 3-8
  - Set up the equipment 3-8
  - Set up the logic analyzer 3-9
  - Connect the logic analyzer 3-9
  - Test the TTL threshold 3-10
  - Test the ECL threshold 3-12
  - Test the – User threshold 3-13
  - Test the + User threshold 3-14
  - Test the 0 V User threshold 3-15
  - Test the next pod 3-16
- To test the glitch capture 3-17
  - Set up the equipment 3-17
  - Set up the logic analyzer 3-18
  - Connect the logic analyzer 3-18
  - Test the glitch capture on the connected channels 3-20
  - Test the next channels 3-22
- To test the single-clock, single-edge, state acquisition 3-23
  - Set up the equipment 3-23
  - Set up the logic analyzer 3-24
  - Connect the logic analyzer 3-26
  - Verify the test signal 3-27
  - Check the setup/hold combination 3-29

- To test the multiple-clock, multiple-edge, state acquisition 1-34
  - Set up the equipment 1-34
  - Set up the logic analyzer 1-35
  - Connect the logic analyzer 1-37
  - Verify the test signal 1-38
  - Check the setup/hold with single clock edges, multiple clocks 1-40
- To test the single-clock, multiple-edge, state acquisition 1-45
  - Set up the equipment 1-45
  - Set up the logic analyzer 1-46
  - Connect the logic analyzer 1-48
  - Verify the test signal 1-49
  - Check the setup/hold combination 1-51
- To test the time interval accuracy 1-54
  - Set up the equipment 1-54
  - Set up the logic analyzer 1-55
  - Connect the logic analyzer 1-57
  - Acquire the data 1-58

Performance Test Record 3-59

#### **4 Calibrating and Adjusting**

- Logic analyzer calibration 4-2
- Set up the equipment 4-2
- To adjust the CRT monitor alignment 4-3
- To adjust the CRT intensity 4-5

#### **5 Troubleshooting**

- To use the flowcharts 5-2
- To check the power-up tests 5-15
- To run the self-tests 5-16
- To test the power supply voltages 5-21
- To test the CRT monitor signals 5-23
- To test the keyboard signals 5-24
- To test the disk drive voltages 5-25
- To perform the BNC test 5-27
- To test the logic analyzer probe cables 5-28
- To test the auxiliary power 5-32

#### **6 Replacing Assemblies**

- To remove and replace the handle 6-5
- To remove and replace the feet and tilt stand 6-5
- To remove and replace the cover 6-5
- To remove and replace the disk drive 6-6
- To remove and replace the power supply 6-7

- To remove and replace the Main Circuit board 6-7
- To remove and replace the switch actuator assembly 6-8
- To remove and replace the rear panel assembly 6-9
- To remove and replace the front panel and keyboard 6-10
- To remove and replace the intensity adjustment 6-10
- To remove and replace the monitor 6-11
- To remove and replace the handle plate 6-11
- To remove and replace the fan 6-12
- To remove and replace the line filter 6-12
- To remove and replace the optional GPIB and RS-232C cables 6-13
- To return assemblies 6-14

## **7 Replaceable Parts**

- Replaceable Parts Ordering 7-2
- Exploded View 7-3
- Replaceable Parts List 7-4
- Power Cables and Plug Configurations 7-8

## **8 Theory of Operation**

- Block-Level Theory 8-3
  - The 1664A Logic Analyzer 8-3
  - The Logic Acquisition Circuitry 8-6
- Self-Tests Description 8-9
  - Power-up Self-Tests 8-9
  - System Tests (System PV) 8-10
  - Analyzer Tests (Analy PV) 8-13
- GPIB (Optional) 8-15
- RS-232C(Optional) 8-16
- Centronix 8-17

## Contents



Accessories 1-2  
Specifications 1-3  
Characteristics 1-3  
Supplemental Characteristics 1-4  
Recommended Test Equipment 1-8

---

## General Information

---

# General Information

This chapter lists the accessories, the specifications and characteristics, and the recommended test equipment.

---

## Accessories

The following accessories are supplied with the 1664A Logic Analyzers.

<b>Accessories Supplied</b>	<b>Part Number</b>	<b>Qty</b>
Probe tip assemblies	01650-61608	2
Probe cables	16550-61601	1
Grabbers (20 per pack)	5090-4356	2
Probe ground (5 per pack)	5959-9334	2
User's Reference	01660-90904	1
Accessories Pouch	01660-84501	1
HIL Mouse	A2838A	1

### Accessories Available

Other accessories available for the 1664A Logic Analyzer are listed in the *Accessories for Agilent Logic Analyzers* brochure. The table below lists additional documentation that is available from your nearest Agilent Technologies sales office for use with your logic analyzer.

<b>Accessories Available</b>	<b>Part Number</b>
Demo Training Kit	E2433-60007
Programming Reference	01660-90933
Service Guide	01664-97005

---

## Specifications

The specifications are the performance standards against which the product is tested.

Maximum State Speed	50 MHz
Minimum State Clock Pulse Width*	3.5 ns
Minimum Master to Master Clock Time*	20.0 ns
Minimum Glitch Width*	3.5 ns
Threshold Accuracy	± (100 mV + 3% of threshold setting)
Setup/Hold Time:*	
Single Clock, Single Edge	0.0/3.5 ns through 3.5/0.0 ns, adjustable in 500-ps increments
Single Clock, Multiple Edges	0.0/4.0 ns through 4.0/0.0 ns, adjustable in 500-ps increments
Multiple Clocks, Multiple Edges	0.0/4.5 ns through 4.5/0.0 ns, adjustable in 500-ps increments

\* Specified for an input signal  $V_H = -0.9\text{ V}$ ,  $V_L = -1.7\text{ V}$ , slew rate = 1 V/ns, and threshold = -1.3 V.

---

## Characteristics

These characteristics are not specifications, but are included as additional information.

	Full Channel	Half Channel
Maximum State Clock Rate	50 MHz	50 MHz
Maximum Conventional Timing Rate	250 MHz	500 MHz
Maximum Transitional Timing Rate	125 MHz	250 MHz
Maximum Timing with Glitch Rate	N/A	125 MHz
Memory Depth	4K	8K*
Channel Count:	34	17

\* For all modes except glitch.

## Supplemental Characteristics

### Probes

Input Resistance	100 k $\Omega$ , $\pm$ 2%
Input Capacitance	~ 8 pF
Minimum Voltage Swing	500 mV, peak-to-peak
Threshold Range	$\pm$ 6.0 V, adjustable in 50-mV increments

### State Analysis

State/Clock Qualifiers	6
Time Tag Resolution*	8 ns or 0.1%, whichever is greater
Maximum Time Count Between States	34 seconds
Maximum State Tag Count*	$4.29 \times 10^9$

### Timing Analysis

Sample Period Accuracy	0.01 % of sample period
Channel-to-Channel Skew	2 ns, typical
Time Interval Accuracy	$\pm$ [sample period + channel-to-channel skew + (0.01%)(time reading)]

### Triggering

Sequencer Speed	125 MHz, maximum
State Sequence Levels	12
Timing Sequence Levels	10
Maximum Occurrence Counter Value	1,048,575
Pattern Recognizers	10
Maximum Pattern Width	34 channels
Range Recognizers	2
Range Width	32 bits each
Timers	2
Timer Value Range	400 ns to 500 seconds
Glitch/Edge Recognizers	2 (timing only)
Maximum Glitch/Edge Width	34 channels

\*Maximum state clock rate with time or state tags on is 50 MHz. When all pods are assigned to a state or timing machine, time or state tags halve the memory depth.

## Measurement and Display Functions

**Displayed Waveforms** 24 lines maximum, with scrolling across 96 waveforms.

## Measurement Functions

**Run/Stop Functions** Run starts acquisition of data in specified trace mode.

**Stop** In single trace mode or the first run of a repetitive acquisition, Stop halts acquisition and displays the current acquisition data. For subsequent runs in repetitive mode, Stop halts acquisition of data and does not change the current display.

**Trace Mode** Single mode acquires data once per trace specification. Repetitive mode repeats single mode acquisitions until Stop is pressed or until the time interval between two specified patterns is less than or greater than a specified value, or within or not within a specified range.

## Indicators

**Activity Indicators** Provided in the Configuration and Format menus for identifying high, low, or changing states on the inputs.

**Markers** Two markers (X and O) are shown as vertical dashed lines on the display.

**Trigger** Displayed as a vertical dashed line in the Timing Waveform display and as line 0 in the State Listing display.

## Data Entry/Display

**Labels** Channels may be grouped together and given a 6-character name. Up to 126 labels in each analyzer may be assigned with up to 32 channels per label.

**Display Modes** State listing, State Waveforms, Chart, Compare Listing, Compare Difference Listing, Timing Waveforms, and Timing Listings. State Listing and Timing Waveforms can be time-correlated on the same displays.

**Timing Waveform** Pattern readout of timing waveforms at X or O marker.

**Bases** Binary, Octal, Decimal, Hexadecimal, ASCII (display only), Two's Complement, and User-defined symbols.

**Symbols** 1,000 maximum. Symbols can be downloaded over RS-232 or GPIB.

**Marker Functions**

**Time Interval** The X and O markers measure the time interval between a point on a timing waveform and the trigger, two points on the same timing waveform, two points on different waveforms, or two states (time tagging on).

**Delta States (state analyzer only)** The X and O markers measure the number of tagged states between one state and trigger or between two states.

**Patterns** The X and O markers can be used to locate the *n*th occurrence of a specified pattern from trigger, or from the beginning of data. The O marker can also find the *n*th occurrence of a pattern from the X marker.

**Statistics** X and O marker statistics are calculated for repetitive acquisitions. Patterns must be specified for both markers, and statistics are kept only when both patterns can be found in an acquisition. Statistics are minimum X to O time, maximum X to O time, average X to O time, and ratio of valid runs to total runs.

**Auxiliary Power**

Power Through Cables 1/3 amp at 5 V maximum per cable

**Operating Environment**

Temperature Instrument, 0 °C to 55 °C (+32 °F to 131 °F).  
 Probe lead sets and cables, 0 °C to 65 °C (+32 °F to 149 °F).

Humidity Instrument, probe lead sets, and cables, up to 95% relative humidity at +40 °C (+122 °F).

Altitude To 4600 m (15,000 ft).

Vibration Operating: Random vibration 5 to 500 Hz, 10 minutes per axis, ≈0.3 g (rms).  
 Non-operating: Random vibration 5 to 500 Hz, 10 minutes per axis, ≈ 2.41 g (rms); and swept sine resonant search, 5 to 500 Hz, 0.75 g (0-peak), 5 minute resonant dwell at 4 resonances per axis.

**Dimensions**

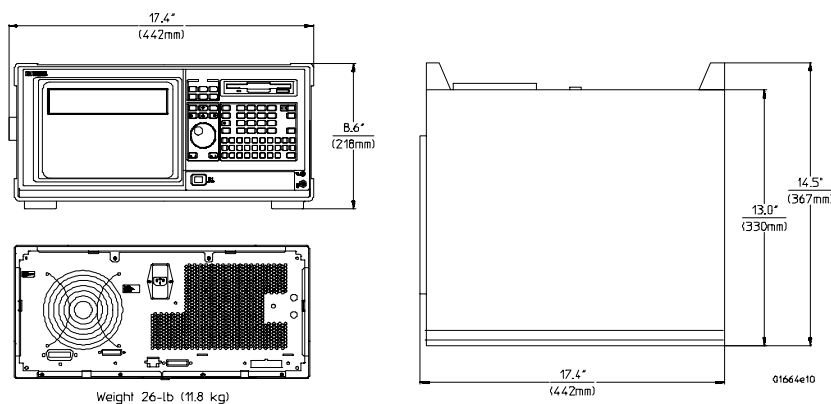

**Product Regulations**

Safety	IEC 348 UL 1244 CSA Standard C22.2 No.231 (Series M-89)		
EMC	This product meets the requirement of the European Communities (EC) EMC Directive 89/336/EEC.		
Emissions	EN55011/CSIPR 11 (ISM, Group1, Class A equipment) SABS RAA Act No. 24(1990)		
Immunity	EN50082-1	Code <sup>1</sup>	Notes <sup>2</sup>
	IEC 801-2 (ESD)4kV CD, 8kV AD	2	
	IEC 801-3 (Rad.) 3V/m	1	
	IEC 801-4 (EFT) 1kV	2	

<sup>1</sup>Performance Codes:

- 1 PASS - Normal operations, no effect.
- 2 PASS - Temporary degradation, self recoverable.
- 3 PASS - Temporary degradation, operator intervention required.
- 4 FAIL - Not recoverable, component damage.

<sup>2</sup>Notes: (None)

---

## Recommended Test Equipment

---

### Equipment Required

Equipment	Critical Specifications	Recommended Model/Part	Use*
Pulse Generator	100 MHz, 3.5 ns pulse width, < 600 ps rise time	Agilent 8131A Option 020	P, T
Digitizing Oscilloscope	≥ 6 GHz bandwidth, < 58 ps rise time	Agilent 54121T	P
Function Generator	Accuracy ≤ (5)(10 <sup>-6</sup> ) × frequency, DC offset voltage ±6.3 V	Agilent 3325B Option 002	P
Digital Multimeter	0.1 mV resolution, 0.005% accuracy	Agilent 3458A	P
BNC-Banana Cable		Agilent 11001-60001	P
BNC Tee	BNC (m)(f)(f)	Agilent 1250-0781	P
Cable	BNC (m)(m) 48 inch > 2GHz bandwidth	Agilent 8120-1840	P, T
SMA Coax Cable (Qty 3)	18 GHz bandwidth	Agilent 8120-4948	P
Adapter (Qty 4)	SMA(m)-BNC(f)	Agilent 1250-1200	P, T
Adapter	SMA(f)-BNC(m)	Agilent 1250-2015	P
Coupler (Qty 4)	BNC (m)(m)	Agilent 1250-0216	P, T
20:1 Probes (Qty 2)		Agilent 54006A	P
BNC Test Connector, 17x2 (Qty 1)**			P
BNC Test Connector, 6x2 (Qty 4)**			P, T
Digitizing Oscilloscope	> 100 MHz Bandwidth	Agilent 54600A	T
BNC Shorting Cap		Agilent 1250-0074	T
BNC-Banana Adapter		Agilent 1251-2277	T
Light Power Meter		United Detector 351	A
Alignment Tool		8710-1300	A

\*A = Adjustment P = Performance Tests T = Troubleshooting

\*\*Instructions for making these test connectors are in chapter 3, "Testing Performance."



To inspect the logic analyzer 2-2  
Ferrites 2-3  
To apply power 2-4  
To operate the user interface 2-4



To set the line voltage 2-4  
To degauss the display 2-5  
To clean the logic analyzer 2-5  
To test the logic analyzer 2-5

---

## Preparing for Use

---

# Preparing For Use

This chapter gives you instructions for preparing the logic analyzer for use.

## **Power Requirements**

The logic analyzer requires a power source of either 115 Vac or 230 Vac, -22 % to +10 %, single phase, 48 to 66 Hz, 200 Watts maximum power.

## **Operating Environment**

The operating environment is listed in chapter 1. Note the noncondensing humidity limitation. Condensation within the instrument can cause poor operation or malfunction. Provide protection against internal condensation.

The logic analyzer will operate at all specifications within the temperature and humidity range given in chapter 1. However, reliability is enhanced when operating the logic analyzer within the following ranges:

- Temperature: +20 °C to +35 °C (+68 °F to +95 °F)
- Humidity: 20% to 80% noncondensing

## **Storage**

Store or ship the logic analyzer in environments within the following limits:

- Temperature: -40 °C to + 75 °C
- Humidity: Up to 90% at 65 °C
- Altitude: Up to 15,300 meters (50,000 feet)

Protect the logic analyzer from temperature extremes which cause condensation on the instrument.

---

## To inspect the logic analyzer

### **1 Inspect the shipping container for damage.**

If the shipping container or cushioning material is damaged, keep them until you have checked the contents of the shipment and checked the instrument mechanically and electrically.

### **2 Check the supplied accessories.**

Accessories supplied with the logic analyzer are listed in "Accessories" in chapter 1.

### **3 Inspect the product for physical damage.**

Check the logic analyzer and the supplied accessories for obvious physical or mechanical defects. If you find any defects, contact your nearest Agilent Technologies Sales Office. Arrangements for repair or replacement are made, at Agilent Technologies' option, without waiting for a claim settlement.

## Ferrites

Ferrites are included in the 1664A accessory pouch for the logic analyzer cable. When properly installed, the ferrites reduce RFI emissions from the logic analyzer.

In order to ensure compliance of the 1664A Logic Analyzer to the CISPR11 Class A radio frequency interference (RFI) limits, you must install the ferrite to absorb radio frequency energy.

Note: Adding or removing the ferrite will not affect the normal operation of the analyzer.

### Ferrite Installation Instructions

Use the following steps to install the ferrite on the logic analyzer cable.

- 1 Place the ferrite halves and spacer on the logic analyzer cable like a clamshell around the whole cable. The ferrite should be 10 cm (about 4 in) from the the end of the cable shell as shown.

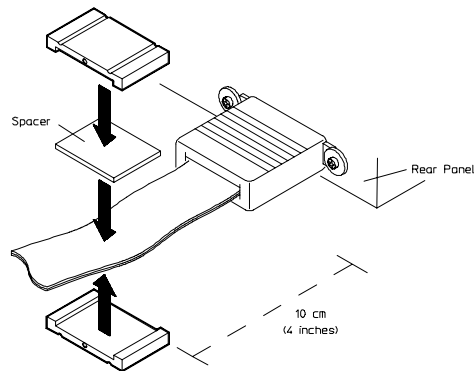

- 2 Insert the clamps onto the ends of the ferrites. The locking tab should fit cleanly in the ferrite grooves.

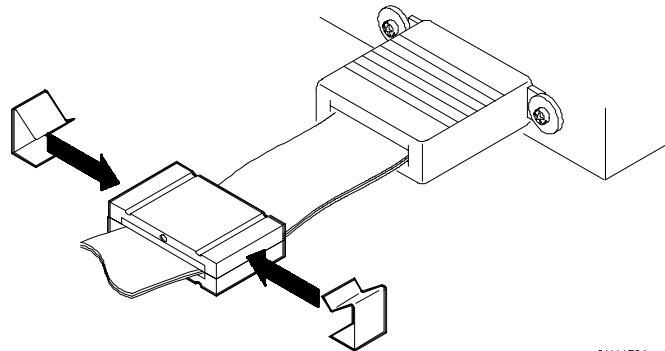

When properly installed, the ferrite should appear on the logic analyzer cable as shown.

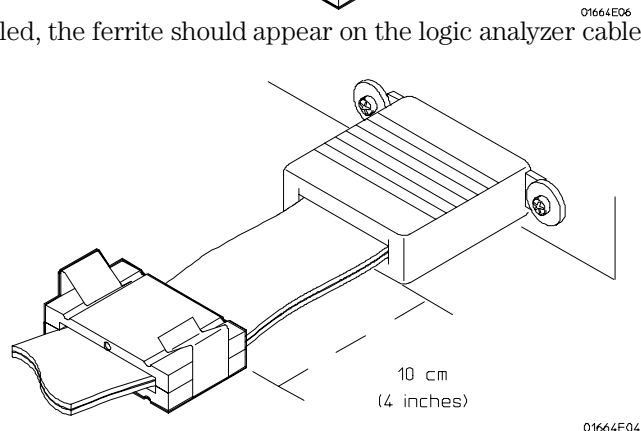

---

## To apply power

---

### CAUTION

Electrostatic discharge can damage electronic components. Use grounded wriststraps and mats when performing any service to the logic analyzer.

- 1 Check that the line voltage selector, located on the rear panel, is on the correct setting and the correct fuse is installed.

See also, "To set the line voltage" on this page.

- 2 Connect the power cord to the instrument and to the power source.

This instrument is equipped with a three-wire power cable. When connected to an appropriate ac power outlet, this cable grounds the instrument cabinet. The type of power cable plug shipped with the instrument depends on the country of destination. Refer to chapter 7, "Replaceable Parts," for option numbers of available power cables and plug configurations.

- 3 Turn on the instrument power switch located on the front panel.

---

## To operate the user interface

To select a field on the logic analyzer screen, use the arrow keys to highlight the field, then press the Select key. For more information about the logic analyzer interface, refer to the *Agilent Technologies 1660 Series Logic Analyzer User's Reference*.

To set the GPIB address or to configure for RS-232C, refer to the *Agilent Technologies 1660 Series Logic Analyzer User's Reference*.

---

## To set the line voltage

When shipped from the factory, the line voltage selector is set and an appropriate fuse is installed for operating the instrument in the country of destination. To operate the instrument from a power source other than the one set, perform the following steps.

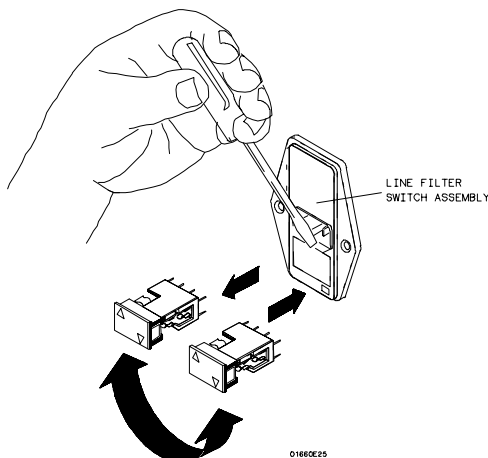

- 1 Turn the power switch to the Off position, then remove the power cord from the instrument.

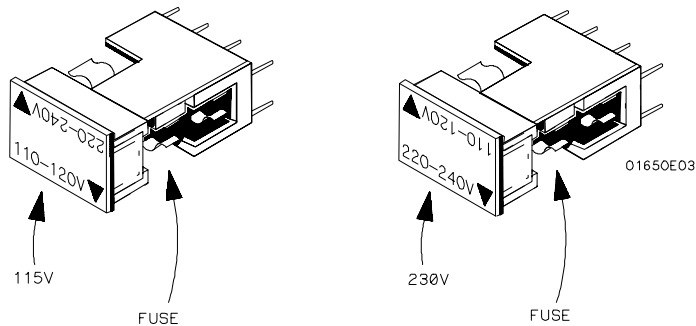

- 2 Remove the fuse module by carefully prying at the top center of the fuse module until you can grasp it and pull it out by hand.
- 3 Reinsert the fuse module with the arrow for the appropriate line voltage aligned with the arrow on the line filter assembly switch.
- 4 Reconnect the power cord. Turn on the instrument by setting the power switch to the On position.

---

## To degauss the display

If the logic analyzer has been subjected to strong magnetic fields, the CRT might become magnetized and display data might become distorted. To correct this condition, degauss the CRT with a conventional external television type degaussing coil.

---

## To clean the logic analyzer

With the instrument turned off and unplugged, use mild soap and water to clean the front and cabinet of the logic analyzer. Harsh soap might damage the water-base paint.

---

## To test the logic analyzer

- If you require a test to verify the specifications, start at the beginning of chapter 3, "Testing Performance."
- If you require a test to initially accept the operation, perform the self-tests in chapter 3.
- If the logic analyzer does not operate correctly, go to the beginning of chapter 5, "Troubleshooting."



To perform the self-tests 3-3  
To make the test connectors 3-6  
To test the threshold accuracy 3-8  
To test the glitch capture 3-17  
To test the single-clock, single-edge, state acquisition 3-23  
To test the multiple-clock, multiple-edge, state acquisition 3-34  
To test the single-clock, multiple-edge, state acquisition 3-45  
To test the time interval accuracy 3-54  
Performance Test Record 3-59

---

## Testing Performance

---

# Testing Performance

This chapter tells you how to test the performance of the logic analyzer against the specifications listed in chapter 1. To ensure the logic analyzer is operating as specified, you perform software tests (self-tests) and manual performance tests on the analyzer. The logic analyzer is considered performance-verified if all of the software tests and manual performance tests have passed. The procedures in this chapter indicate what constitutes a "Pass" status for each of the tests.

## **The Logic Analyzer Interface**

To select a field on the logic analyzer screen, use the arrow keys to highlight the field, then press the Select key. For more information about the logic analyzer interface, refer to the *Agilent Technologies 1660 Series Logic Analyzer User's Reference*.

## **Test Strategy**

For a complete test, start at the beginning with the software tests and continue through to the end of the chapter. For an individual test, follow the procedure in the test. The examples in this chapter were performed using an 1664A.

The performance verification procedures starting on page 3-8 are each shown from power-up. To exactly duplicate the set-ups in the tests, save the power-up configuration to a file on a disk, then load that file at the start of each test.

If a test fails, check the test equipment set-up, check the connections, and verify adequate grounding. If a test still fails, the most probable cause of failure would be the main circuit board.

## **Test Interval**

Test the performance of the logic analyzer against specifications at two-year intervals or if it is replaced or repaired.

## **Performance Test Record**

A performance test record for recording the results of each procedure is located at the end of this chapter. Use the performance test record to gauge the performance of the logic analyzer over time.

## **Test Equipment**

Each procedure lists the recommended test equipment. You can use equipment that satisfies the specifications given. However, the procedures are based on using the recommended model or part number. Before testing the performance of the logic analyzer, warm-up the instrument and the test equipment for 30 minutes.



## To perform the self-tests

The self-tests verify the correct operation of the logic analyzer. Self-tests can be performed all at once or one at a time. While testing the performance of the logic analyzer, run the self-tests all at once.

- 1 Disconnect all inputs, insert the boot disk, then turn on the power switch. Wait until the power-up tests are complete.
- 2 Press the System key. Select the field next to System, then select Test in the pop-up menu then press the Select key.

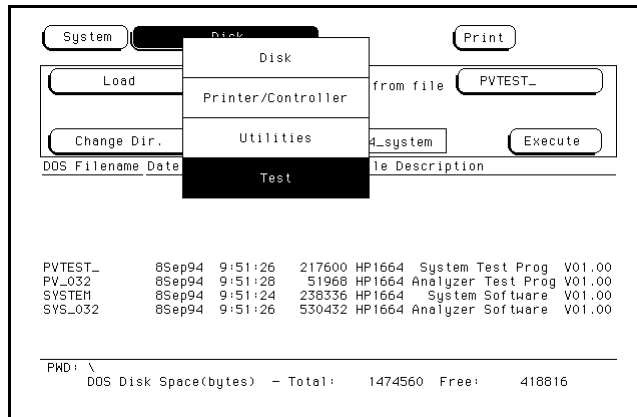

- 3 Select the box labeled Load Test System then press the Select key. Load the disk containing the performance verification (self-tests) into the disk drive (normally the same as the boot disk).
- 4 Select the box labeled Continue and press the Select key.
- 5 After the test files have been loaded, the Analy PV menu is displayed. Select All Analyzer Tests.

You can run all tests at one time, except for the Data Input Inspection, by running All Analyzer Tests. To see more details about each test when troubleshooting failures, you can run each test individually. This example shows how to run all tests at once.

When the tests finish, the status for each test shows Passed or Failed, and the status for the All Analyzer Tests changes from Untested to Tested.

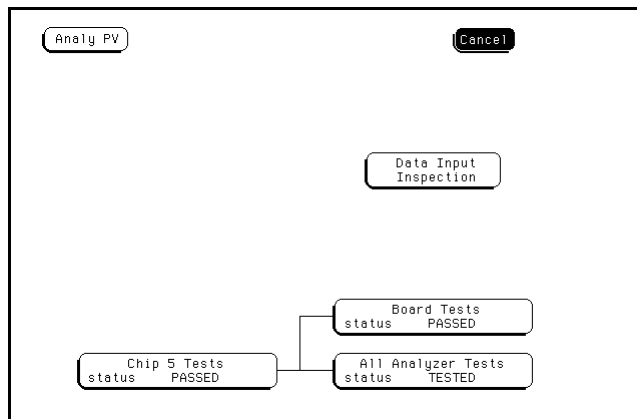

- 6 Select Analy PV, then select Sys PV in the pop-up menu.

- 7 Select the Printer/Controller field next to Sys PV, then select System Test in the pop-up menu then press the Select key.

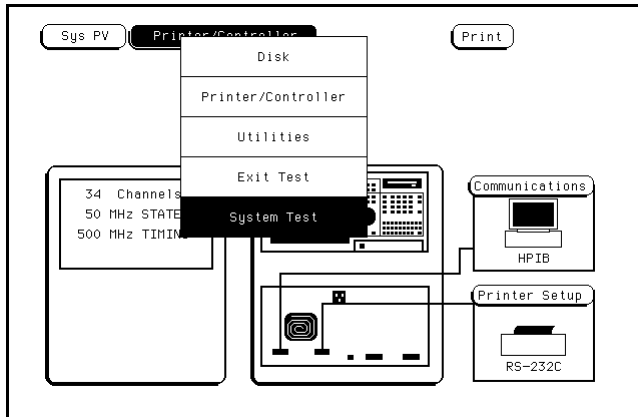

- 8 Install a formatted disk that is not write protected into the disk drive. If the 1664A has the RS-232C option (020), connect an RS-232C loopback connector onto the RS-232C port.
- 9 Select All System Tests.

You can run all tests at one time, except for the Front Panel Test and Display Test, by running All System Tests. To see more details about each test when troubleshooting failures, you can run each test individually. This example shows how to run all tests at once.

When the tests finish, the status for each test shows Passed or Failed, and the status for the All System Tests changes from Untested to Tested. Note that the Front Panel Test and Display Test remain Untested, and the RS-232C Test will display FAILED if option 020 is not installed.

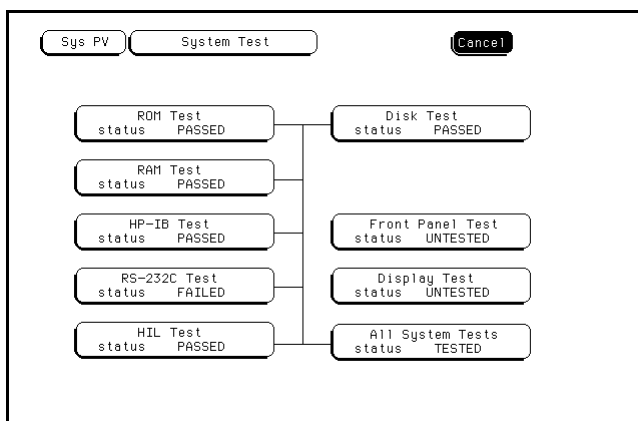

- 10 Select the Front Panel Test.

A screen duplicating the front panel appears on the screen.

- a Press each key on the front panel. The corresponding key on the screen will change from a light to a dark color. Test the knob by turning it in both directions.
- b Note any failures, then press the Done key a second time to exit the Front Panel Test. The status of the test changes from Untested to Tested.

**11 Select the Display Test.**

A white grid pattern is displayed. These display screens are not normally used, but can be used to adjust the display. Refer to chapter 4, "Calibrating and Adjusting" for display adjustments.

- a** Select Continue and the screen changes to full bright.
- b** Select Continue and the screen changes to half bright.
- c** Select Continue and the test screen shows the Display Test status changed to Tested.

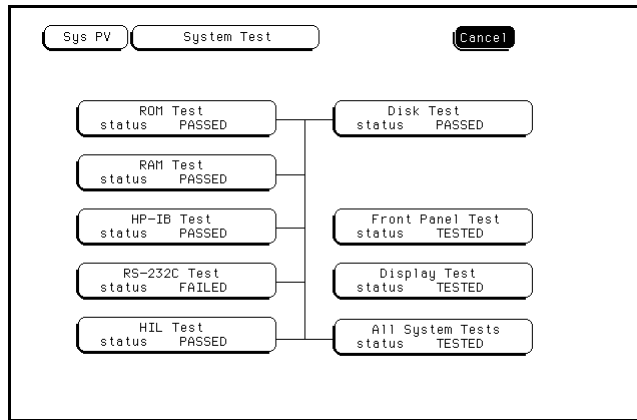

- 12** Record the results of the tests on the performance test record at the end of this chapter.
- 13** To exit the test system, press the System key, then select Exit Test in the pop-up menu and press the Select key. Reinstall the disk containing the operating system, then select Exit Test System and press the Select key.

# To make the test connectors

The test connectors connect the logic analyzer to the test equipment.

## Materials Required

Description	Recommended Part	Qty
BNC (f) Connector	Agilent 1250-1032	5
100 $\Omega$ 1% resistor	Agilent 0698-7212	8
Berg Strip, 17-by-2		1
Berg Strip, 6-by-2		4
20:1 Probe	Agilent 54006A	2
Jumper wire		

- 1 Build four test connectors using BNC connectors and 6-by-2 sections of Berg strip.
  - a Solder a jumper wire to all pins on one side of the Berg strip.
  - b Solder a jumper wire to all pins on the other side of the Berg strip.
  - c Solder two resistors to the Berg strip, one at each end between the end pins.
  - d Solder the center of the BNC connector to the center pin of one row on the Berg strip.
  - e Solder the ground tab of the BNC connector to the center pin of the other row on the Berg strip.
  - f On two of the test connectors, solder a 20:1 probe. The probe ground goes to the same row of pins on the test connector as the BNC ground tab.

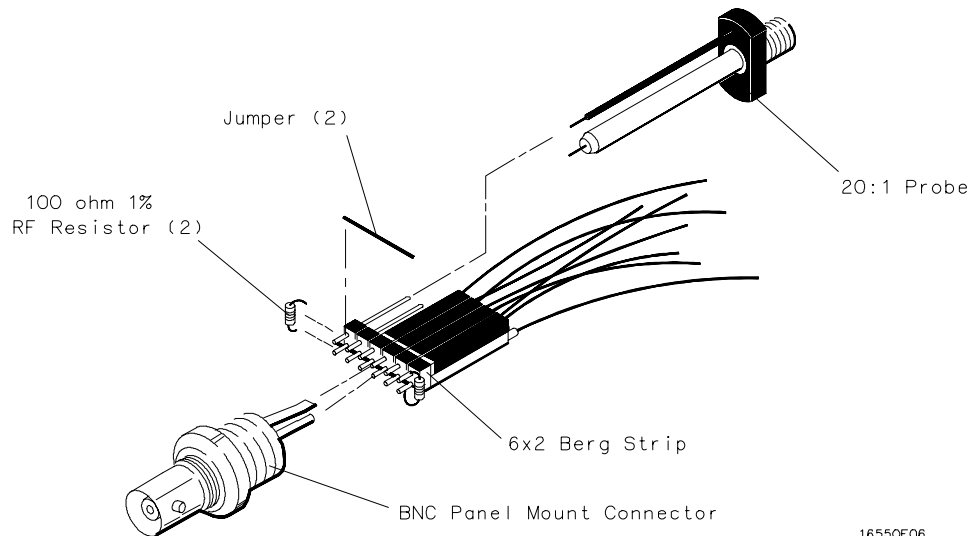

- 2** Build one test connector using a BNC connector and a 17-by-2 section of Berg strip.
  - a** Solder a jumper wire to all pins on one side of the Berg strip.
  - b** Solder a jumper wire to all pins on the other side of the Berg strip.
  - c** Solder the center of the BNC connector to the center pin of one row on the Berg strip.
  - d** Solder the ground tab of the BNC connector to the center pin of the other row on the Berg strip.

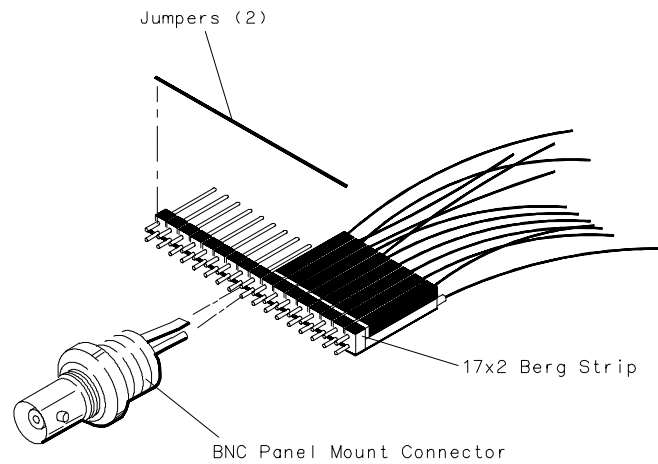

16550E05

---

## To test the threshold accuracy

Testing the threshold accuracy verifies the performance of the following specification:

- **Clock and data channel threshold accuracy.**

These instructions include detailed steps for testing the threshold settings of pod 1. After testing pod 1, connect and test pod 2. To test pod 2, follow the detailed steps for pod 1, substituting the pod 2 for pod 1 in the instructions.

Each threshold test tells you to record the voltage reading in the performance test record located at the end of this chapter. To check if each test passed, verify that the voltage reading you record is within the limits listed on the performance test record.

---

### Equipment Required

Equipment	Critical Specifications	Recommended Model/Part
Digital Multimeter	0.1 mV resolution, 0.005% accuracy	Agilent 3458A
Function Generator	DC offset voltage $\pm 6.3$ V	Agilent 3325B Option 002
BNC-Banana Cable		Agilent 11001-60001
BNC Tee		Agilent 1250-0781
BNC Cable		Agilent 8120-1840
BNC Test Connector, 17x2		

---

### Set up the equipment

- 1 Turn on the equipment required and the logic analyzer. Let them warm up for 30 minutes before beginning the test.
- 2 Set up the function generator.
  - a Set up the function generator to provide a DC offset voltage at the Main Signal output.
  - b Disable any AC voltage to the function generator output, and enable the high voltage output.
  - c Monitor the function generator DC output voltage with the multimeter.

---

## Set up the logic analyzer

- 1 Press the Config key. Assign all pod fields to Machine 1. To assign the pod fields, select the pod fields, then select Machine 1 in the pop-up menu.
- 2 In the Analyzer 1 box, select the Type field. Select Timing in the pop-up menu.

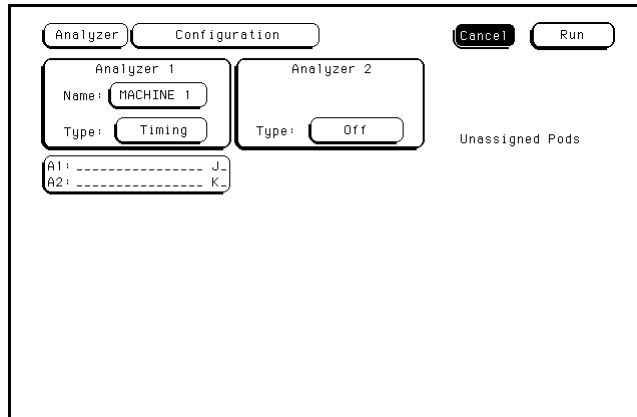

---

## Connect the logic analyzer

- 1 Using the 17-by-2 test connector, BNC cable, and probe tip assembly, connect the data and clock channels of pod 1 to one side of the BNC Tee.
- 2 Using a BNC-banana cable, connect the voltmeter to the other side of the BNC Tee.
- 3 Connect the BNC Tee to the Main Signal output of the function generator.

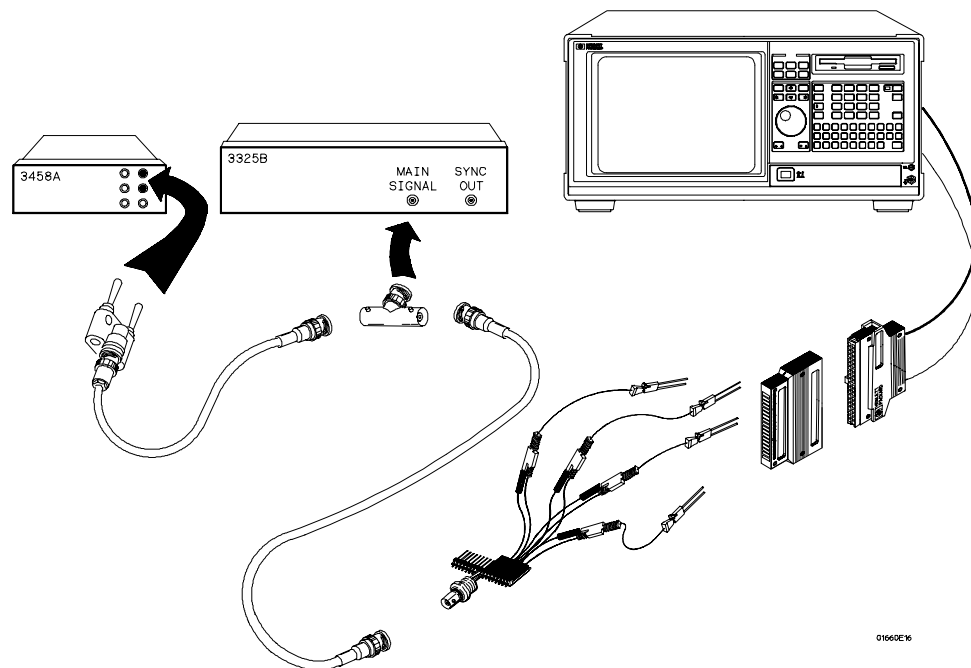

## Test the TTL threshold

- 1 Press the Format key. Select the field to the right of Pod 1, then select TTL in the pop-up menu.
- 2 On the function generator front panel, enter 1.647 V  $\pm$ 1 mV DC offset. Use the multimeter to verify the voltage.

The activity indicators for pod 1 should show all data channels and the J-clock channel at a logic high.

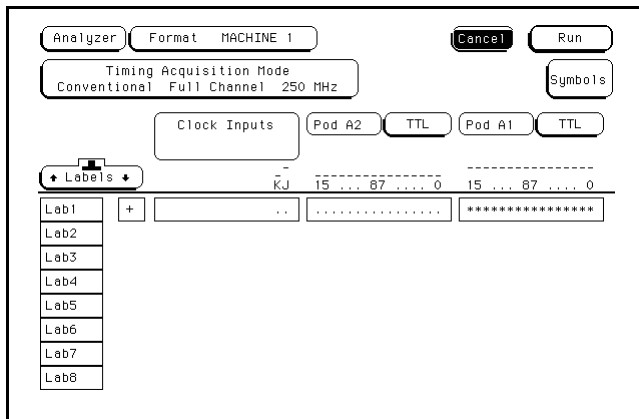

- 3 Using the Modify down arrow on the function generator, decrease offset voltage in 1-mV increments until all activity indicators for pod 1 show the channels at a logic low. Record the function generator voltage in the performance test record.

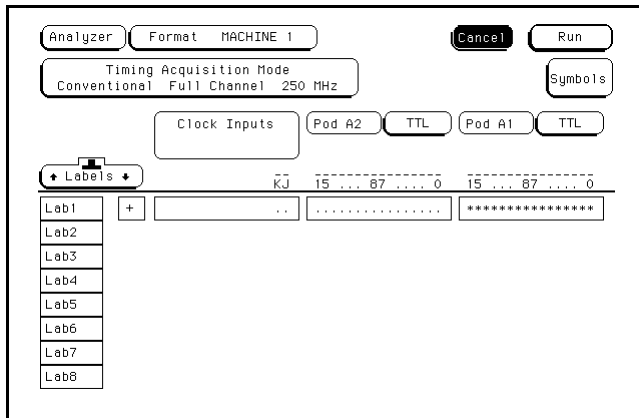



- Using the Modify up arrow on the function generator, increase offset voltage in 1-mV increments until all activity indicators for pod 1 show the channels at a logic high. Record the function generator voltage in the performance test record.

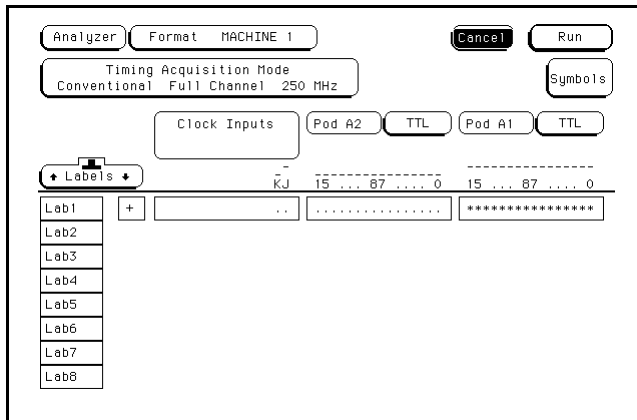

## Test the ECL threshold

- 1 Select the field to the right of Pod 1, then select ECL in the pop-up menu.
- 2 On the function generator front panel, enter  $-1.160\text{ V} \pm 1\text{ mV}$  DC offset. Use the multimeter to verify the voltage.  
The activity indicators for pod 1 should show all data channels and the J-clock channel at a logic high.
- 3 Using the Modify down arrow on the function generator, decrease offset voltage in 1-mV increments until all activity indicators for pod 1 show the channels are at a logic low. Record the function generator voltage in the performance test record.

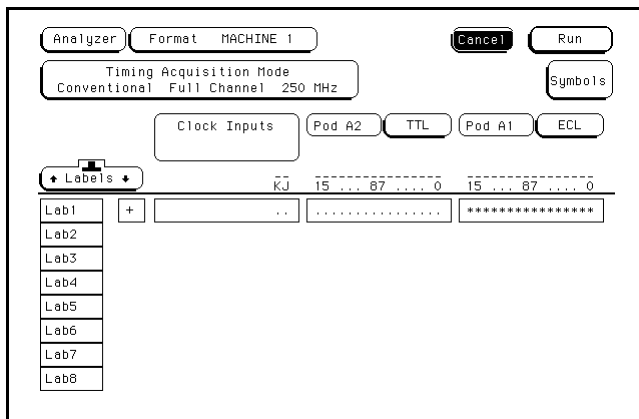

- 4 Using the Modify up arrow on the function generator, increase offset voltage in 1-mV increments until all activity indicators for pod 1 show the channels are at a logic high. Record the function generator voltage in the performance test record.

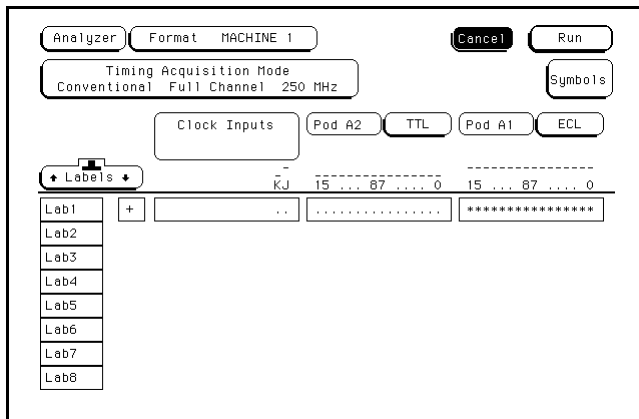

## Test the – User threshold

- 1 Move the cursor to the field to the right of Pod 1. Type  $-6.00$ , then use the left and right cursor control keys to highlight V. Press the Select key.
- 2 On the function generator front panel, enter  $-5.718\text{ V} \pm 1\text{ mV}$  DC offset. Use the multimeter to verify the voltage.

The activity indicators for pod 1 should show all data channels and the J-clock channel at a logic high.

- 3 Using the Modify down arrow on the function generator, decrease offset voltage in 1-mV increments until all activity indicators for pod 1 show the channels at a logic low. Record the function generator voltage in the performance test record.

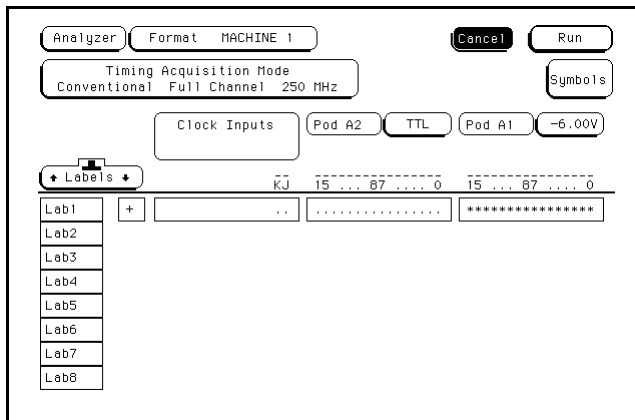

- 4 Using the Modify up arrow on the function generator, increase offset voltage in 1-mV increments until all activity indicators show the channels at a logic high. Record the function generator voltage in the performance test record.

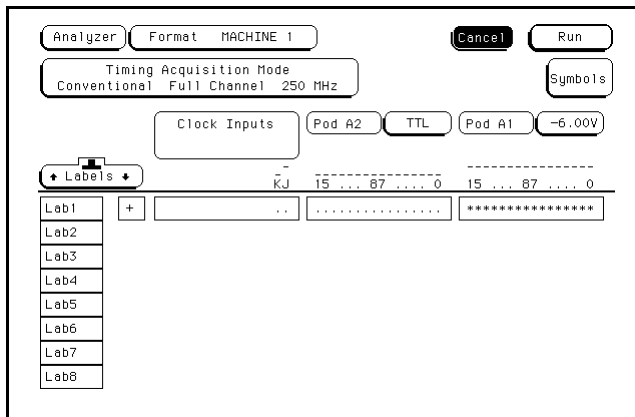

## Test the + User threshold

- 1 Move the cursor to the field to the right of Pod 1. Type +6.00, then use the left and right cursor control keys to highlight V. Press the Select key.
- 2 On the function generator front panel, enter +6.282 V  $\pm$ 1 mV DC offset. Use the multimeter to verify the voltage.

The activity indicators for pod 1 should show all data channels and the J-clock channel at a logic high.

- 3 Using the Modify down arrow on the function generator, decrease offset voltage in 1-mV increments until all activity indicators for pod 1 show the channels at a logic low. Record the function generator voltage in the performance test record.

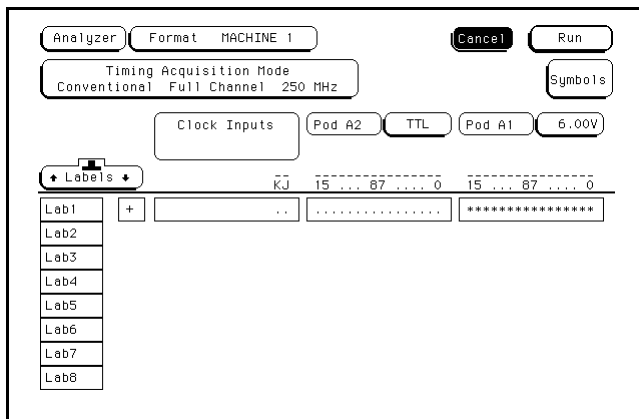

- 4 Using the Modify up arrow on the function generator, increase offset voltage in 1-mV increments until all activity indicators for pod 1 show the channels at a logic high. Record the function generator voltage in the performance test record.

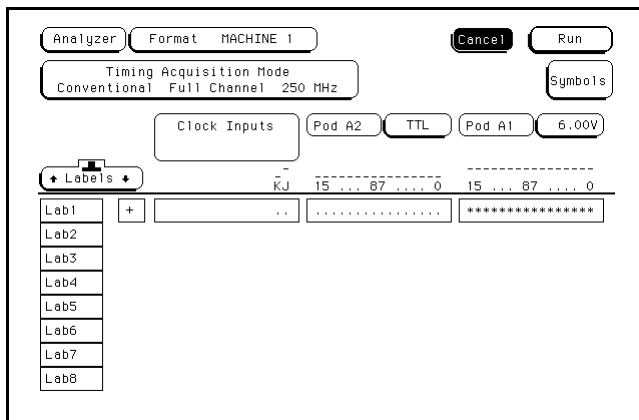

## Test the 0 V User threshold

- 1 Move the cursor to the field to the right of Pod 1. Type 0, then press the Select key.
- 2 On the function generator front panel, enter +0.102 V  $\pm$ 1 mV DC offset. Use the multimeter to verify the voltage.

The activity indicators for pod 1 should show all data channels and the J-clock channel at a logic high.

- 3 Using the Modify down arrow on the function generator, decrease offset voltage in 1-mV increments until all activity indicators for pod 1 show the channels at a logic low. Record the function generator voltage in the performance test record.

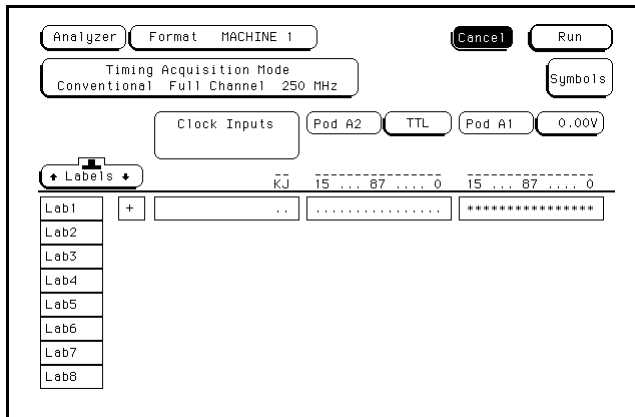

- 4 Using the Modify up arrow on the function generator, increase offset voltage in 1-mV increments until all activity indicators for pod 1 show the channels at a logic high. Record the function generator voltage in the performance test record.

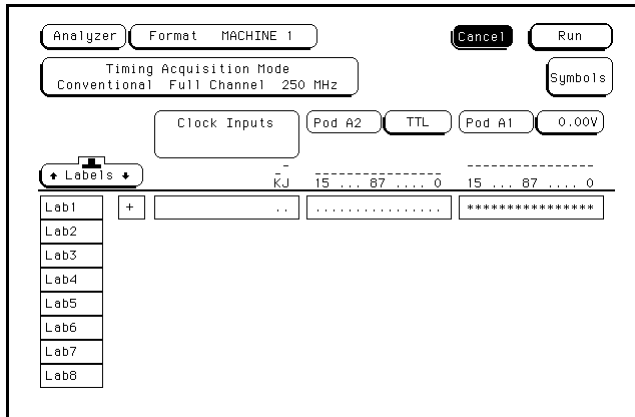

### Test the next pod

- 1 Using the 17-by-2 test connector and probe tip assembly, connect the data and clock channels of pod 2 to the output of the function generator.
- 2 Start with "Test the TTL threshold" on page 3-10, substituting pod 2 for pod 1.

---

## To test the glitch capture

Testing the glitch capture verifies the performance of the following specification:

- **Minimum detectable glitch.**

This test checks the minimum detectable glitch on sixteen data channels at a time.

---

### Equipment Required

Equipment	Critical Specifications	Recommended Model/Part
Pulse Generator	100 MHz 3.5 ns pulse width, < 600 ps rise time	Agilent 8131A Option 020
Digitizing Oscilloscope	≥ 6 GHz bandwidth, < 58 ps rise time	Agilent 54121T
SMA Coax (Qty 3)	18 GHz bandwidth	Agilent 8120-4948
Adapter (Qty 4)	SMA(m)-BNC(f)	Agilent 1250-1200
Coupler (Qty 4)	BNC (m)(m)	Agilent 1250-0216
BNC Test Connector, 6x2 (Qty 4)		

---

### Set up the equipment

- 1 Turn on the equipment required and the logic analyzer. Let them warm up for 30 minutes before beginning the test if you have not already done so.
- 2 Set up the pulse generator.

---

### Pulse Generator Setup

Channel 1	Channel 2	Period
Delay: 0 ps	Delay: 0 ps	22.0 ns
Width: 3.5 ns	Width: 3.5 ns	
High: -0.9 V	High: -0.9 V	
Low: -1.7 V	Low: -1.7 V	

### 3 Set up the oscilloscope.

#### Oscilloscope Setup

Time Base	Display	Delta V	Delta T
Time/Div: 1.00 ns/div	mode: avg	V markers on	T markers on
delay: 17.7000 ns	# of avg: 16	marker 1 position: Chan 1	start on: Pos Edge 1
	screens: dual	marker 2 position: Chan 2	stop on: Pos Edge 1

Channel	Channel 1	Channel 2
<b>Display</b>	on	on
<b>Probe Atten</b>	20.00	20.00
<b>Volts/Div</b>	400 mV	400 mV
<b>Offset</b>	-1.3000 V	-1.3000 V

### Set up the logic analyzer

- 1 Press the Config key. Assign all pod fields to Machine 1. To assign the pod fields, select the pod fields, then select Machine 1 in the pop-up menu.
- 2 In the Analyzer 1 box, select the Type field. Select Timing in the pop-up menu.

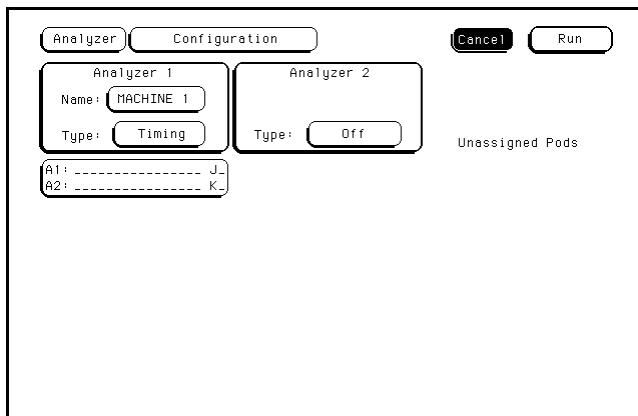

### Connect the logic analyzer

- 1 Using SMA cables, connect the oscilloscope to the pulse generator channel 1 Output, channel 2 Output, and Trig Output.
- 2 Using the 6-by-2 test connectors, connect the first combination of logic analyzer clock and data channels listed in the table to the pulse generator.  
You will repeat this test for the remaining combinations.



**Connect the Logic Analyzer to the Pulse Generator**

Testing Combinations	To Agilent 8131A Channel 1 Output	To 8131A Channel 1 Output	To 8131A Channel 2 Output	To 8131A Channel 2 Output
1	Pod 1 ch 0, 2, 4, 6, J-clock	Pod 1 ch 1, 3, 5, 7	Pod 1 ch 8, 10, 12, 14	Pod 1 ch 9, 11, 13, 15
2	Pod 2 ch 0, 2, 4, 6, K-clock	Pod 2 ch 1, 3, 5, 7	Pod 2 ch 8, 10, 12, 14	Pod 2 ch 9, 11, 13, 15

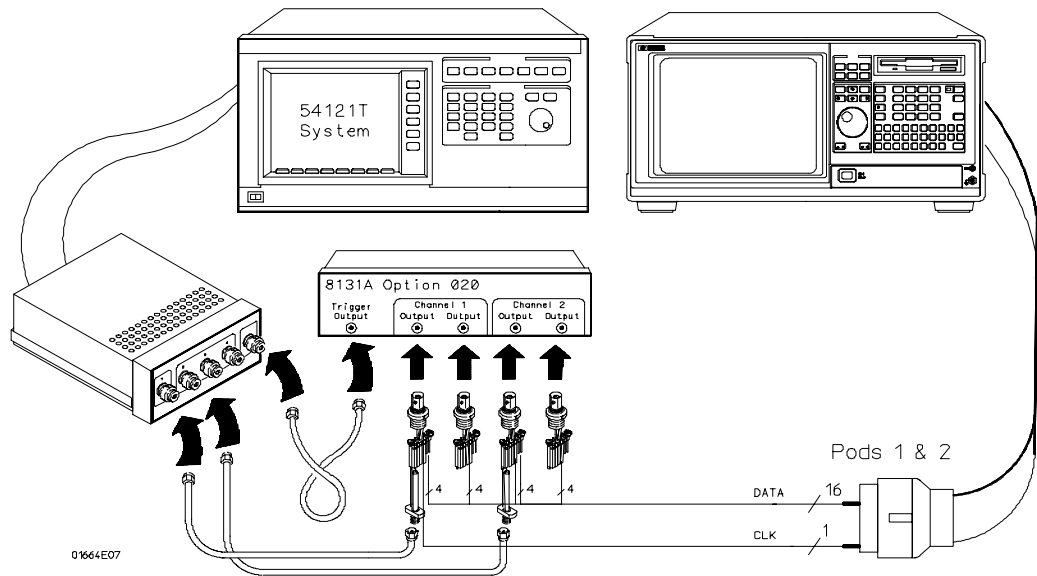

## Test the glitch capture on the connected channels

### 1 Set up the Format menu.

- a Press the Format key.
- b Select the field to the right of the pod, then select ECL in the pop-up menu. Use the arrow keys to access pods not shown on the screen (select the Pods field and push Select).
- c Select Timing Acquisition Mode, then select Glitch Half Channel 125 MHz.

### 2 Turn on the channels that correspond to the channels being tested.

The channels being tested are the channels connected to the pulse generator in "Connect the logic analyzer."

- a Select the pod field, then select one of the two pods in the pop-up. Move the cursor to the channel assignment field of the pod and press the Clear entry key until all channels of the pod are assigned (all asterisks). Press the Done key.
- b Turn on the clock/data channels that correspond to the clocks being tested. Turn off the data channels and clock/data channels that are not being tested.

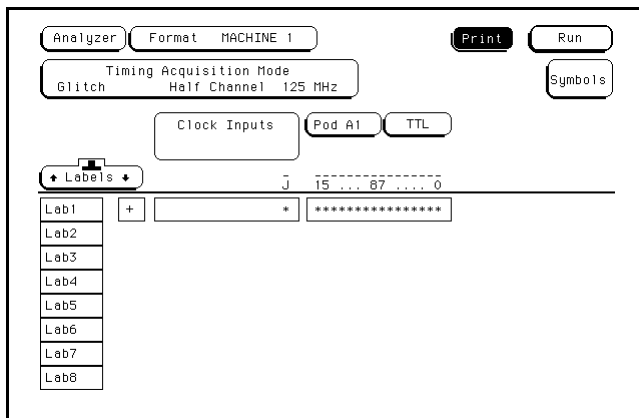

**3** Set up the Trigger menu.

- a** Press the Trigger key.
- b** Select Modify Trigger, then Clear Trigger, then select All in the pop-up menus.

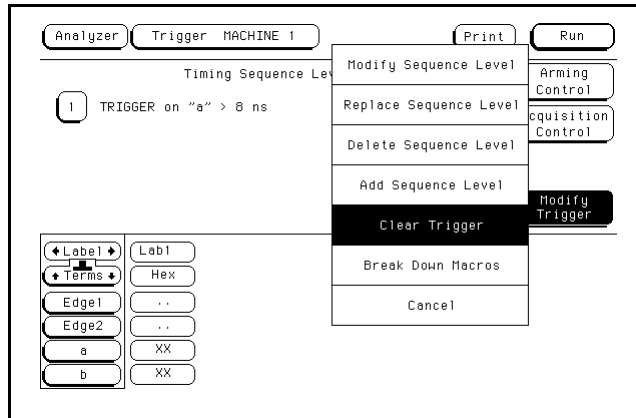

- 4** Using the Precision Edge Find in the Delta T menu of the oscilloscope, verify that the pulse widths of the pulse generator channels 1 and 2 are 3.450 ns, +50 ps or -100 ps. If necessary, adjust the pulse widths of the pulse generator channels 1 and 2.

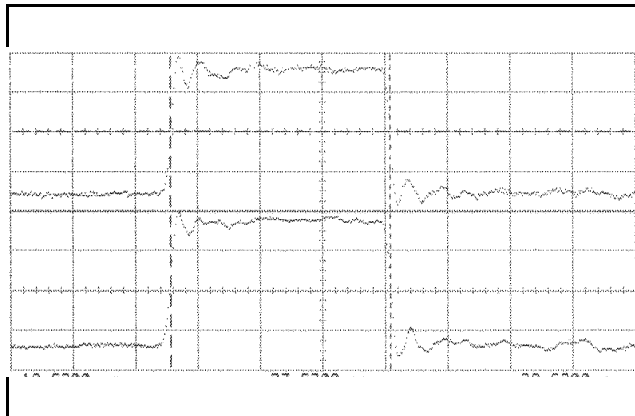

**5** Set up the Waveform menu to view all the channels.

- a** Select one of the Glitch labels, then select Delete All in the pop-up menu.
- b** Select All, then select continue.
- c** Press the Select key, then select Insert in the pop-up menu.
- d** Press the Select key, then select Sequential in the pop-up menu.

Testing Performance  
To test the glitch capture

- 6 On the logic analyzer, press the Run key. The display should be similar to the figure below.

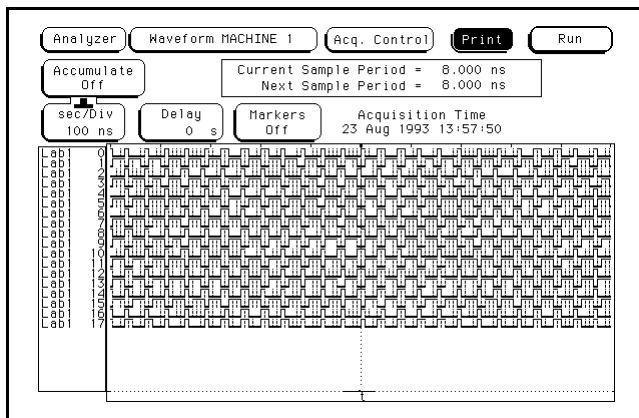

- 7 On the pulse generator, enable Channel 1 and Channel 2 COMP (with the LED on).  
8 On the logic analyzer, press the Run key. The display should be similar to the figure below. Record Pass or Fail in the performance test record.

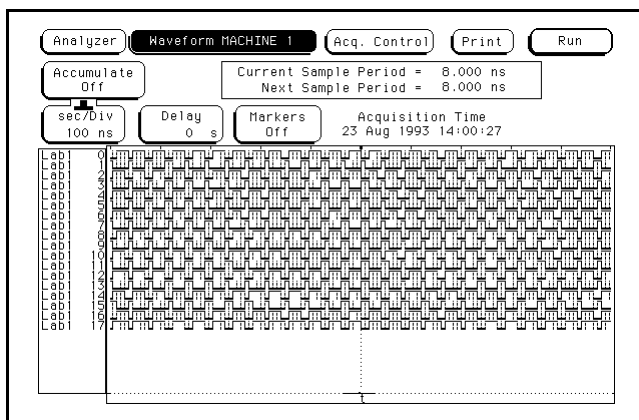

---

### Test the next channels

- Return to "Connect the logic analyzer" on page 3-18 and connect and test the next combination of data and clock channels until all pods are tested.  
To access pod 2 in the Format menu, select pod 1 field, then select pod 2 in the pop-up menu.

---

# To test the single-clock, single-edge, state acquisition

Testing the single-clock, single-edge, state acquisition verifies the performance of the following specifications:

- Minimum master to master clock time.
- Maximum state acquisition speed.
- Setup/Hold time for single-clock, single-edge, state acquisition.
- Minimum clock pulse width.

This test checks the data channels using a single-edge clock at three selected setup/hold times.

---

## Equipment Required

Equipment	Critical Specifications	Recommended Model/Part
Pulse Generator	100 MHz 3.5 ns pulse width, < 600 ps rise time	Agilent 8131A option 020
Digitizing Oscilloscope	≥ 6 GHz bandwidth, < 58 ps rise time	Agilent 54121T
Adapter	SMA(m)-BNC(f)	Agilent 1250-1200
SMA Coax Cable (Qty 3)	18 GHz bandwidth	Agilent 8120-4948
BNC Cable	BNC(m)(m) 48 in. >2 GHz bandwidth	Agilent 8120-1840
Coupler	BNC(m)(m)	Agilent 1250-0216
BNC Test Connector, 6x2 (Qty 4)		

---

## Set up the equipment

- 1 Turn on the equipment required and the logic analyzer. Let them warm up for 30 minutes before beginning the test if you have not already done so.
- 2 Set up the pulse generator.
  - a Set up the pulse generator according to the following table.

---

### Pulse Generator Setup

Channel 1	Channel 2	Period
Delay: 0 ps	Doub: 20.0 ns	40 ns
Width: 3.5 ns	Width: 3.5 ns	
High: -0.9 V	High: -0.9 V	
Low: -1.7 V	Low: -1.7 V	

- b Disable the pulse generator channel 2 COMP (with the LED off).

**3 Set up the oscilloscope.**

**Oscilloscope Setup**

Time Base	Display	Delta V	Delta T
Time/Div: 1.00 ns/div	avg # of avg: 16 screen: dual	V markers on marker 1 position: Chan 1 marker 2 position: Chan 1	T markers on start on: Pos Edge 1 stop on: Neg Edge 1
Channel			
	Channel 1	Channel 2	
<b>Display</b>	on	on	
<b>Probe Atten</b>	20.00	20.00	
<b>Offset</b>	-1.3 V	-1.3 V	
<b>Volts/Div</b>	400 mV	400 mV	

**Set up the logic analyzer**

**1 Set up the Configuration menu.**

- a** Press the Config key.
- b** In the Configuration menu, assign all pods to Machine 1. To assign the pods, select the pod fields, then select Machine 1 in the pop-up menu.
- c** Select the Type field in the Analyzer 1 box, then select State.

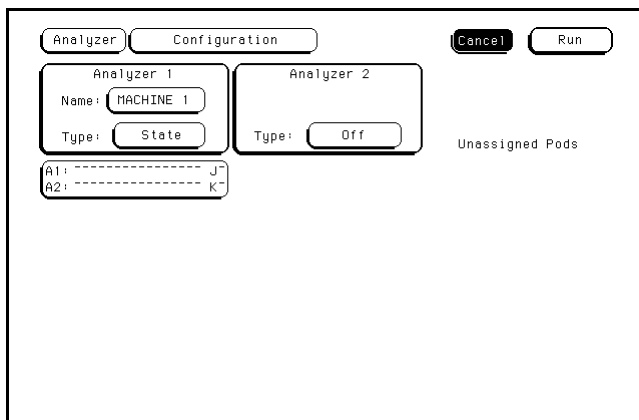

**2 Set up the Format menu.**

- a** Press the Format key. Select State Acquisition Mode, then select Full Channel/4K Memory/50MHz.
- b** Select the field to the right of each pod, then select ECL in the pop-up menu.

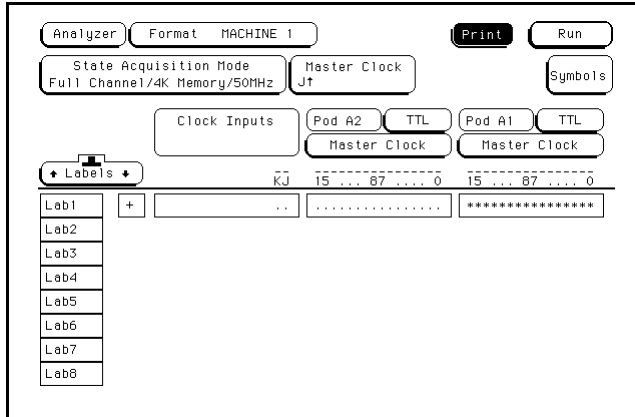

**3 Set up the Trigger menu.**

- a** Press the Trigger key. Select Modify Trigger, then Clear Trigger, then select All in the pop-up menus.
- b** Select Count Off. Press Select again, then select Time in the pop-up menu. Select Done to exit the menu.
- c** Select the field labeled 1 under the State Sequence Levels. Select the field labeled "anystate," then select "no state." Select Done to exit the State Sequence Levels menu.
- d** Select the field next to "a," under the label Lab1. Type "000A", then press the Select key.

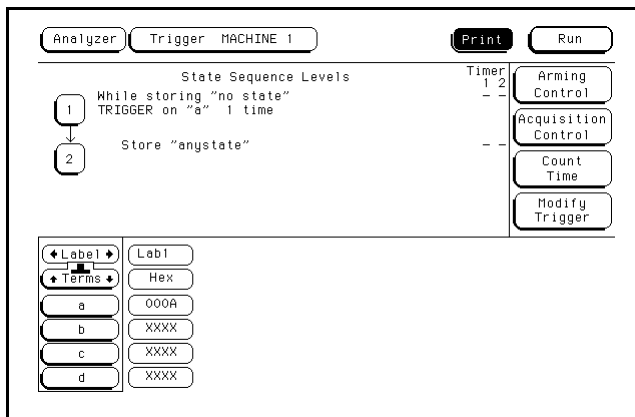

## Connect the logic analyzer

- 1 Using the 6-by-2 test connectors, connect the logic analyzer clock and data channels listed in the following table to the pulse generator. Install a BNC cable between the pulse generator channel 2 output and the 6x2 test connector with the logic analyzer clock leads.
- 2 Using SMA cables, connect the oscilloscope to the pulse generator channel 1 Output, channel 2 Output, and Trig Output.

### Connect the 1664A Logic Analyzer to the Pulse Generator

Testing Combination	Connect to Agilent 8131A Channel 1 Output	Connect to Agilent 8131A Channel 1 Output	Connect to Agilent 8131A Channel 2 Output
1	Pod 1, channel 3 Pod 2, channel 3	Pod 1, channel 11 Pod 2, channel 11	J-clock

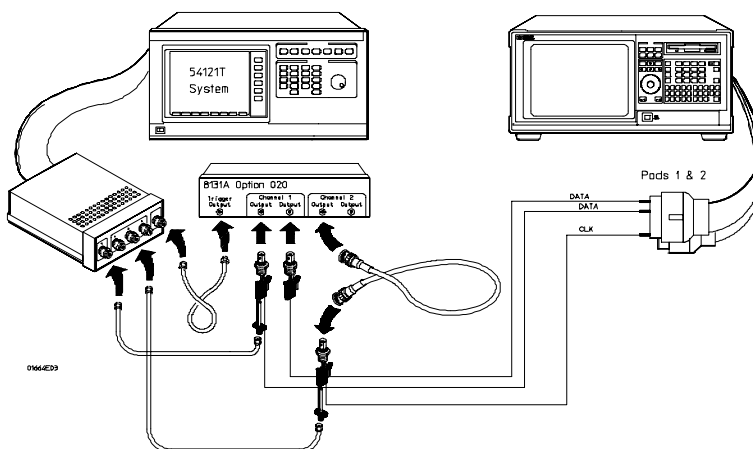

- 3 Activate the data channels that are connected according to the previous table.
  - a Press the Format key.
  - b Select the field showing the channel assignments for one of the pods being tested, then press the Clear entry key. Using the arrow keys, move the selector to the data channels to be tested, then press the Select key. An asterisk means that a channel is turned on. When all the correct channels of the pod are turned on, press the Done key. Follow this step for the remaining pods.

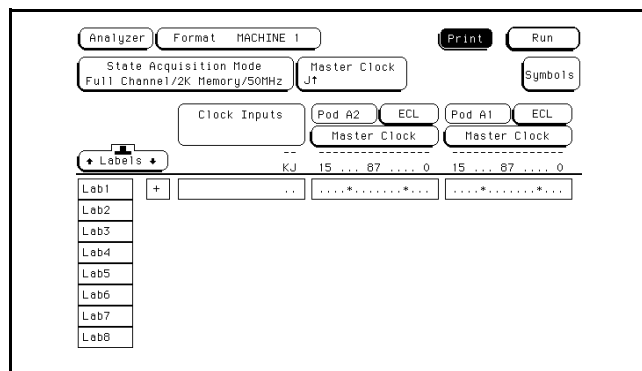



- c Press the Trigger key. Make sure pattern term **a** is "A". If not, select the field next to "a" under the label Lab1. Type "A", then press the Select key.

---

## Verify the test signal

- 1 Check the clock pulse width. Using the oscilloscope, verify that the clock pulse width is 3.50 ns, +0 ps or -100 ps.
  - a Enable the pulse generator channel 1 and channel 2 outputs.
  - b In the oscilloscope Timebase menu, select Delay. Using the oscilloscope knob, position the clock waveform so that the waveform is centered on the screen.
  - c In the oscilloscope Delta V menu, set the Marker 1 Position to Chan 2, then set Marker 1 at -1.3000 V. Set Marker 2 Position to Chan 2, then set Marker 2 at -1.3000 V.
  - d In the oscilloscope Delta T menu, select Start On Pos Edge 1. Select Stop on Neg Edge 1.
  - e If the pulse width is outside the limits, adjust the pulse generator channel 2 width and select the oscilloscope Precision Edge Find until the pulse width is within limits.

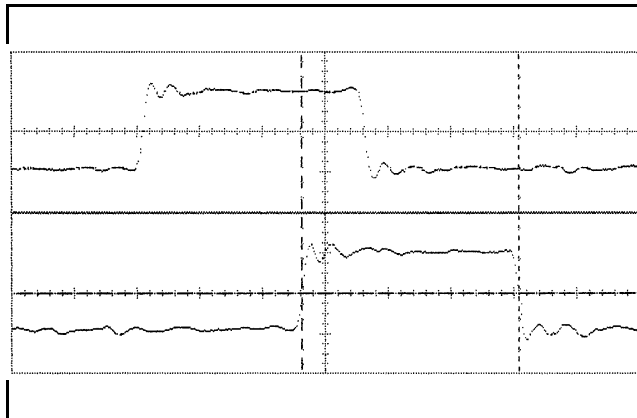

- 2 Check the clock period. Using the oscilloscope, verify that the clock period is 20 ns, +0 ps or -250 ps.
  - a In the oscilloscope Timebase menu, select Sweep Speed 4.00 ns/div.
  - b Select Delay. Using the oscilloscope knob, position the clock waveform so that a rising edge appears at the left of the display.

**To test the single-clock, single-edge, state acquisition**

- c In the oscilloscope Measure menu, select Measure Chan 2, then select Period. If the period is more than or equal to 20.000 ns, go to step 4. If the period is less than 20.000 ns but greater than 19.75 ns, go to step 3.
- d In the oscilloscope Timebase menu, add 10 ns to the delay.
- e In the oscilloscope Measure menu, select Period. If the period is more than or equal to 20.000 ns, decrease the pulse generator Chan 2 Doub in 100-ps increments until one of the two periods measured is less than 20.000 ns but greater than 19.75 ns.

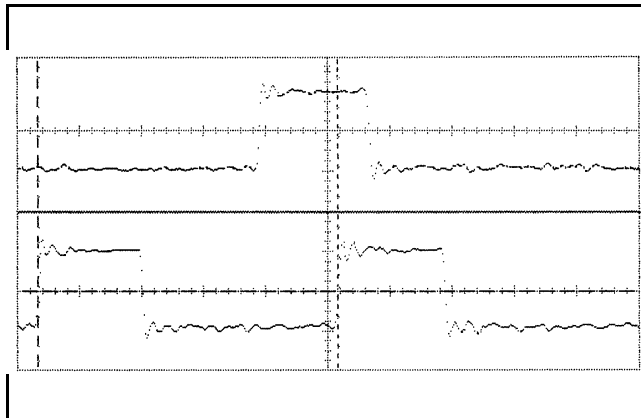

- 3 Check the data pulse width. Using the oscilloscope, verify that the data pulse width is 3.50 ns, +0 ps or -100 ps.
  - a Enable the pulse generator channel 1 and channel 2 outputs. Leave channel 2 output disabled.
  - b In the oscilloscope Timebase menu, select Sweep Speed 1.00 ns/div.
  - c Select Delay. Using the oscilloscope knob, position the data waveform so that the waveform is centered on the screen.
  - d In the oscilloscope Delta V menu, set the Marker 1 Position to Chan 1, then set Marker 1 at -1.3000 V. Set the Marker 2 Position to Chan 1, then set Marker 2 at -1.3000 V.
  - e In the oscilloscope Delta T menu, select Start On Pos Edge 1. Select Stop on Neg Edge 1.
  - f Select Precision Edge Find.
  - g If the pulse width is outside the limits, adjust the pulse generator channel 1 width and select the oscilloscope Precision Edge Find until the pulse width is within limits.

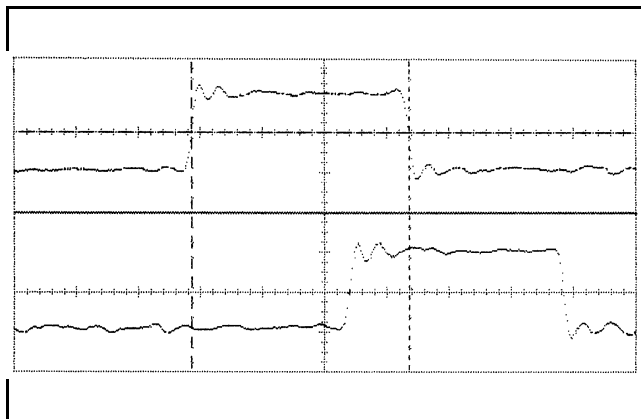

## Check the setup/hold combination

- 1 Select the logic analyzer setup/hold time.
  - a In the logic analyzer Format menu, select Master Clock.
  - b Select the Setup/Hold field, then select the setup/hold combination to be tested for all pods. The first time through this test, use the top combination in the following table.

### Setup/Hold Combinations

3.5/0.0 ns

0.0/3.5 ns

1.5/2.0 ns

- c Select Done to exit the setup/hold combinations.

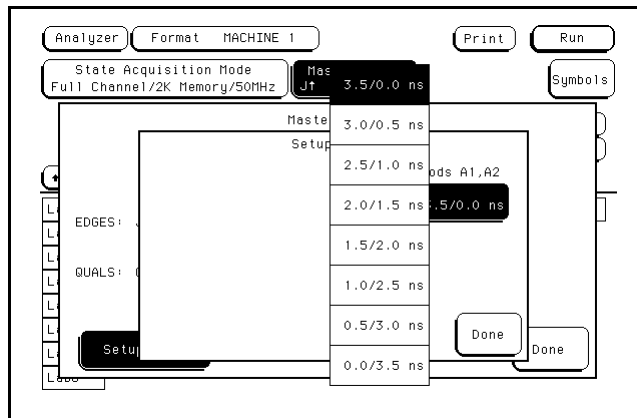

- 2 Disable the pulse generator channel 2 COMP (with the LED off).
- 3 Using the Delay mode of the pulse generator channel 1, position the pulses according to the setup time of the setup/hold combination selected, +0.0 ps or -100 ps.
  - a In the oscilloscope Delta V menu, set the Marker 1 Position to Chan 1, then set Marker 1 at -1.3000 V. Set the Marker 2 Position to Chan 2, then set Marker 2 at -1.3000 V.
  - b In the oscilloscope Delta T menu, select Start on Pos Edge 1. Select Stop on Pos Edge 1.

Testing Performance  
To test the single-clock, single-edge, state acquisition

- c Adjust the pulse generator channel 1 Delay, then select Precision Edge Find in the oscilloscope Delta T menu. Repeat this step until the pulses are aligned according to the setup time of the setup/hold combination selected, +0.0 ps or -100 ps.

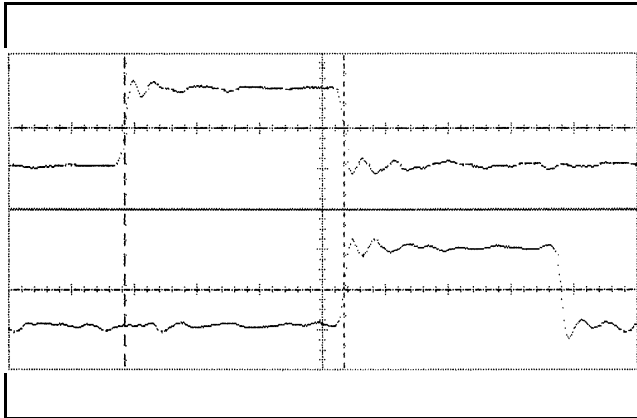

- 4 Select the clock to be tested.
  - a In the Master Clock menu, select the clock field to be tested, then select the clock edge as indicated in the table. The first time through this test, use the top clock and edge in the following table.

**Clocks**

J↑

K↑

- b Connect the clock to be tested to the pulse generator channel 2 output.
- c Select Done to exit the Master Clock menu.

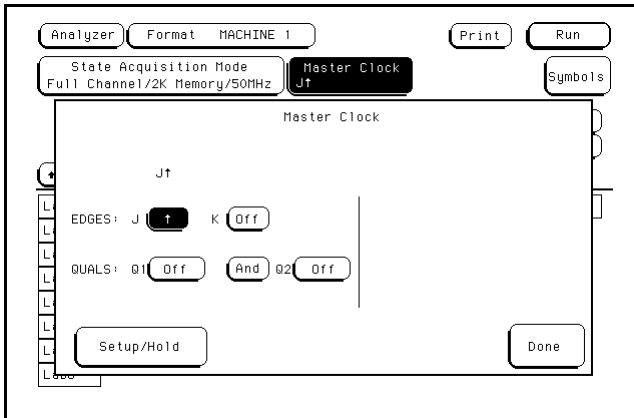

- 5 Note: This step is only done the first time through the test, to create a Compare file. For subsequent runs, go to step 6. Use the following to create a Compare file:
- Press Run. The display should show a checkerboard pattern of alternating As and 5s. Verify the pattern by scrolling through the display.
  - Press the List key. In the pop up menu, use the RPG knob to move the cursor to Compare. Press Select.
  - In the Compare menu, move the cursor to Copy Listing to Reference, then select Execute in the pop-up menu and press the Select key.
  - Move the cursor to Specify Stop Measurement and press the Select key. Press Select again to turn on Compare. At the pop up menu, select Compare. Move the cursor to the Equal field and press the Select key. At the pop up menu, select Not Equal. Press Done.
  - Move the cursor to the Reference Listing field and select. The field should toggle to Difference Listing.

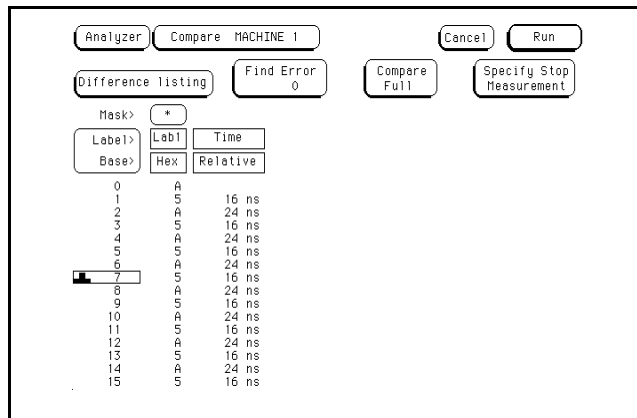

- Press the blue shift key, then press the Run key. If 2 - 4 acquisitions are obtained without the "Stop Condition Satisfied" message appearing, then the test passes. Press Stop to halt the acquisition. Record the Pass or Fail results in the performance test record.
- Test the next clock.
  - Press the Format key, then select Master Clock.
  - Turn off and disconnect the clock just tested.
  - Repeat steps 4, 6, and 7 for the next clock edge listed in the table in step 4, until all listed clock edges have been tested.
- Enable the pulse generator channel 2 COMP (with the LED on).
- Check the clock pulse width.
  - Enable the pulse generator channel 1 and channel 2 outputs.
  - In the oscilloscope Timebase menu, select Delay. Using the oscilloscope knob, position the clock waveform so that the waveform is centered on the screen.
  - In the oscilloscope Delta V menu, set the Marker 1 Position to Chan 2, then set Marker 1 at -1.3000 V. Set the Marker 2 Position to Chan 2, then set Marker 2 at -1.3000 V.
  - In the oscilloscope Delta T menu, select Start On Neg Edge 1. Select Stop on Pos Edge 1.
  - If the pulse width is outside the limits, adjust the pulse generator channel 2 width and select the oscilloscope Precision Edge Find until the pulse width is within limits.

- 10 Using the Delay mode of the pulse generator channel 1, position the pulses according to the setup/hold combination selected, +0.0 ps or -100 ps.
  - a In the oscilloscope Delta V menu, set the Marker 1 Position to Chan 1, then set Marker 1 at -1.3000 V. Set the Marker 2 Position to Chan 2, then set Marker 2 at -1.3000 V.
  - b In the oscilloscope Delta T menu, select Start on Pos Edge 1. Select Stop on Neg Edge 1.
  - c Adjust the pulse generator channel 1 Delay, then select Precision Edge Find in the oscilloscope Delta T menu. Repeat this step until the pulses are aligned according to the setup time of the setup/hold combination selected.

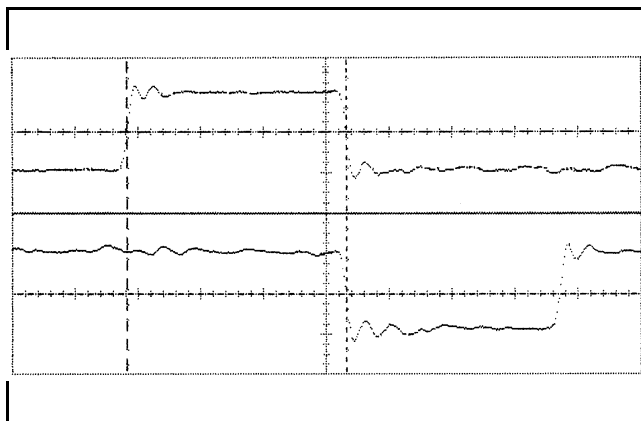

- 11 Select the clock to be tested.
  - a In the Master Clock menu, select the clock field to be tested, then select the clock edge as indicated in the table. The first time through this test, use the top clock and edge.

---

**Clocks**

---

J↓

K↓

- b Connect the clock to be tested to the pulse generator channel 2 output.
- c Select Done to exit the Master Clock menu (see illustration).

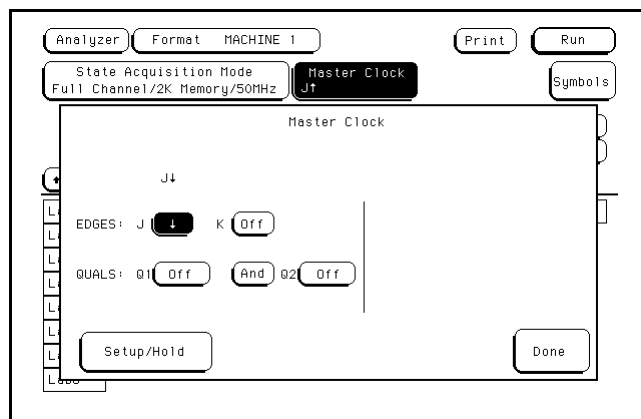

- 12** Press the blue shift key, then press the Run key. If 2 - 4 acquisitions are obtained without the "Stop Condition Satisfied" message appearing, then the test passes. Press Stop to halt the acquisition. Record the Pass or Fail results in the performance test record.
- 13** Test the next clock.
  - a** Press the Format key, then select Master Clock.
  - b** Turn off and disconnect the clock just tested.
  - c** Repeat steps 11, 12, and 13 for the next clock edge listed in the table in step 10, until all listed clock edges have been tested.
- 14** Test the next setup/hold combination.
  - a** In the logic analyzer Format menu, press Master Clock.
  - b** Turn off and disconnect the clock just tested.
  - c** Repeat steps 1 through 14 for the next setup/hold combination listed in step 1 on page 3-29, until all listed setup/hold combinations have been tested.

When aligning the data and clock waveforms using the oscilloscope, align the waveforms according to the setup time of the setup/hold combination being tested, +0.0 ps or -100 ps.

---

# To test the multiple-clock, multiple-edge, state acquisition

Testing the multiple-clock, multiple-edge, state acquisition verifies the performance of the following specifications:

- Minimum master to master clock time.
- Maximum state acquisition speed.
- Setup/Hold time for multiple-clock, multiple-edge, state acquisition.
- Minimum clock pulse width.

This test checks data using multiple clocks at three selected setup/hold times.

---

## Equipment Required

---

Equipment	Critical Specifications	Recommended Model/Part
Pulse Generator	100 MHz 3.5 ns pulse width, < 600 ps rise time	Agilent 8131A option 020
Digitizing Oscilloscope	≥ 6 GHz bandwidth, < 58 ps rise time	Agilent 54121T
Adapter	SMA(m)-BNC(f)	Agilent 1250-1200
SMA Coax Cable (Qty 3)	18 GHz bandwidth	Agilent 8120-4948
BNC Cable	BNC(m)(m) 48 in. >2 GHz bandwidth	Agilent 8120-1840
Coupler	BNC(m)(m)	Agilent 1250-0216
BNC Test Connector, 6x2 (Qty 4)		

---

---

## Set up the equipment

- 1 Turn on the equipment required and the logic analyzer. Let them warm up for 30 minutes before beginning the test if you have not already done so.
- 2 Set up the pulse generator.
  - a Set up the pulse generator according to the following table.

---

### Pulse Generator Setup

---

Channel 1	Channel 2	Period
Delay: 0 ps	Delay: 20.0 ns	40 ns
Width: 4.5 ns	Width: 3.5 ns	
High: -0.9 V	High: -0.9 V	
Low: -1.7 V	Low: -1.7 V	

- b Disable the pulse generator channel 2 COMP (with the LED off).



**3 Set up the oscilloscope.**

**Oscilloscope Setup**

Time Base	Display	Delta V	Delta T
Time/Div: 1.00 ns/div	avg # of avg: 16 screen: dual	V markers on marker 1 position: Chan 1 marker 2 position: Chan 1	T markers on start on: Pos Edge 1 stop on: Neg Edge 1
Channel			
	Channel 1	Channel 2	
<b>Display</b>	on	on	
<b>Probe Atten</b>	20.00	20.00	
<b>Offset</b>	-1.3 V	-1.3 V	
<b>Volts/Div</b>	400 mV	400 mV	

**Set up the logic analyzer**

- 1 Set up the Configuration menu.**
  - a** Press the Config key.
  - b** Assign all pods to Machine 1. To assign pods, select the pod fields, then select Machine 1.
  - c** In the Analyzer 1 box, select the Type field, then select State.

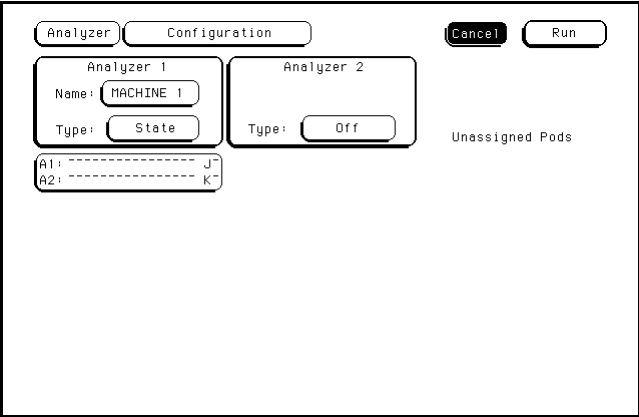

**2 Set up the Format menu.**

- a** Press the Format key. Select State Acquisition Mode, then select Full Channel/4K Memory/50MHz.
- b** Select the field to the right of each Pod field, then select ECL.

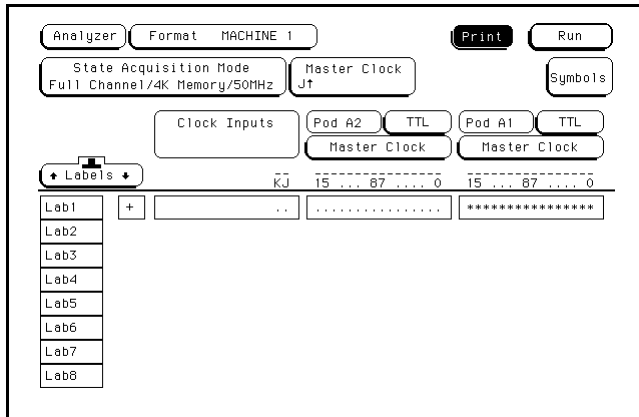

**3 Set up the Trigger menu.**

- a** Press the Trigger key. Select Clear Trigger, then select All.
- b** Select the Count Off field, then select Time in the pop-up menu. Select Done to exit the menu.
- c** Select the field labeled 1 under the State Sequence Levels. Select the field labeled "anystate", then select "no state." Select Done to exit the State Sequence Levels menu.
- d** Select the field next to the pattern recognizer "a," under the label Lab1. Type "000A" , then press Select.

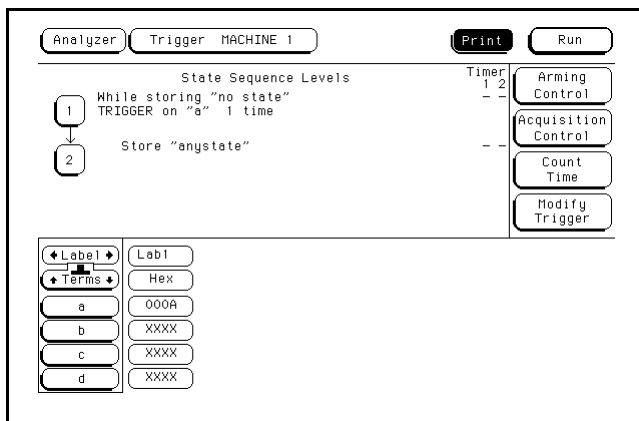

## Connect the logic analyzer

- 1 Using the 6-by-2 test connectors, connect the logic analyzer clock and data channels listed in the following table to the pulse generator. Install a BNC cable between the pulse generator channel 2 output and the 6x2 test connector with the logic analyzer clock leads.
- 2 Using SMA cables, connect channel 1, channel 2, and trigger of the oscilloscope to the pulse generator.

### Connect the 1664A Logic Analyzer to the Pulse Generator

Testing Combination	Connect to Agilent 8131A Channel 1 Output	Connect to Agilent 8131A Channel 1 Output	Connect to Agilent 8131A Channel 2 Output
1	Pod 1, channel 3 Pod 2, channel 3	Pod 1, channel 11 Pod 2, channel 11	J-clock K-clock

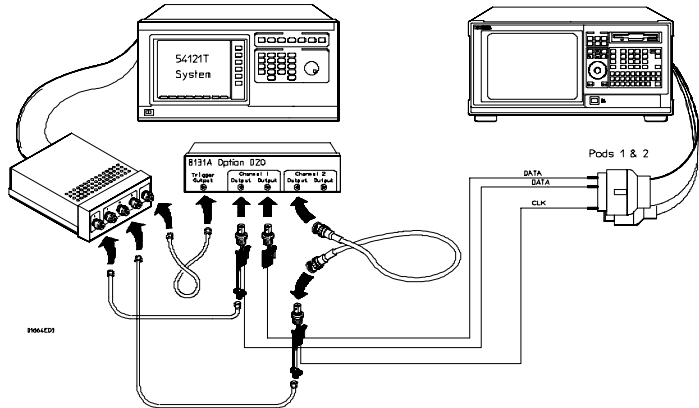

- 3 Activate the data channels that are connected according to the previous table.
  - a Press the Format key.
  - b Select the field showing the channel assignments for one of the pods being tested. Press the Clear entry key. Using the arrow keys, move the selector to the data channels to be tested, then press the Select key. An asterisk means that a channel is turned on. When all the correct channels of the pod are turned on, press the Done key. Follow this step for the remaining pods.

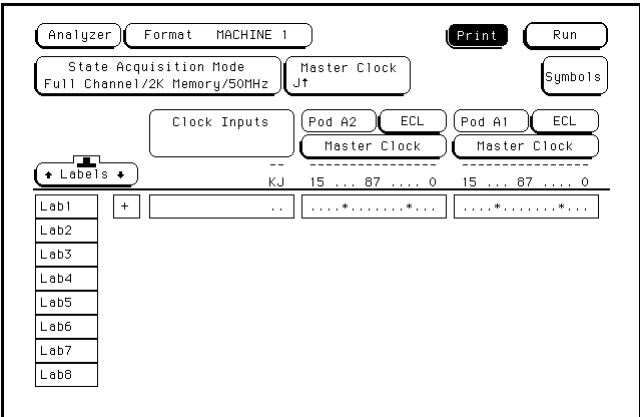

- c Press the Trigger key. Make sure pattern term **a** is "A". If not, select the field next to "a" under the label Lab1. Type "A" then press the Select key.

## Verify the test signal

- 1 Check the clock pulse width. Using the oscilloscope, verify that the clock pulse width is 3.50 ns, +0 ps or -100 ps.
  - a Enable the pulse generator channel 1 and channel 2 outputs (with the LED off).
  - b In the oscilloscope Timebase menu, select Delay. Using the oscilloscope knob, position the clock waveform so that the waveform is centered on the screen.
  - c In the oscilloscope Delta V menu, set the Marker 1 Position to Chan 2, then set Marker 1 at -1.3000 V. Set the Marker 2 Position to Chan 2, then set Marker 2 at -1.3000 V.
  - d In the oscilloscope Delta T menu, select Start On Pos Edge 1. Select Stop On Neg Edge 1.
  - e If the pulse width is outside of the limits, adjust the pulse generator channel 2 width and select the oscilloscope Precision Edge Find until the pulse width is within limits.

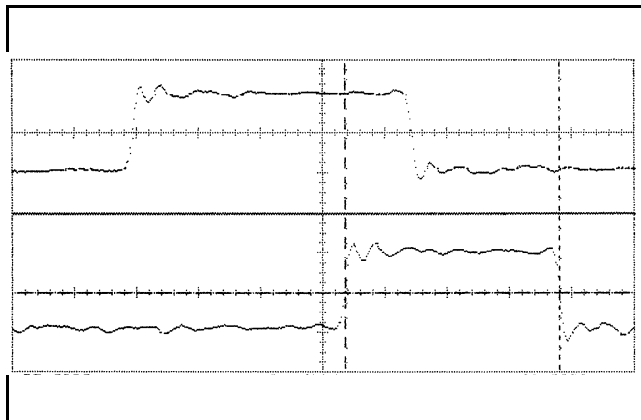

- 2 Check the clock period. Using the oscilloscope verify that the clock period is 20 ns, +0 ps or -250 ps.
  - a In the oscilloscope Timebase menu, select Sweep Speed 4.00 ns/div.
  - b Select Delay. Using the oscilloscope knob, position the clock waveform so that a rising edge appears at the left of the display.

- c In the oscilloscope Measure menu, select Measure Chan 2, then select Period. If the period is more than or equal to 20.000 ns, go to step 4. If the period is less than 20.000 ns but greater than 19.75 ns, go to step 3.
- d In the oscilloscope Timebase menu, add 10 ns to the Delay.
- e In the oscilloscope Measure menu, select Period. If the period is more than or equal to 20.000 ns, decrease the pulse generator Chan 2 DOUB in 100 ps increments until one of the two periods measured is less than 20.000 ns but greater than 19.75 ns.

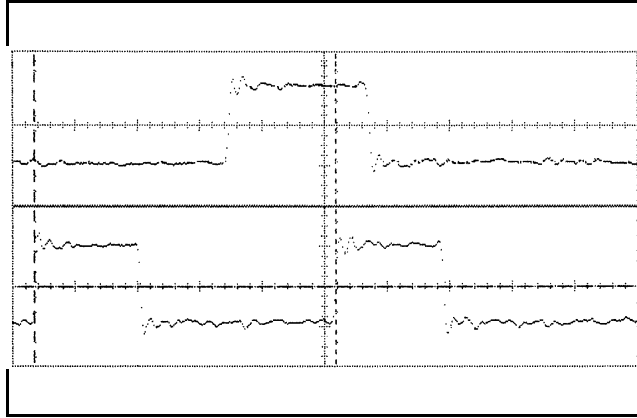

- 3 Check the data pulse width. Using the oscilloscope verify that the data pulse width is 4.450 ns, +50 ps or -100 ps.
  - a In the oscilloscope Timebase menu, select Sweep Speed 1.00 ns/div.
  - b Select Delay. Using the oscilloscope knob, position the data waveform so that the waveform is centered in the screen.
  - c In the oscilloscope Delta V menu, set the Marker 1 Position to Chan 1, then set Marker 1 at -1.3000 V. Set the Marker 2 Position to Chan 1, then set Marker 2 at -1.3000 V.
  - d In the oscilloscope Delta T menu, select Start On Pos Edge 1. Select Stop on Neg Edge 1.
  - e If the pulse width is outside of the limits, adjust the pulse generator channel 1 width and select the oscilloscope Precision Edge Find until the pulse width is within limits.

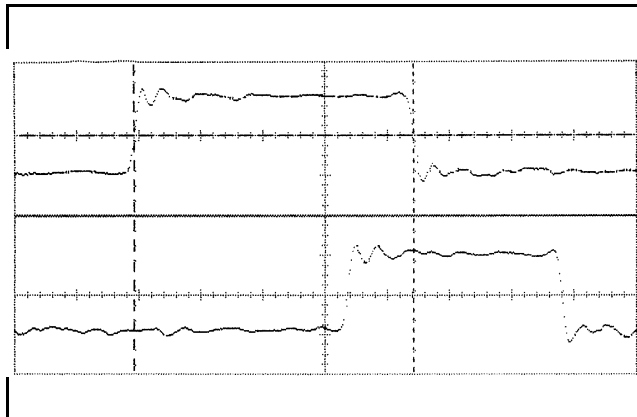

---

## Check the setup/hold with single clock edges, multiple clocks

- 1 Select the logic analyzer setup/hold time.
  - a In the logic analyzer Format menu, select Master Clock.
  - b Select and activate any two clock edges.
  - c Select the Setup/Hold field and select the setup/hold to be tested for all pods. The first time through this test, use the top combination in the following table.

---

### Setup/Hold Combinations

---

4.5/0.0 ns

0.0/4.5 ns

2.0/2.5 ns

- d Select Done to exit the setup/hold combinations.

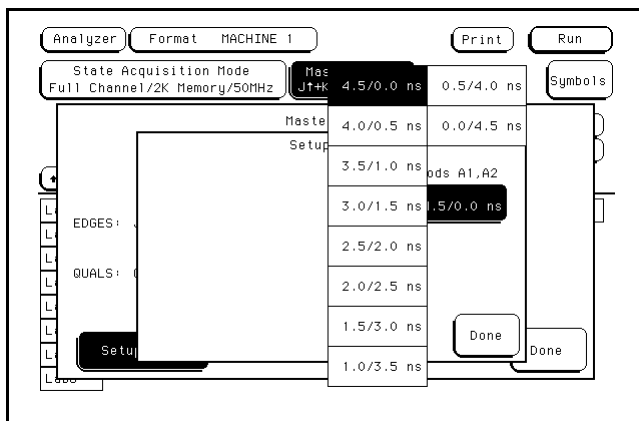

- 2 Disable the pulse generator channel 2 COMP (with the LED off).
- 3 Using the Delay mode of the pulse generator channel 1, position the pulses according to the setup time of the setup/hold combination selected, +0.0 ps or -100 ps.
  - a In the oscilloscope Delta V menu, set the Marker 1 Position to Chan 1, then set Marker 1 at -1.3000 V. Set the Marker 2 Position to Chan 2, then set Marker 2 at -1.3000 V.
  - b In the oscilloscope Delta T menu, select Start on Pos Edge 1. Select Stop on Pos Edge 1.

- c Adjust the pulse generator channel 1 Delay, then select Precision Edge Find in the oscilloscope Delta T menu. Repeat this step until the pulses are aligned according to the setup time of the setup/hold combination selected, +0.0 ps or -100 ps.

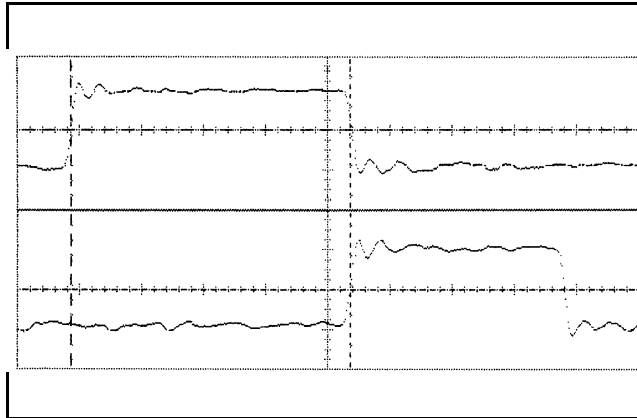

- 4 Select the clocks to be tested.
  - a Select the clock field to be tested and then select  $J\uparrow + K\uparrow$  as the clock edges.
  - b Select Done to exit the Master Clock menu.

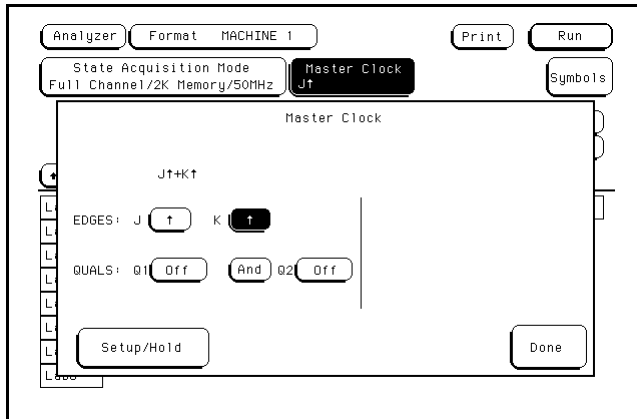

- 5** If you have not already created a Compare file for the previous test (single-clock, single-edge state acquisition, page 3-31), use the following steps to create one. For subsequent passes through this test, skip this step and go to step 6.
- Press Run. The display should show a checkerboard pattern of alternating As and 5s. Verify the pattern by scrolling through the display.
  - Press the List key. In the pop up menu, use the RPG knob to move the cursor to Compare. Press Select.
  - In the Compare menu, move the cursor to Copy Listing to Reference, then select Execute from the pop-up menu and press the Select key.
  - Move the cursor to Specify Stop Measurement and press the Select key. Press Select again to turn on Compare. At the pop up menu, select Compare. Move the cursor to the Equal field and press the Select key. At the pop up menu, select Not Equal. Press Done.
  - Move the cursor to the Reference Listing field and select. The field should toggle to Difference Listing.

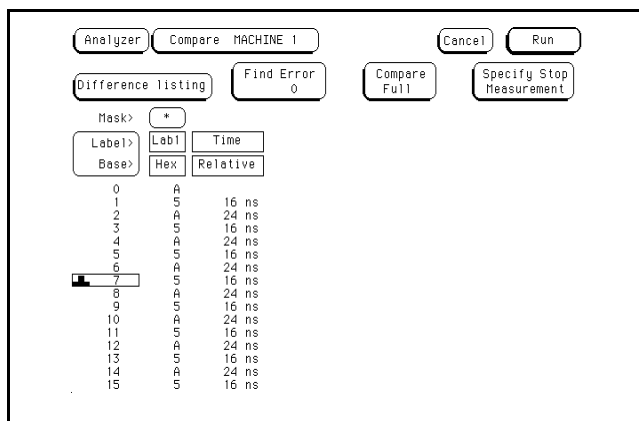

- Press the blue shift key, then press the Run key. If 2 - 4 acquisitions are obtained without the "Stop Condition Satisfied" message appearing, then the test passes. Press Stop to halt the acquisition. Record the Pass or Fail results in the performance test record.
- Enable the pulse generator channel 2 COMP (with the LED on).
- Check the clock pulse width.
  - Enable the pulse generator channel 1 and channel 2 outputs (with the LED off).
  - In the oscilloscope Timebase menu, select Delay. Using the oscilloscope knob, position the clock waveform so that the waveform is centered on the screen.
  - In the oscilloscope Delta V menu, set the Marker 1 Position to Chan 2, then set Marker 1 at  $-1.3000$  V. Set the Marker 2 Position to Chan 2, then set Marker 2 at  $-1.3000$  V.
  - In the oscilloscope Delta T menu, select Start On Neg Edge 1. Select Stop On Pos Edge 1.
  - If the pulse width is outside of the limits, adjust the pulse generator channel 2 width and select the oscilloscope Precision Edge Find until the pulse width is within limits.



- 9 Using the Delay mode of the pulse generator channel 1, position the pulses according to the setup time of the setup/hold combination selected, +0.0 ps or -100 ps.
  - a In the oscilloscope Delta V menu, set the Marker 1 Position to Chan 1, then set Marker 1 at -1.3000 V. Set the Marker 2 Position to Chan 2, then set Marker 2 at -1.3000 V.
  - b In the oscilloscope Delta T menu, select Start On Pos Edge 1. Select Stop on Neg Edge 1.
  - c Adjust the pulse generator channel 1 Delay, then select Precision Edge Find in the oscilloscope Delta T menu. Repeat this step until the pulses are aligned according to the setup time of the setup/hold combination selected, +0.0 ps or -100 ps.

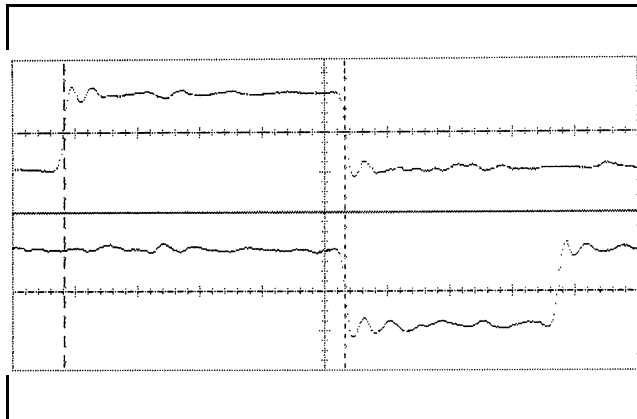

- 10 Select the clocks to be tested.
  - a Select the clock field to be tested, then select J↓ + K↓ as the clock edges.
  - b Select Done to exit the Master Clock menu.

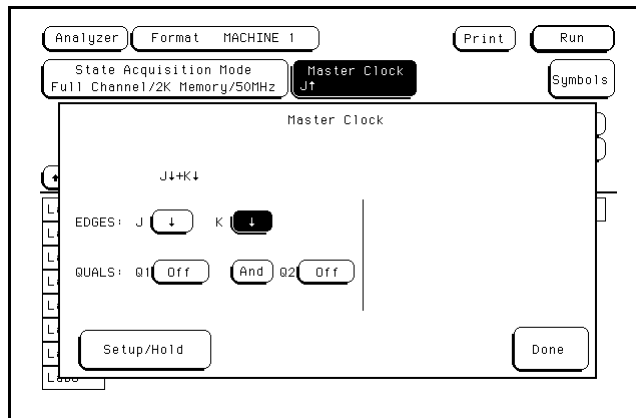

- 11** Press the blue shift key, then press the Run key. If 2 - 4 acquisitions are obtained without the "Stop Condition Satisfied" message appearing, then the test passes. Press Stop to halt the acquisition. Record the Pass or Fail results in the performance test record.
- 12** Test the next setup/hold combination.
  - a** In the logic analyzer Format menu, select Master Clock.
  - b** Turn off and disconnect the clocks just tested.
  - c** Repeat steps 1 through 12 for the next setup/hold combination listed in step 1 on page 3-40, until all listed setup/hold combinations have been tested.

When aligning the data and clock waveforms using the oscilloscope, align the waveforms according to the setup time of the setup/hold combination being tested, +0.0 ps or -100 ps. Then continue through the complete test.

---

# To test the single-clock, multiple-edge, state acquisition

Testing the single-clock, multiple-edge, state acquisition verifies the performance of the following specifications:

- Minimum master to master clock time.
- Maximum state acquisition speed.
- Setup/Hold time for single-clock, multiple-edge, state acquisition.

This test checks data channels using a multiple-edge single clock at three selected setup/hold times.

---

## Equipment Required

Equipment	Critical Specifications	Recommended Model/Part
Pulse Generator	100 MHz 3.5 ns pulse width, < 600 ps rise time	Agilent 8131A option 020
Digitizing Oscilloscope	≥ 6 GHz bandwidth, < 58 ps rise time	Agilent 54121T
Adapter	SMA(m)-BNC(f)	Agilent 1250-1200
SMA Coax Cable (Qty 3)	18 GHz bandwidth	Agilent 8120-4948
BNC Cable	BNC(m)(m) 48 in. >2 GHz bandwidth	Agilent 8120-1840
Coupler	BNC(m)(m)	Agilent 1250-0216
BNC Test Connector, 6x2 (Qty 4)		

---

## Set up the equipment

- 1 Turn on the equipment required and the logic analyzer. Let them warm up for 30 minutes before beginning the test if you have not already done so.
- 2 Set up the pulse generator according to the following table.

---

### Pulse Generator Setup

Channel 1	Channel 2	Period
Doub: 0 ps	Delay: 0 ps	40 ns
Width: 4.0 ns	Dcyc: 50%	
High: -0.9 V	High: -0.9 V	
Low: -1.7 V	Low: -1.7 V	
COMP: Disabled (LED off)	COMP: Disabled (LED off)	

**3** Set up the oscilloscope.

**Oscilloscope Setup**

Time Base	Display	Delta V	Delta T
Time/Div: 1.00 ns/div	avg # of avg: 16 screen: dual	V markers on marker 1 position: Chan 1 marker 2 position: Chan 1	T markers on start on: Neg Edge 1 stop on: Neg Edge 2
Channel			
	Channel 1	Channel 2	
<b>Display</b>	on	on	
<b>Probe Atten</b>	20.00	20.00	
<b>Offset</b>	-1.3 V	-1.3 V	
<b>Volts/Div</b>	400 mV	400 mV	

**Set up the logic analyzer**

- 1** Set up the Configuration menu.
  - a** Press the Config key.
  - b** Assign all pods to Machine 1. To assign all pods, select the pod fields, then select Machine 1.
  - c** Select the Type field in the Analyzer 1 box, then select State.

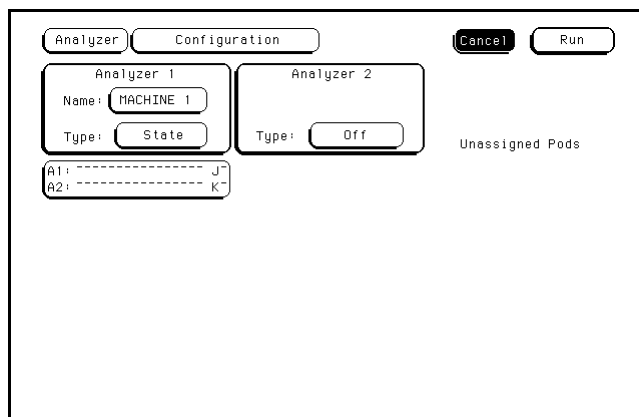

**2 Set up the Format menu.**

- a** Press the Format key. Select State Acquisition Mode, then select Full Channel/4K Memory/50MHz.
- b** Select the field to the right of each pod field, then select ECL.

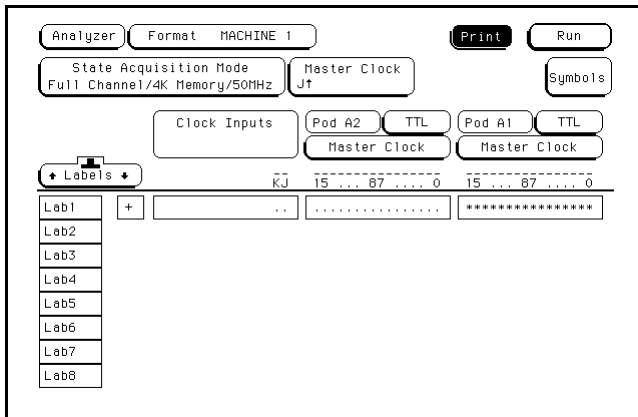

**3 Set up the Trigger menu.**

- a** Press the Trigger key. Select Clear Trigger, then select All.
- b** Select the Count Off field, then select Time in the pop-up menu. Select Done to exit the menu.
- c** Select the field labeled 1 under the State Sequence Levels. Select the field labeled "anystate", then select "no state." Select Done to exit the State Sequence Levels menu.
- d** Select the field next to the pattern recognizer "a," under the label Lab1. Type "000A", then press Select.

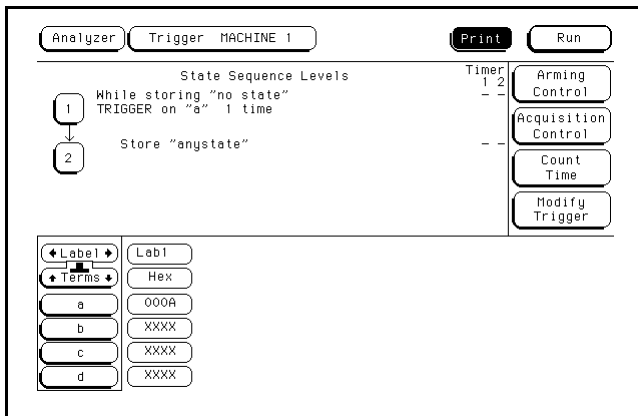

## Connect the logic analyzer

- 1 Using the 6-by-2 test connectors, connect the logic analyzer clock and data channels listed in the following table to the pulse generator. Install a BNC cable between the pulse generator channel 2 output and the 6x2 test connector with the logic analyzer clock leads.
- 2 Using SMA cables, connect channel 1, channel 2, and trigger of the oscilloscope to the pulse generator.

### Connect the 1664A Logic Analyzer to the Pulse Generator

Testing Combination	Connect to Agilent 8131A Channel 1 Output	Connect to Agilent 8131A Channel 2 Output	Connect to Agilent 8131A Channel 3 Output
1	Pod 1, channel 3 Pod 2, channel 3	Pod 1, channel 11 Pod 2, channel 11	J-clock

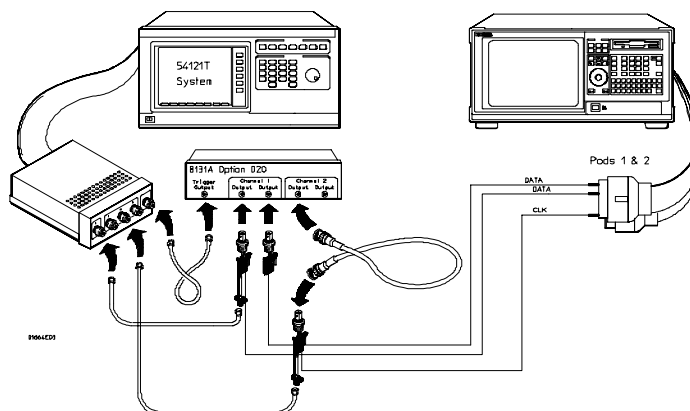

- 3 Activate the data channels that are connected according to the previous tables.
  - a Press the Format key.
  - b Select the field showing the channel assignments for one of the pods being tested. Press the Clear entry key. Using the arrow keys, move the selector to the data channels to be tested, then press the Select key. An asterisk means that a channel is turned on. When all the correct channels of the pod are turned on, press the Done key. Follow this step for the remaining pods.

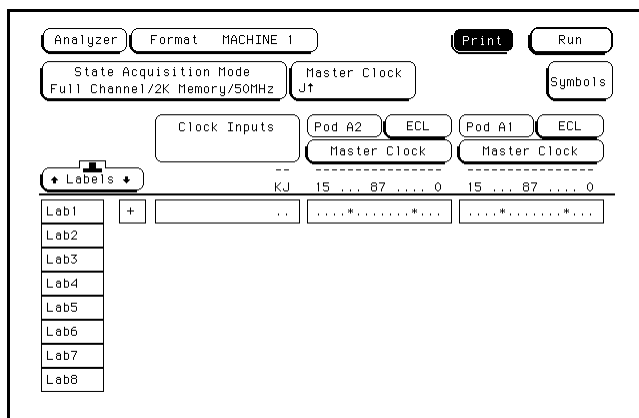

- c Press the Trigger key. Make sure pattern term **a** is "A". If not, select the field next to "a" under the label Lab1. Type "A" then press the Select key.

---

## Verify the test signal

- 1 Check the clock period. Using the oscilloscope, verify that the clock period is 20 ns, +0 ps or -250 ps.
  - a In the oscilloscope Timebase menu, select Sweep Speed 4.00 ns/div.
  - b Select Delay. Using the oscilloscope knob, position the clock waveform (Channel 2) so that a rising edge appears at the left of the display.
  - c In the oscilloscope Measure menu, select Measure Chan 2, then select +Width. If the positive-going pulse width is more than 20.000 ns, go to step d. If the pulse width is less than or equal to 20.000 ns, go to step 2.
  - d In the oscilloscope Measure menu, select -Width. If the negative-going pulse width is less than or equal to 20.000 ns but greater than 19.75 ns, go to step 2.
  - e Decrease the pulse generator Period in 100 ps increments until the oscilloscope Measure +Width or Measure -Width reads less than or equal to 20.000 ns, but greater than 19.75 ns.

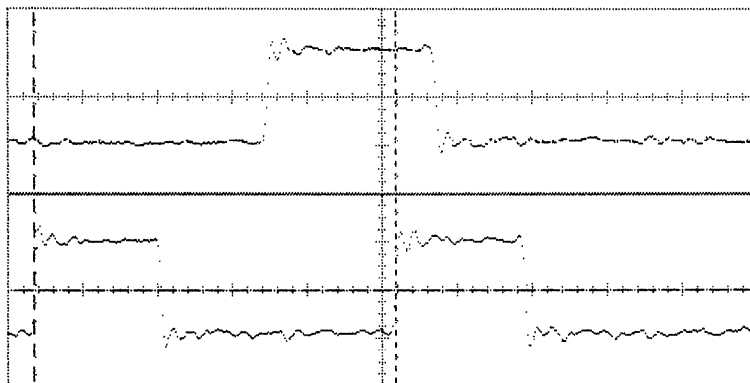

- 2 Check the data pulse width. Using the oscilloscope, verify that the data pulse width is 4.000 ns,  $\pm 0$  ps or  $\pm 100$  ps.
  - a In the oscilloscope Timebase menu, select Sweep Speed 1.00 ns/div.
  - b Select Delay. Using the oscilloscope knob, position the data waveform (Channel 1) so that the waveform is centered on the screen.
  - c In the oscilloscope Delta V menu, set the Marker 1 Position to Chan 1, then set Marker 1 at  $-1.3000$  V. Set the Marker 2 Position to Chan 1, then set Marker 2 at  $-1.3000$  V.
  - d In the oscilloscope Delta T menu, select Start On Pos Edge 1. Select Stop on Neg Edge 1. Select Precision Edge Find.
  - e If the pulse width is outside of the limits, adjust the pulse generator channel 1 width and select the oscilloscope Precision Edge Find until the pulse width is within limits.

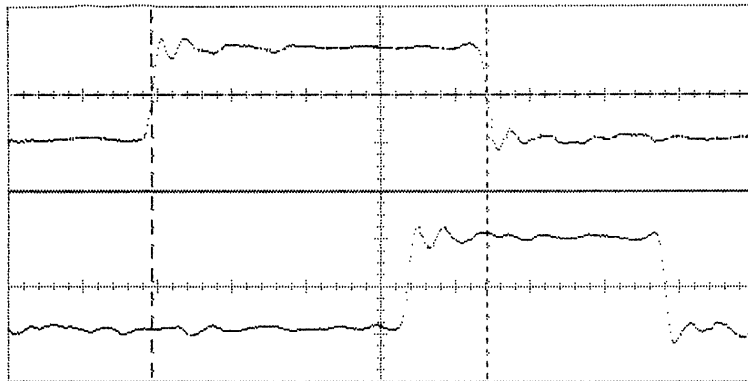



## Check the setup/hold combination

- 1 Select the logic analyzer setup/hold time.
  - a In the logic analyzer Format menu, select Master Clock.

**NOTE**

The first time through this test, assign the clocks according to the first testing combination in step 3 of these procedures.

- b In the Master Clock menu, select Setup/Hold.
  - c In the Setup/Hold menu, select the setup/hold field, then select for all pods the setup/hold combination to be tested. The first time through this test, use the top combination in the following table.

### Setup/Hold Combinations

4.0/0.0 ns  
 0.0/4.0 ns  
 2.0/2.0 ns

- d Select Done to exit the setup/hold combinations.

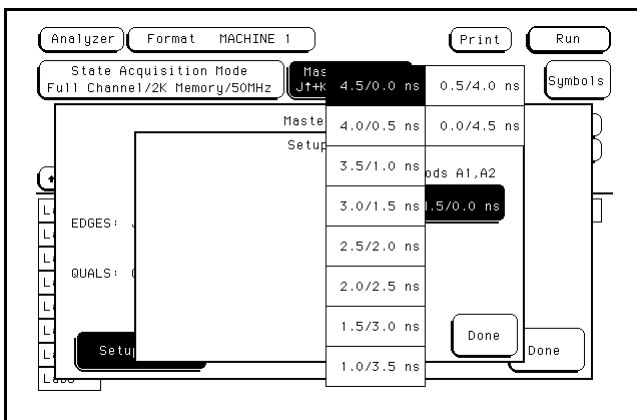

- 2 Using the Delay mode of the pulse generator Channel 2, position the pulses according to the setup time of the setup/hold combination selected, +0.0 ps or -100.0 ps.
  - a In the oscilloscope Delta V menu, set the Marker 1 Position to Chan 1, then set Marker 1 at -1.3000 V. Set the Marker 2 Position to Chan 2, then set Marker 2 at -1.3000 V.
  - b In the oscilloscope Delta T menu, select Start on Pos Edge 1. Select Stop on Pos Edge 1. Select Precision Edge Find.

- c Adjust the pulse generator channel 2 Delay, then select Precision Edge Find in the oscilloscope Delta T menu. Repeat this step until the pulses are aligned according to the setup time of the setup/hold combination selected, +0.0 ps or -100 ps.

**NOTE** If the rising clock edge does not appear on the oscilloscope display, then add 20.0 ns to the oscilloscope Timebase Delay.

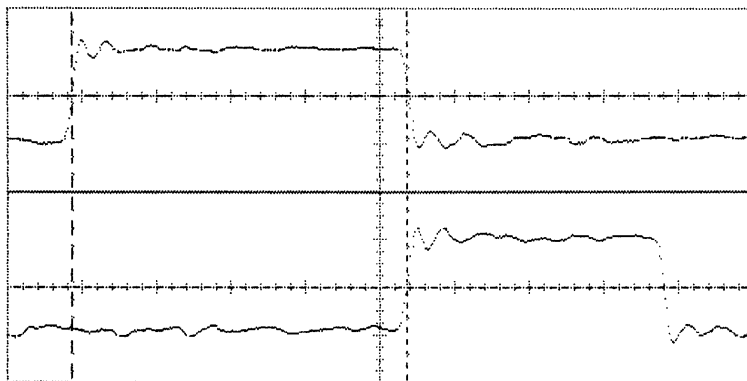

- 3 Select the clock to be tested.
- a In the Master Clock menu, select the clock field to be tested, then select the clock edge as indicated in the table. The first time through this test, use the top clock and edge in the following table.

---

**Clocks**

---

J↕

K↕

- b Select Done to exit the Master Clock menu.
- 4 If a Compare file was not created during the single-clock, single-edge test, then the first time through this test, create a Compare file.
- a Press Run. The display should show a checkerboard pattern of alternating A and 5. Scroll through the display to verify.
- b Press the List key. In the pop up menu, use the RPG knob to move the cursor to Compare. Press Select.
- c In the Compare menu, move the cursor to Copy Listing to Reference, then press the Select key.
- d Move the cursor to Specify Stop Measurement and press the Select key. Press Select again to turn on Compare. At the pop up menu, select Compare. Move the cursor to the Equal field and press the Select key. At the pop up menu, select Not Equal. Press Done.
- e Move the cursor to the Reference Listing field and select. The field should toggle to Difference Listing.
- 5 Press the blue shift key, then press the Run key. If 2 - 4 acquisitions are obtained without the "Stop Condition Satisfied" message appearing, then the test passes. Press Stop to halt the acquisition. Record the Pass or Fail results in the performance test record.

- 6** Test the next clock.
  - a** Press the Format key, then select Master Clock.
  - b** Turn off and disconnect the clock just tested.
  - c** Repeat steps 3 and 5 for the next clock listed in the table in step 3, until all listed clock edges have been tested.
- 7** Test the next setup/hold combination. **a** Press the Format key, then select Master Clock and turn off the clock just tested. **b** Repeat steps 1 through 7 for the next setup/hold combination listed in step 1, until all listed setup/hold combinations have been tested.

When aligning the data and clock waveforms using the oscilloscope, align the waveforms according to the setup time of the setup/hold combination being tested, +0.0 ps or -100.0 ps.

---

## To test the time interval accuracy

Testing the time interval accuracy does not check a specification, but does check the following:

- 125 MHz oscillator

This test verifies that the 125 MHz timing acquisition synchronizing oscillator is operating within limits.

---

### Equipment Required

---

Equipment	Critical Specifications	Recommended Model/Part
Pulse Generator	100 MHz 3.5 ns pulse width, < 600 ps rise time	Agilent 8131A Option 020
Function Generator	Accuracy $\leq (5)(10^{-6}) \times \text{frequency}$	Agilent 3325B Option 002
SMA Cable		Agilent 8120-4948
Adapter	BNC(m)-SMA(f)	Agilent 1250-2015
BNC Test Connector, 6x2		

---

---

### Set up the equipment

- 1 Turn on the equipment required and the logic analyzer. Let them warm up for 30 minutes if you have not already done so.
- 2 Set up the pulse generator according to the following table.

---

### Pulse Generator Setup

---

Channel 1	Period	Mode	EXT TRIG
Delay: 0 ps	5 us	TRIG	Slope: Positive
Width: 2.5 us			THRE: 1.0 V
High: -0.9 V			
Low: -1.7 V			
COMP: Disabled (LED off)			

---

**3** Set up the function generator according to the following table.

---

**Function Generator Setup**

---

Freq: 200 000 . 0 Hz	Main Function: Square wave
Amptd: 3.000 V	High Voltage: Disabled (LED Off)
Phase: 0.0 deg	
DC Offset: 0.0 V	

---

**Set up the logic analyzer**

**1** Set up the Configuration menu.

- a** Press the Config key.
- b** In the Configuration menu, assign Pod 1 to Machine 1. To assign Pod 1, select the Pod 1 field, then select Machine 1.
- c** In the Analyzer 1 box, select the Type field, then select Timing.

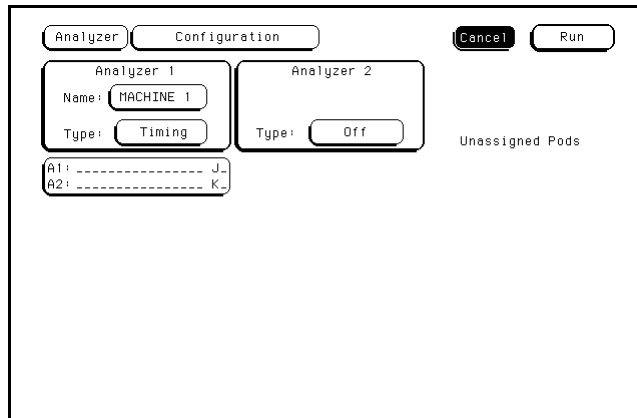

Testing Performance  
To test the time interval accuracy

2 Set up the Format menu.

- a Press the Format key. Select Timing Acquisition Mode, then select Transitional Full Channel 125 MHz.
- b Select the field to the right of the Pod 1 field, then select ECL.
- c Select the field showing the channel assignments for Pod 1. Deactivate all channels by pressing the Clear entry key. Using the arrow keys, move the selector to Channel 0. Press the Select key to put an asterisk in the channel position, activating the channel, then press the Done key.

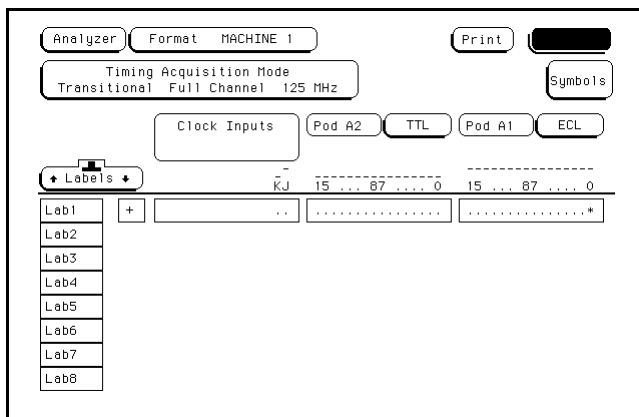

3 Press the Trigger key. Select Modify Trigger, then Clear Trigger and All from the pop-up menus.

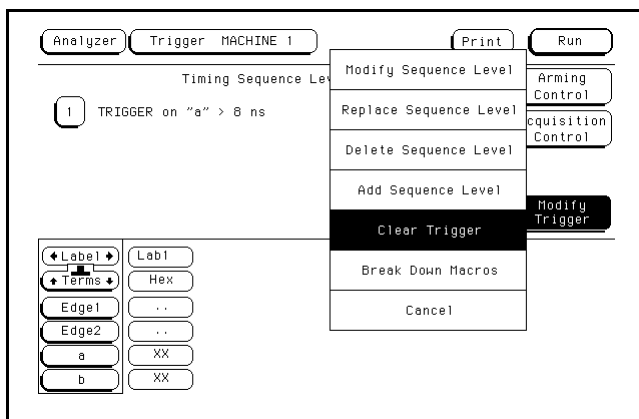

- 4 Set up the Waveform menu.
  - a Press the Waveform key.
  - b Move the cursor to the sec/Div field, then use the RPG knob to dial in 2.00  $\mu$ s.
  - c Select the Markers Off field, then select Pattern.
  - d Select the Specify Patterns field. Select X entering 1 and O entering 1.

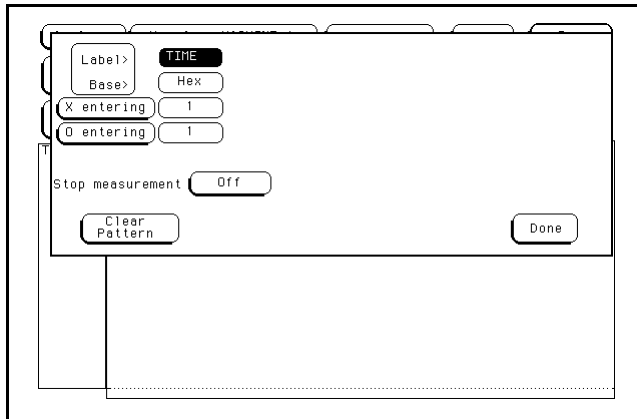

- e Select Done to exit the Specify Patterns menu.
- f Move the cursor to the X-pat field. Type 1, then press Done.
- g Move the cursor to the O-pat field. Type 20, then press Done.
- h Select the Markers Patterns field, then select Statistics. Select Reset Statistics to initialize the statistics fields.

---

## Connect the logic analyzer

- 1 Using a 6-by-2 test connector, connect channel 0 of Pod 1 to the pulse generator channel 1 output.
- 2 Using the SMA cable and the BNC adapter, connect the External Input of the pulse generator to the Main Signal of the function generator.

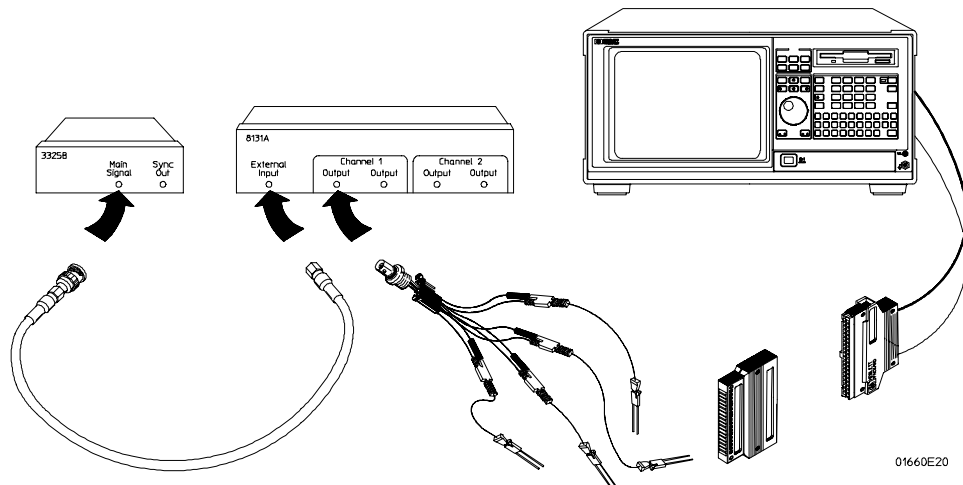

---

## Acquire the data

- 1 Enable the pulse generator channel 1 output (with the LED off).
- 2 Press the blue key, then press the Run key to select Run-Repetitive. Allow the logic analyzer to acquire data for at least 100 valid runs as indicated in the pattern statistics field.
- 3 When the logic analyzer has acquired at least 100 valid runs, touch Stop. The Min X-O field in the logic analyzer Pattern Statistics menu should read 94.99–95.00  $\mu\text{s}$ . The Max X-O field should read 95.00–95.01  $\mu\text{s}$ . The Avg X-O field should read 94.99–95.01  $\mu\text{s}$ . Record the results in the performance test record.

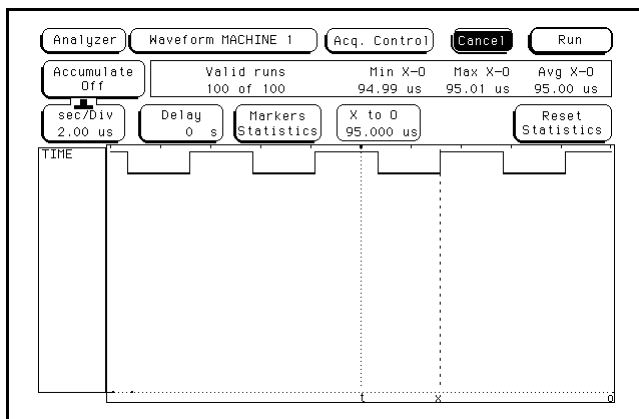



# Performance Test Record

## Performance Test Record

**1664A Logic Analyzer** \_\_\_\_\_

Serial No. \_\_\_\_\_

Work Order No. \_\_\_\_\_

Recommended Test Interval - 2 Year/4000 hours

Date \_\_\_\_\_

Recommended next testing \_\_\_\_\_

Temperature \_\_\_\_\_

Test	Settings	Results			
<b>Self-Tests</b>		Pass/Fail _____			
<b>Threshold Accuracy</b>	± (100 mV + 3% of threshold setting)	Limits                      Measured			
Pod 1	TTL, ±145 mV	TTL VL	+1.355 V	_____	
		TTL VH	+1.645 V	_____	
	ECL, ±139 mV	ECL VL	-1.439 V	_____	
		ECL VH	-1.161 V	_____	
	-User, ±280 mV	-User VL	-6.280 V	_____	
		- User VH	-5.720 V	_____	
	+User, ±280 mV	+ User VL	+5.720 V	_____	
		+ User VH	+6.280 V	_____	
	0 V, ±100 mV	0 V User VL	-100 mV	_____	
		0 V User VH	+100 mV	_____	
	Pod 2	TTL, ±145 mV	TTL VL	+1.355 V	_____
			TTL VH	+1.645 V	_____
ECL, ±139 mV		ECL VL	-1.439 V	_____	
		ECL VH	-1.161 V	_____	
-User, ±280 mV		-User VL	-6.280 V	_____	
		- User VH	-5.720 V	_____	
+User, ±280 mV		+ User VL	+5.720 V	_____	
		+ User VH	+6.280 V	_____	
0 V, ±100 mV		0 V User VL	-100 mV	_____	
		0 V User VH	+100 mV	_____	
<b>Glitch Capture</b>		Minimum Detectable Glitch 3.5 ns	Pass/Fail		
		Pod 1	_____		
	Pod 2	_____			

**Performance Test Record (continued)**

Test	Settings		Results			
<b>Single-Clock, Single-Edge Acquisition</b>          <b>Multiple-Clock, Multiple-Edge Acquisition</b>	Setup/Hold Time	3.5/0.0 ns	J↑ K↑	_____	J↓ K↓	_____
	Setup/Hold Time	0.0/3.5 ns	J↑ K↑	_____	J↓ K↓	_____
	Setup/Hold Time	1.5/2.5 ns	J↑ K↑	_____	J↓ K↓	_____
	Setup/Hold Time	4.5/0.0 ns	J↑ + K↑	_____	J↓ + K↓	_____
	Setup/Hold Time	0.0/4.5 ns	J↑ + K↑	_____	J↓ + K↓	_____
	Setup/Hold Time	2.0/2.5 ns	J↑ + K↑	_____	J↓ + K↓	_____
<b>Single-Clock, Multiple-Edge Acquisition</b>	Setup/Hold Time	4.0/0.0 ns	J↓ K↓	_____	_____	_____
	Setup/Hold Time	0.0/4.0 ns	J↓ K↓	_____	_____	_____
	Setup/Hold Time	2.0/2.0 ns	J↓ K↓	_____	_____	_____
<b>Time Interval Accuracy</b>	min X-0	94.99-95.00 μs	Measured  _____ _____ _____			
	max X-0	95.00-95.01 μs				
	avg X-0	94.99-95.01 μs				

Logic analyzer calibration 4-2

To adjust the CRT monitor alignment 4-3

To adjust the CRT intensity 4-5

---

## Calibrating and Adjusting

---

# Calibrating and Adjusting

This chapter gives you instructions for calibrating and adjusting the logic analyzer.

Adjustments to the logic analyzer include adjusting the CRT monitor assembly.

To periodically verify the performance of the analyzer, refer to "Testing Performance" in chapter 3.

---

## Logic analyzer calibration

The logic analyzer circuitry of the 1664A Logic Analyzer does not require an operational accuracy calibration. To test the logic analyzer circuitry against specifications (full calibration), refer to chapter 3, Testing Performance.

---

## Set up the equipment

Turn on the logic analyzer. Let it warm up for 30 minutes if you have not already done so.

---

# To adjust the CRT monitor alignment

---

**WARNING**

---

Do not touch the CRT monitor sweep board. High voltages exist on the sweep board that can cause personal injury.

---

**Equipment Required**

---

<b>Equipment</b>	<b>Critical Specification</b>	<b>Recommended Model/Part</b>
Alignment Tool	1	8710-1300

- 1** Turn off the logic analyzer, then disconnect the power cord. Remove the cover. Refer to chapter 6, "Replacing Assemblies," for instructions to remove the cover.
- 2** Connect the power cord, insert the operating system disk into the disk drive, then turn on the logic analyzer.
- 3** Insert the disk containing the functional performance verification tests (normally the same disk) into the disk drive, then load the functional performance verification operating system into the logic analyzer (refer to Chapter 3, To Perform Self Tests).

Calibrating and Adjusting  
**To adjust the CRT monitor alignment**

**4** Enter the Sys PV tests, then enter the Display Test.

A grid pattern should appear.

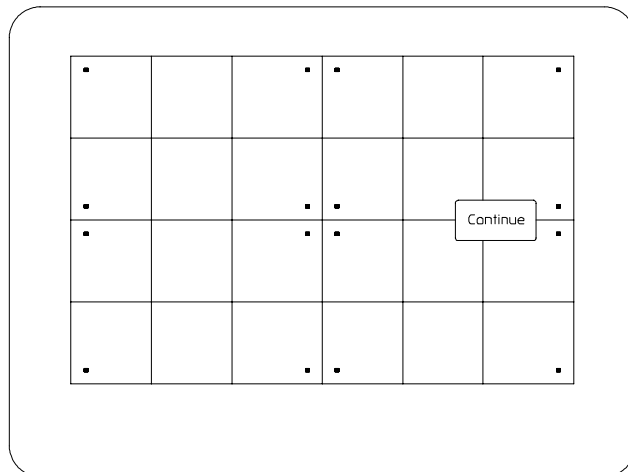

01660b41

**5** If the display is tilted (rotated), adjust the CRT yoke by rotating it to straighten the display.

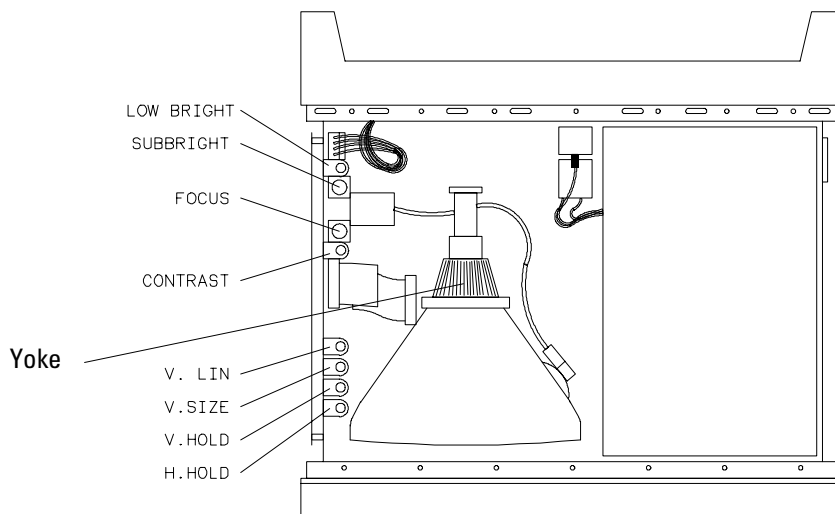

01660E22

**6** If the grid pattern is not centered horizontally, adjust the H-Hold.

**7** If you need to adjust the intensity, go to the next page.

If you are finished with the adjustments, turn off the instrument, then remove the power cord. Install the cover on the instrument.

---

# To adjust the CRT intensity

---

**WARNING**

---

Do not touch the CRT monitor sweep board. High voltages exist on the sweep board that can cause personal injury.

---

**Equipment Required**

---

Equipment	Critical Specification	Recommended Model/Part
Alignment Tool	1	8710-1300
Light Power Meter		United Detector 351

- 1 Turn off the logic analyzer, then disconnect the power cord. Remove the cover. Refer to chapter 6, "Replacing Assemblies," for instructions to remove the cover.
- 2 Connect the power cord, insert the operating system disk, then turn on the logic analyzer.
- 3 Access the Display Test.
  - If you just finished adjusting the CRT monitor alignment, go to step 4.
  - To Access the Display Test, perform the following steps.
    - a Insert the disk containing the functional performance verification tests (normally the same disk) into the disk drive, then load the functional performance verification operating system into the logic analyzer (refer to Chapter 3, To Perform The Self Tests).
    - b Enter the Sys PV tests and enter the Display Test. A grid pattern should appear.
- 4 Press the front panel Select key.

The display should show a full bright test screen.
- 5 Turn the rear panel intensity adjustment to full bright.
- 6 Place the light power meter against the display at center screen.

Calibrating and Adjusting  
To adjust the CRT intensity

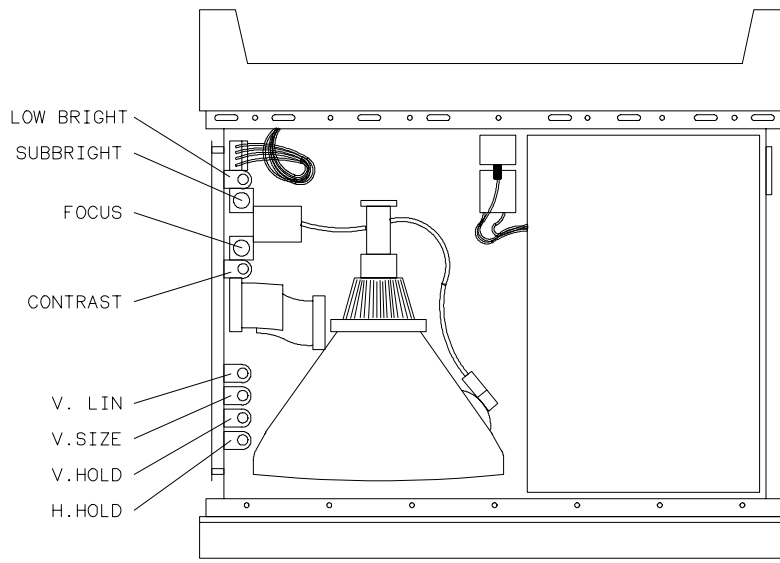

**WARNING**

Do not touch the CRT monitor sweep board. High voltages exist on the sweep board that can cause personal injury.

- 7 The light power meter should read 137-154  $\text{cd/m}^2$ . If the measurement is out of this range, use the adjustment tool to adjust the Contrast potentiometer on the monitor driver board.
- 8 Press the front panel Select key.  
The display should show a half bright test screen.
- 9 Place the light power meter against the display at center screen. The light power meter should read 5-27  $\text{cd/m}^2$ .  
If the reading is not correct, try adjusting the contrast in step 7 closer to the limit.
- 10 Press the front panel Select key.  
The logic analyzer should exit the Display Test.
- 11 Place the light power meter against the display at center screen. Adjust the rear panel intensity adjustment until the light power meter reads 45-55  $\text{cd/m}^2$ .
- 12 Exit the functional performance verification tests.
- 13 Turn off the instrument, then remove the power cord. Install the cover on the instrument.



- To use the flowcharts 5-2
- To check the power-up tests 5-15
- To run the self-tests 5-16
- To test the power supply voltages 5-21
- To test the CRT monitor signals 5-23
- To test the keyboard signals 5-24
- To test the disk drive voltages 5-25
- To perform the BNC test 5-27
- To test the logic analyzer probe cables 5-28
- To test the auxiliary power 5-32

---

## Troubleshooting

---

# Troubleshooting

This chapter helps you troubleshoot the logic analyzer to find defective assemblies. The troubleshooting consists of flowcharts, self-test instructions, and tests. This information is not intended for component-level repair.

If you suspect a problem, start at the top of the first flowchart. During the troubleshooting instructions, the flowcharts will direct you to perform other tests.

The service strategy for this instrument is the replacement of defective assemblies. This instrument can be returned to Agilent Technologies for all service work, including troubleshooting. Contact your nearest Agilent Technologies Sales Office for more details.

---

**CAUTION**

---

Electrostatic discharge can damage electronic components. Use grounded wriststraps and mats when you perform any service to this instrument or to the cards in it.

---

## To use the flowcharts

Flowcharts are the primary tool used to isolate defective assemblies. The flowcharts refer to other tests to help isolate the trouble. The circled letters on the charts indicate connections with the other flowcharts. Start your troubleshooting at the top of the first flowchart.

CHART 1

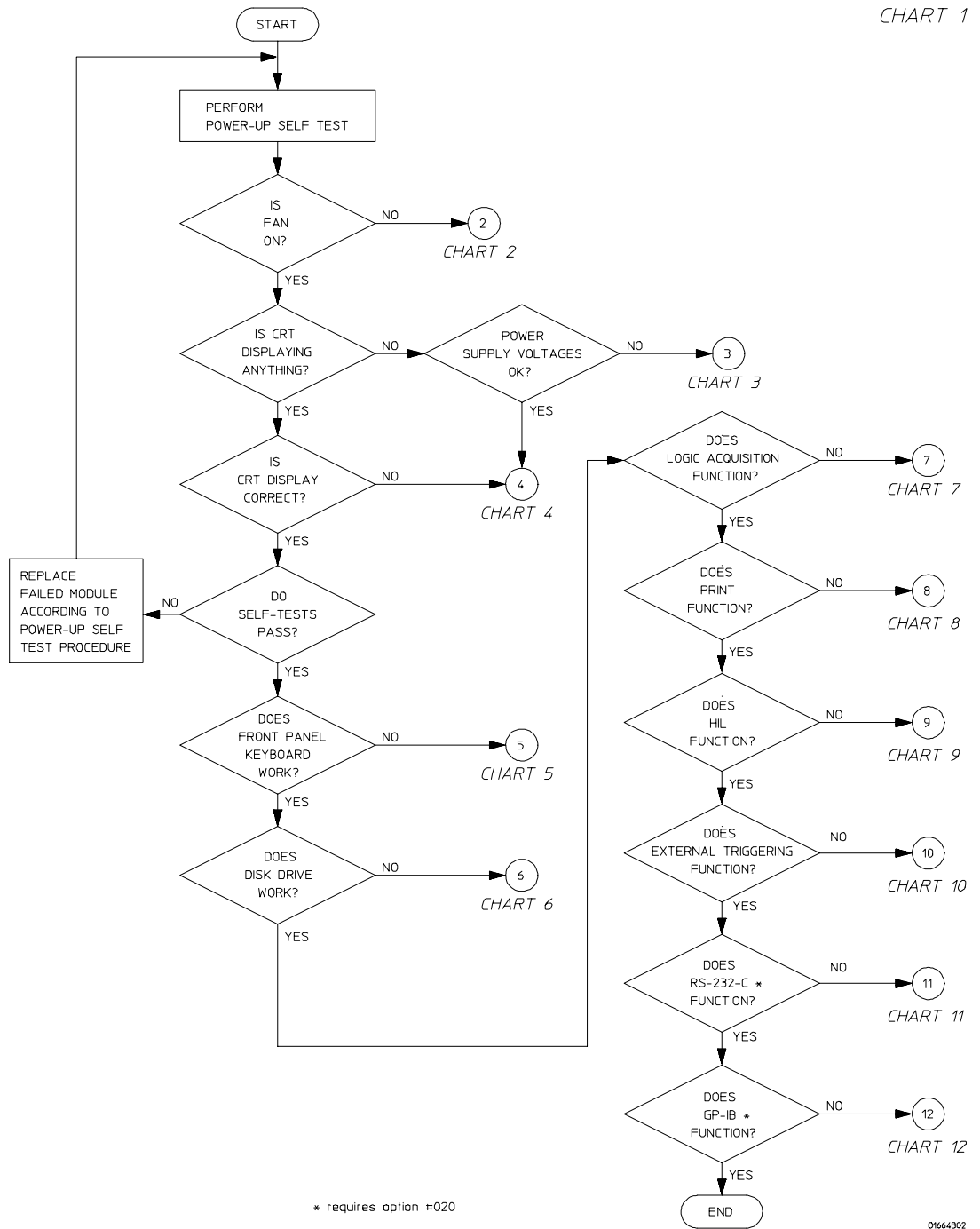

Troubleshooting Flowchart 1

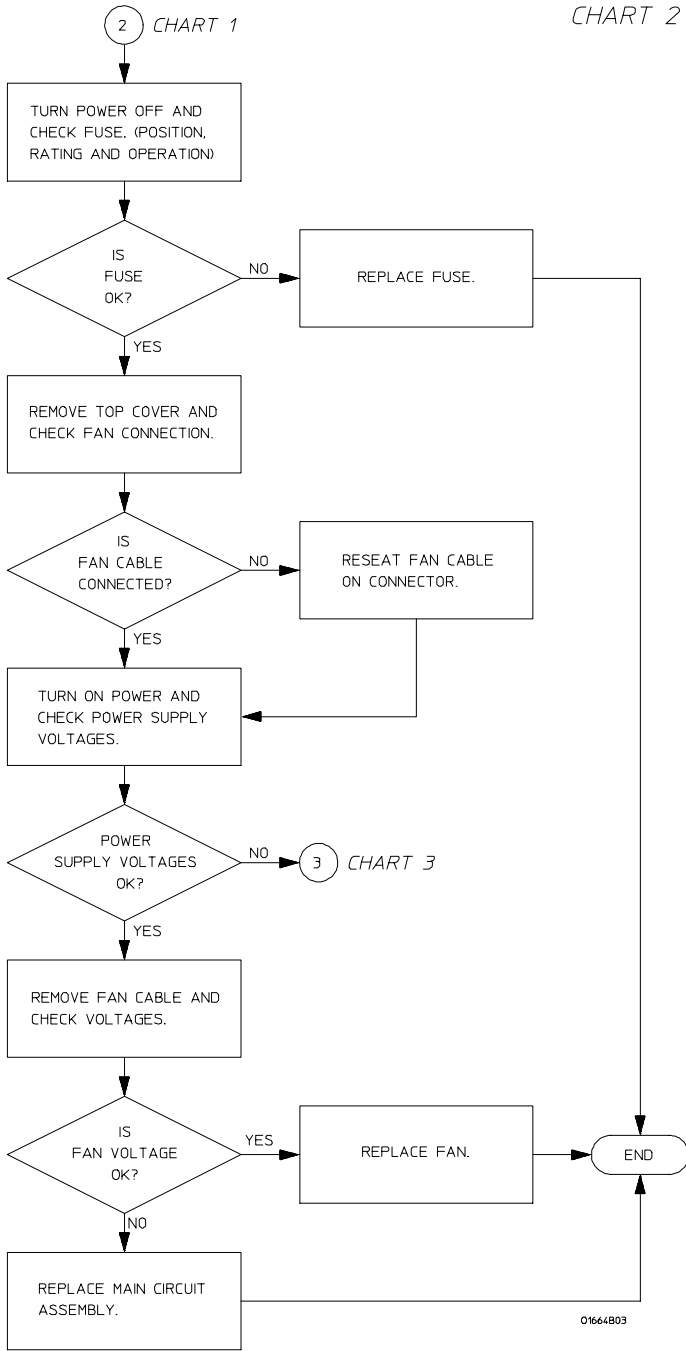

Troubleshooting Flowchart 2

CHART 3

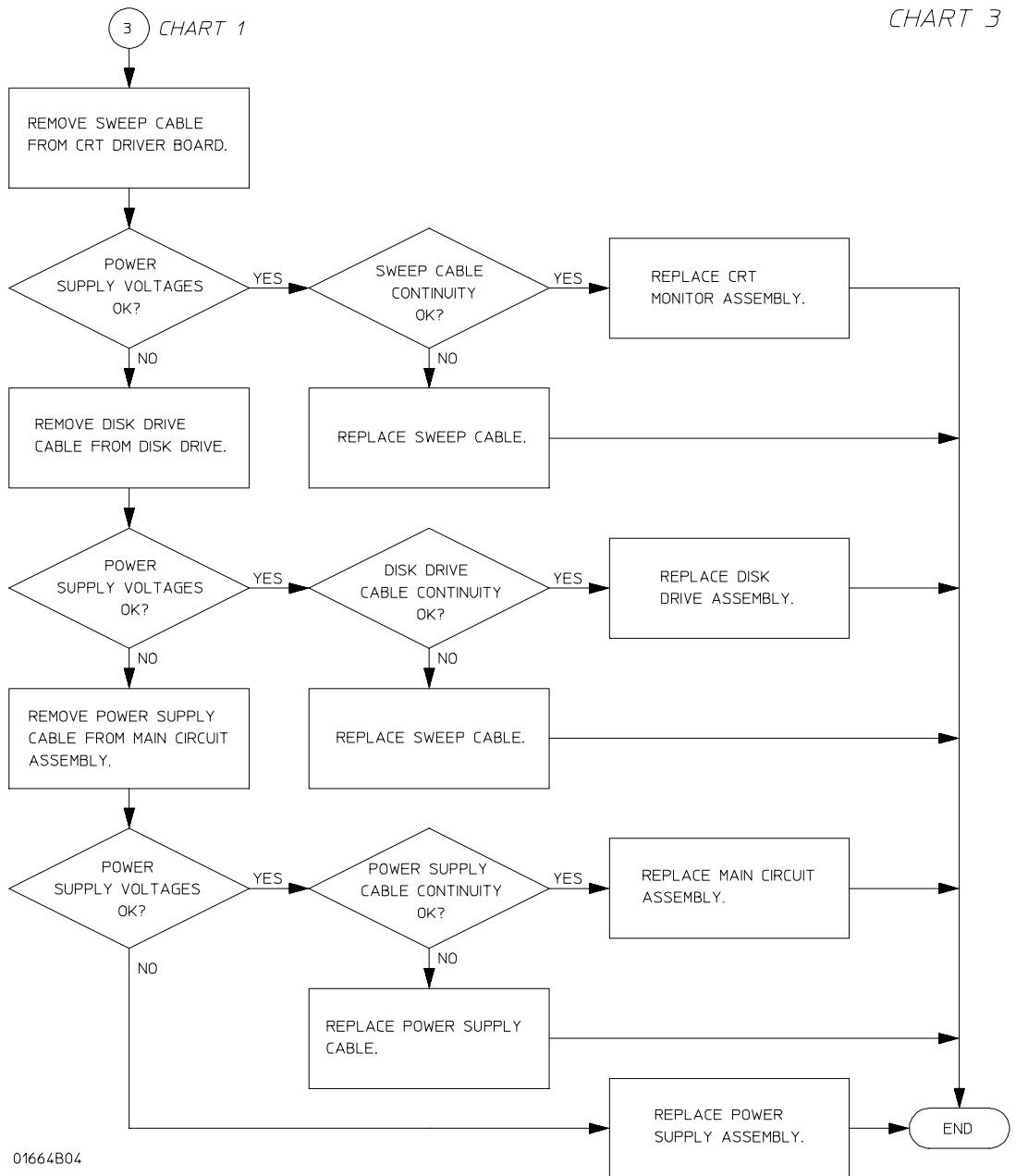

Troubleshooting Flowchart 3

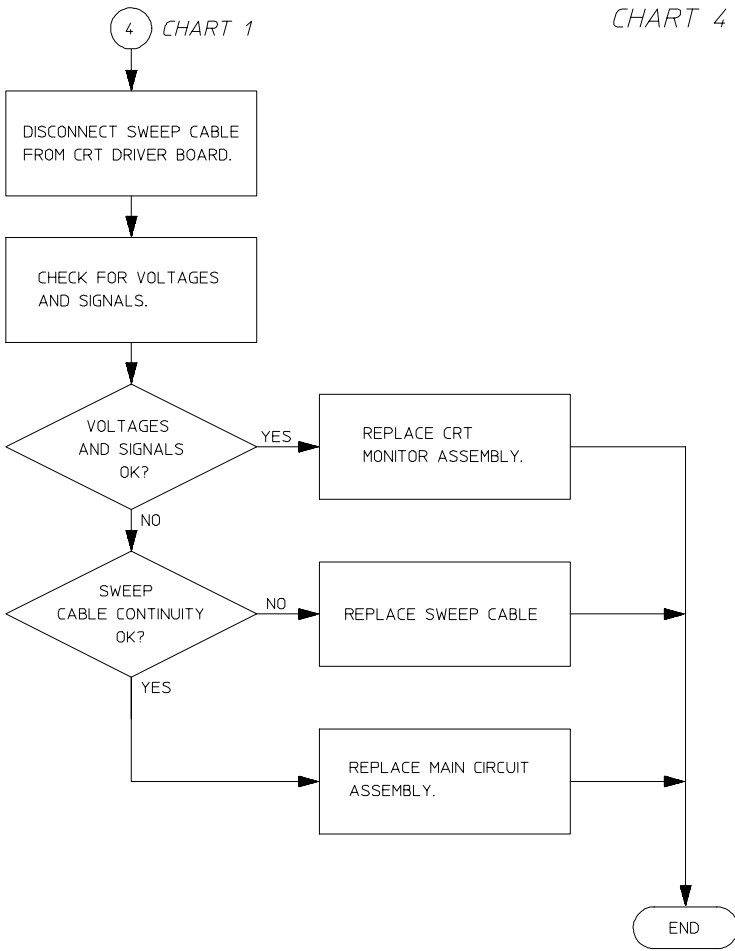

**Troubleshooting Flowchart 4**

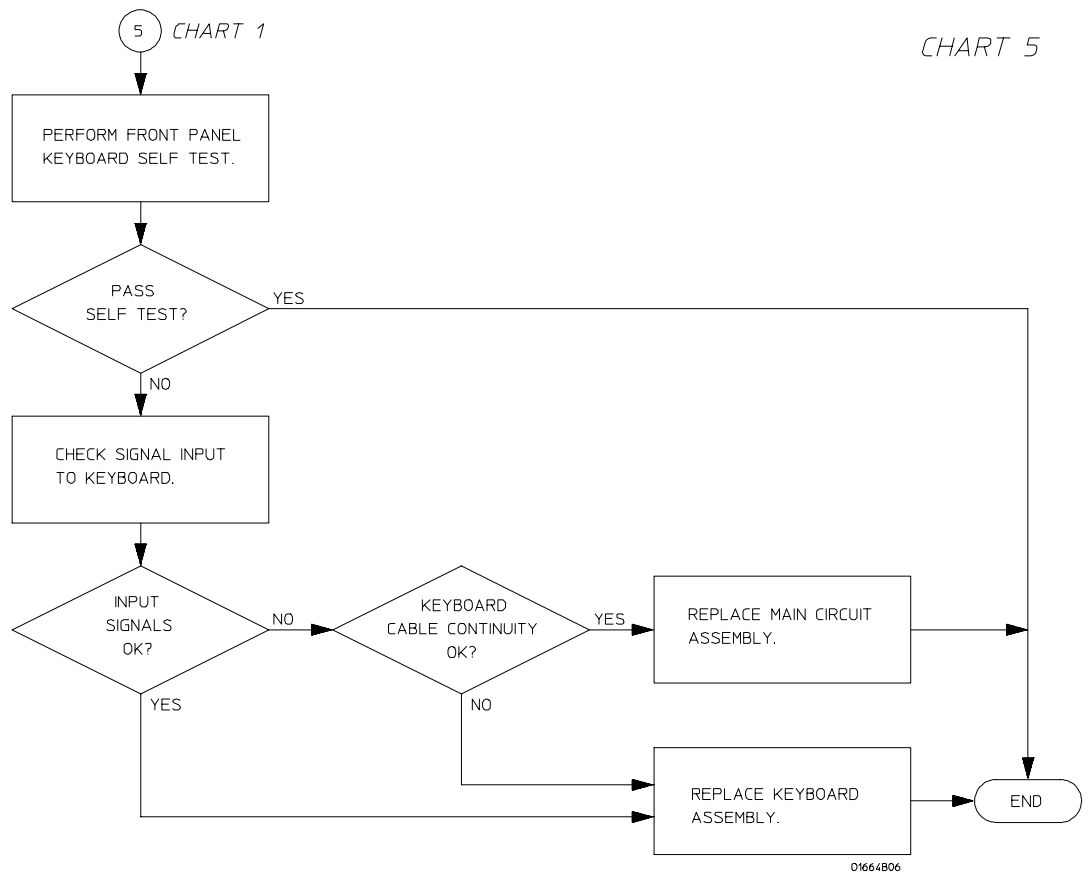

**Troubleshooting Flowchart 5**

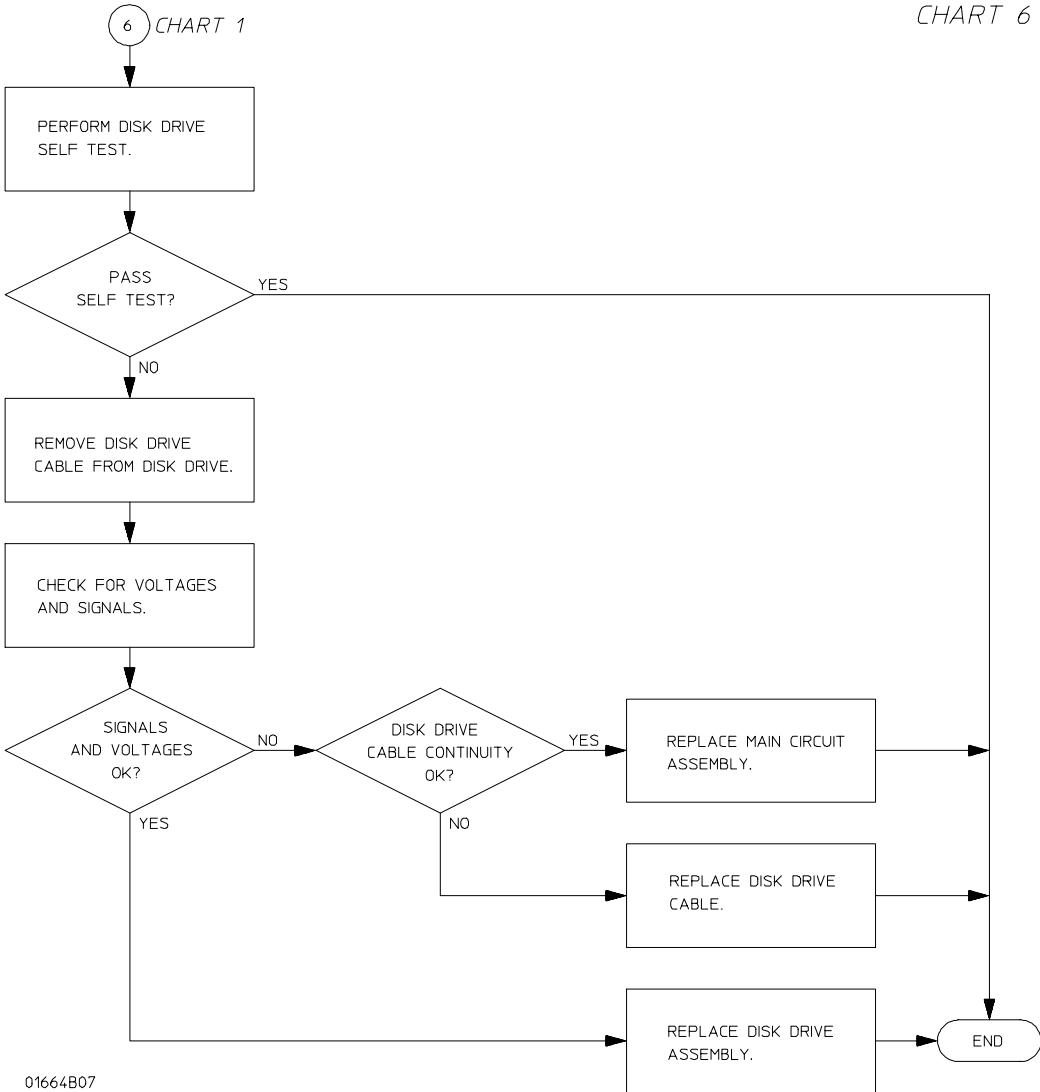

01664B07

Troubleshooting Flowchart 6



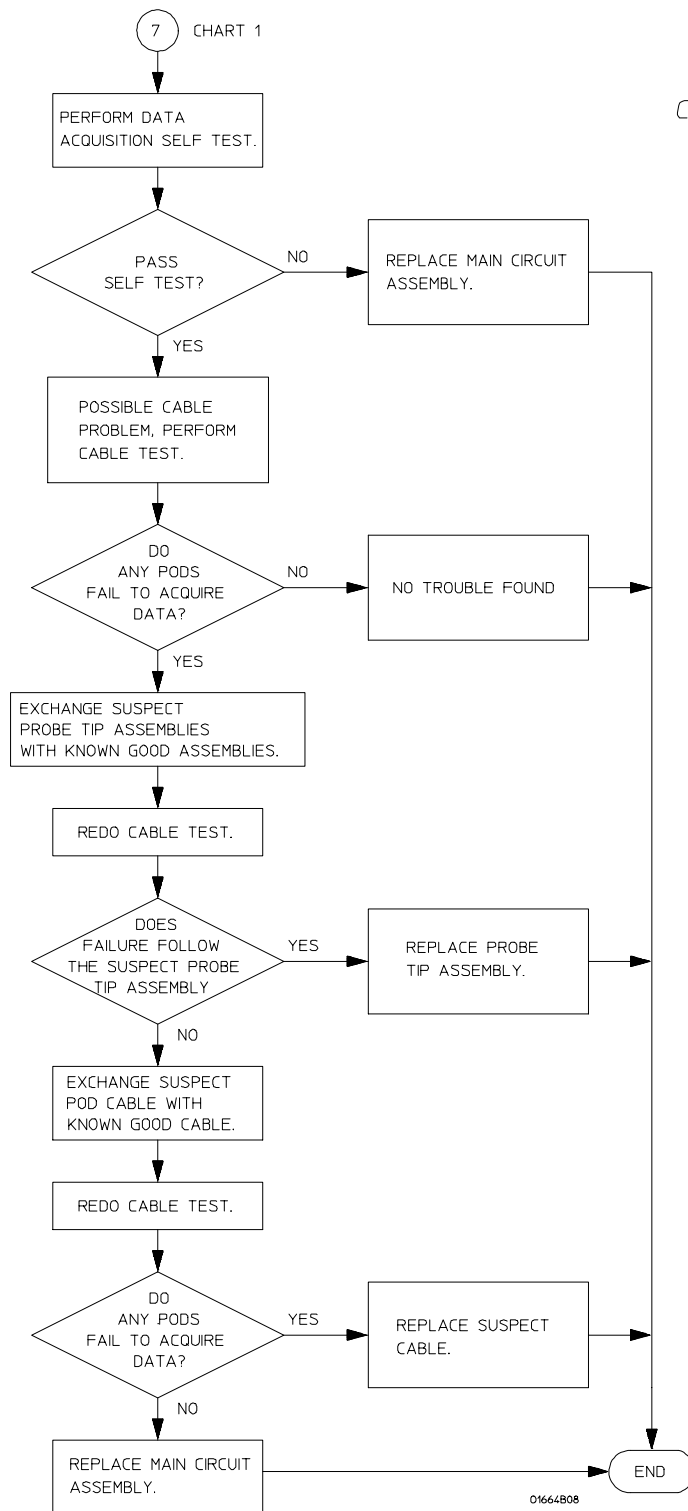

CHART 7

NOTE: VERIFY THAT THERE ARE NO BENT OR BROKEN PINS ON THE SYSTEM BOARD CABLE CONNECTOR.  
HP PART NUMBER 1252-4181

01664808

**Troubleshooting Flowchart 7**



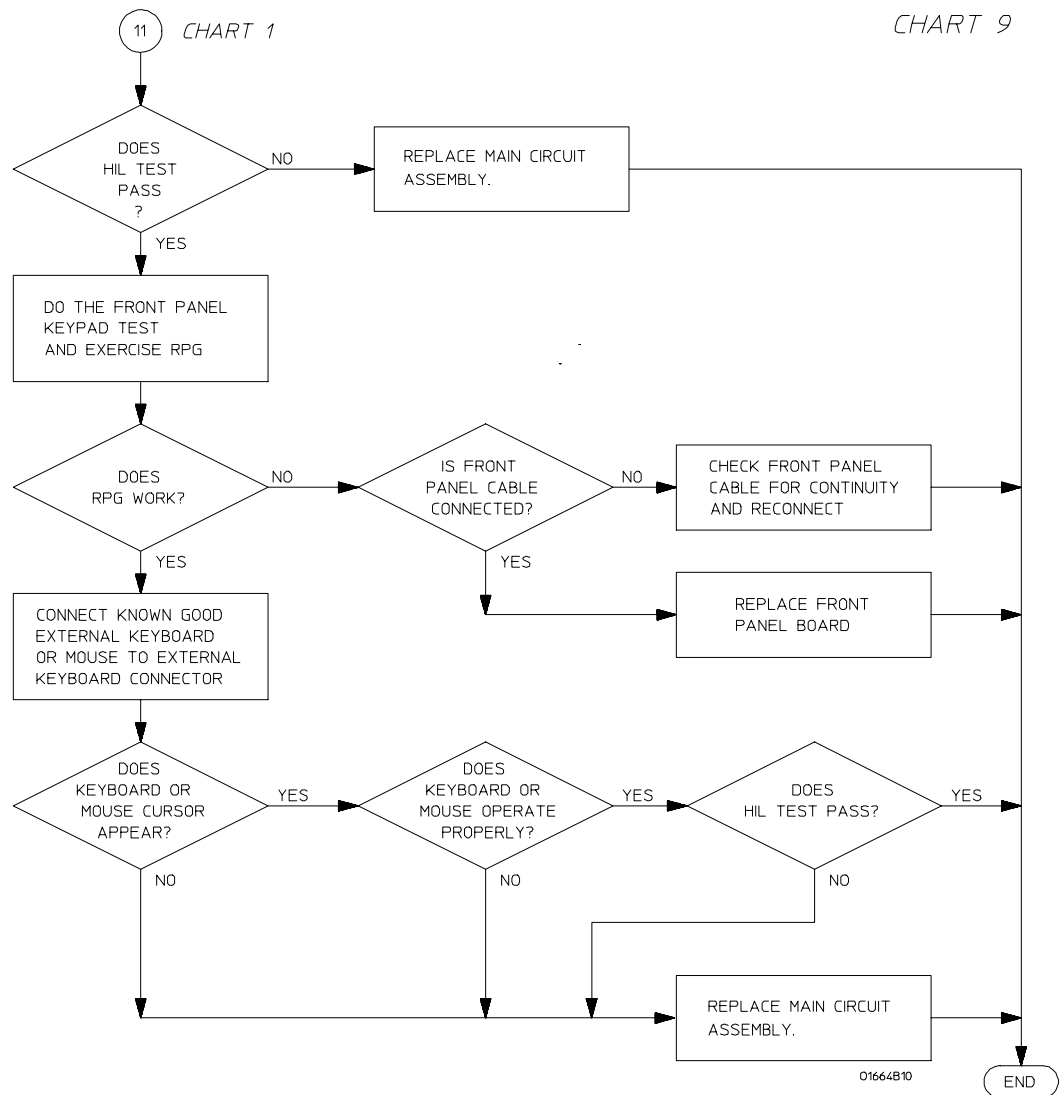

Troubleshooting Flowchart 9

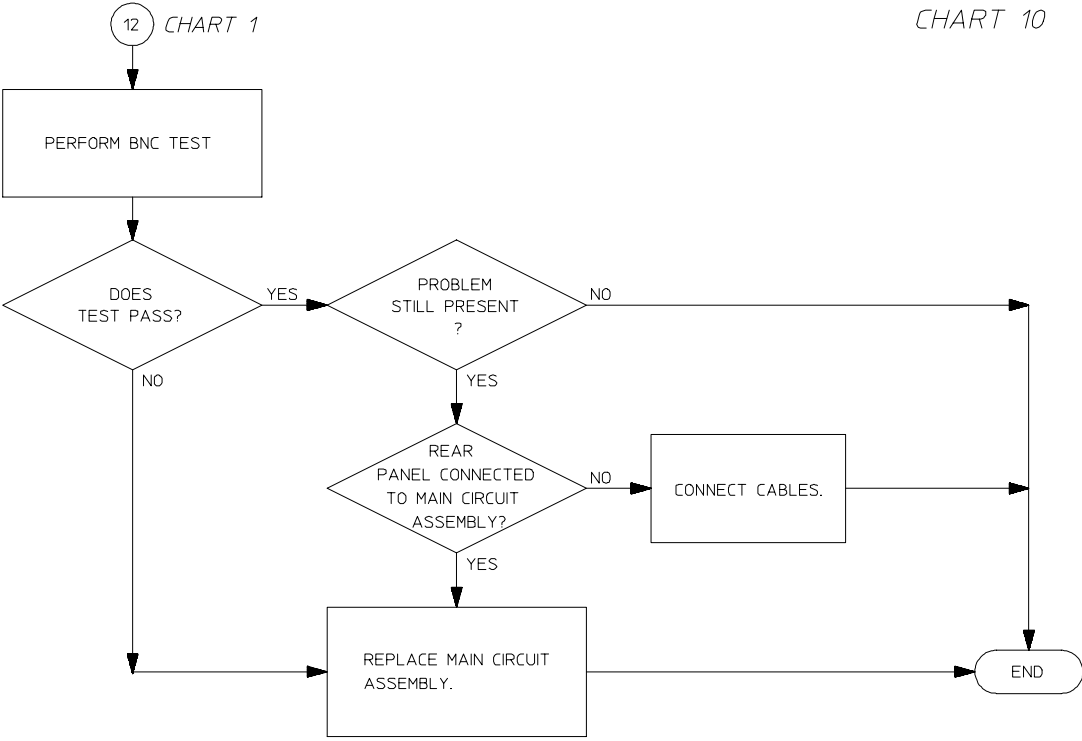

01664B11

**Troubleshooting Flowchart 10**

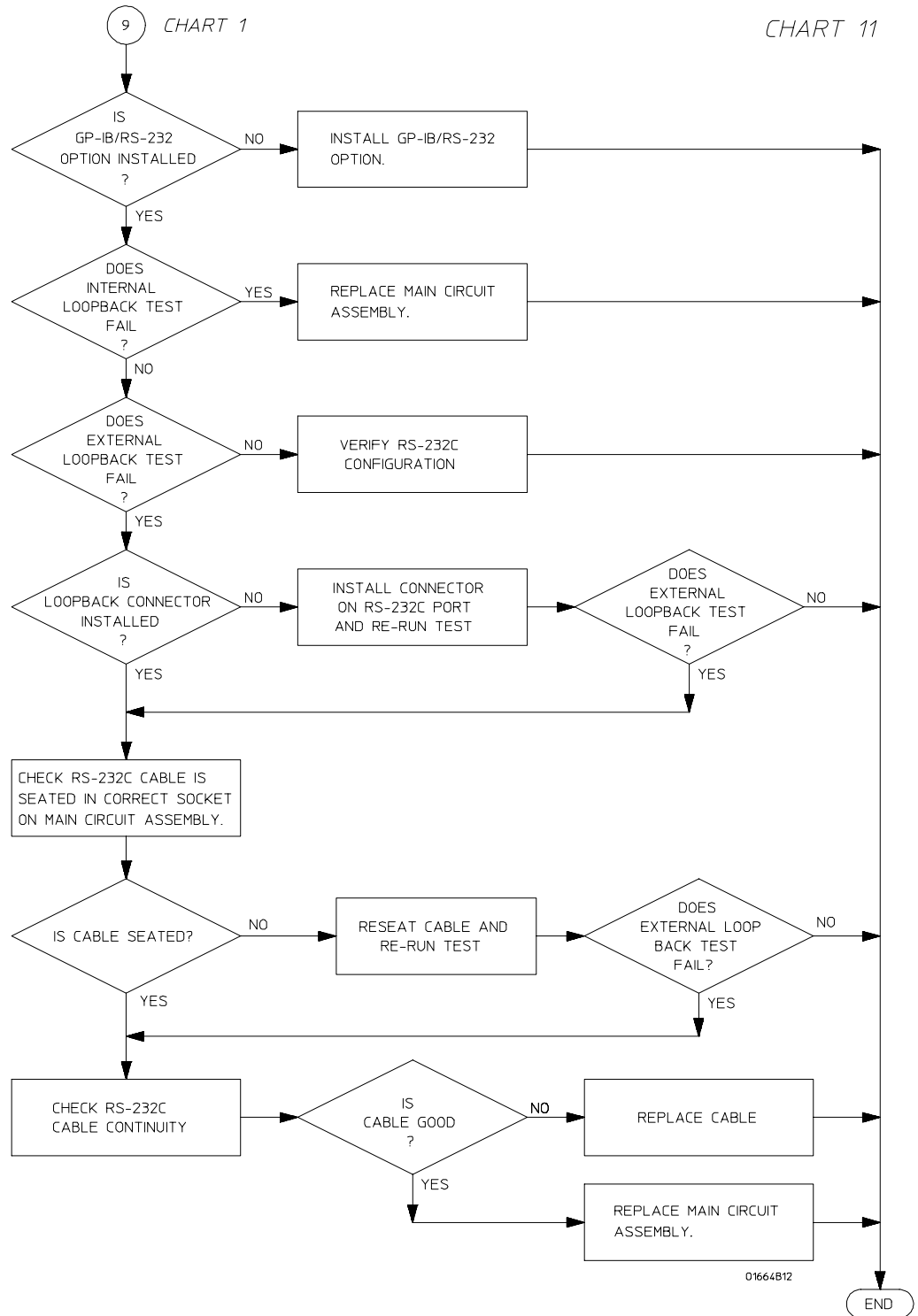

**Troubleshooting Flowchart 11**

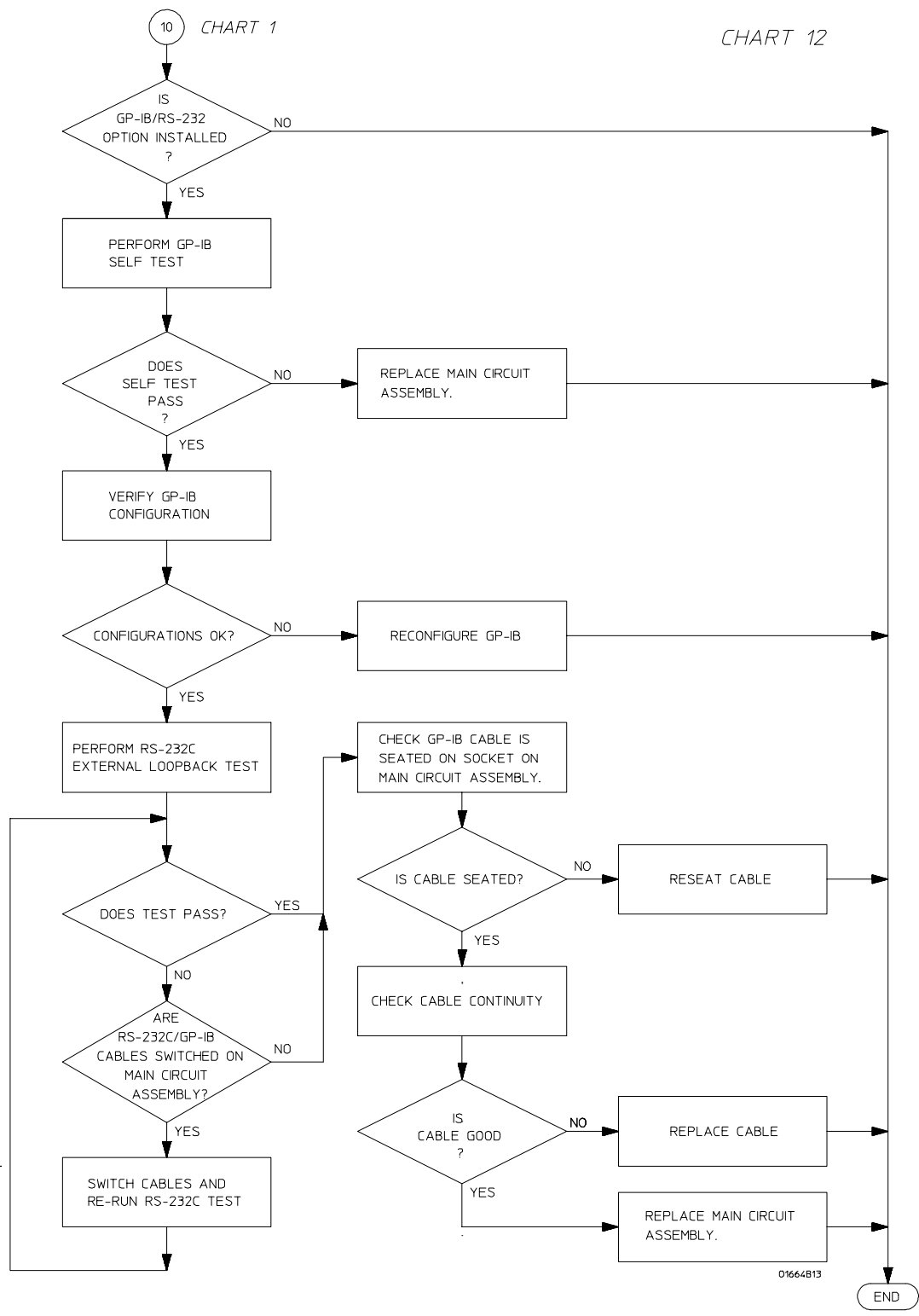

**Troubleshooting Flowchart 12**

---

## To check the power-up tests

The logic analyzer automatically performs power-up tests when you apply power to the instrument (during the boot-up sequence). The revision number of the operating system shows in the upper-right corner of the screen during these power-up tests. As each test completes, either "passed" or "failed" prints on the screen in front of the name of each test.

- 1 Disconnect all inputs, then insert the operating system disk into the disk drive.
- 2 Let the instrument warm up for a few minutes, then cycle power by turning off then turning on the power switch.

If the instrument is not warmed up, the power-up test screen will complete before you can view the screen.

- 3 As the tests complete, check if they pass or fail.

### Performing Power-Up Self-Tests

passed	ROM test
passed	RAM test
passed	Interrupt test
passed	Display test
passed	HIL Controller test
passed	HIL Devices test
No Disk	Front Disk test

## To run the self-tests

Self-tests identify the correct operation of major functional areas of the instrument. You can run all self-tests without accessing the interior of the instrument. If a self-test fails, the troubleshooting flowcharts instruct you to change a part of the instrument.

- 1 If you just did the power-up self-tests, go to step 2.

If you did not just do the power-up self-tests, disconnect all inputs, insert the operating system disk, then turn on the power switch. Wait until the power-up tests are complete.

- 2 Press the System key, then select the field next to System. Select Test in the pop-up menu and then press the Select key.

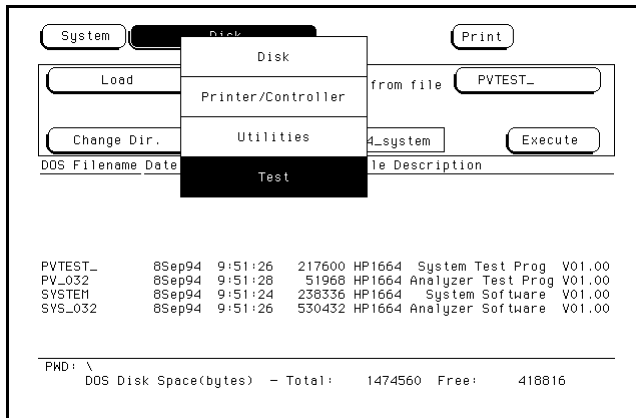

- 3 Select the box labeled Load Test System then press the select key. Insert the disk containing the performance verification tests (self-tests) into the disk drive (normally the same as the boot disk).

- 4 Select the box labeled Continue and press the Select key. After the test files have been loaded, and Analy menu is displayed.

You can run all the analyzer tests at one time by selecting All Analyzer Tests. To see more details about each test, you can run each test individually.

- 5 Select the Chip 5 Tests menu and press the Select key.

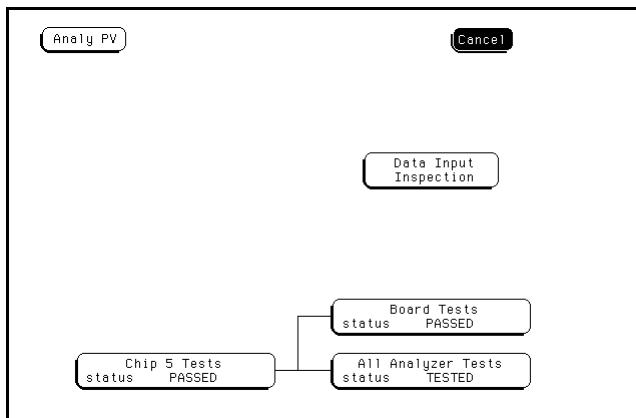



- 6** Select Run, then select Single. The test runs one time, then the screen shows the results. When the test is finished, select Done.

To run a test continuously, select Repetitive. Select Stop to halt a Run Repetitive.

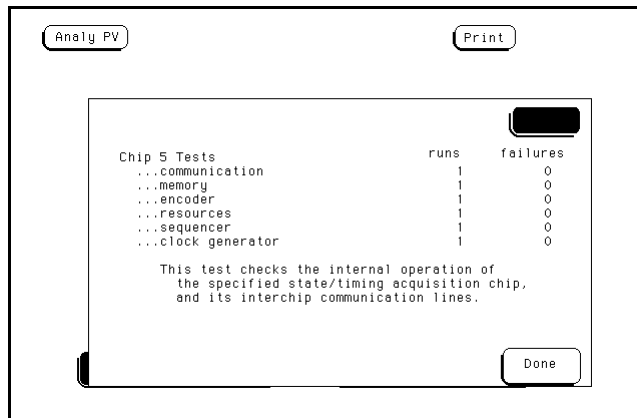

- 7** Select Board Tests, then select Run. When the Board Tests are finished, select Done.

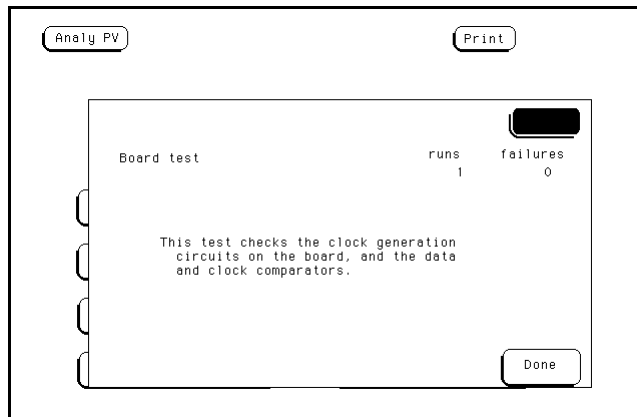

- 8** Select Data Input Inspection. All lines should show activity. Select Done to exit the Data Input Inspection.

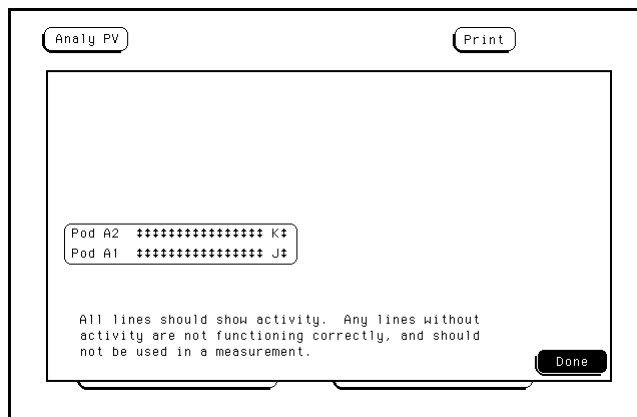

- 9** Select Analy PV, then select Sys PV PV in the pop up menu and press the Select key.

- 10** Select the Printer/Controller field next to Sys PV. Select System Test and press the Select key to access the system tests.

You can run all tests at one time by running All System Tests. To see more details about each test, you can run each test individually. This example shows how to run an individual test.

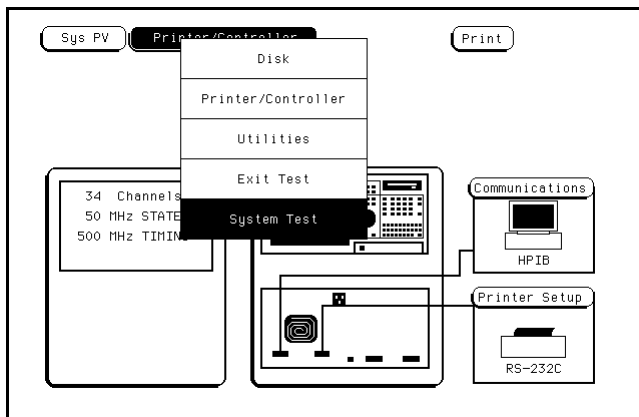

- 11** Select ROM Test. The ROM Test screen is displayed.

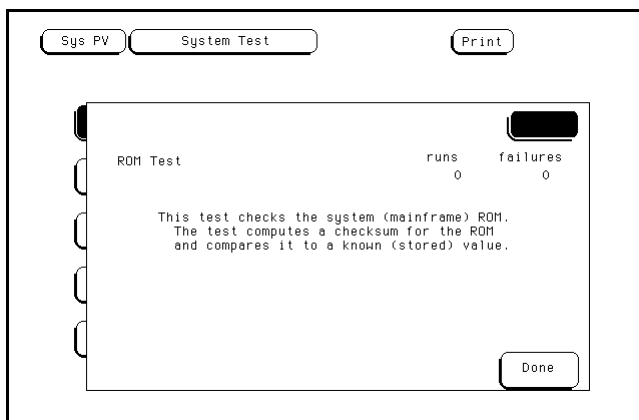

- 12** Select Run, then select Single.

To run a test continuously, select Repetitive. Select Stop to halt a repetitive test.

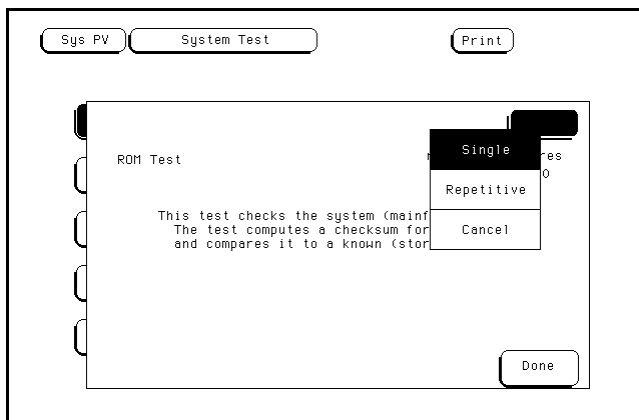

For a Single run, the test runs one time, and the screen shows the results.

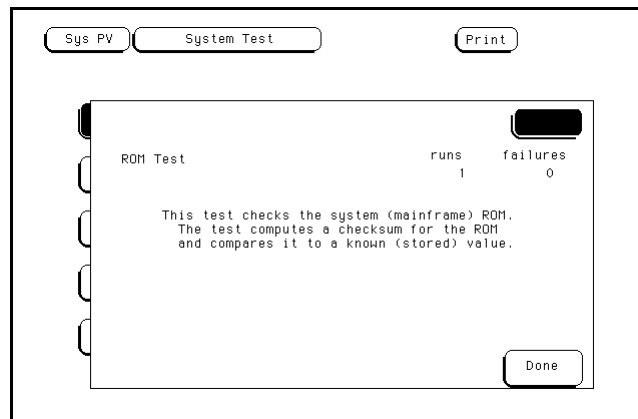

- 13** To exit the ROM Test, select Done. Note that the status changes to Passed or Failed.

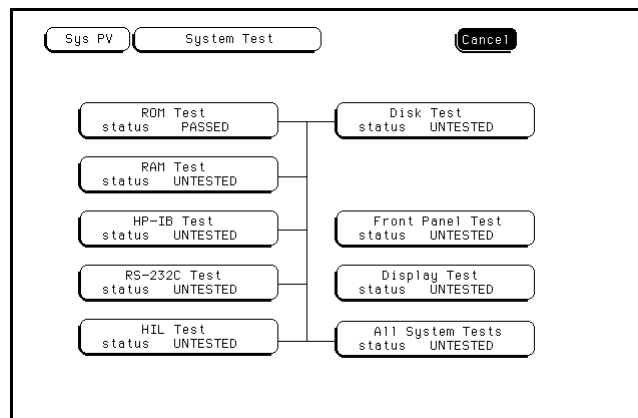

- 14** Install a formatted disk that is not write protected into the disk drive. If option 020 is installed, connect an RS-232C loopback connector onto the RS-232C port. Run the remaining System Tests in the same manner.

If option 020 is not installed in the 1664A, the RS-232C test will return a FAILED status.

- 15** Select the Front Panel Test.

A screen duplicating the front-panel appears on the screen.

- a** Press each key on the front panel. The corresponding key on the screen will change from a light to a dark color.
- b** Test the knob by turning it in both directions.
- c** Note any failures, then press the Done key a second time to exit the Front Panel Test. The test screen shows the Front Panel Test status changed to Tested.

- 16** Select the Display Test.

A white grid pattern is displayed. These display screens can be used to adjust the display.

- a** Select Continue and the screen changes to full bright.
- b** Select Continue and the screen changes to half bright.
- c** Select Continue and the test screen shows the Display Test status changed to Tested.

- 17** To exit the tests, press the System key, then select Exit Test in the pop-up menu and press the select key. Reinstall the disk containing the operating system, then select Exit Test System and press the select key.

If you are performing the self-tests as part of the troubleshooting flowchart, return to the flowchart.

## To test the power supply voltages

To check the voltages, the power supply must be loaded by either the acquisition board or with an added resistor.

Refer to chapter 6, "Replacing Assemblies," for instructions to remove or replace covers and assemblies.

### WARNING

Hazard voltages exist on the power supply, the CRT, and the CRT driver board. This procedure is to be performed by service-trained personnel aware of the hazards involved, such as fire and electrical shock.

#### Loaded by the acquisition board

- 1 Turn off the instrument, then remove the power cable. Remove the cover of the instrument.
- 2 Connect the power plug, then turn on the instrument.
- 3 Check for the +5 V, as indicated by the figure below.

#### Loaded by the added resistor

- 1 Turn off the instrument, then remove the power cable. Remove the cover of the instrument and the disk drive assembly.
- 2 Remove the power supply far enough to disconnect the power supply cable from the acquisition board. Bring the end of the cable up and out of the instrument.

Use the disconnected cable to load the supply and to make measurements.

- 3 Load the +5.00 V supply with a 2  $\Omega$ , 25 watt resistor.
  - a With a jumper wire, connect one end of the resistor to one of the 5.00 V pins (pins 1 through 4) on the supply cable.
  - b With another jumper wire, connect the other end of the resistor to one of the ground pins (pins 5 through 7) on the supply cable.
- 4 Connect the power plug, then turn on the instrument.
- 5 Check for the +5 V as indicated by the figure below.

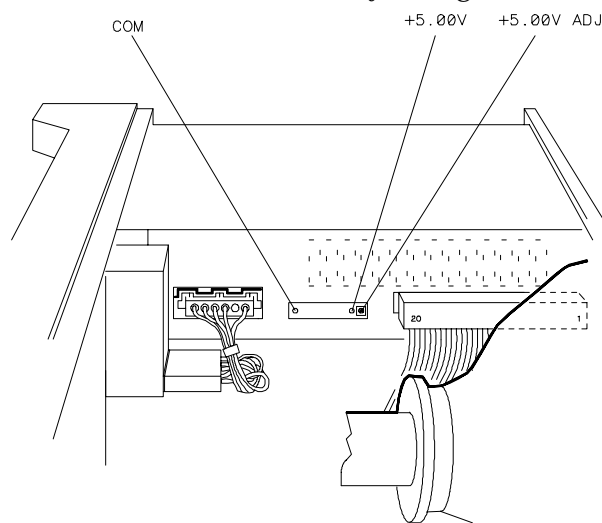

01660E23

Troubleshooting  
**To test the power supply voltages**

**6** Check for the voltages on the power supply cable using the values in the following table.

**Signals on the Power Supply Cable**

Pin	Signal	Pin	Signal
1	+5.00 V	11	-5.20 V
2	+5.00 V	12	Ground
3	+5.00 V	13	+12 V
4	+5.00 V	14	Ground
5	Ground (Digital)	15	-12 V
6	Ground (Digital)	16	Ground
7	Ground (Digital)	17	+12 V (Display)
8	Ground (Display)	18	-5.20 V
9	+3.50 V	19	+15 V (Fan)
10	Ground	20	Ground (Fan)

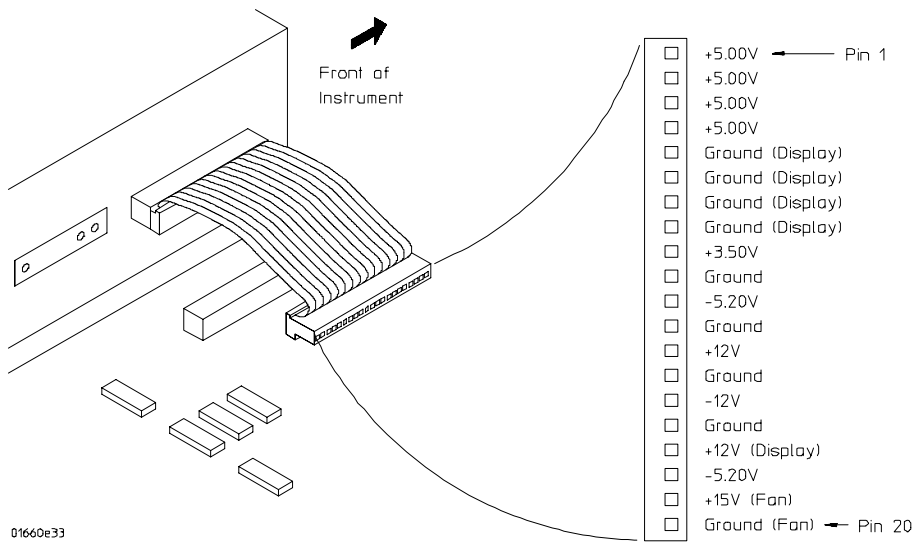

## To test the CRT monitor signals

Refer to chapter 6, "Replacing Assemblies," for instructions to remove or replace covers and assemblies.

### WARNING

Hazard voltages exist on the power supply, the CRT, and the CRT driver board. This procedure is to be performed by service-trained personnel aware of the hazards involved, such as fire and electrical shock.

- 1 Remove the cover of the instrument.
- 2 Check the CRT monitor input cable for the signals and the power supplies listed in the table below. The cable is the wide ribbon cable connecting the monitor to the acquisition board.

### CRT Monitor Cable Signals

Pin	Signal	Pin	Signal
1	NC	2	+12 V
3	Ground	4	Ground
5	+12 V	6	Ground
7	+12 V	8	Ground
9	+12 V	10	HSYNC
11	VSYNC	12	+12 V
13	Ground	14	Ground
15	Ground	16	Video
17	Ground	18	NC
19	Ground	20	NC

---

## To test the keyboard signals

Refer to chapter 6, "Replacing Assemblies," for instructions to remove covers and assemblies.

---

### WARNING

Hazard voltages exist on the power supply, the CRT, and the CRT driver board. This procedure is to be performed by service-trained personnel aware of the hazards involved, such as fire and electrical shock.

- 1 Turn off the instrument and remove the power cable.
- 2 Without disconnecting the keyboard cable, follow the keyboard removal procedure to loosen the keyboard. Leave the keyboard in place in front of the instrument.
- 3 Reconnect the power cable, install the operating system disk, then turn on the instrument.
- 4 Run the Front Panel Test, pressing all of the keys.
- 5 If a random key is not operating, then go to the next step.

If a group of keys do not work, then check the keyboard voltages and signals.

---

### Keyboard Connector Signals

Pin	Signal	Pin	Signal
1	Keyboard Return	13	Keyboard Scan
2	"	14	"
3	"	15	"
4	"	16	"
5	"	17	"
6	"	18	"
7	"	19	LED
8	"	20	+5 V
9	Keyboard Scan	21	Ground
10	"	22	Knob
11	"	23	Ground
12	"	24	Knob

- 6 Allow the keyboard assembly to fall forward from the front panel. Separate the elastomeric keypad and keyboard panel from the PC board.
- 7 Using a paper clip or screwdriver, short the PC board trace of the non-operating key and look for an appropriate response on the display.
- 8 If the display responds as if the key were pressed, replace the elastomeric keypad. If the display does not respond as if the key were pressed, replace the keyboard.
- 9 Check the RPG connector.

The RPG connector has a TTL pulse on pins 22 and 24 when the knob is being turned. Pin 20 of the connector is +5 V.



## To test the disk drive voltages

Refer to chapter 6, "Replacing Assemblies," for instructions to remove or replace covers and assemblies.

### WARNING

This procedure is to be performed by service-trained personnel aware of the hazards involved, such as fire and electrical shock.

### Equipment Required

Equipment	Critical Specification	Recommended Model/Part
Digitizing Oscilloscope	> 100 MHz Bandwidth	Agilent 54600A

- 1 Turn off the instrument, then remove the power cable. Remove the instrument cover and the disk drive.
- 2 Reconnect the disk drive cable to the rear of the disk drive. Turn the disk drive over so that the solder connections of the cable socket are accessible.
- 3 Connect the power cable, insert the operating system disk, then turn on the instrument.
- 4 Insert the disk that contains the functional performance verification software and enter the test operating system.
- 5 In the Sys PV menu select the Disk test. Insert a disk that has enough available bytes to run the test in the disk drive, then select Run-Repetitive.

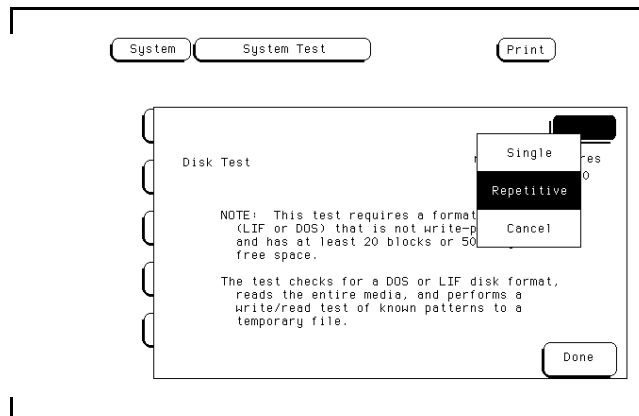

**6** Check for the following voltages and signals using an oscilloscope.

**Disk Drive Voltages**

Pin	Signal Description	Pin	Signal Description
1	NC	2	Disk Change
3	NC	4	High Density
5	NC	6	NC
7	+5 V	8	Index
9	+5 V	10	Drive Select
11	+5 V	12	NC
13	Ground	14	NC
15	Ground	16	Motor On
17	Ground	18	Direction
19	Ground	20	Step
21	Ground	22	Write Data
23	Ground	24	Write Gate
25	Ground	26	Track 00
27	Ground	28	Write Protect
29	Ground	30	Read Data
31	Ground	32	Side Select
33	Ground	34	Ready

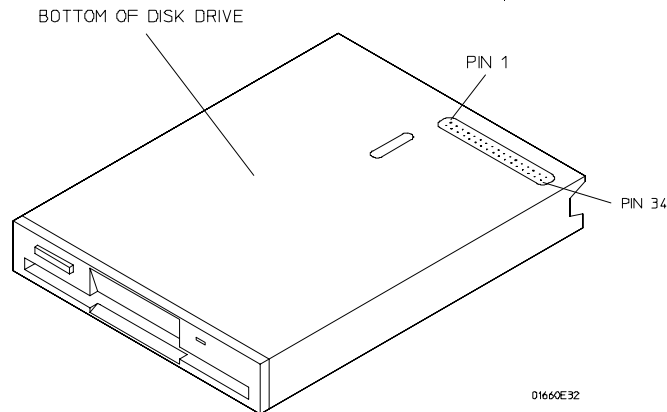

- 7** Select Stop, and turn off the logic analyzer. Remove the power cable.
- 8** Disconnect the disk drive cable and re-install the disk drive in the logic analyzer.
- 9** Reconnect the disk drive cable and install the cover on the logic analyzer.

---

## To perform the BNC test

---

### Equipment Required

---

Equipment	Critical Specification	Recommended Model/Part
Digitizing Oscilloscope	100 MHz Bandwidth	Agilent 54600A
BNC Shorting Cap		1250-0074
BNC Cable		Agilent 10503A
BNC-Banana Adapter		1251-2277

- 1** Press the Config key.
- 2** Assign pods 1 and 2 to Machine 1.  
To assign the pod field, select the pods 1 and 2 field, then select Machine 1 in the pop-up menu.
- 3** In the Analyzer 1 box, select the Type field. Select Timing in the pop-up menu.
- 4** Set up the trigger menu.
  - a** Press the Trig key. Select Clear Trigger All.
  - b** Select Arming Control. In the Arming Control pop-up menu, select the field labeled Run, then select Port In. Press the Done key.
- 5** Attach a BNC shorting cap to the External Trigger Input on the rear panel of the logic analyzer.
- 6** Using a BNC cable, connect the External Trigger output to the oscilloscope channel 1 input. Set the oscilloscope to Trigger On and measure TTL voltage levels.
- 7** Press the RUN front panel key.  
The warning "MACHINE 1 Waiting on level 1" will appear.
- 8** Remove the shorting cap from the rear panel External Trigger input BNC.
- 9** The warning will go away and the oscilloscope will display a positive-going TTL pulse.

## To test the logic analyzer probe cables

This test allows you to functionally verify the probe cable and probe tip assembly of any of the logic analyzer pods. Only one probe cable can be tested at a time. Repeat this test for each probe cable to be tested.

### Equipment Required

Equipment	Critical Specification	Recommended Model/Part
Pulse Generator	100 MHz, 3.5 ns pulse width, < 600 ps rise time	Agilent 8131A Option 020
Adapter (Qty 4)	SMA (m) - BNC (f)	Agilent 1250-1200
Coupler (Qty 4)	BNC (m)(m)	Agilent 1250-0216
6x2 Test Connectors (Qty 4)		

- 1 Turn on the equipment required. Insert the operating system disk and turn on the logic analyzer.
- 2 Set up the pulse generator.
  - a Set up the pulse generator according to the following table.

### Pulse Generator Setup

Channel 1	Channel 2	Period
Delay: 0 ps	Delay: 0 ps	100 ns
Dty: 50%	Dty: 50%	
High: 3.00 V	High: 3.00 V	
Low: 0.00 V	Low: 0.00 V	

- b Enable the pulse generator channel 1 and channel 2 outputs (with the LEDs off).
- 3 Set up the logic analyzer Configuration menu.
  - a Press the Config key.
  - b In the Analyzer 1 box, select the field to the right of Type, then select State.

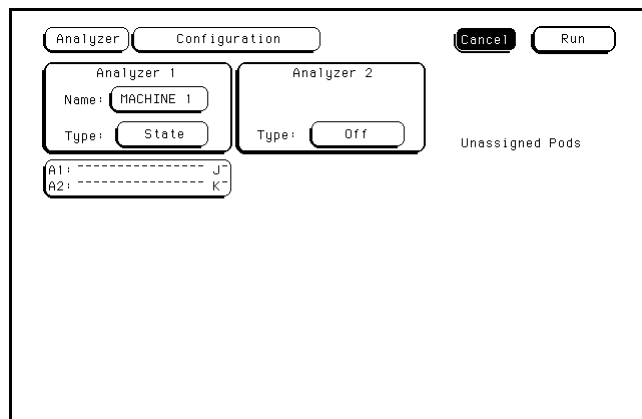

**4** Set up the Format menu.

- a** Press the Format key.
- b** Move the cursor to the field showing the channel assignments for the pod under test. Press the Clear Entry key until the pod channels are all assigned (all asterisks (\*)). Press the Done key.

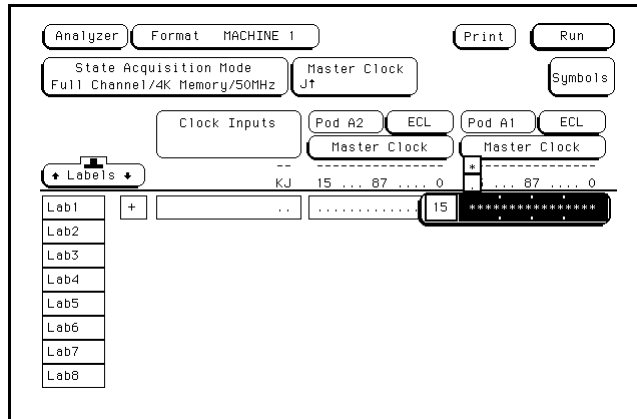

- c** Select Master Clock, then select a double edge for the clock of the pod under test. Turn off the other clocks.

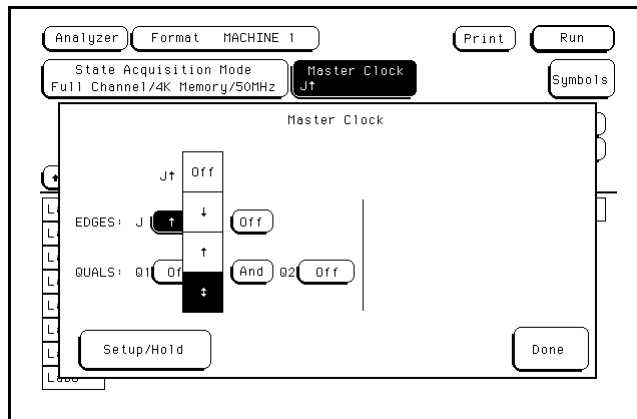

- d** In the Master Clock menu, select Setup/Hold, then select 4.0/0.0 ns for the pod being tested. Select Done. Select Done again to exit the Master Clock menu.

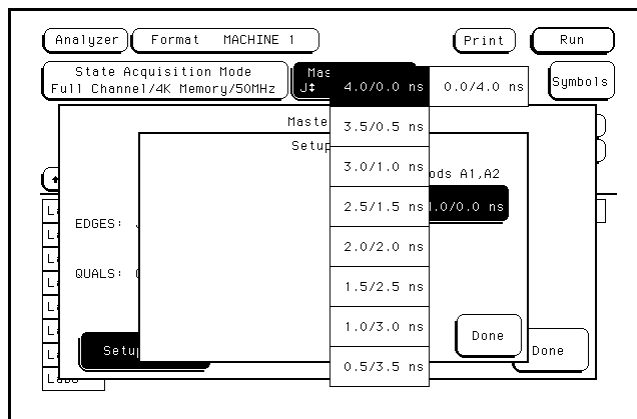

Troubleshooting  
**To test the logic analyzer probe cables**

**e** Select the field to the right of the pod being tested, then select TTL.

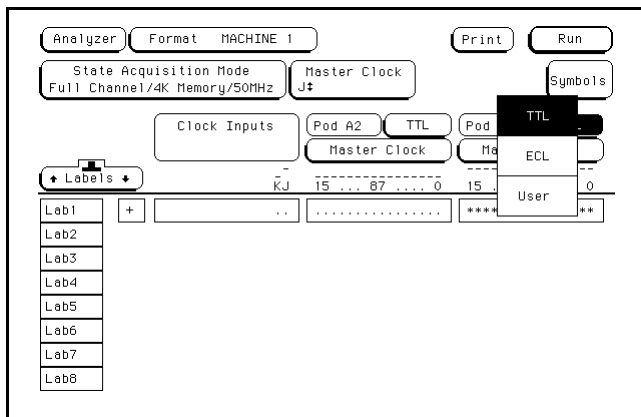

**5** Set up the Trigger menu.

**a** Press the Trigger key.

**b** Select Clear Trigger, then select All.

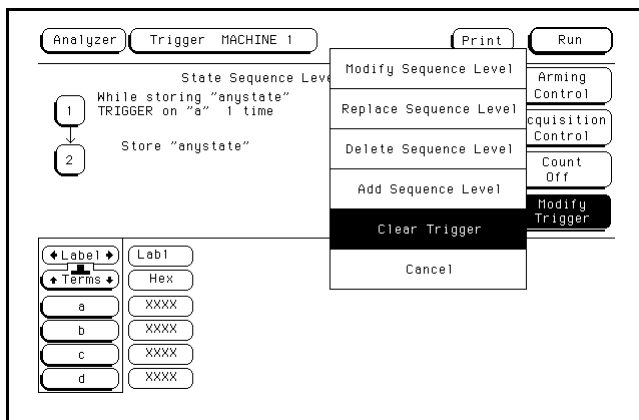

**6** Set up the Listing menu.

**a** Press the List key.

**b** Select the field to the right of Base, then select Binary.

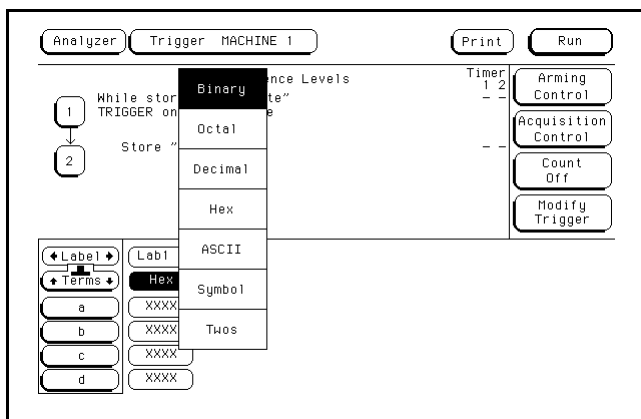

- 7 Using four 6-by-2 test connectors, four BNC Couplers, and four SMA (m) - BNC (f) Adapters, connect the logic analyzer to the pulse generator channel outputs. To make the test connectors, see chapter 3, "Testing Performance."
  - a Connect the even-numbered channels of the lower byte of the pod under test to the pulse generator channel 1 Output and J-clock.
  - b Connect the odd-numbered channels of the lower byte of the pod under test to the pulse generator channel 1  $\overline{\text{Output}}$ .
  - c Connect the even-numbered channels of the upper byte of the pod under test and the clock channel to the pulse generator channel 2 Output.
  - d Connect the odd-numbered channels of the upper byte of the pod under test to the pulse generator channel 2  $\overline{\text{Output}}$ .
- 8 On the logic analyzer, press Run. The display should look similar to the figure below.

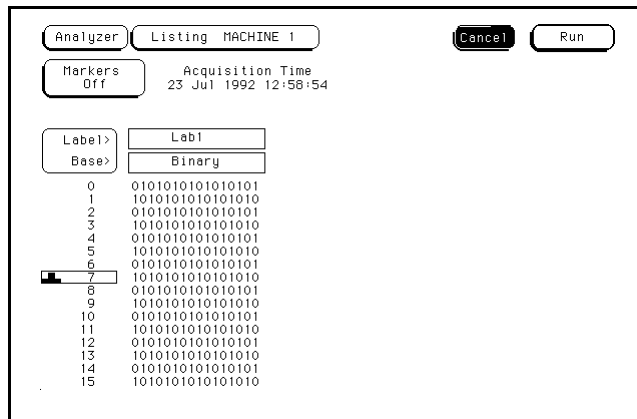

- 9 If the display looks like the figure, then the cable passed the test.  
If the display does not look similar to the figure, then there is a possible problem with the cable or probe tip assembly. Causes for cable test failures include the following:

- open channel.
- channel shorted to a neighboring channel.
- channel shorted to either ground or a supply voltage.

Return to the troubleshooting flowchart.

---

## To test the auxiliary power

The +5 V auxiliary power is protected by a current overload protection device. If the current on pins 1 and 39 exceed 0.33 amps, the circuit will open. When the short is removed, the circuit will reset in approximately 1 minute. There should be +5 V after the 1 minute reset time.

---

### Equipment Required

---

Equipment	Critical Specifications	Recommended Model/Part
Digital Multimeter	0.1 mV resolution, better than 0.005% accuracy	Agilent 3478A

- Using the multimeter, verify the +5 V on pins 1 and 39 of the probe cables.

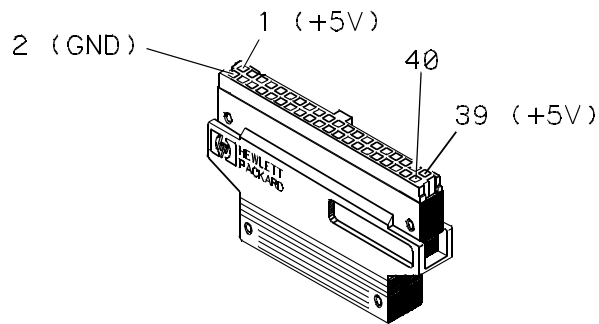

MISC/EX50



To remove and replace the

- Handle 6-5
- Feet and tilt stand 6-5
- Cover 6-5
- Disk drive 6-6
- Power supply 6-7
- Main circuit board 6-7
- Switch actuator assembly 6-8
- Rear panel assembly 6-9
- Front panel and keyboard 6-10
- Intensity adjustment 6-10
- Monitor 6-11
- Handle plate 6-11
- Fan 6-12
- Line filter 6-12
- Optional GPIB and/or RS-232C cables 6-13

To return assemblies 6-14

---

## Replacing Assemblies

---

# Replacing Assemblies

This chapter contains the instructions for removing and replacing the assemblies of the logic analyzer. Also in this chapter are instructions for returning assemblies.

---

**WARNING**

Hazardous voltages exist on the power supply, the CRT, and the CRT driver board. To avoid electrical shock, disconnect the power from the instrument before performing the following procedures. After disconnecting the power, wait at least three minutes for the capacitors on the power supply board and the CRT driver board to discharge before servicing the instrument.

---

**CAUTION**

Damage can occur to electronic components if you remove or replace assemblies when the instrument is on or when the power cable is connected. Never attempt to remove or install any assembly with the instrument on or with the power cable connected.

## Replacement Strategy

These replacement procedures are organized as if disassembling the complete instrument, from the first assembly to be removed to the last. Some procedures say to remove other assemblies of the instrument, but do not give complete instructions. Refer to the procedure for that specific assembly for the instructions. Use the exploded view of the instrument on the next page as a reference during the replacement procedures.

---

**CAUTION**

Electrostatic discharge can damage electronic components. Use grounded wriststraps and mats when performing any service to this logic analyzer.

## Tools Required

- #10 TORX screwdriver
- #15 TORX screwdriver
- #1 Posidrive screwdriver
- 3/16 inch (5 mm) nut driver
- 9/32 inch (7 mm) nut driver

## Exploded View

### Listing

A1	Main circuit board	MP3	Fan guard	MP32	Spacer
A2	Keyboard	MP4	Rear panel	MP33	Label
A3	Switch actuator	MP5	Line filter		
A4	Probe cable	MP6	Handle plate	W1	Fan cable
A5	Probe tip	MP7	Ground bracket	W2	Disk drive cable
A6	Power supply	MP8	Cabinet	W3	Jumper cable-orange
A7	Disk drive	MP9	Cover	W4	Jumper cable-white
A8	Monitor assembly	MP15	Rear feet	W5	Power supply cable
A9	Fan	MP18	Mounting plate	W6	Front panel cable
		MP19	Insulator	W7	Monitor sweep cable
H2	Ground spring	MP20	Trim strip	W8	GPIB cable
H3	Locking pin	MP21	Label	W9	RS-232C cable
H4	BNC connector	MP22	Label		
H22	Cable retaining screw	MP23	Elastomeric keypad		
		MP24	RPG knob		
MP1	Intensity adjustment	MP25	Keyboard panel		
MP2	Disk drive bracket	MP26	Keyboard spacer		

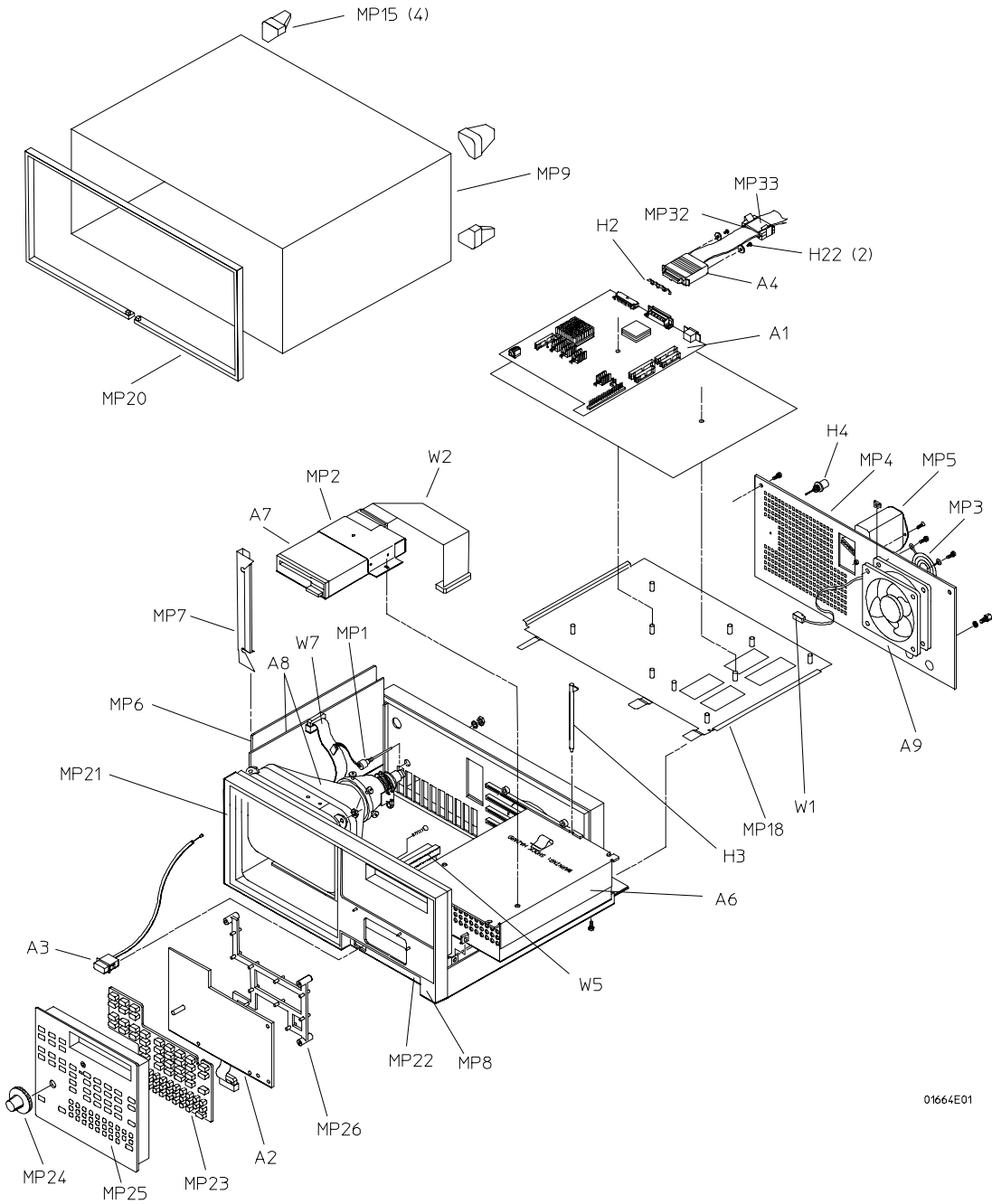

01664E01

**Exploded View of the 1664A**

---

## To remove and replace the handle

- Remove the two screws in the endcaps, then lift off the handle.

---

## To remove and replace the feet and tilt stand

- 1 Remove the screws connecting the four rear feet to the instrument.
- 2 Separate the rear feet from the instrument to remove them.
- 3 Press the locking tab on the bottom feet, then remove them.
- 4 Remove the tilt stand from the bottom front feet by lifting the stand up and out of the foot.
- 5 Reverse this procedure to install the feet and tilt stand.

---

## To remove and replace the cover

- 1 Disconnect the logic analyzer cables from the rear panel.
- 2 Using the previous procedures, remove the handle and the four rear feet.
- 3 Remove the seven screws from the front molding, then slide the molding forward to remove it.
- 4 Remove the cover.

To remove the cover, set the instrument upright and facing toward you. Slide the chassis toward the front, out of the cover, and set it on a static-safe work area.

- 5 Reverse this procedure to install the cover.

Check that all assemblies are properly installed before installing the cover.

When installing the chassis in the cover, check that the tabs located at the bottom, rear of the cover align with the holes in the rear panel.

## To remove and replace the disk drive

**1** Using previous procedures, remove the following assemblies:

- Handle
- Rear Feet
- Cover

**2** Disconnect the disk drive cable from the rear of the disk drive.

**3** Remove the two screws that attach the disk drive bracket to the power supply.

**4** Slide the disk drive toward the rear of the instrument, then lift it up and out.

**5** Remove the disk drive bracket.

To remove the disk drive bracket, remove the four screws that attach the disk drive bracket to the disk drive.

**6** Reverse this procedure to install the disk drive.

Check that the following assemblies are properly installed before installing the disk drive:

- Monitor
- Front Panel
- Switch Actuator
- Main Circuit Board
- Power Supply

---

## To remove and replace the power supply

**1** Using previous procedures, remove the following assemblies:

- Handle
- Rear Feet
- Cover
- Disk Drive

---

**WARNING**

---

Hazardous voltages exist on the power supply. To avoid electrical shock, disconnect the power from the instrument before performing the following procedures. After disconnecting the power, wait at least three minutes for the capacitors to discharge before servicing the instrument.

**2** Lift the PCB locking pins out of the chassis.

**3** Slide the power supply out far enough to reach the power supply cables, then disconnect them from the power supply.

**4** Slide the power supply the rest of the way out the side of the instrument.

**5** Reverse this procedure to install the power supply.

Check that the following assemblies are properly installed before installing the power supply:

- Monitor
- Front Panel
- Switch Actuator
- Main Circuit Board

---

## To remove and replace the Main Circuit board

**1** Using previous procedures, remove the following assemblies:

- Handle
- Rear Panel
- Cover
- Disk Drive
- Power Supply

**2** Disconnect the GPIB and RS-232C cables from the Main Circuit board.

**3** Disconnect the front panel cable from the Main Circuit board.

**4** Disconnect the monitor board cable from the Main Circuit board.

**5** Slide the board out the rear of the instrument.

**6** Reverse this procedure to install the Main Circuit board.

Check that the following assemblies are properly installed before installing the Main Circuit board:

- Monitor
- Front Panel
- Switch Actuator

---

## To remove and replace the switch actuator assembly

- 1 Using previous procedures, remove the following assemblies:
  - Handle
  - Rear Feet
  - Cover
  - Disk Drive
  - Power Supply
  - Main Circuit board
- 2 Make sure the power switch is in the off position.
- 3 Disconnect the switch actuator from the line filter.
  - a Slide the clamp off of the outer casing far enough to release the switch actuator assembly.

---

### CAUTION

If the wire in the switch actuator is bent, the complete assembly must be replaced. Refer to chapter 5, "Replaceable Parts" for the part number.

- b Without bending the wire, gently pry the nipple out of the switch plunger.
- c Slide the cable out of the switch assembly.

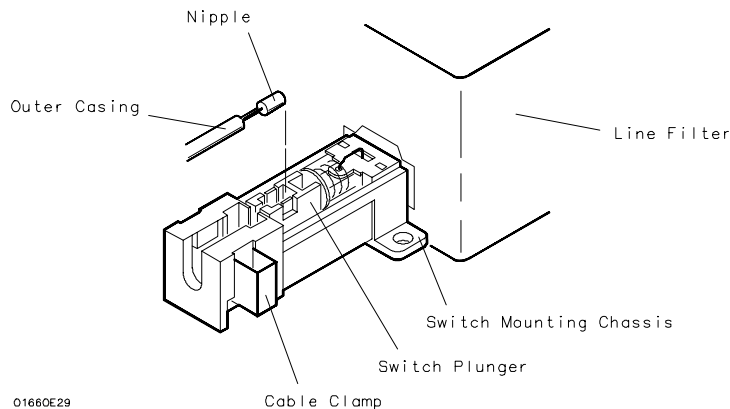

- 4 Remove the switch actuator assembly from the front of the cabinet.

To remove, depress the retaining ears on both sides of the assembly next to the front panel and push the assembly out the front.
- 5 Install the new switch actuator assembly. Make sure that the line filter switch is in the off position.
  - a Route the cable through the front panel, then snap the pushbutton into the front panel.
  - b Snap the nipple into the switch plunger.
  - c Position the free end of the outer casing into the switch mounting chassis. The edge of the outer casing should be all the way against the inner edge of the switch mounting chassis.
  - d Close the clamp by pushing it into the switch assembly until the clamp is seated.
- 6 Verify the push-on, push-off action of the assembly.



## To remove and replace the rear panel assembly

- 1** Using previous procedures, remove the following assemblies:
  - Handle
  - Rear Feet
  - Cover
- 2** Remove the switch actuator cable from the line filter according to "To remove and replace the switch actuator assembly."
- 3** Disconnect the BNC In/Out and fan cables on the Main Circuit board.
- 4** Disconnect the RS-232C and GPIB cables from the Main Circuit board.
- 5** Remove the two standoffs connecting the parallel printer connector socket to the rear panel.
- 6** Remove the two screws connecting the keyboard connector socket to the rear panel.
- 7** Remove the six rear panel screws.
- 8** Lift the rear panel away from the chassis.
- 9** Reverse this procedure to install the rear panel.

Check that the following assemblies are properly installed before installing the rear panel:

- Monitor
- Main Circuit Board

When installing the rear panel, check that the connectors on the main circuit board are lined up with the corresponding holes in the rear panel.

## To remove and replace the front panel and keyboard

**1** Using previous procedures, remove the following assemblies:

- Handle
- Rear Feet
- Cover
- Disk Drive
- Power Supply
- Main Circuit board

**2** Remove the four screws connecting the front panel.

**3** Slide the front panel assembly out the front of the instrument.

**4** Slide the spacers out the front of the instrument to remove them.

Be careful not to lose the copper ground strips on the spacer.

When installing the spacer, insert the pins of the spacer in the appropriate holes in the chassis. You can hold the spacer in place while installing the front panel by holding it with your finger through the disk drive mounting slot in the chassis.

**5** Remove the RPG knob by pulling the knob off the RPG shaft.

**6** Disassemble the front panel assembly by lifting the keyboard circuit board away from the front panel.

**7** Lift the elastomeric keypad out of the front panel.

**8** Reverse this procedure to assemble and install the front panel assembly.

When assembling the front panel, check that the holes in the elastomeric keypad and the keyboard circuit board align with the pins on the front panel.

---

## To remove and replace the intensity adjustment

**1** Using previous procedures, remove the following assemblies:

- Handle
- Rear Feet
- Cover
- Rear Panel

**2** Disconnect the intensity adjustment cable from the CRT driver board.

**3** Using a nut driver, remove the hex nut attaching the intensity adjustment to the chassis.

**4** Slide the intensity adjustment assembly toward the front and up out of the instrument.

**5** Reverse this procedure to install the intensity adjustment.

When installing the intensity adjustment, check that the keying tab on the adjustment aligns with the keying hole in the chassis.

---

---

## To remove and replace the monitor

**1** Using previous procedures, remove the following assemblies:

- Handle
- Rear Feet
- Cover
- Disk Drive
- Power Supply
- Main Circuit board
- Rear Panel

---

**WARNING**

Hazardous voltages exist on the CRT and the CRT driver board. To avoid electrical shock, disconnect the power from the instrument before performing the following procedures. After disconnecting the power, wait at least three minutes for the capacitors to discharge before servicing the instrument.

- 2** Disconnect the cable from the rear of the CRT.
- 3** Disconnect the yoke cable and intensity cable from the CRT driver board.
- 4** Disconnect the high voltage lead from the bell of the CRT.
- 5** Slide the CRT driver board up out of the chassis.
- 6** Using a nut driver, remove the three hex nuts attaching the monitor and ground bracket to the chassis, then remove the screw.
- 7** Slide the monitor assembly and ground bracket to the rear and up out of the chassis.
- 8** Reverse this procedure to install the monitor.

When installing the CRT driver board, check that the board is properly inserted in the circuit board tracks.

---

## To remove and replace the handle plate

**1** Using previous procedures, remove the following assemblies:

- Handle
- Rear Feet
- Cover

**2** Remove the four screens that attach the handle plate to the chassis.

**3** Remove the handle plate.

To remove the handle plate, align the plate toward the front of the instrument, then move it up and out of the instrument.

**4** Reverse this procedure to install the handle plate.

## To remove and replace the fan

**1** Using previous procedures, remove the following assemblies:

- Handle
- Rear Feet
- Cover
- Disk Drive
- Power Supply
- Rear Panel

**2** Disconnect the fan cable from the main circuit board.

**3** Remove the four fan screws.

**4** Lift the fan away from the rear panel.

**5** Lift the fan guard away from the rear panel.

**6** Reverse this procedure to install the fan.

When installing the fan, verify the correct orientation of the fan. If you mount the fan backwards, the instrument will overheat. Also, check the correct polarity of the fan cable.

---

## To remove and replace the line filter

**1** Using previous procedures, remove the following assemblies:

- Handle
- Rear Feet
- Cover
- Disk Drive
- Power Supply
- Rear Panel

**2** Unsolder the ground wire from the lug on the rear panel.

**3** Disconnect the line filter cable from the power supply.

**4** Remove the two screws attaching the line filter to the rear panel.

**5** Slide the line filter assembly out toward the rear.

**6** Reverse this procedure to install the line filter.

## To remove and replace the optional GPIB and RS-232C cables

- 1** Using previous procedures, remove the following assemblies:
  - Handle
  - Rear Feet
  - Cover
  - Disk Drive
  - Power Supply
  - Rear Panel
- 2** Disconnect interface cables from the main circuit board.
- 3** Remove the two hex standoffs connecting the GPIB cable, then slide the GPIB cable forward and out of the rear panel.
- 4** Remove the two hex standoffs connecting the RS-232C cable, then slide the RS-232C cable forward and out of the rear panel.
- 5** Reverse this procedure to install the GPIB and RS-232C cables.

## To return assemblies

Before shipping the logic analyzer or assemblies to Agilent Technologies, contact your nearest Agilent Technologies sales office for additional details.

**1 Write the following information on a tag and attach it to the part to be returned.**

- Name and address of owner
- Model number
- Serial number
- Description of service required or failure indications

**2 Remove accessories from the logic analyzer.**

Only return accessories to Agilent Technologies if they are associated with the failure symptoms.

**3 Package the logic analyzer.**

You can use either the original shipping containers, or order materials from an Agilent Technologies sales office.

---

**CAUTION**

---

For protection against electrostatic discharge, package the logic analyzer in electrostatic material.

**4 Seal the shipping container securely, and mark it FRAGILE.**

Replaceable Parts Ordering 7-2  
Exploded View 7-3  
Replaceable Parts List 7-4  
Power Cables and Plug Configurations 7-8

---

## Replaceable Parts

---

# Replaceable Parts

This chapter contains information for identifying and ordering replaceable parts for your logic analyzer.

---

## Replaceable Parts Ordering

### **Parts listed**

To order a part on the list of replaceable parts, quote the Agilent Technologies part number, indicate the quantity desired, and address the order to the nearest Agilent Technologies Sales Office.

### **Parts not listed**

To order a part not on the list of replaceable parts, include the model number and serial number of the module, a description of the part (including its function), and the number of parts required. Address the order to your nearest Agilent Technologies Sales Office.

### **Direct mail order system**

To order using the direct mail order system, contact your nearest Agilent Technologies Sales Office.

Within the USA, Agilent Technologies can supply parts through a direct mail order system. The advantages to the system are direct ordering and shipment from the Agilent Technologies Part Center in Mountain View, California. There is no maximum or minimum on any mail order. (There is a minimum amount for parts ordered through a local Agilent Technologies Sales Office when the orders require billing and invoicing.) Transportation costs are prepaid (there is a small handling charge for each order) and no invoices.

In order for Agilent Technologies to provide these advantages, a check or money order must accompany each order. Mail order forms and specific ordering information are available through your local Agilent Technologies Sales Office. Addresses and telephone numbers are located in a separate document at the back of the service guide.

### **Exchange Assemblies**

Some assemblies are part of an exchange program with Agilent Technologies.

The exchange program allows you to exchange a faulty assembly with one that has been repaired and performance verified by Agilent Technologies.

After you receive the exchange assembly, return the defective assembly to Agilent Technologies. A United States customer has 30 days to return the defective assembly. If you do not return the defective assembly within the 30 days, Agilent Technologies will charge you an additional amount. This amount is the difference in price between a new assembly and that of the exchange assembly. For orders not originating in the United States, contact your nearest Agilent Technologies Sales Office for information.

### **See Also**

"To return assemblies," in chapter 6.



### Exploded View

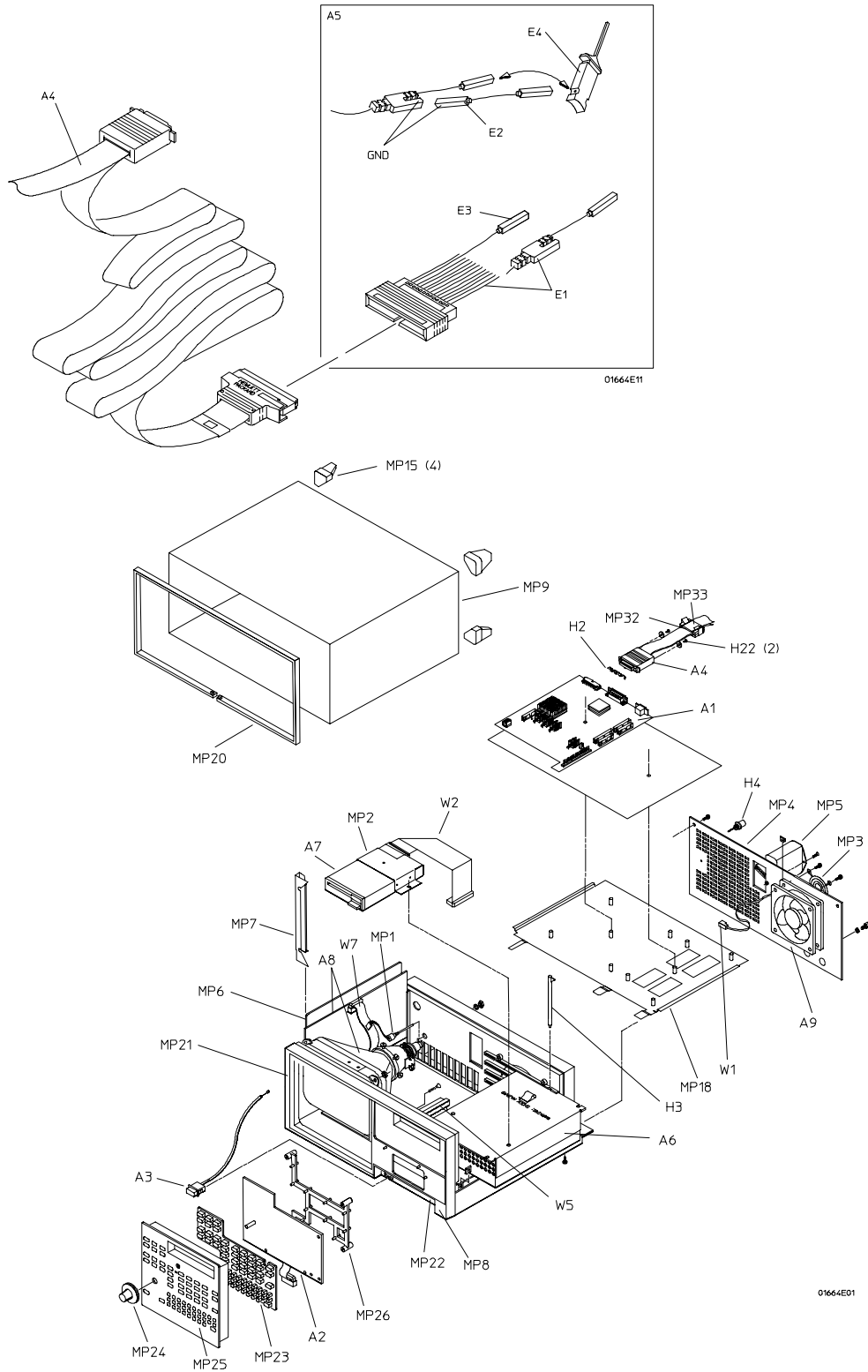

Exploded view of the 1664A logic analyzer.

## Replaceable Parts List

The replaceable parts list is organized by reference designation and shows exchange assemblies, electrical assemblies, then other parts.

The exploded view does not show all of the parts in the replaceable parts list.

Information included for each part on the list consists of the following:

- Reference designator
- Agilent Technologies part number
- Total quantity included with the instrument (Qty)
- Description of the part

Reference designators used in the parts list are as follows:

- A Assembly
- E Miscellaneous Electrical Part
- F Fuse
- H Hardware
- MP Mechanical Part
- W Cable

---

**1664A Replaceable Parts**

---

<b>Ref. Des.</b>	<b>Agilent Part Number</b>	<b>Qty</b>	<b>Description</b>
	01664-69501		Exchange Board Exchange main circuit assembly
			Replacement Parts
A1	01664-66501	1	Main circuit assembly
A2	01660-66502	1	Board assembly-keyboard
A3	01660-61901	1	Switch actuator
A4	01660-61605	1	Probe Cable
A5	01650-61608	2	Probe tip assembly
A6	0950-2261	1	Power supply
A7	0950-2169	1	Disk drive
A8	2090-0304	1	Monitor assembly
A9	3160-0829	1	Fan-tubeaxial
A10	1150-1922	1	Three-button mouse
E1	5959-9333		Replacement probe leads (5 per package)
E2	5959-9334		Replacement probe grounds (5 per package)
E3	5959-9335		Replacement pod grounds (5 per package)
E4	5090-4356		Grabber kit assembly (20 grabbers per package)
F1	2110-0055		1 Fuse (4 A, 250V)
H1	1400-0611	1	Clamp-cable
H2	01660-09101	1	Ground spring
H3	01650-46101	2	Locking pin PCB
H4	01660-67601	2	BNC connector assembly
H5	0515-1363	10	MS 3.0 5 TH T10 (disk drive, handle plate)
H6	0515-0680	2	MS 3.0 6 PH T10 (rear panel to HIL connector)
H7	0380-1858	2	Jackscrew with lock (printer port to rear panel)
H8	0515-0430	11	MS M3.0X0.5X6MM PH T10 (main circuit assembly, rear panel to chassis , RS-232C/GPIB cover plate)
H9	0515-2349	5	MS M3.0X0.50X14MM LG (trim strip cover to cabinet)
H10	0515-1035	2	MSFH M3 8 T10 (line filter)
H11	0515-1103	2	MSFH M3 10 T10 (trim strip cover to cabinet)
H12	0515-0664	4	MSPH M3 12 SMS10 (rear feet to cabinet)
H13	2950-0072	1	NUTH 1/4-32 .062 (intensity adjustment)
H14	2950-0001	2	NUTH 3/8-32 .093 (BNC trigger ports)
H15	0535-0056	3	NUT-HEX (monitor assembly)
H16	0515-0382	3	SM ASSY M4X0.7 12MM LG (monitor assembly, handle)
H17	0515-1349	4	SM M3X0.5 30MM LG (front panel assembly)
H18	3050-0010	4	WFL.147 .312 .03 (rear feet)
H19	2190-0027	1	WIL.256 .478 .02 (intensity adjustment)
H20	2190-0016	2	WIL.377 .507 .02 (BNC trigger ports)
H21	0515-1031	4	MSFH M3 6 T10 (accessory pouch)
H22	0515-2306	2	Screw Sems M3 X0.5X10mm (Cable Retaining Screw)
H23	2510-0332	4	SCR-MACH 8-32 (Fan)
H24	1252-2218	2	Cable Retaining Clip-20-pin connector (Monitor sweep cable)

Replaceable Parts  
**Replaceable Parts List**

---

**1664A Replaceable Parts**

---

<b>Ref. Des.</b>	<b>Agilent Part Number</b>	<b>Qty</b>	<b>Description</b>
H25	1252-2220	1	Cable Retaining Clip-34-pin connector (Disk drive cable)
MP1	01660-61606	1	Intensity adjustment assembly
MP2	01660-01203	1	Bracket-disk drive
MP3	3160-0092	1	Fan guard
MP4	01664-00201	1	Rear panel
MP5	54501-62702	1	Line filter/cable assembly
MP6	01660-01202	1	Handle plate
MP7	01650-01202	1	Ground bracket
MP8	01660-60001	1	Cabinet assembly
MP9	01660-04102	1	Cover assembly
MP10	54542-44901	1	Handle vinyl grip
MP11	35672-21703	2	Strap retainer
MP12	35672-45004	2	Handle end cap
MP13	5041-8801	2	Foot
MP14	1460-1345	2	Tilt Stand
MP15	01660-40501	4	Rear foot
MP16	5041-8822	2	Non-skid foot
MP17	01660-45401	1	Circuit board insulator
MP18	01660-01201	1	Circuit board mounting plate
MP19	01660-84501	1	Accessory pouch
MP20	01660-40502	1	Trim strip
MP21	01664-94301	1	ID label (1664A)
MP22	01660-94302	1	Line switch label
MP23	01660-41901	1	Elastomeric keypad
MP24	01660-47401	1	RPG knob
MP25	01660-60002	1	Assembled keyboard panel and label
	01660-45201	0	Keyboard panel-replacement
	01660-94303	0	Keyboard label-replacement
MP26	01660-44703	1	Keyboard spacer
MP27	01660-44702	1	Front panel spacer
MP28	01660-94306		Keyboard template, enter (accessory)
MP29	01660-94305		Keyboard template, F1-F8 (accessory)
MP30	01664-04101	1	Rear panel cover plate (RS-232, GPIB)
MP31	16555-60001	1	Ferrite Core Assembly
MP32	01664-44701	1	Rubber Spacer (Ferrite)
MP33	01660-94304	1	Label-Pods and Cable
W1	01650-61616	1	Fan cable
W2	01660-61603	1	Disk drive cable
W3	01660-61607	1	Jumper cable assembly-orange
W4	01660-61608	1	Jumper cable assembly-white
W5	54503-61606	1	Power supply cable
W6	01664-61601	1	Front Panel Cable Extender

---

**1664A Replaceable Parts**

---

<b>Ref. Des.</b>	<b>Agilent Part Number</b>	<b>Qty</b>	<b>Description</b>
W7	01650-61601	1	Monitor sweep cable
<b>Option #020</b>			
E5	01650-63202	1	RS-232 loopback connector
H26	0380-1482	2	Hex standoff (GPIB Cable)
H27	2190-0009	2	WIL.168 .340 .02 (GPIB Cable)
H28	0380-1858	2	Jackscrew with lock (RS-232 Cable)
MP34	1258-0141	1	Removable jumper
W8	01650-61613	1	GPIB Cable
W9	01660-61601	1	RS-232C Cable
<b>Power Cords</b>			
W10	8120-1521	1	Power Cord: United Kingdow (#900)
	8120-0696	1	Power Cord: Australia (#901)
	8120-1692	1	Power Cord: Europe (#902)
	8120-2296	1	Power Cord: Switzerland (#906)
	8120-2957	1	Power Cord: Denmark (#912)
	8120-4600	1	Power Cord: Africa (#917)
	8120-4754	1	Power Cord: Japan (#918)

## Power Cables and Plug Configurations

This instrument is equipped with a three-wire power cable. The type of power cable plug shipped with the instrument depends on the country of destination. The W10 reference designators (table, previous page) show option numbers of available power cables and plug configurations.

Block-Level Theory 8-3  
The 1660 Series Logic Analyzer 8-3  
    The Logic Acquisition Circuitry 8-6  
Self-Tests Description 8-9  
    Power-up Self-Tests 8-9  
    System Tests (System PV) 8-10  
    Analyzer Tests (Analy PV) 8-13  
GPIB 8-15  
RS-232C 8-16  
Centronix 8-17

---

## Theory of Operation

---

# Theory of Operation

This chapter tells the theory of operation for the logic analyzer and describes the self-tests. The information in this chapter is to help you understand how the logic analyzer operates and what the self-tests are testing. This information is not intended for component-level repair.



# Block-Level Theory

The block-level theory is divided into two parts: theory for the logic analyzer and theory for the main circuit board. A block diagram is shown with each theory.

## The 1664A Logic Analyzer

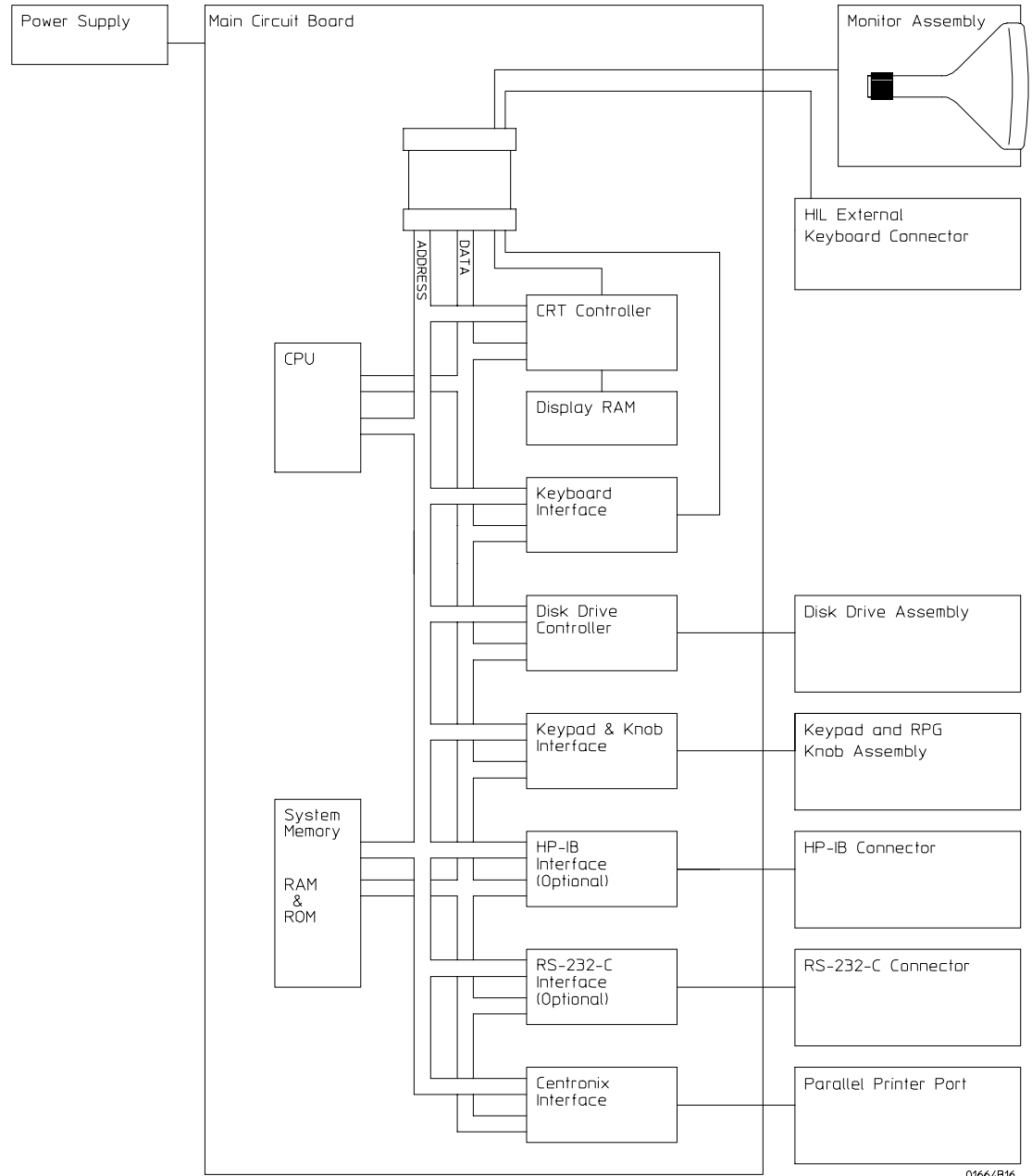

The 1664A logic analyzer

## **1664A Theory**

### **CPU**

Located on the main circuit board, the microprocessor is a Motorola 68EC020 running at 25 MHz. The microprocessor controls all of the functions of the logic analyzer including processing and storing data, displaying data, and configuring the acquisition ICs to obtain and store data.

### **System Memory**

The system memory is made up of both read-only memory (ROM) and random access memory (RAM). A single 128Kx8 EPROM is used as a boot ROM (boot-up requires operating system on disk loaded in the disk drive). Four 1Mx4 DRAMS are configured to provide a 1Mx16 DRAM space.

On power-up, instructions in the boot ROM command the instrument to execute its boot routine, which loads the operating system from disk. The boot routine (on disk) includes power-up operation verification of the instrument subsystems and entering the operating system. The CPU searches for the operating system on disk.

The DRAM stores the instrument configuration, acquired data to be processed, and any inverse assembler loaded in the instrument by the user.

### **CRT Controller and Display RAM**

A Brooktree BT476KPJ66 RAMDAC color palette and a National Semiconductor LM1882CM video frame generator control the CRT. One of the RGB outputs of the color palette provides the eight-shade grey scale display. The video frame generator provides the horizontal and vertical synchronization timing signals.

The display RAM is made up of two 256Kx4 DRAMS configured as 256Kx8 and stores all of the pixel information used by the color palette. A serial address counter and an address multiplexer control the DRAM addressing. At the conclusion of each video frame the vertical sync signal from the video generator resets the serial address counter and a new frame is generated.

### **Disk Drive Controller**

The disk drive controller consists of a single floppy drive controller IC. The floppy drive controller provides all signals to the disk drive including read and write data, read and write signals, write gate, and step signal. The floppy drive controller also reads status signals from the disk drive, including a track 00 signal, disk ready, and disk change signal.

### **Keypad and Knob Interface**

The front panel keypad is scanned directly from the microprocessor address bus during the video blanking cycle of the CRT. When a front panel key is pressed the associated address bits are fed to the data bus through the pressed key and read by the microprocessor.

The rotary pulse generator (RPG) knob is part of the HIL circuitry. Pulses and direction of rotation information are directed to an RPG interface IC and then to the HIL loop. The microprocessor then reads and interprets the RPG signals and performs the desired tasks.

### **External Keyboard Interface**

Agilent proprietary ICs make up the external keyboard interface. The ICs establish a link with the controller IC on the external keyboard. The keyboard signals are routed through the acquisition circuit board to the CPU board. The microprocessor then reads and interprets the external keyboard and mouse information and performs the desired tasks.

### **Centronix Interface**

The instrument parallel printer interface is compatible with industry standard Centronix protocol. The interface consists of a controller, and drivers/receivers. The controller conditions parallel data from the microprocessor for transmission. At the same time the controller also receives status information for the microprocessor. Data flow, status, and handshaking control are also provided by the controller.

### **Optional GPIB Interface**

The instrument interfaces to GPIB as defined by IEEE Standard 488.2. The interface consists of an GPIB controller and two octal drivers/receivers. The microprocessor routes GPIB data to the controller. The controller then buffers the 8-bit GPIB data bits and generates the bus handshaking signals. The data and handshaking signals are then routed to the GPIB bus through the octal line drivers/receivers. The drivers/receivers provide data and control signal transfer between the bus and controller.

### **Optional RS-232C Interface**

The instrument RS-232C interface is compatible with standard RS-232C protocol. The interface consists of a controller, and drivers/receivers. The controller serializes parallel data from the microprocessor for transmission. At the same time the controller also receives serial data and converts the data to parallel data characters for the microprocessor.

The controller contains a baud rate generator that can be programmed from the logic analyzer front panel for one of eight baud rates. Other RS-232C communications parameters can also be programmed from the logic analyzer front panel.

The drivers/receivers interface the instrument with data communications equipment. Slew rate control is provided on the ICs eliminating the need for external capacitors.

### **CRT Monitor Assembly**

The CRT Monitor Assembly consists of a monochrome CRT and a monitor driver board. The monitor driver board provides the biasing and control signals for the CRT. Pixel information is stored in the display RAM on the CPU board and is routed to the monitor driver board through the acquisition board and the sweep cable.

### **Disk Drive**

The disk drive assembly is a high density disk drive that formats double-sided, double-density or high density disks in LIF or DOS format. A disk drive controller on the CPU board controls the disk drive. Signals are routed directly to the disk drive through the disk drive cable.

### **Power Supply**

A low voltage power supply provides all DC voltages needed to operate the logic analyzer. The power supply also provides the +5 Vdc voltage to the probe cables to power logic analyzer accessories and preprocessors.

Unfiltered voltages of +12 V, -12 V, +5 V, -5.2 V, and +3.5 V are supplied to the acquisition board where they are filtered and distributed to the CPU board, CRT Monitor Assembly, and probe cables.

## The Logic Acquisition Circuitry

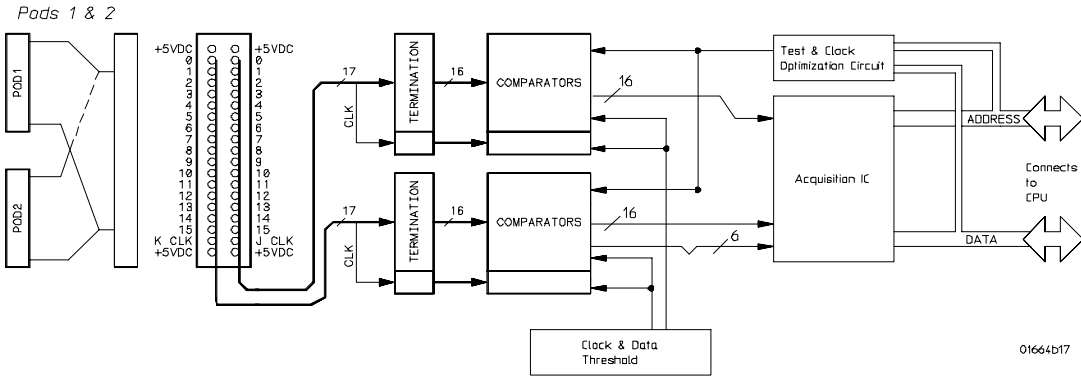

01664b17

## The Main Circuit Board Logic Acquisition Circuitry

## Main Circuit Board Logic Acquisition Theory

### Probing

The probing circuit includes the probe cable and terminations. The probe cable consists of two 17-channel pods which are connected to the circuit board using a high-density connector. Sixteen single-ended data channels and one single-ended clock/data channel are passed to the circuit board per pod.

If the clock/data channel is not used as a state clock in state acquisition mode, it is available as a data channel. The clock/data channel is also available as a data channel in timing acquisition mode. Two clock/data channels are available as data channels, and all clock data channels available can be assigned as clock channels.

The cables use nichrome wire woven in polyaramid yarn for reliability and durability. The pods also include one ground path per channel in addition to a pod ground. The channel grounds are configured such that their electrical distance is the same as the electrical distance of the channel.

The probe tip assemblies and termination modules connected at the end of the probe cables have a divide-by-10 RC network that reduces the amplitude of the data signals as seen by the circuit board. This adds flexibility to the types of signals the circuit board can read in addition to improving signal integrity.

The terminations on the circuit board are resistive terminations that reduce transmission line effects on the cable. The terminations also improve signal integrity to the comparators by matching the impedance of the probe cable channels with the impedance of the signal paths of the circuit board. All 17 channels of each pod are terminated in the same way. The signals are still reduced by a factor of 10.

### Comparators

Two proprietary 9-channel comparators per pod interpret the incoming data and clock signals as either high or low depending on where the user-programmable threshold is set. The threshold voltage of each pod is individually programmed, and the voltage selected applies to the clock channel as well as the data channels of each pod.

Each of the comparator ICs has a serial test input port used for testing purposes. A test bit pattern is sent from the Test and Clock Synchronization Circuit to the comparator. The comparators then propagate the test signal on each of the nine channels of the comparator. Consequently, all data and clock channel pipelines on the circuit board can be tested by the operating system software from the comparator.

### Acquisition

The acquisition circuit is made up of a single Agilent Technologies proprietary ASIC. Each ASIC is a 34-channel state/timing analyzer, and one such ASIC is included for every two logic analyzer pods. All of the sequencing, pattern/range recognition, and event counting functions are performed on board the IC.

In addition to the storage qualification and counting functions, the acquisition ASICs also perform master clocking functions. All six state acquisition clocks are fed to each IC, and the ICs generate their own sample clocks. Every time you select RUN, the ICs individually perform a clock optimization before data is stored.

Clock optimization involves using programmable delays on board the IC to position the master clock transition where valid data is captured. This procedure greatly reduces the effects of channel-to-channel skew and other propagation delays.

In the timing acquisition mode, an oscillator-driven clock circuit provides a four-phase, 100-MHz clock signal to each of the acquisition ICs. For high speed timing acquisition (100 MHz and faster), the sample period is determined by the four-phase, 100-MHz clock signal.

For slower sample rates, one of the acquisition ICs divides the 100-MHz clock signal to the appropriate sample rate. The sample clock is then fed to all acquisition ICs.

### **Threshold**

A precision octal DAC and precision op amp drivers make up the threshold circuit. Each of the eight channels of the DAC is individually programmable which allows you to set the thresholds of the individual pods. The 16 data channels and the clock channel of each pod are all set to the same threshold voltage.

### **Test and Clock Synchronization Circuit**

ECLinPS (TM) ICs are used in the Test and Clock Synchronization Circuit for reliability and low channel-to-channel skew. Test patterns are generated and sent to the comparators during software operation verification. The test patterns are propagated across all data and clock channels and read by the acquisition ASIC to ensure both the data and clock pipelines are operating correctly.

The Test and Clock Synchronization Circuit also generates a four-phase, 100-MHz sample/synchronization signal for the acquisition ICs operating in the timing acquisition mode. The synchronizing signal keeps the internal clocking of the individual acquisition ASICs locked in step with the other ASICs at fast sample rates. At slower sample rates, one of the acquisition ICs divides the 100-MHz clock signal to the appropriate sample rate. The slow speed sample clock is then used by all acquisition ICs.

---

## Self-Tests Description

The self-tests identify the correct operation of major functional areas in the logic analyzer. The self-tests are not intended for component-level diagnostics.

Three types of tests are performed on the 1664A logic analyzer: the power-up self-tests, the functional performance verification self-tests, and the parametric performance verification tests.

The power-up self-tests are performed when power is applied to the instrument.

The functional performance verification self-tests are run using a separate operating system, the performance verification (PV) operating system. The PV operating system resides on a separate disk that must be inserted in the disk drive when running the functional performance verification self-tests. The system and analyzer tests are functional performance verification tests.

Parametric performance verification requires the use of external test equipment that generates and monitors test data for the logic analyzer to read. The performance verification procedures in chapter 3 of this service guide make up the parametric performance verification for the logic analyzer. Refer to chapter 3, "Testing Performance," for further information about parametric performance verification.

---

### Power-up Self-Tests

The power-up self-tests are divided into two parts. The first part is the system memory tests and the second part is the microprocessor interrupt test. The system memory tests are performed before the logic analyzer actually displays the power-up self-test screen. Both the system ROM and RAM are tested during power-up. The interrupt test is performed after the power-up self-test screen is displayed.

The following describes the power-up self-tests:

#### **ROM Test**

The ROM test performs several checksum tests on various read only memory elements, including the system ROM as well as the various software modules present in flash ROM.

Passing the ROM test implies that the microprocessor can access each ROM memory address and that each ROM segment provides checksums that match previously calculated values.

### **RAM Test**

The RAM test checks the video RAM (VRAM), system dynamic RAM (DRAM), and static RAM memory within the real time clock IC. The microprocessor first performs a write/read in each memory location of the VRAM. At each VRAM memory location a test pattern is written, read, and compared. An inverse test pattern is then written, read, and compared. After verifying correct operation of the VRAM, the System RAM and real time clock RAM are tested in a similar fashion.

Passing the RAM test implies that the microprocessor can access each VRAM memory location and that each VRAM memory location can store a logical "1" or a logical "0." If the VRAM is functioning properly, the logic analyzer can construct a correct, undistorted display. Passing the RAM test also implies that the memory locations of system RAM can be accessed by the microprocessor and the data in RAM is intact, and that the memory locations inside the real time clock IC can store a logical "1" or a logical "0."

### **Interrupt Test**

The Interrupt Test checks the microprocessor interrupt circuitry. With all interrupts disabled from their source, the microprocessor waits for a short period of time to see if any of the interrupt lines are asserted. An asserted interrupt line during the wait period signifies incorrect functioning of the device generating the interrupt or the interrupt circuitry itself. Those interrupts that can be asserted under software control are exercised to verify functionality.

Passing the Interrupt Test implies that the interrupt circuitry is functioning properly. Passing the Interrupt Test also implies that the interrupt generating devices are also functioning properly and not generating false interrupts. This means that the microprocessor can execute the operating system code and properly service interrupts generated by pressing a front panel key or receiving an GPIB or RS-232C command.

---

## **System Tests (System PV)**

The system tests are functional performance verification tests. The following describes the system tests:

### **ROM Test**

The ROM test performs several checksum tests on various read only memory elements, including the system ROM.

Passing the ROM test implies that the microprocessor can access each ROM memory address and that each ROM segment provides checksums that match previously calculated values.

### **RAM Test**

The RAM test performs a write/read operation in each memory location in system dynamic RAM (DRAM). The video RAM in the display subsystem and the acquisition RAM in the data acquisition subsystem are not tested as part of the RAM test and are tested elsewhere. At each DRAM memory location, the code that resides at that location is stored in a microprocessor register. A test pattern is then stored at the memory location, read, and compared. An inverse test pattern is then stored, read, and compared. The original code is then restored to the memory location. This continues until all DRAM memory locations have been tested. The static RAM in the real time clock chip is also tested in a similar fashion.

Passing the RAM test implies that all RAM memory locations can be accessed by the microprocessor and that each memory location can store a logical "1" or a logical "0."



### **GPIB Test**

The GPIB test performs a write/read operation to each of the registers of the GPIB IC. A test pattern is written to each register in the GPIB IC. The pattern is then read and compared with a known value. The GPIB test will return a valid "Pass" or "Fail" status even if option 020 is not installed.

Passing the GPIB test implies that the read/write registers in the GPIB IC can store a logical "1" or a logical "0," and that the GPIB IC is functioning properly. Incoming and outgoing GPIB information will not be corrupted by the GPIB IC.

### **RS-232C Test**

This test checks the basic interface functions of the RS-232C port. Both internal and external portions of the port circuitry are tested. In order for the RS-232C test to pass, option 020 must be installed and the RS-232C loopback connector must be installed on the RS-232C connector.

### **HIL Test**

The HIL test exercises both the HIL circuitry internal to the logic analyzer and the HIL interface between the logic analyzer and external keyboard, if an external keyboard is connected. First, a read/write operation is performed to each of the registers of the HIL IC. A test pattern is written to each memory location, read, and compared with a known value. Second, if an external keyboard is connected to the HIL port, the keyboard controller that resides in the keyboard is polled by the microprocessor. A test pattern is sent to the keyboard controller and returned to the microprocessor by the keyboard controller. The test pattern is then compared with a known value.

Passing the HIL test implies that the read/write registers in the HIL IC can store a logical "1" or a logical "0," and that the HIL IC is functioning properly. Also, passing the HIL test implies that the HIL pathway to the external keyboard is functioning and that the keyboard controller can communicate with the microprocessor in the logic analyzer. Incoming HIL information from the external keyboard will not be corrupted by the pathway between the keyboard controller and microprocessor.

### **Disk Test**

The disk test exercises the disk controller circuitry by performing a read/write on a disk. Either an LIF formatted disk with 20 sectors available space or a DOS formatted disk with 5K available space is required and should be inserted in the disk drive. When the disk test is executed, the disk is checked sector by sector to find any bad sectors. If no bad sectors are found, a test file is created on the disk and test data is written to the file. Then, the file is read and the test data is compared with known values. At the conclusion of the test, the test file is erased.

Passing the disk test implies that the disk controller circuitry in the logic analyzer and the disk read/write circuitry in the disk drive are functioning properly. The disk drive can read and write to a LIF or DOS formatted disk, and the data will not be corrupted by the disk drive circuitry.

### **Perform Test All**

Selecting Perform Test All will initiate all of the previous functional verification tests in the order they are listed. The failure of any or all of the tests will be reported in the test menu field of each of the tests. The Perform All Test will not initiate the Front Panel Test or the Display Test.

### **Front Panel Test**

A mock-up of the logic analyzer front panel is displayed on the CRT when the Front Panel Test is initiated. The operator then pushes each front panel button and turns the RPG (rotary pulse generator) knob to toggle the corresponding fields from light to dark on the front panel mock-up. Successively pushing any front panel key will cause the corresponding field to toggle back and forth between light and dark. An exception is the Done key. Pressing the Done key a second time will cause an exit of this test.

The Front Panel Test passes when all of the key fields in the front panel mock-up on the CRT can be toggled by pressing the corresponding front panel key, and the two RPG fields can be toggled by turning the knob. The Front Panel Test is not called when Perform Test All is selected.

### **Display Test**

When initiated, the display test will cause three test screens to be displayed sequentially. The first test screens is a test pattern used to align the CRT. The second two screens verify correct operation of the color palette by displaying first a full bright screen and then a half bright screen.

The pass or fail status of the display test is determined by the operator. The Display Test passes when all three test screens are displayed according to chapter 4, "Calibrating and Adjusting." The display test is not used when Perform Test All is selected.

---

## Analyzer Tests (Analy PV)

The analyzer tests are functional performance verification tests. There are three types of analyzer tests: the Board Test, the Chip Test, and the Data Input Inspection. The following describes the analyzer self-tests:

### Board Test

The Board Test functionally verifies the two oscillators and the 9-channel comparators on the circuit board. First, the oscillators are checked using the event counter on one of the acquisition ICs. The event counter will count the number of oscillator periods within a pre-determined time window. The count of oscillator periods is then compared with a known value.

The comparators are then checked by varying the threshold voltage and reading the state of the activity indicators. The outputs of the octal DAC are set to the upper voltage limit and the activity indicators for all of the pod channels are read to see if they are all in a low state.

The octal DAC outputs are then set to the lower voltage limit, and the activity indicators are read to see if they are in a high state. The DAC outputs are then set to 0.0 V, allowing the comparators to recognize the test signal being routed to the test input pin of all of the comparators. Consequently, the activity indicators are read to see if they show activity on all channels of all of the pods.

### Chip Tests

During the Chip Tests, six tests are performed on the acquisition ICs. The tests are the Communications, Memory, Encoder, Resource, Sequencer, and Clock Generation Tests.

**Communications Test** The communications test verifies that communications pipeline between the various subsystems of the IC are operating. Checkerboard patterns of "1s" and "0s" are routed to the address and data buses and to the read/write registers of each chip. After verifying the communications pipelines, the acquisition clock synchronization signals that are routed from IC to IC are checked. Finally, the IC master clock optimization path is checked and verified.

Passing the communications test implies that the communications pipelines running from subsystem to subsystem on the acquisition IC are functioning and that the clock optimization circuit on the IC is functioning. Also, passing this test implies that the acquisition clock synchronization signals are functioning and appear at the synchronization signal output pins of the acquisition IC.

**Memory Test** Acquisition RAM is checked by filling the IC RAM with a checkerboard pattern of "1s" and "0s," then reading each memory location and comparing the test pattern with known values. Then, the IC RAM is filled with an inverse checkerboard pattern, read, and compared with known values.

Passing the memory test implies that the acquisition IC RAM is functioning and that each memory location bit can hold either a logical "1" or logical "0."

**Encoder Test** The encoder in the FISO front end is tested and verified using a walking "1" and walking "0" pattern. The walking "1" and "0" is used to stimulate all of the encoder output pins which connect directly to the FISO memory cells. Additionally, the post-store counter in each of the acquisition ICs is tested.

Passing the encoder test implies that the FISO encoder is functioning and can properly route the acquired data to the acquisition memory FISO RAM. Also, passing this test implies that the post-store counter on the acquisition ICs is functioning.

**Resource Test** The pattern, range, edge, and glitch recognizers are tested and verified. First, the test register is verified for correct operation. Next, the pattern comparators are tested to ensure that each bit in the recognizer memory location as well as the logic driver/receiver are operating. The edge and glitch pattern detectors are then verified in a similar manner. The range detectors are verified with their combinational logic to ensure that the in- and out-of-range conditions are recognized.

Passing the resource test implies that all of the pattern, range, edge, and glitch resources are operating and that an occurrence of the pattern, edge, or glitch of interest is recognized. Also, passing this test implies that the range recognizers will detect and report in- and out-of-range acquisition data to the sequencer or storage qualifier. The drivers and receivers at the recognizer input and output pins of the acquisition IC are also checked to be sure they are functioning.

**Sequencer Test** The sequencer, the state machine that controls acquisition storage, is tested by first verifying that all of the sequencer registers are operating. After the registers are checked, the combinational logic of the storage qualification is verified. Then, both the occurrence counter and the sequencer level counter are checked.

Passing the sequencer test implies that all 12 available sequence levels are functioning and that all possible sequence level jumps can occur. Also, passing this test implies that user-defined ANDing and ORing of storage qualified data patterns will occur, and that the occurrence counter that appears at each sequence level is functioning.

**Clock Generator Test** The master clock generator on the acquisition ICs is tested by first checking the operation of the clock optimization circuit. The state acquisition clock paths are then checked to ensure that each state clock and clock qualifier are operating by themselves and in all possible clock and qualifier combinations. The timing acquisition optimization circuit is then operationally verified. Finally, the timing acquisition frequency divider (for slower timing sample rates) is checked.

Passing the clock generator test implies that each acquisition IC can generate its own master clock whether the clock is generated using a combination of external clocking signals (state mode) or internal sample clock signals (timing mode).

### **Data Input Inspection**

The data input inspection allows a user to verify that all of the data and clock/data pipelines are operational. When the data input inspection test is selected, a test signal is fed to the test input pins of all 9-channel comparators. The test menu displays the activity indicators for all data and clock/data channels, which should show transitioning data signals on all channels.

The data input inspection is not an active part of the performance verification. However, the test is useful for identifying failed channels in order to temporarily work around the problem until the logic analyzer module can be sent to an Agilent Technologies service center for repair.

## GPIB (Optional)

The General Purpose Interface bus (GPIB) is Agilent Technologies' implementation of IEEE Standard 488-1978, "Standard Digital Interface for Programming Instrumentation." GPIB is a carefully defined interface that simplifies the integration of various instruments and computers into systems. The interface makes it possible to transfer messages between two or more GPIB compatible devices. GPIB is a parallel bus of 16 active signal lines divided into three functional groups according to function.

Eight signal lines, called data lines, are in the first functional group. The data lines are used to transmit data in coded messages. These messages are used to program the instrument function, transfer measurement data, and coordinate instrument operation. Input and output of all messages, in bit parallel-byte serial form, are also transferred on the data lines. A 7-bit ASCII code normally represents each piece of data.

Data is transferred by means of an interlocking "Handshake" technique which permits data transfer (asynchronously) at the rate of the slowest active device used in that transfer. The data byte control lines coordinate the handshaking and form the second functional group.

The remaining five general interface management lines (third functional group) are used to manage the devices connected to the GPIB. This includes activating all connected devices at once, clearing the interface, and other operations.

The following figure shows the connections to the GPIB connector located on the rear panel.

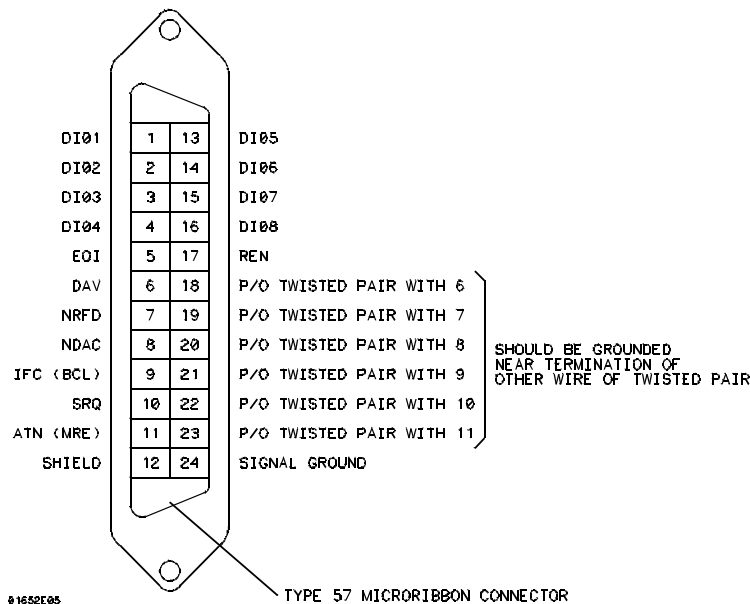

### GPIB Interface Connector

---

## RS-232C(Optional)

The logic analyzer interfaces with RS-232C communication lines through a standard 25 pin D connector. The logic analyzer is compatible with RS-232C protocol. When a hardwire handshake method is used, the Data Terminal Ready (DTR) line, pin 20 on the connector, is used to signal if space is available for more data in the logical I/O buffer. Pin outs of the RS-232C connectors are listed in the following table.

---

### RS-232C Signal Definitions

---

Pin Number	Function	RS-232C Standard	Signal Direction and Level
1	Protective Ground	AA	Not applicable
2	Transmitted Data (TD)	BA	Data from Mainframe High = Space = "0" = +12 V Low = Mark = "1" = -12 V
3	Received Data (RD)	BB	Data to Mainframe High = Space = "0" = +3 V to +25 V Low = Mark = "1" = -3 V to -25 V
4	Request to Send (RTS)	CA	Signal from Mainframe High = ON = +12 V Low = OFF = -12 V
5	Clear to Send (CTS)	CB	Signal to Mainframe High = ON = +3 V to +12 V Low = OFF = -3 V to -25 V
6	Data Set Ready (DSR)	CC	Signal to Mainframe High = ON = +3 V to +25 V Low = OFF = -3 V to -25 V
7	Signal Ground	AB	Not applicable
8	Data Carrier Detect (DCD)	CF	Signal to Mainframe High = ON = +3 V to +25 V Low = OFF = -3 V to -25 V
20	Data Terminal Ready (DTR)	CD	Signal from Mainframe High = ON = +12 V Low = OFF = -12 V
23	Data Signal Rate Selector	CH/CI	Signal from Mainframe Always High = ON = +12 V

The logic analyzer interfaces with Centronix (parallel printer) communication lines through a standard 25 pin D connector. The logic analyzer is compatible with Centronix protocol. BUSY is used to indicate when data can be transferred from the logic analyzer to the printer. DATASTROBE is used to synchronize data transmissions. Pin outs of the Centronix connector are listed in the following table.

---

## Centronix Signal Definitions

---

<b>Pin Number</b>	<b>Function</b>	<b>Centronix Standard</b>
1	Synchronous signal that is used for data transfer	STROBE
2	Logic analyzer data (LSB)	DATA0
3	Logic analyzer data	DATA1
4	Logic analyzer data	DATA2
5	Logic analyzer data	DATA3
6	Logic analyzer data	DATA4
7	Logic analyzer data	DATA5
8	Logic analyzer data	DATA6
9	Logic analyzer data (MSB)	DATA7
10	Signal used to indicate that data has been received	ACKNLG
11	Signal used to indicate that the printer is busy	BUSY
12	Signal used to indicate that the printer is out of paper	PERROR
13	Signal that indicates that the printer is on-line	SELECT
14	Signal used to select the autofeed function	AUTOFD
15	Signal that indicates command or data error	FAULT
16	Signal used to initialize the printer	INIT
17	Signal used to select the direction of the bi-directional bus	SELECTIN
18 - 25	Ground	GND





# DECLARATION OF CONFORMITY

according to ISO/IEC Guide 22 and EN 45014

**Manufacturer's Name:** Agilent Technologies  
**Manufacturer's Address:** 1900 Garden of the Gods Road  
Colorado Springs , CO 80901  
U.S.A.

## Declares, That the product

**Product Name:** Logic Analyzer  
**Model Number(s):** 1664A  
**Product Options:** All

## Conforms to the following Product Specifications:

**Safety:** IEC 348 / HD 401  
UL 1244  
CSA - C22.2 No. 231 Series M-89  
**EMC:** CISPR 11:1990 /EN 55011 (1991): Group 1 Class A  
IEC 801-2:1991 /EN 50082-1 (1992): 4 kV CD, 8 kV AD  
IEC 801-3:1984 /EN 50082-1 (1992): 3 V/m  
IEC 801-4:1988 /EN 50082-1 (1992): 1 kV

## Supplementary Information:

The product herewith complies with the requirements of the Low Voltage Directive 73/23/EEC and the EMC Directive 89/336/EEC.

Colorado Springs, Sept 16, 1994

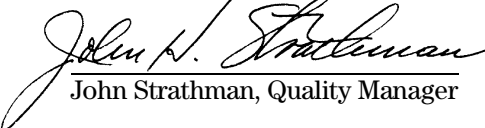
  
John Strathman, Quality Manager

European Contact: Your local Agilent Technologies Sales and Service Office or Agilent Technologies GmbH,  
Department ZQ / Standards Europe, Herrenberger Strasse 130, 71034 Böblingen Germany (FAX: +49-7031-143143)



© Copyright Agilent Technologies  
1987-2000  
All Rights Reserved.

Reproduction, adaptation, or translation without prior written permission is prohibited, except as allowed under the copyright laws.

#### Document Warranty

The information contained in this document is subject to change without notice.

**Agilent Technologies makes no warranty of any kind with regard to this material, including, but not limited to, the implied warranties or merchantability and fitness for a particular purpose.**

Agilent Technologies shall not be liable for errors contained herein or for incidental or consequential damages in connection with the furnishing, performance, or use of this material.

Complete product warranty information is given at the end of this manual.

#### Safety

This apparatus has been designed and tested in accordance with IEC Publication 348, Safety Requirements for Measuring Apparatus, and has been supplied in a safe condition. This is a Safety Class I instrument (provided with terminal for protective earthing). Before applying power, verify that the correct safety precautions are taken (see the following warnings). In addition, note the external markings on the instrument that are described under "Safety Symbols."

#### Warning

- Before turning on the instrument, you must connect the protective earth terminal of the instrument to the protective conductor of the (mains) power cord. The mains plug shall only be inserted in a socket outlet provided with a protective earth contact. You must not negate the protective action by using an extension cord (power cable) without a protective conductor (grounding). Grounding one conductor of a two-conductor outlet is not sufficient protection.
- Only fuses with the required rated current, voltage, and specified type (normal blow, time delay, etc.) should be used. Do not use repaired fuses or short-circuited fuseholders. To do so could cause a shock or fire hazard.

- Service instructions are for trained service personnel. To avoid dangerous electric shock, do not perform any service unless qualified to do so. Do not attempt internal service or adjustment unless another person, capable of rendering first aid and resuscitation, is present.
- If you energize this instrument by an auto transformer (for voltage reduction), make sure the common terminal is connected to the earth terminal of the power source.
- Whenever it is likely that the ground protection is impaired, you must make the instrument inoperative and secure it against any unintended operation.
- Do not operate the instrument in the presence of flammable gasses or fumes. Operation of any electrical instrument in such an environment constitutes a definite safety hazard.
- Do not install substitute parts or perform any unauthorized modification to the instrument.
- Capacitors inside the instrument may retain a charge even if the instrument is disconnected from its source of supply.
- Use caution when exposing or handling the CRT. Handling or replacing the CRT shall be done only by qualified maintenance personnel.

#### Safety Symbols



Instruction manual symbol: the product is marked with this symbol when it is necessary for you to refer to the instruction manual in order to protect against damage to the product.



Hazardous voltage symbol.



Earth terminal symbol: Used to indicate a circuit common connected to grounded chassis.

#### WARNING

The Warning sign denotes a hazard. It calls attention to a procedure, practice, or the like, which, if not correctly performed or adhered to, could result in personal injury. Do not proceed beyond a Warning sign until the indicated conditions are fully understood and met.

#### CAUTION

The Caution sign denotes a hazard. It calls attention to an operating procedure, practice, or the like, which, if not correctly performed or adhered to, could result in damage to or destruction of part or all of the product. Do not proceed beyond a Caution symbol until the indicated conditions are fully understood or met.

---

**Product Warranty**

This Agilent Technologies product has a warranty against defects in material and workmanship for a period of one year from date of shipment. During the warranty period, Agilent Technologies will, at its option, either repair or replace products that prove to be defective.

For warranty service or repair, this product must be returned to a service facility designated by Agilent Technologies.

For products returned to Agilent Technologies for warranty service, the Buyer shall prepay shipping charges to Agilent Technologies and Agilent Technologies shall pay shipping charges to return the product to the Buyer. However, the Buyer shall pay all shipping charges, duties, and taxes for products returned to Agilent Technologies from another country. Agilent Technologies warrants that its software and firmware designated by Agilent Technologies for use with an instrument will execute its programming instructions when properly installed on that instrument. Agilent Technologies does not warrant that the operation of the instrument software, or firmware will be uninterrupted or error free.

**Limitation of Warranty**

The foregoing warranty shall not apply to defects resulting from improper or inadequate maintenance by the Buyer, Buyer-supplied software or interfacing, unauthorized modification or misuse, operation outside of the environmental specifications for the product, or improper site preparation or maintenance.

No other warranty is expressed or implied. Agilent Technologies specifically disclaims the implied warranties or merchantability and fitness for a particular purpose.

**Exclusive Remedies**

The remedies provided herein are the buyer's sole and exclusive remedies. Agilent Technologies shall not be liable for any direct, indirect, special, incidental, or consequential damages, whether based on contract, tort, or any other legal theory.

**Assistance**

Product maintenance agreements and other customer assistance agreements are available for Agilent Technologies products.

For any assistance, contact your nearest Agilent Technologies Sales Office.

**Certification**

Agilent Technologies certifies that this product met its published specifications at the time of shipment from the factory. Agilent Technologies further certifies that its calibration measurements are traceable to the United States National Institute of Standards and Technology, to the extent allowed by the Institute's calibration facility, and to the calibration facilities of other International Standards Organization members.

**About this edition**

This is the first edition of the *Agilent Technologies 1664A Logic Analyzer Service Guide*.

Publication number 01664-97005

Printed in USA.

Edition dates are as follows:

Second edition, January 2000

First edition, August 1994

New editions are complete revisions of the manual. Update packages, which are issued between editions, contain additional and replacement pages to be merged into the manual by you. The dates on the title page change only when a new edition is published.

A software or firmware code may be printed before the date. This code indicates the version level of the software or firmware of this product at the time the manual or update was issued. Many product updates do not require manual changes; and, conversely, manual corrections may be done without accompanying product changes. Therefore, do not expect a one-to-one correspondence between product updates and manual updates.

The following list of pages gives the date of the current edition and of any changed pages to that edition.

All pages original edition.

## Free Manuals Download Website

<http://myh66.com>

<http://usermanuals.us>

<http://www.somanuals.com>

<http://www.4manuals.cc>

<http://www.manual-lib.com>

<http://www.404manual.com>

<http://www.luxmanual.com>

<http://aubethermostatmanual.com>

Golf course search by state

<http://golfingnear.com>

Email search by domain

<http://emailbydomain.com>

Auto manuals search

<http://auto.somanuals.com>

TV manuals search

<http://tv.somanuals.com>