

Errata

Title & Document Type: 1650A/1651A Logic Analyzers Getting Started Guide

Manual Part Number: 5954-2664

Revision Date: June 1987

HP References in this Manual

This manual may contain references to HP or Hewlett-Packard. Please note that Hewlett-Packard's former test and measurement, semiconductor products and chemical analysis businesses are now part of Agilent Technologies. We have made no changes to this manual copy. The HP XXXX referred to in this document is now the Agilent XXXX. For example, model number HP8648A is now model number Agilent 8648A.

About this Manual

We've added this manual to the Agilent website in an effort to help you support your product. This manual provides the best information we could find. It may be incomplete or contain dated information, and the scan quality may not be ideal. If we find a better copy in the future, we will add it to the Agilent website.

Support for Your Product

Agilent no longer sells or supports this product. You will find any other available product information on the Agilent Test & Measurement website:

www.tm.agilent.com

Search for the model number of this product, and the resulting product page will guide you to any available information. Our service centers may be able to perform calibration if no repair parts are needed, but no other support from Agilent is available.





Getting Started Guide

HP 1650A/51A Logic Analyzers



© Copyright Hewlett-Packard Company 1987

Manual Part Number 5954-2664

Printed in U.S.A. June 1987

Introduction

About this book...

Welcome to the new generation of HP logic analyzers. The HP 1650A/51A logic analyzers have been designed to be the easiest to use logic analyzers ever. In addition to being easy to use, these logic analyzers make a significant contribution to digital measurement technology.

That's why we'd like you to invest your time going through this *Getting Started* manual. Whether you're a novice logic analyzer user or just new to these particular models, this book will give you a working knowledge of the HP 1650A/51A so that you can start using it to solve your measurement problems. It covers:

- front panel organization;
- how to operate the front panel;
- learning the basic menus;
- how to set up the analyzer
- how to make basic measurements.

To make the book easier to use, we have put the names of keys (**FORMAT**, **SELECT** etc.) in bold type. And we have highlighted actions (rotate the knob, press the **DISPLAY**) in color.

If you are an experienced HP logic analyzer user but new to this family of logic analyzers, you may feel like going directly to the reference manual. We'd like you to reconsider and read chapters 1 through 4 first. These chapters will only take a few minutes and you will find the user interface of the HP 1650A/51A very friendly and easy to learn.

Don't worry...we didn't try to cover every feature and function of the HP 1650A/51A logic analyzers in this manual. That's the job of your *HP 1650/51A Reference Manual*. Also, if you have not read the *Setting Up the Logic Analyzer booklet*, please do so now.

If you're new to logic analysis...or just need a refresher, we think you'll find *Feeling Comfortable With Logic Analyzers* valuable reading. It will help you sort out any confusion you may have about their application and show you how to get the most out of your new logic analyzer.

Table of Contents

Introduction

Chapter 1: What Is the HP 1650A/51A?

Chapter 2: Getting to Know the Front Panel

- 2-1 Introduction
 - 2-1 Front Panel Organization
 - 2-2 Cursor
 - 2-3 Keypad
 - 2-4 Roll
 - 2-5 Menu
 - 2-6 Display
 - 2-7 Disc Drive
 - 2-7 Summary
-

Chapter 3: How Do I Use the Front Panel?

- 3-1 Introduction
- 3-2 Menu Field Conventions
- 3-3 Your First Step
- 3-4 Returning to the System Configuration Menu
- 3-5 Exploring the System Configuration Menu
- 3-6 Closing Pop-up Menus
- 3-7 Summary

Table of Contents (Continued)

| | |
|-------------------|---------------------------------|
| Chapter 4: | Learning the Basic Menus |
| 4-1 | Introduction |
| 4-1 | Selector Pop-up Menu |
| 4-1 | Switching Between Analyzers |
| 4-3 | Assigning Pods |
| 4-4 | Alpha Entry Pop-up Menu |
| 4-7 | Changing Alpha Entries |
| 4-9 | Numeric Entry Menus |
| 4-13 | Assignment/Specification Menus |
| 4-13 | Assigning Bits to Pods |
| 4-15 | Specifying Patterns |
| 4-16 | Specifying Edges |
| 4-18 | Summary |

| | |
|-------------------|--|
| Chapter 5: | Using the Timing Analyzer |
| 5-1 | Introduction |
| 5-2 | Problem Solving with the Timing Analyzer |
| 5-2 | What Am I Going to Measure? |
| 5-3 | How Do I Configure the Logic Analyzer? |
| 5-5 | Connecting the Probes |
| 5-5 | Activity Indicators |
| 5-6 | Configuring the Timing Analyzer |
| 5-8 | Specifying a Trigger Condition |
| 5-9 | Acquiring the Data |
| 5-11 | The Timing Waveforms Menu |
| 5-11 | The X and O |
| 5-12 | The ▼ |
| 5-12 | The Vertical Dotted line |
| 5-13 | Configuring the Display |
| 5-13 | Display Resolution |
| 5-14 | Making the Measurement |
| 5-15 | Finding the Answer |
| 5-16 | Summary |

Table of Contents (Continued)

Chapter 6:

Using the State Analyzer

- 6-1 Introduction
 - 6-2 Problem Solving with the State Analyzer
 - 6-2 What Am I Going to Measure?
 - 6-4 How Do I Configure the Logic Analyzer?
 - 6-6 Connecting the Probes
 - 6-6 Activity Indicators
 - 6-7 Configuring the State Analyzer
 - 6-9 Specifying the J Clock
 - 6-10 Specifying a Trigger Condition
 - 6-12 Acquiring the Data
 - 6-13 The State Listing
 - 6-14 Finding the Answer
 - 6-16 Summary
-

Chapter 7:

Using the Timing/State Analyzer

- 7-1 Introduction
- 7-2 Problem Solving with the Timing/State Analyzer
- 7-2 What Am I Going to Measure?
- 7-3 How Do I Configure the Logic Analyzer?
- 7-4 Configuring the State Analyzer
- 7-5 Connecting the Probes
- 7-5 Acquiring the Data
- 7-6 Finding the Problem
- 7-7 What Additional Measurements Must I Make?
- 7-8 How Do I Re-configure the Logic Analyzer?
- 7-8 Connecting the Timing Analyzer Probes
- 7-9 Configuring the Timing Analyzer
- 7-10 Setting the Timing Analyzer Trigger
- 7-11 Time Correlating the Data
- 7-12 Re-acquiring the Data
- 7-12 Mixed Mode Display
- 7-13 Interpreting the Display
- 7-14 Overlapping Timing Waveforms
- 7-15 Finding the Answer
- 7-16 Summary

Table of Contents (Continued)

| | |
|-------------------|---|
| Chapter 8: | Making Hardcopy Prints |
| 8-1 | Introduction |
| 8-1 | Hooking Up Your Printer |
| 8-2 | Setting RS-232C for HP Printers |
| 8-3 | Setting RS-232C for Your Non-HP Printer |
| 8-4 | Starting the Printout |
| 8-4 | Print Screen |
| 8-5 | Print All |
| 8-5 | What Happens during a Printout? |
| 8-6 | Summary |

| | |
|-------------------|---------------------|
| Chapter 9: | What's Next? |
|-------------------|---------------------|

| | |
|--------------------|--|
| Appendix A: | Logic Analyzer Turn-on Check List |
|--------------------|--|

| | |
|--------------------|---|
| Appendix B: | Loading Demo Files from the Disc |
|--------------------|---|

What Is the HP 1650A/51A?

The HP 1650A/51A logic analyzers are a new generation of general purpose logic analyzers. The HP 1650A is an 80-channel logic analyzer while the HP 1651A is a 32-channel version of the HP 1650A. Both analyzer models are capable of 100 MHz timing and 25 MHz state analysis on all channels. The HP 1651A, while only having 32 channels, is packed with the same feature set as its big brother, the HP 1650A. That's why you have the same manual set regardless of whether you have an HP 1650A or HP 1651A.

The key features of the HP 1650A and HP 1651A are:

- Transitional or glitch timing modes
- Simultaneous state/state or state/timing modes
- 1k-deep memory on all channels
- Glitch detection on all channels
- Marker measurements
- Pattern, edge, and glitch triggering
- Overlapping of timing waveforms
- Eight sequence levels
- Eight pattern recognizers
- One range recognizer
- Small lightweight probing
- Time and number of states tagging
- Pre-store

Not all of these features will be covered in this Getting Started manual. However, you can find the details of these and all the features of the HP 1650A/51A in the *HP 1650A/51A Reference Manual*.

2

Getting to Know the Front Panel

Introduction

The HP 1650A/51A logic analyzers have been designed to be very easy to use. The controls are located logically by function so you can learn how to use them quickly and easily.

This chapter breaks down the front panel into these functional areas and gives you an overview of each area.

Front Panel Organization

The functional areas of the front panel are: display, MENU, keypad, CURSOR, ROLL and disc drive.

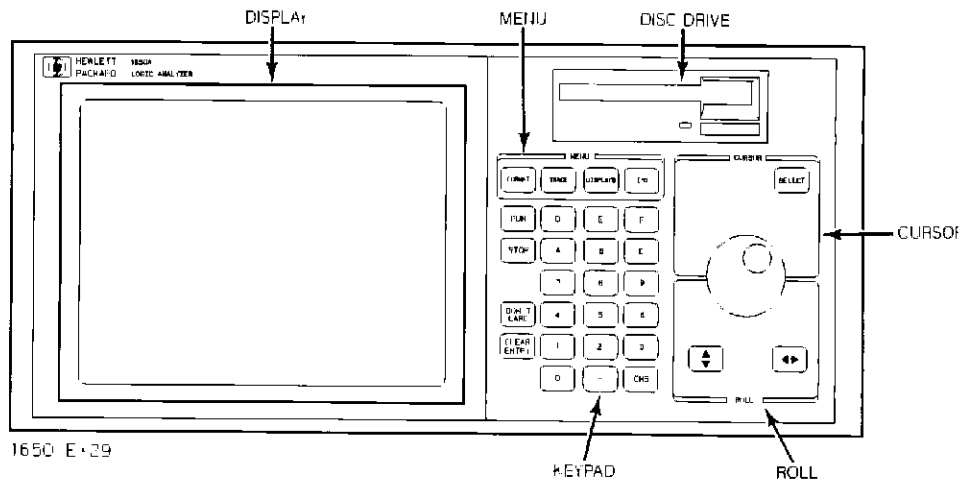

Cursor The CURSOR is a movable indicator on the display that allows you to access desired fields in each menu. It changes the field where it resides from the normal white background to the dark background (inverse video). The KNOB moves the cursor to the field (function) you wish to use. You activate the field (function) by pressing the **SELECT** key

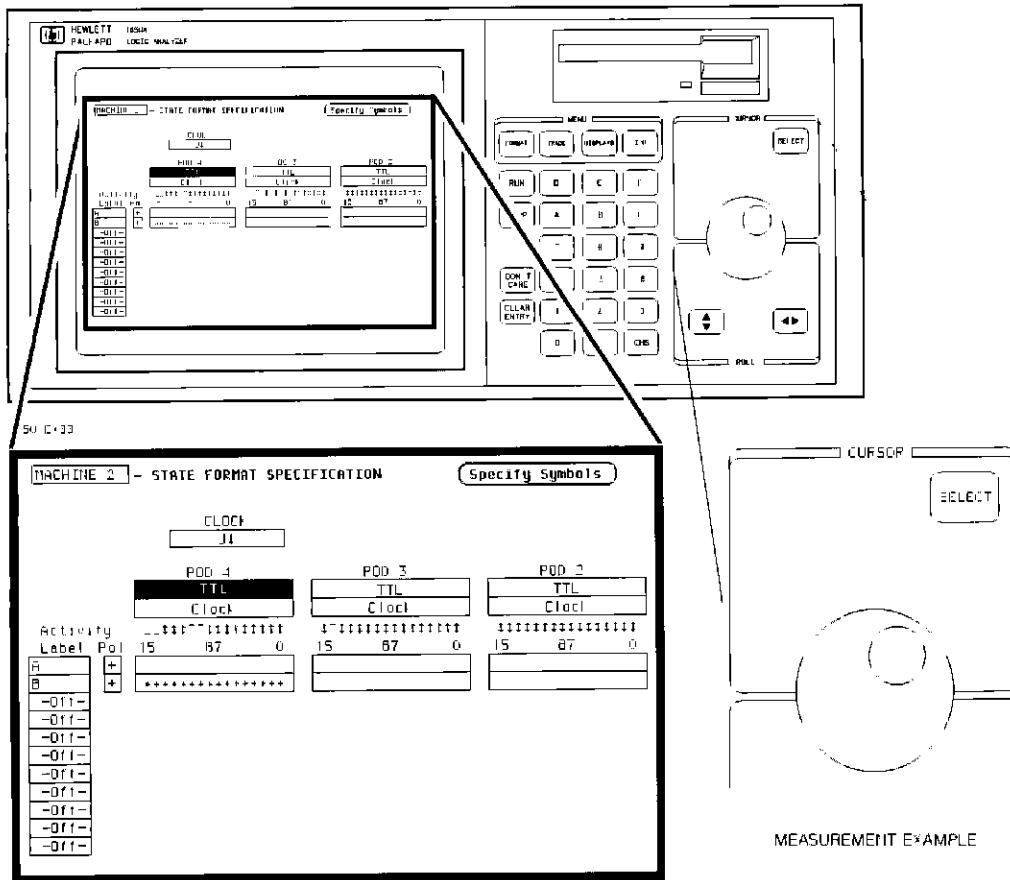

Getting to Know the Front Panel
2-2

Keypad The keypad allows you start and stop data acquisition as well as enter alphanumeric data. Also in the keypad area are the **DON'T CARE** and **CLEAR ENTRY** keys

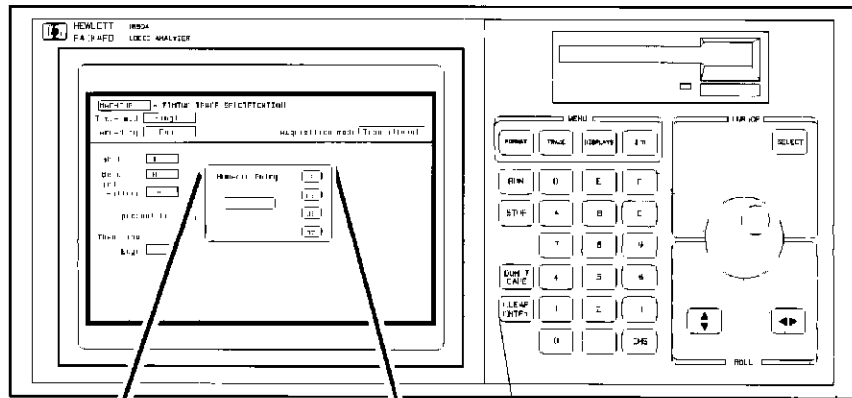

1850 E+32

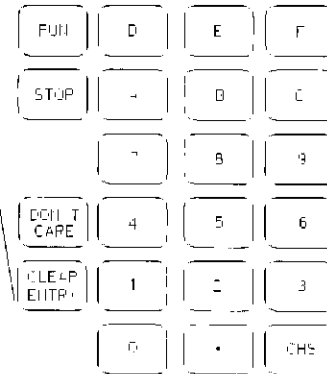
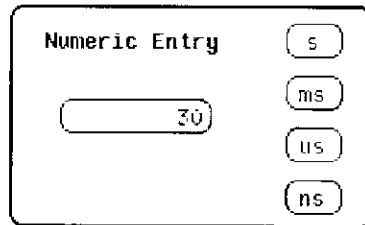

Roll When part of the data display is off screen, the **ROLL** keys define which way the **KNOB** will move the displayed data. You will use these keys and the **KNOB** to roll displayed data up/down or left/right to view data that is off screen

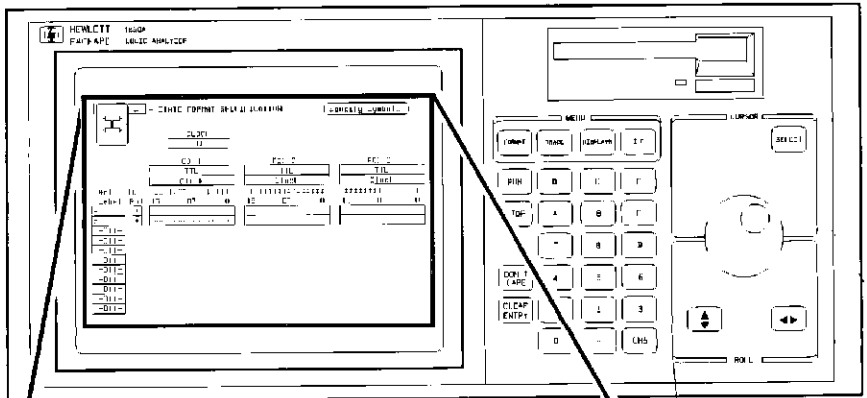

11 J E 34

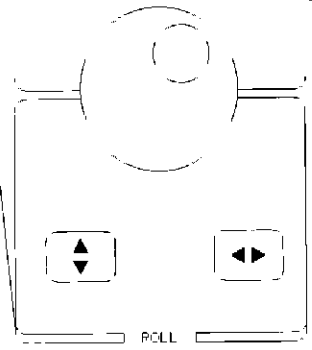
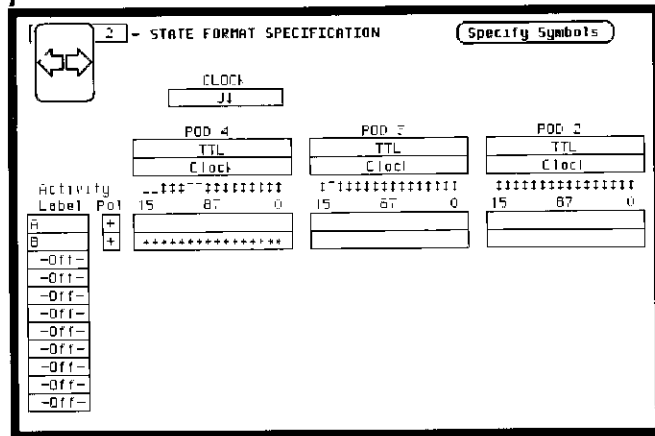

Menu The MENU area contains keys that give you access to the four major menus of the logic analyzer. You use this area to:

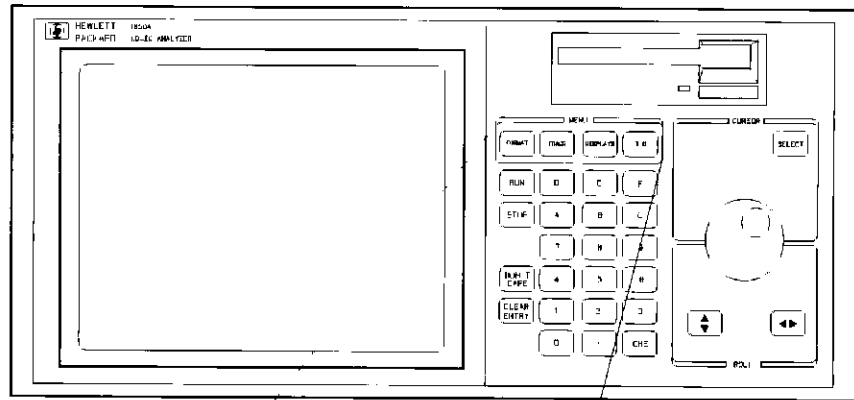

1650 E-31

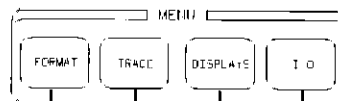

- Access disc drive functions and set up the analyzer for use with a printer or controller
- Choose how the acquired data will be displayed
- Specify how and when each analyzer type will acquire data for your measurement
- Select the timing/state format specification menus where you assign names to channels

Getting to Know the Front Panel

2-5

Display The display shows you the menus for configuring the logic analyzer and the results of your measurements.

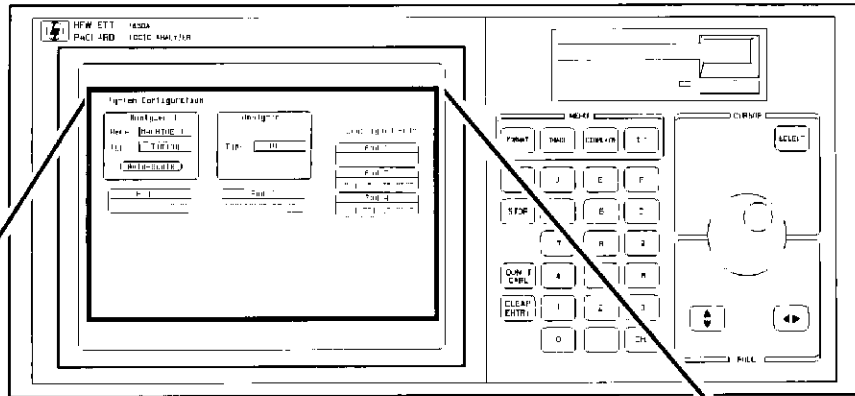

1650 E-29

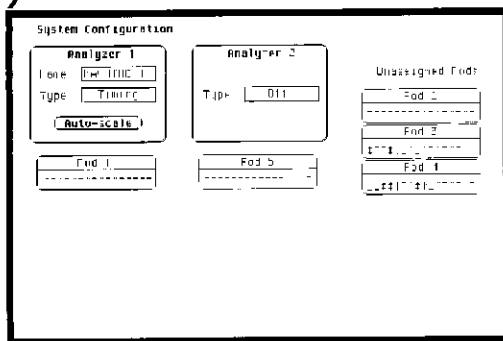

MENU EXAMPLE

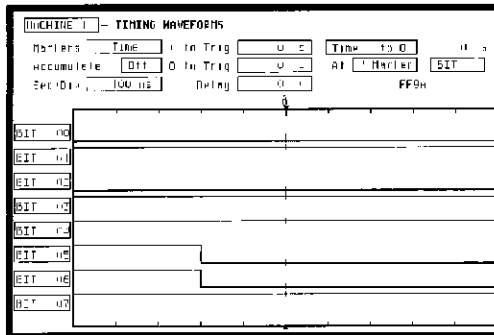

MEASUREMENT EXAMPLE

Disc Drive The logic analyzer uses the disc drive every time you turn on the logic analyzer to load its operating system. The disc drive uses 3.5-inch flexible discs. You can also use the disc drive to store instrument configurations, acquired data, and inverse assemblers for later use. Complete details on the disc drive and its functions can be found in the *HP 1650A/51A Reference Manual*.

Summary

Now that you are acquainted with the front panel organization, you will be able to decide where you want to go next. If you are just starting to learn logic analysis, you should read this entire manual. If you are experienced in logic analysis, you should continue to read chapters 2 through 4 to become more familiar with the operation of the front panel before you turn to the reference manual. These chapters will show you how easy the HP 1650A/51A logic analyzers are to operate.



3

How Do I Use the Front Panel?

Introduction

In this chapter you will learn how easy the HP 1650A/51A logic analyzer front panel controls are to use. You will also learn the front panel by following self-paced exercises.

This chapter starts you off in the System Configuration menu, the same place the logic analyzer starts after you turn it on. You will learn how easy it is to get in and out of this menu. You will also learn what the shapes of the menu fields mean.

Don't be concerned about not seeing measurement examples in this chapter. You will see them in chapters 5 through 8.

Menu Field Conventions

Before starting to work with the menus, you need to know the two menu field conventions. This allows you to quickly recognize what type of action will occur when you select a field.

There are two shapes that you should become familiar with: rectangles with square corners and rectangles with rounded corners.

When you select a field with rectangular corners, it pops up and lists two or more items. You must select a single item.

Fields with rounded corners will either execute the function immediately or pop up with a list of multiple items that you must specify.

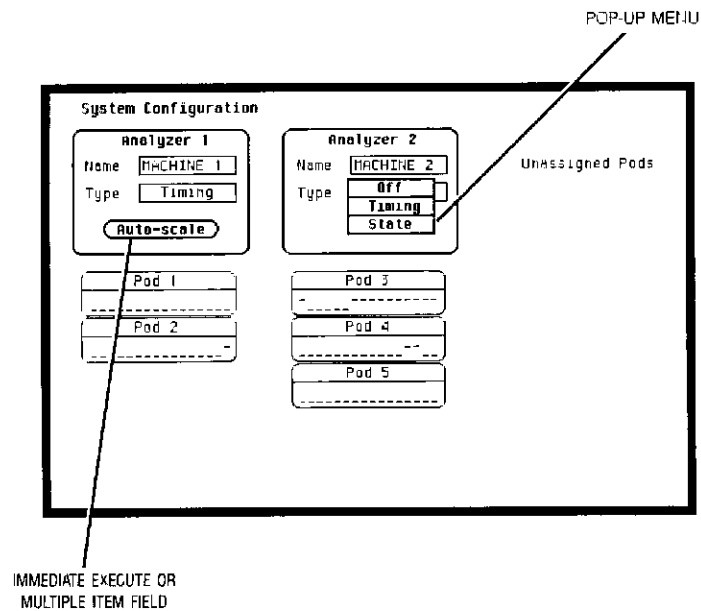

How Do I Use the Front Panel?
3-2

Your First Step

When you turn on the logic analyzer and the operating system has finished loading, you will see the System Configuration menu. Notice the cursor is in one of the fields in this menu. Operating the HP 1650A/51A front panel is like learning to drive a car.

System Configuration

| Analyzer 1 | Analyzer 2 | Unassigned Pod: |
|-----------------|------------|-----------------|
| Name: MACHINE 1 | Type: Off | Pod 2 |
| Type: Timing | | Pod 3 |
| Auto-scale | | Pod 4 |
| Pod 1 | Pod 5 | |

To "drive" around the menu, turn the **KNOB** and watch the cursor move from field to field. Most of the logic analyzer operation is accomplished by placing the cursor on the field you want to interact with and pressing the **SELECT** key. Depending on the field type (immediate execute or pop-up) pressing **SELECT** will either execute a function or open a pop-up menu.

Note

*This is the HP 1650A System Format Specification menu. If you have an HP 1651A, the only difference is pod 1 will be assigned to analyzer 1 and pod 2 will be assigned to analyzer 2. There won't be any pods in the **UNASSIGNED** area of the display.*

How Do I Use the Front Panel?

3-3

Returning to the System Configuration Menu

When you leave the System Configuration menu, you can return to it at any time by following these steps:

1. Press either the **FORMAT**, **TRACE**, or **DISPLAY** key. You now see a new menu. All three of these menus have a field in the upper left corner. This field will display either **MACHINE 1** or **MACHINE 2** depending on how the logic analyzer was configured.
2. Place the cursor on this field and press **SELECT**. You will see the following pop-up menu.
3. Place the cursor on **System** and press **SELECT**. You will be returned to the System Configuration menu.

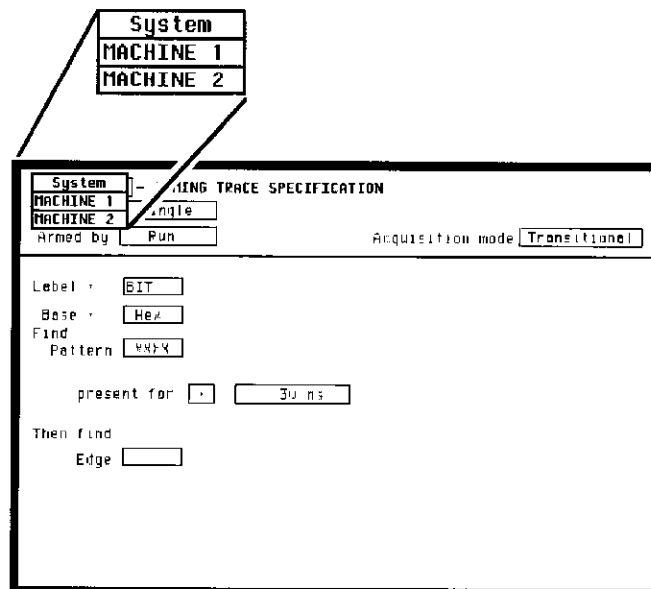

How Do I Use the Front Panel?
3-4



Exploring the System Configuration Menu

Now is a good time to explore the System Configuration menu by driving the cursor around and pressing **SELECT**. Don't worry, you can't hurt anything because no matter what field you select you will have an easy way out.

For example, select the Name: MACHINE 1 field, and you will see a pop-up that you can use to name analyzer number 1. In this pop-up menu you will see a field named **Done** that lets you get out of this menu and back to the System Configuration menu where you started.

If you select **Auto-scale**, the logic analyzer will display a pop-up with the choices of **Cancel** and **Continue**. The **Cancel** allows you to change your mind before the auto-scale is executed. This is handy because auto-scale will **change** your previous configurations.

If you select **Continue**, the logic analyzer will display the TIMING WAVEFORMS menu. However, if there is no signal activity at the probes, the Waveforms menu will not display data and the label to the left of the waveform area will be **-off**.

To get back to the System Configuration menu after executing **Auto-scale**:

1. Place the cursor on the field in the upper left corner and press **SELECT**.
2. Place the cursor on **System** in the pop-up and press **SELECT**. You will now be back in the System Configuration menu.

Closing Pop-up Menus

In previous exercises, you closed the **Alpha Entry** pop-up by using the **Done** field. But, what if there is no **Done** in the other fields? Fields that don't have choices like **Done**, **Cancel**, or **Exit** will close automatically when you make your selection. For example, you have used this type of pop-up to get back to the System Configuration menu.

To see another example of a pop-up that automatically closes, follow these steps:

1. Rotate the **KNOB** until the cursor is on the **Off** field in the **ANALYZER 2** field, then press **SELECT**. You will now see the following pop-up:

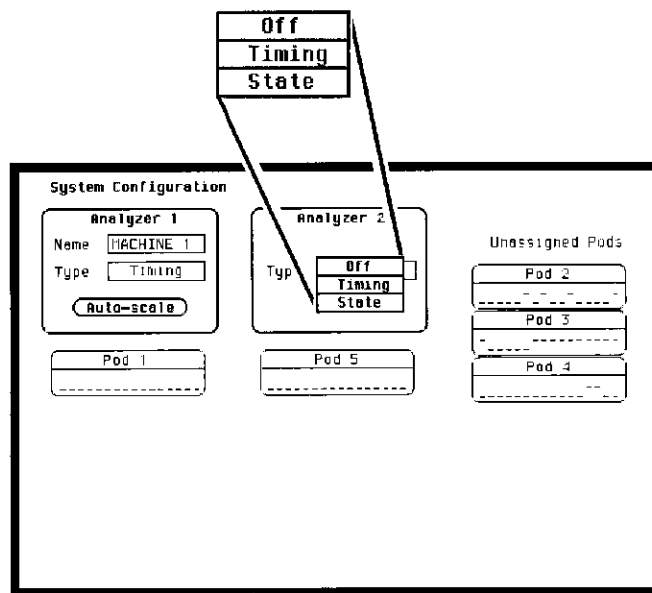

2. Place the cursor on **State** and press **SELECT**.

The pop-up menu will automatically close, analyzer 2 is now on and the type will be State.



Summary

In this chapter you learned what menu the logic analyzer displays once you have turned it on and where you will usually start configuring the logic analyzer once you are ready to make measurements

The next chapter will teach you the most common types of pop-up menus, which will help you progress towards making measurements as explained in chapters 5 through 7.

4

Learning the Basic Menus

Introduction

In this chapter you will learn the most common pop-up menu types by doing some basic exercises. The pop-up menu types you will learn in this chapter are:

- Selector
 - Alpha Entry
 - Numeric Entry
 - Assignment/Specification
-

Selector Pop-up Menu

In the selector type of pop-up menu you do what the name implies, make a selection from two or more options. The best way to introduce you to a selector type of menu is to have you work with one right away.

Switching Between Analyzers

You will use a selector type of pop-up menu to switch between analyzers or get back to the System Configuration menu. You can switch analyzers in the FORMAT, TRACE and DISPLAY menus, without having to go back to the System Configuration menu. This is done easily by following these steps:

- 1 Press the **TRACE** key. You will now be in either the TIMING TRACE or STATE TRACE SPECIFICATION menu depending on what you did last in the System Configuration menu.

- Place the cursor in the field in the upper left corner of the menu and press **SELECT**. A pop-up menu will appear displaying **System** and the current analyzer names (default names are **MACHINE 1** and **MACHINE 2**). The cursor will be on the current analyzer.

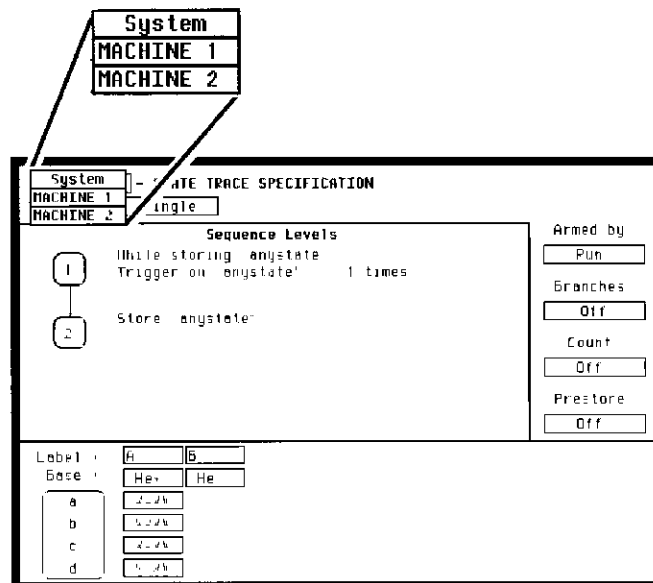

- Move the cursor to the other machine (analyzer) and press **SELECT**. The pop-up will close and you will see the corresponding menu of the other analyzer on the display.

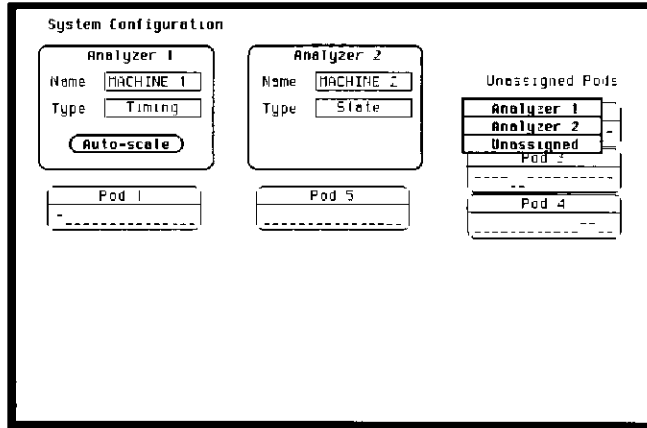

3. Place the cursor on Analyzer 2 and press **SELECT**. The pop-up closes and your desired pod is now assigned to analyzer 2.

- 1 Get back to the System Configuration menu (refer to "Returning to the System Configuration Menu" in chapter 3 if you need a reminder).
- 2 Rotate the **KNOB** until the cursor is over **MACHINE 1** and press **SELECT**.

You will now see a pop-up window in the System Configuration menu as shown in the example

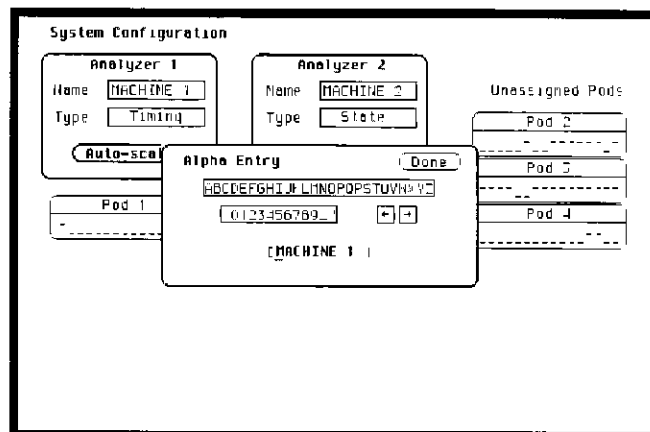

3. Rotate the **KIIOB** and you will see how the cursor moves within the pop-up

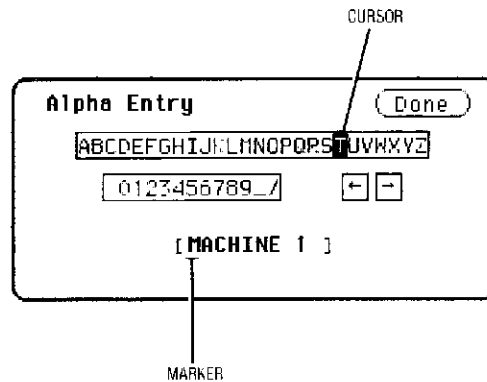

4. Now that you are ready to name analyzer 1, move the cursor so that it is on the L and press **SELECT**.

In the bottom of the pop-up, you will see an **L** in the far left corner of the bottom box. Also notice the under-score marker in the bottom box is now under the **A** of **MACHINE**. The under-score marker tells you in what space in the box your next selection will be placed.

5. Rotate the **KIIOB** again until you have placed the cursor over the **E**, then press **SELECT**.

Note

You can also make direct keypad entries. Your selection will be placed where the under-score marker is in the box.

6 Repeat step 5 three more times selecting A, R, and M respectively.

You should now see LEARMNE 1 in the bottom box. Since this is not the name you wanted, change the name.

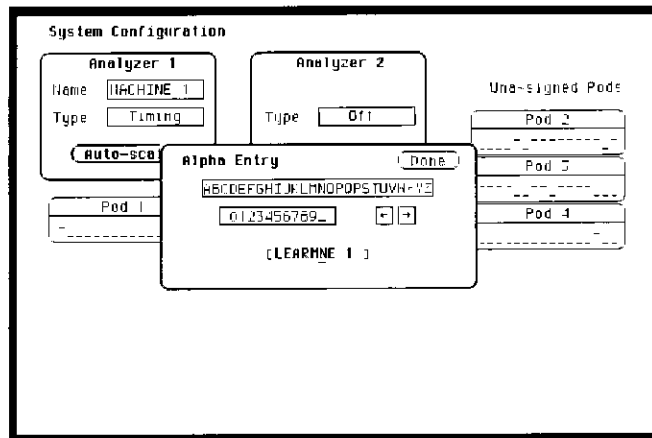

Changing Alpha Entries

To make changes or corrections in the Alpha Entry field, place the under-score marker under the character you want to change.

To move the under-score marker to the left, place the cursor over the left arrow and press **SELECT** once for each backspace.

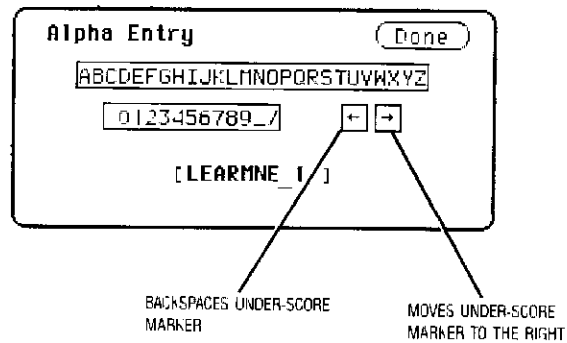

To move the under-score marker to the right, you either place the cursor on a desired character and press **SELECT**, or place it on the right arrow and press **SELECT**.

You can also use the **ROLL** keys and the **KNOB** to move the under-score marker. To use this alternate method:

1. Press the left/right **ROLL** key.
2. Rotate the **KNOB** to place the under-score marker under the desired character
3. Press the left/right **ROLL** key again to turn off the **ROLL** function.

If you want to erase the entire entry and place the under-score marker at the beginning of the name box, press the **CLEAR ENTRY** key on the front panel.

If you want to replace a character with a space, place the under-score marker under that character and press the **DON'T CARE** key on the front panel.

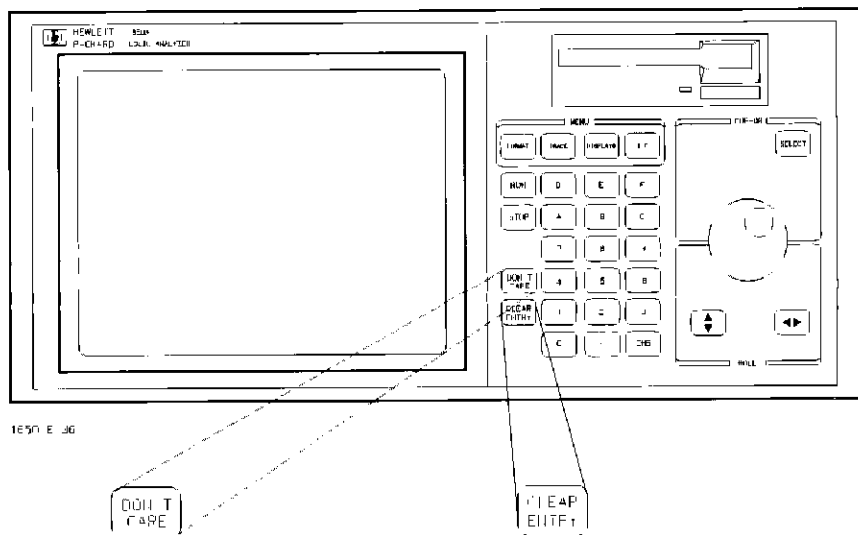

Now that you have entered and edited a name, you will know how to use the Alpha Entry pop-up menu in other logic analyzer menus where it appears.

Numeric Entry Menus

There are many pop-up menus in which you enter numeric data. The two major types are:

- Numeric entry with fixed units (i.e. volts)
- Numeric entry with variable units (i.e. ms, μ s, etc.)

There are several numeric entry menus in which you only enter the value, and the units are fixed. One such type of numeric entry pop-up is the POD Threshold pop-up menu.

Besides being able to set the pod thresholds to either of the preset thresholds (TTL or ECL), you can set the thresholds to a specific voltage from -9.9 V to $+9.9$ V.

To set pod thresholds to a specific voltage, follow these steps:

1. Select either the **TIMING** or **STATE FORMAT SPECIFICATION** menu by pressing the **FORMAT** key. It doesn't matter whether you are in the **TIMING** or **STATE FORMAT SPECIFICATION** menu.
2. Rotate the **KNOB** to place the cursor in the **TTL** field of any pod displayed and press **SELECT**. You will now see a pop-up with the choices, **TTL**, **ECL**, and **User defined**.

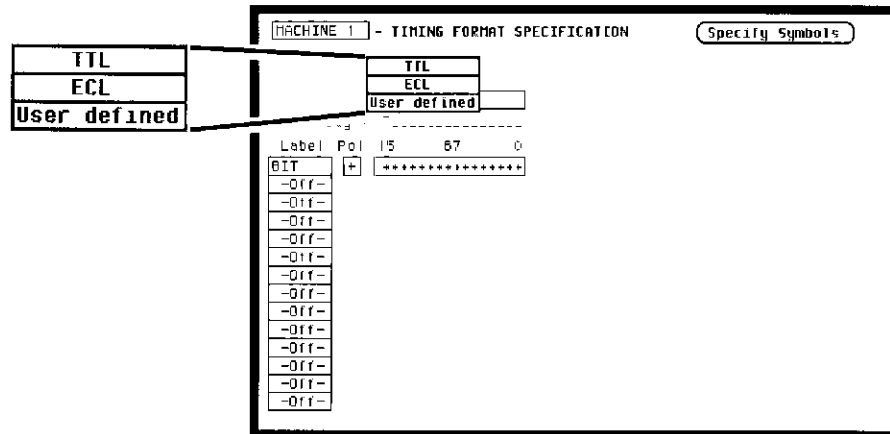

- Place the cursor on **User Defined** and press **SELECT**. Another pop-up menu will appear as shown.

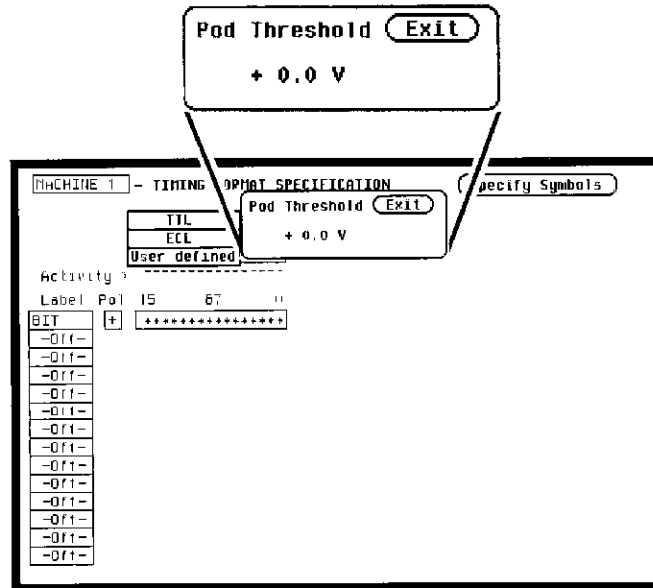

You can enter your desired threshold with either of two methods when the pod threshold pop-up is open. The first method is to rotate the **KNOB** until your desired threshold is displayed. Rotating the **KNOB** increments or decrements the value in small increments.

The second method is to use the keypad, which allows you to change large values quickly. With the keypad follow these simple steps to enter **-5.0 V** for the pod threshold:

- Enter 5.0 from the keypad. You will see the 0.0 V replaced with 5.0

5. Press the **CHS** (change sign) key on the front panel. You will now see -5.0 in the pop-up.

Also notice the cursor is in the upper right corner of the pop-up over the operative **Exit**. When you press **SELECT**, the pop-up will close and your new threshold will be placed in the Pod field.

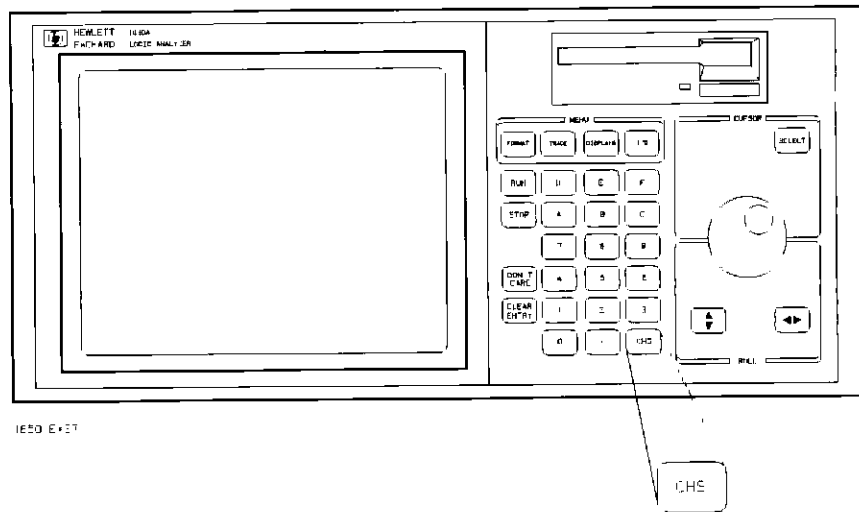

Another type of numeric entry you will use requires you to specify the units as well as the numeric value. The following steps show you how:

1. Select the **TIMING TRACE SPECIFICATION** menu by pressing the **TRACE** key.

Note

*If the **STATE TRACE SPECIFICATION** menu comes up, refer to "Switching Between Analyzers" in this chapter.*

2. Rotate the **KNOB** to place the cursor in the **30 ns** box within the **present for > 30 ns** line and press **SELECT**. You will now see the following pop-up:

MACHINE 1 - TIMING TRACE SPECIFICATION

Trace mode: Single
Armed by: Run
Acquisition mode: Transitional

Label: BIT
Base: Hex
Find Pattern: 0100
present for: .
Then find Edge

Numeric Entry: 30.00
Units: s, ms, us, ns

- 3 Enter a new value to replace 30.00 with the keypad. When you have entered your desired value, you can change the units type by rotating the **KNOB**.

Once you have selected the new value and the units, close the pop-up by pressing **SELECT**. The new value and the units will now be displayed in the **present for > _____** field.

Assignment/ Specification Menu

There are a number of pop-up menus in which you assign or specify what you want the logic analyzer to do. The basic menus of this type consist of

- Assigning bits to pods
- Specifying patterns
- Specifying edges

Assigning Bits to Pods

The bit assignment fields in both state and timing analyzers work identically. Before starting this exercise you need to know how the logic analyzer knows which bits are assigned and which ones are not assigned. The convention for bit assignment is:

- * (asterisk) indicates assigned bits.
- . (period) indicates un-assigned bits.

In the following menu example, bits 0 through 7 are assigned to the label **BIT**.

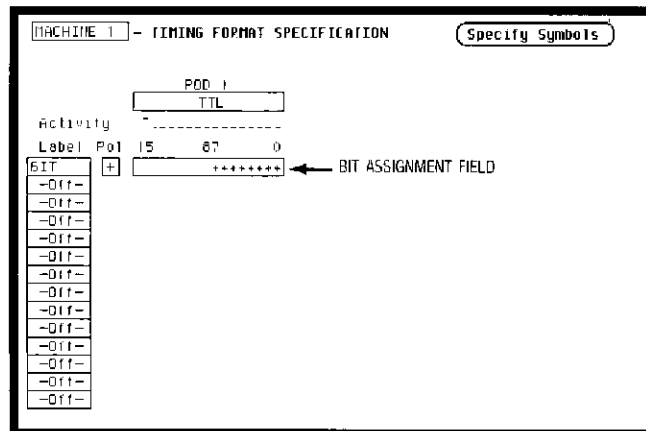

To assign bits:

1. Select either the **TIMING** or **STATE FORMAT SPECIFICATION** menu.

- Place the cursor on one of the bit assignment fields and press **SELECT**. You will see the following pop-up menu.

Note

If you don't see any bit assignment fields, it merely means you don't have any pods assigned to this analyzer. Either switch analyzers or assign a pod to the analyzer you are working with.

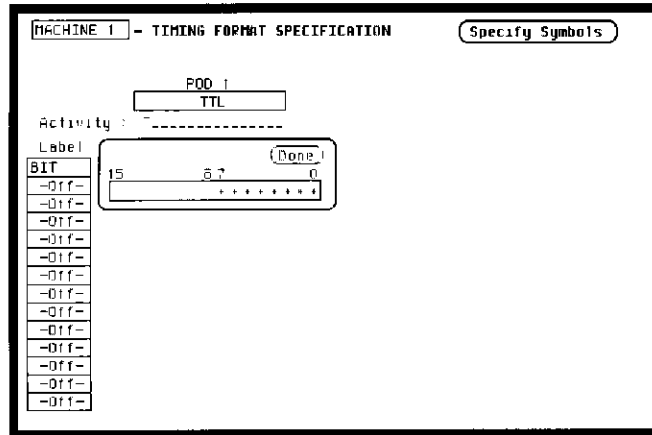

- Rotate the **KNOB** to place the cursor on one of the asterisks or periods in the pop-up and press **SELECT**. You will notice how the bit assignment toggles to the opposite state of what it was when the pop-up opened.

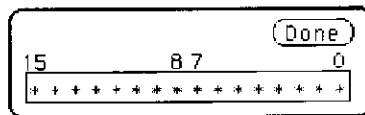

- You close the pop-up by placing the cursor on **Done** and pressing **SELECT**.

Specifying Patterns

The Specify Patterns fields appear in several menus in both the timing and state analyzers. Patterns can be specified in one of several number bases; however, for now we'll use hexadecimal (HEX) since it is the default base.

Before starting this exercise you need to know how the logic analyzer knows which patterns to ignore (doesn't care about). Whenever you see an "X" in this type of menu, it indicates a "don't care."

To specify patterns:

1. Select the TIMING TRACE SPECIFICATION menu.
2. Place the cursor on the **Find Pattern** _____ field and press **SELECT**. You will see the following pop-up menu.

MACHINE 1 - TIMING TRACE SPECIFICATION

Trace mode Armed by Acquisition mode

Label
Base
Find Pattern **Specify Pattern:**

present for

Then find
Edge

3. Type in 2, 3, 4, and press the **DON'T CARE** key. You will see 234X in the pop-up. This will be the pattern in hexadecimal that you want the logic analyzer to recognize.
4. Close the pop-up by pressing **SELECT**.

Specifying Edges

You specify edges in the TIMING TRACE SPECIFICATION menu by following these steps:

1. Press the **TRACE** key. Switch to the timing analyzer if the STATE TRACE SPECIFICATION menu is displayed
2. Place the cursor on the **Then find Edge . .** field under one of the labels and press **SELECT**. The following pop-up will appear.

MACHINE 1 - TIMING TRACE SPECIFICATION
Trace mode: Single
Armed by: Pulse
Acquisition mode: Transitional
Label: BIT
Base: Hex
Find Pattern: 374k
present for: 30 ns
Then find Edge:
Specify Edge: Done
1

You will notice 16 periods in the pop-up menu. Each period represents an unassigned bit for each bit assigned to the label. Don't be alarmed if you have a different number of unassigned bits; it merely means the number of bits in your label is different than the label in this example.

Specify Edge: Done
1

3. Place the cursor on one of the unassigned bit periods and press **SELECT** once. You will now see an arrow pointing down.

Specify Edge:
 1.f.

Specify Edge:
 1.f. t... ..

4. Move the cursor to another unassigned bit period and press **SELECT** twice. You will see an arrow pointing up.
5. Move the cursor to yet another unassigned bit period and press **SELECT** three times. You will see an arrow pointing both up and down

You have just selected a positive-going (↑), negative-going (↓), and either edge (↑↓) for your edge parameter.

6. Place the cursor on **Done** and press **SELECT**. The pop-up will close and you will see the following display.

MACHINE 1 - TIMING TRACE SPECIFICATION

Trace mode Acquisition mode

Armed by

Label

Base

Find Pattern

present for

Then find Edge

Note

When you close the pop-up after specifying edges, you will see dollar signs (\$ \$. .) in the Then find Edge field. These indicate edges have been specified; however, the logic analyzer can't display them correctly unless you have selected Binary for the base.

Summary

In this chapter you have learned some of the most common pop-up menu types. You will use these pop-up menus as you set up the logic analyzer in the measurement example exercises in chapters 5 through 7.

If you are already familiar with logic analysis and feel you are comfortable enough with the HP 1650A/51A user interface, you may be ready for the *HP 1650A/51A Reference Manual*.

If you are not familiar with logic analyzers or logic analysis, you should continue with this manual.

5

Using the Timing Analyzer

Introduction

In this chapter you will learn how to use the timing analyzer by setting up the logic analyzer to make a simple measurement. We give you the measurement results as actually measured by the logic analyzer, since you may not have the same circuit available.

The exercise in this chapter is organized in a task format. The tasks are ordered in the same way you will most likely use them once you become an experienced user. The steps in this format are both numbered and lettered. The numbered steps state the step objective. The lettered steps explain how to accomplish each step objective. There is also an example of each menu after it has been properly set up.

How you use the steps depends on how much you remember from chapters 1 through 4. If you can set up each menu by just looking at the menu picture, go ahead and do so. If you need a reminder of what steps you need to perform, follow the numbered steps. If you still need more information about "how," use the lettered steps.

When you have finished configuring the logic analyzer for this exercise, you can load a file from the operating system disc. This file configures the logic analyzer the same way it is configured for this exercise. It also loads the same data acquired for this exercise so you can see what it looks like on screen.

In order to learn how to configure the logic analyzer, we recommend that you follow the exercise to "Acquiring the Data" before loading the file from the disc.

You can also compare your configuration with the one on the disc by printing it (if you have a printer) or making notes before you load the file.

Problem Solving with the Timing Analyzer

In this exercise, assume you are designing a dynamic RAM memory (DRAM) controller and you must verify the timing of the row address strobe (RAS) and the column address strobe (CAS). You are using a 4116 dynamic RAM and the data book specifies that the minimum time from when LRAS is asserted (goes low) to when LCAS is no longer asserted (goes high) is 250 ns. You could use an oscilloscope but you have an HP 1650A/51A on your bench. Since the timing analyzer will do just fine when you don't need voltage parametrics, you decide to go ahead and use the logic analyzer.

What Am I Going to Measure?

After configuring the logic analyzer and hooking it up to your circuit under test, you will be measuring the time (x) from when the RAS goes low to when the CAS goes high, as shown below.

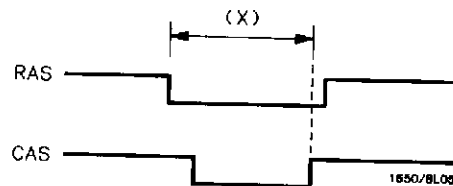

How Do I Configure the Logic Analyzer?

In order to make this timing measurement, you must configure the logic analyzer as a timing analyzer. By following these steps you will configure Analyzer 1 as the timing analyzer.

If you are in the System Configuration menu you are in the right place to get started and you can start with step 2; otherwise, start with step 1.

1. Using the field in the upper left corner of the display, get the System Configuration menu on screen.
 - a. Place the cursor on the field in the upper left corner of the display and press **SELECT**.
 - b. Place the cursor on **System** and press **SELECT**.
2. In the System Configuration menu, change Analyzer 1 type to **Timing**. If analyzer 1 is already a timing analyzer, go on to step 3.
 - a. Place the cursor on the **Type:** _____ field and press **SELECT**.
 - b. Place the cursor on **Timing** and press **SELECT**.

The screenshot shows the 'System Configuration' menu. It contains two analyzer configuration boxes and a list of pods. Analyzer 1 has 'Name' set to 'OPRM TEST' and 'Type' set to 'Timing'. There is an 'Auto-scale' button below the Type field. Analyzer 2 has 'Type' set to 'Off'. To the right, under 'Unsigned Pods', there are five pod entries labeled 'Pod 2' through 'Pod 5'. Below the analyzer boxes, there is a 'Pod 1' entry.

3. Name Analyzer 1 "DRAM TEST" (optional)

- a. Place the cursor on the **Name:** _____ field of Analyzer 1 and press **SELECT**.
- b. With the Alpha Entry pop-up, change the name to "DRAM TEST" (see "Alpha Entry Pop-up Menu" in chapter 4 if you need a reminder).

4. Assign pod 1 to the timing analyzer:

- a. Place the cursor on the **Pod 1** field and press **SELECT**.
- b. In the Pod 1 pop-up, place the cursor on **Analyzer 1** and press **SELECT**.

Connecting the Probes

At this point, if you had a target system with a 4116 DRAM memory IC, you would connect the logic analyzer to your system. Since you have assigned labels and Pod 1 bits 0 and 1, you hook the probes to your system accordingly.

Since you will be assigning Pod 1 bit 0 to the RAS label, you hook Pod 1 bit 0 to the memory IC pin connected to the RAS signal. You hook Pod 1 bit 1 to the IC pin connected to the CAS signal.

Activity Indicators

When the logic analyzer is connected and your target system is running, you will see ↓ at the right-most end (least significant bits) of the Pod 1 field in the System Configuration menu. This indicates the RAS and CAS signals are transitioning.

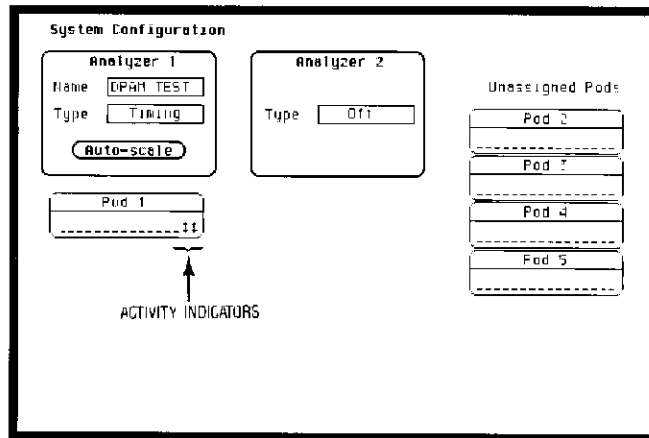

Configuring the Timing Analyzer

Now that you have configured the system, you are ready to configure the timing analyzer. You will be:

- Creating two names (labels) for the input signals
 - Assigning the channels connected to the input signals
 - Specifying a trigger condition
1. Display the TIMING FORMAT SPECIFICATION menu.
 - a. Press the **FORMAT** key on the front panel.
 2. Name two labels, one RAS and one CAS.
 - a. Place the cursor on the top field in the label column and press **SELECT**.
 - b. Place the cursor on **Modify label** and press **SELECT**.

OPHM TEST - TIMING FORMAT SPECIFICATION Specify Symbols

POD 1
TTL
Activity -----11

| Label | Pol | 15 | 07 | 0 |
|-------|-----|----|----|---|
| PHS | + | | | + |
| CAS | + | | | + |
| -Off- | | | | |
| -Off- | | | | |
| -Off- | | | | |
| -Off- | | | | |
| -Off- | | | | |
| -Off- | | | | |
| -Off- | | | | |
| -Off- | | | | |
| -Off- | | | | |
| -Off- | | | | |
| -Off- | | | | |
| -Off- | | | | |
| -Off- | | | | |
| -Off- | | | | |



- c. With the Alpha Entry pop-up, change the name of the label to RAS (see "Alpha Entry Pop-up Menu" in chapter 4 if you need a reminder)
 - d. Name the second label CAS by repeating steps a through c.
3. Assign the channels connected to the input signals (Pod 1 bits 0 and 1) to the labels RAS and CAS respectively.
- a. Place the cursor on the bit assignment field below Pod 1 and to the right of RAS and press **SELECT**.
 - b. Any combination of bits may be assigned to this pod; however, you will want only bit 0 assigned to the RAS label. The easiest way to assign bits is to press the **CLEAR ENTRY** key to un-assign any assigned bits before you start.
 - c. Place the cursor on the period under the 0 in the bit assignment pop-up and press **SELECT**. This will place an asterisk in the pop-up for bit 0 indicating Pod 1 bit 0 is now assigned to the RAS label. Place cursor on **Done** and press **SELECT** to close the pop-up.
 - d. Assign Pod 1 bit 1 to the CAS label by moving the cursor to bit 1 and pressing **SELECT**.

Specifying a Trigger Condition

To capture the data and then place the data of interest in the center of the display of the TIMING WAVEFORMS menu, you need to tell the logic analyzer when to trigger. Since the first event of interest is when the LRAS is asserted (negative-going edge of RAS), you need to tell the logic analyzer to trigger on a negative-going edge of the RAS signal.

1. Select the TIMING TRACE menu by pressing the **TRACE** key.
2. Set the trigger so that the logic analyzer triggers on the negative-going edge of the RAS.
 - a. Place the cursor on the **Then find Edge** field under the label RAS, then press **SELECT**.
 - b. Place the cursor on the . (period) in the pop-up and press **SELECT** once. Pressing **SELECT** once in this pop-up changes a period to ↓ which indicates a negative-going edge.
 - c. Place the cursor on **Done** and press **SELECT**. The pop-up closes and a \$ will be located in this field. The \$ indicates an edge has been specified even though it can't be shown in the HEX base.

The screenshot shows a menu titled "TIMING TRACE SPECIFICATION" with the following fields and options:

- Trace mode: Single
- Armed by: Pin
- Acquisition mode: Transitional
- Label: PRS CAS
- Base: He> He<
- Find Pattern: ↓
- present for: TO INE
- Then find Edge: \$

Acquiring the Data

Now that you have configured and connected the logic analyzer, you acquire the data for your measurement by pressing the **RUN** key. The logic analyzer will look for a negative edge on the RAS signal and trigger if it sees one. When it triggers, the display switches to the **TIMING WAVEFORMS** menu.

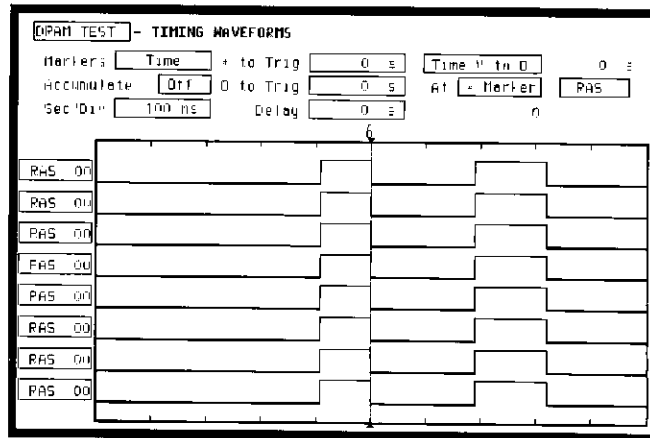

If this is the first time you have acquired data and you have not previously set up the **TIMING WAVEFORMS** menu, you will see eight labels named **RAS**. Don't worry, this is normal. To turn on the **CAS** label and delete the other six **RAS** labels, follow these steps:

1. Place the cursor on the second **RAS** label and press **SELECT**.
2. Place the cursor on **Modify waveform** and press **SELECT**. A pop-up appears showing you the choices, **RAS** and **CAS**.

3. Place the cursor on **CAS** and press **SELECT**. The pop-up closes and replaces the second **RAS** label with **CAS**.
4. Place the cursor on the third label (**RAS**) and press **SELECT**.
5. Place the cursor on **Delete waveform** and press **SELECT**. This deletes the label in which you opened this pop-up menu. Repeat this step until you have deleted the rest of the **RAS** labels

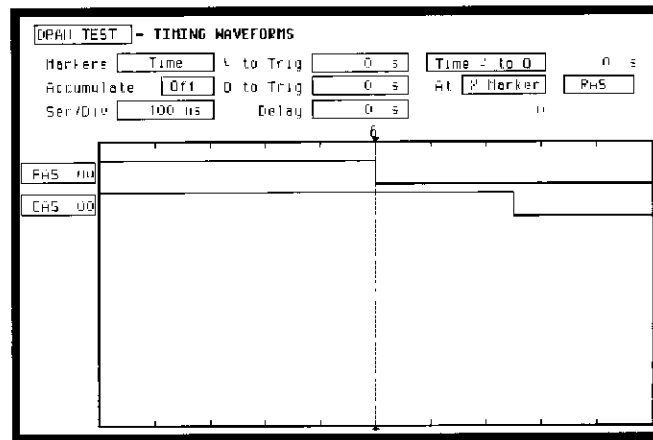

The RAS label shows you the RAS signal and the CAS label shows you the CAS signal. Notice the RAS signal goes low at or near the center of the waveform display area (horizontal center).

Now is the time to load the timing measurement demo file from the disc if you wish. The file name is **TIMINGDEMO**. Follow the procedure in Appendix B to load the file.

The Timing Waveforms Menu

The TIMING WAVEFORMS menu differs from the other menus you have used so far in this exercise. Besides displaying the acquired data, it has menu fields that you use to change the way the acquired data is displayed and fields that give you timing answers. Before you can use this menu to find answers, you need to know some of the special symbols and their functions. The symbols are:

- The X and O
- The ▼
- The vertical dotted line

The X and O The X and O are markers you use to find your answer. You place them on the points of interest on your waveforms, and the logic analyzer displays the time between the markers. The X and O markers will be in the center of the display when X to trig(ger) and O to trig(ger) are both 0.000 s (see example below).

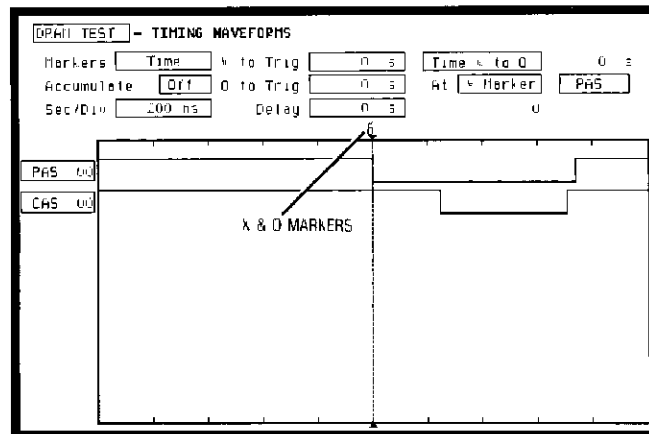

The ▼ The ▼ (inverted triangle) indicates the trace point. Remember, trace point = trigger + delay. Since delay in this example is 0.000 s, you will see the negative-going edge of the RAS signal at center screen under the ▼.

The Vertical Dotted Line The vertical dotted line indicates the trigger point you specified in the TIMING TRACE SPECIFICATION menu. The vertical dotted line is at center screen under the ▼ and is superimposed on the negative-going edge of the RAS signal.

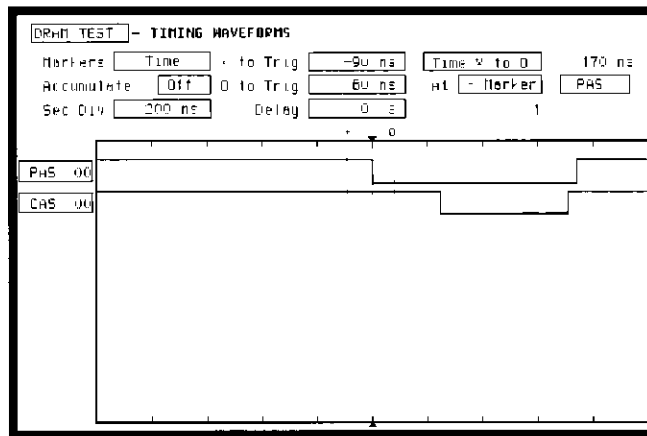

Configuring the Display

Now that you have acquired the RAS and CAS waveforms, you need to configure the TIMING WAVEFORMS menu for best resolution and to obtain your answer

Display Resolution

You get the best resolution by changing the **Sec/Div** to a value that displays one negative-going edge of both the RAS and CAS waveforms. Set the **Sec/Div** by following these steps.



1. Place the cursor on **Sec/Div** and press **SELECT**. The **Sec/Div** pop-up appears, showing you the current setting
2. While the pop-up is present, rotate the **KNOB** until your waveform shows you only one negative-going edge of the RAS waveform and one positive-going edge of the CAS waveform (see above). In this example 200 ns is best

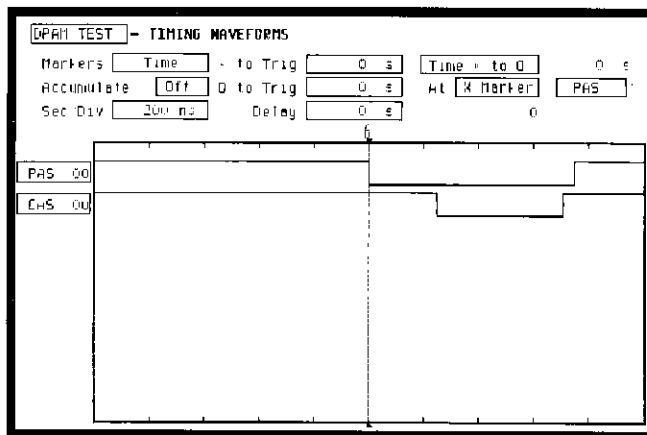

Making the Measurement

What you want to know is how much time elapses between the time RAS goes low and the time CAS goes high again. You will use the X and O markers to quickly find the answer. Remember, you specified the negative-going edge of the RAS to be your trigger point; therefore, the X marker should be on this edge if **X to Trig** = 0. If not, follow steps 1 and 2

- 1 Place the cursor on the **X to Trig** field and press **SELECT**. A pop-up will appear showing you the current time from the X marker to the trigger; however, you don't need to worry about this number now
- 2 Rotate the **KNOB** to place the X marker on the negative-going edge of the RAS waveform and press **SELECT**. The pop-up closes and displays **X to Trig** = 0.000 s.
- 3 Place the cursor on **O to Trig** and press **SELECT**. Repeat step 2 except place the O marker on the positive-going edge of the CAS waveform and press **SELECT**. The pop-up closes and displays **O to Trig** = 710 ns.

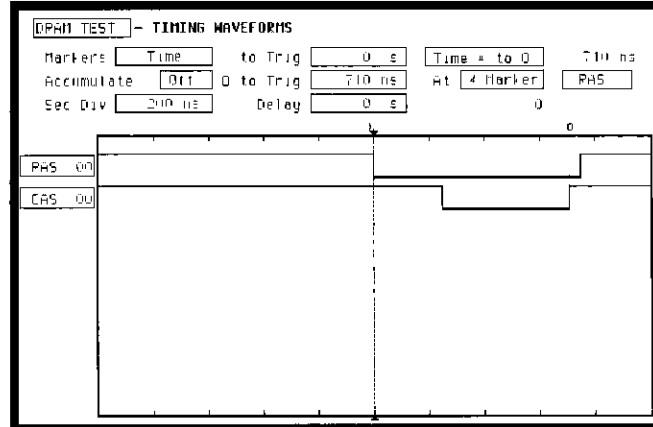

Finding the Answer

Your answer could be calculated by adding the **X to Trig** and **O to Trig** times, but you don't need to bother. The logic analyzer has already calculated this answer and displays it in the **Time X to O** _____ field.

This example indicates the time is 710 ns. Since the data book specifies a minimum of 250 ns, it appears your DRAM controller circuit is designed properly.

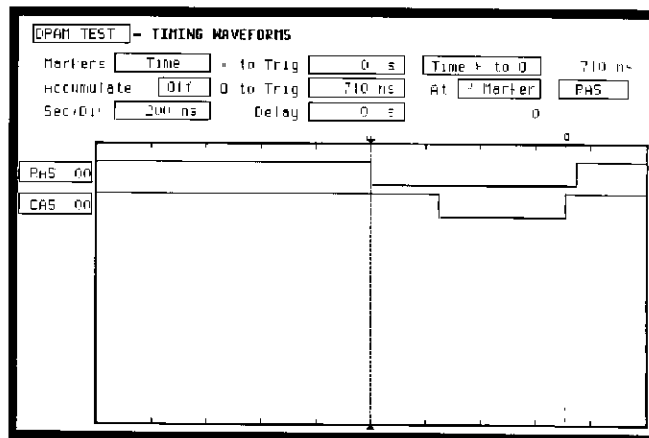

Summary

You have just learned how to make a simple timing measurement with the HP 1650A/51A logic analyzer. You have:

- specified a timing analyzer
- assigned pod 1
- assigned bits
- assigned labels
- specified a trigger condition
- learned which probes to connect
- acquired the data
- configured the display
- set the Sec/Div for best resolution
- positioned the markers for the measurement answer

You have seen how easy it is to use the timing analyzer to make timing measurements that you could have made with a scope. You can use the timing analyzer for any timing measurement that doesn't require voltage parametrics or doesn't go beyond the accuracy of the timing analyzer.

The next chapter teaches you how to use the state analyzer. You will go through a simple state measurement in the same way you did the timing measurement in this chapter.



Using the State Analyzer

Introduction

In this chapter you will learn how to use the state analyzer by setting up the logic analyzer to make a simple state measurement. We give you the measurement results as actually measured by the logic analyzer, since you may not have the same circuit available.

The exercise in this chapter is organized in a task format. The tasks are in the same order you will most likely use them once you become experienced. The steps in this format are both numbered and lettered. The numbered steps state the step objective. The lettered steps explain how to accomplish each step objective. There is also an example of each menu after it has been properly set up.

How you use the steps depends on how much you remember from chapters 1 through 4. If you can set up each menu by just looking at the menu picture, go ahead and do so. If you need a reminder of what steps to perform, follow the numbered steps. If you still need more information about "how," use the lettered steps.

When you have finished configuring the logic analyzer for this exercise, you can load a file from the operating system disc. This file configures the logic analyzer the same way it is configured for this exercise. It also loads the same data acquired for this exercise so you can see what it looks like on screen.

In order to learn how to configure the logic analyzer, we recommend that you follow the exercise to "Acquiring the Data" before loading the file from the disc.

You can also compare your configuration with the one on the disc by printing it (if you have a printer) or making notes before you load the file.

Problem Solving with the State Analyzer

In this example assume you have designed a microprocessor controlled circuit. You have completed the hardware, and the software designer has completed the software and programmed the ROM (read-only memory). When you turn your circuit on for the first time, your circuit doesn't work properly. You have checked the power supply voltages and the system clock and they are working properly.

Since the circuit has never worked before, you and the software engineer aren't sure if it is a hardware or software problem. You need to do some testing to find a solution.

What Am I Going to Measure?

You decide to start where the microprocessor starts when power is applied. We will describe a 68000 microprocessor; however, every processor has similar start-up routines.

When you power up a 68000 microprocessor, it is held in reset for a specific length of time before it starts doing anything to stabilize the power supplies. The time the microprocessor is held in reset ensures stable levels (states) on all the devices and buses in your circuit. When this reset period has ended, the 68000 performs a specific routine called "fetching the reset vector."

The first thing you check is the time the microprocessor is held in reset. You find the time is correct. The next thing to check is whether the microprocessor fetches the reset vector properly.

The steps of the 68000 reset vector fetch are:

1. Set the stack pointer to a location you specify, which is in ROM at address locations 0 and 2.
2. Find the first address location in memory where the microprocessor fetches its first instruction. This is also specified by you and stored in ROM at address locations 4 and 6.

What you decide to find out is:

1. What ROM address does the microprocessor look at for the location of the stack pointer, and what is the stack pointer location stored in ROM?
2. What ROM address does the microprocessor look at for the address where its first instruction is stored in ROM, and is the instruction correct?
3. Does the microprocessor then go to the address where its first instruction is stored?
4. Is the executable instruction stored in the first instruction location correct?

Your measurement, then, requires verification of the sequential addresses the microprocessor looks at, and of the data in ROM at these addresses. If the reset vector fetch is correct (in this example), you will see the following list of numbers in HEX (default base) when your measurement results are displayed.

```
+0000 000000 0000  
+0001 000002 04FC  
+0002 000004 0000  
+0003 000006 8048  
+0004 008048 3E7C
```

This list of numbers will be explained in detail later in this chapter in "The State Listing."

How Do I Configure the Logic Analyzer?

In order to make this state measurement, you must configure the logic analyzer as a state analyzer. By following these steps you will configure Analyzer 1 as the state analyzer.

If you are in the System Configuration menu you are in the right place to get started and you can start with step 2; otherwise, start with step 1.

1. Using the field in the upper left corner of the display, get the System Configuration menu on screen.
 - a. Place the cursor on the field in the upper left corner of the display and press **SELECT**.
 - b. Place the cursor on **System** and press **SELECT**
2. In the System Configuration menu, change the Analyzer 1 type to **State**. If Analyzer 1 is already a state analyzer, go on to step 3.
 - a. Place the cursor on the **Type:** _____ and press **SELECT**
 - b. Place the cursor on **State** and press **SELECT**.

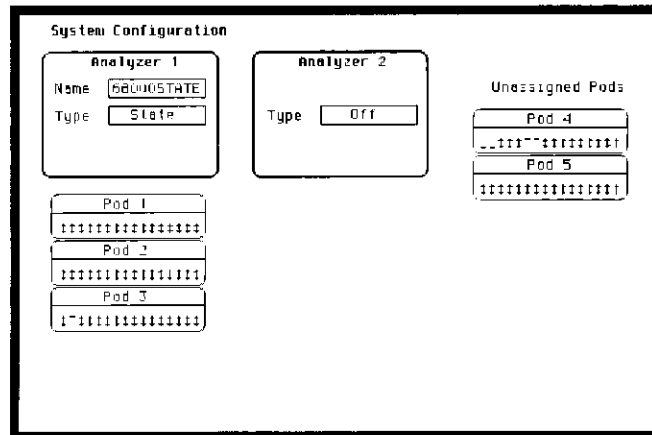

3. Name Analyzer 1 **68000STATE** (optional)

- a. Place the cursor on the **Name:** _____ field of Analyzer 1 and press **SELECT**.
- b. With the Alpha Entry pop-up, change the name to **68000STATE** (see "Alpha Entry Pop-up Menu" in chapter 4 if you need a reminder).

4. Assign pods 1, 2, and 3 to the state analyzer.

- a. Place the cursor on the **Pod 1** field and press **SELECT**.
- b. In the Pod 1 pop-up, place the cursor on **Analyzer 1** and press **SELECT**.
- c. Repeat steps a and b for pods 2 and 3.

Connecting the Probes

At this point, if you had a target system with a 68000 microprocessor, you would connect the logic analyzer to your system. Since you will be assigning labels **ADDR** and **DATA**, you hook the probes to your system accordingly.

- Pod 1 probes 0 through 15 to the data bus lines D0 through D15.
- Pod 2 probes 0 through 15 to the address bus lines A0 through A15
- Pod 3 probes 0 through 7 to the address bus lines A16 through A23.
- Pod 1, CLK (J clock) to the address strobe (LAS).

Activity Indicators

When the logic analyzer is connected and your target system is running, you will see \uparrow in the Pod 1, 2, and 3 fields of the System Configuration menu. This indicates which signal lines are transitioning.

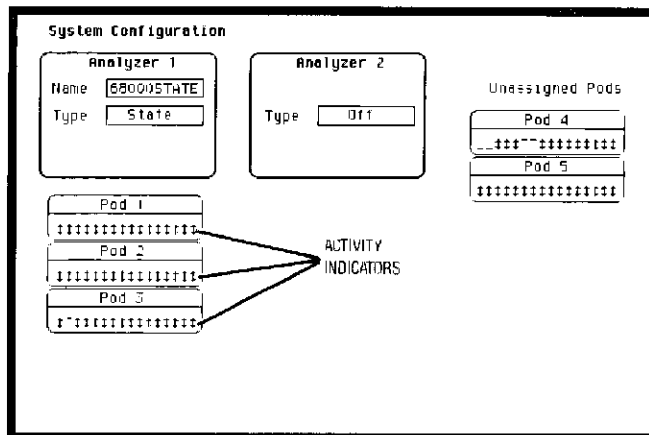

Configuring the State Analyzer

Now that you have configured the system, you are ready to configure the state analyzer. You will be:

- Creating two names (labels) for the input signals
- Assigning the channels connected to the input signals
- Specifying the State (J) clock
- Specifying a trigger condition

1. Display the STATE FORMAT SPECIFICATION menu.
 - a. Press the **FORMAT** key on the front panel.
2. Name two labels, one **ADDR** and one **DATA**.
 - a. Place the cursor on the top field in the label column and press **SELECT**.
 - b. Place the cursor on **Modify label** and press **SELECT**

68001STATE] - STATE FORMAT SPECIFICATION Specify Symbols

CLOCK
J1

| | POD 3 | POD 2 | POD 1 |
|------------|---------|----------|---------|
| | TTL | TTL | TTL |
| | Clock | Clock | Clock |
| Activity : | ***** | ***** | ***** |
| Label Pol | 15 07 0 | 15 07 11 | 15 07 0 |
| ADDR | ***** | ***** | ***** |
| DATA | ***** | ***** | ***** |
| -Off- | | | |
| -Off- | | | |
| -Off- | | | |
| -Off- | | | |
| -Off- | | | |
| -Off- | | | |
| -Off- | | | |
| -Off- | | | |

- c. With the Alpha Entry pop-up, change the name of the label to **ADDR** (see "Alpha Entry Pop-up Menu" in chapter 4 if you need a reminder).
- d. Name the second label **DATA** by repeating steps a through c.

3 Assign Pod 1 bits 0 through 15 to the label **DATA**

- a. Place the cursor on the bit assignment field below Pod 1 and to the right of **DATA** and press **SELECT**.
- b. Any combination of bits may already be assigned to this pod; however, you will want all 16 bits assigned to the **DATA** label. The easiest way to assign is to press the **CLEAR ENTRY** key to un-assign any assigned bits before you start.
- c. Place the cursor on the period under the 15 in the bit assignment pop-up and press **SELECT**. This will place an asterisk in the pop-up for bit 15, indicating Pod 1 bit 15 is now assigned to the **DATA** label. Repeat this procedure until all 16 bits have an asterisk under each bit number. Place the cursor on **Done** and press **SELECT** to close the pop-up.
- d. Repeat step c for Pod 2 and the **ADDR** label to assign all 16 bits.
- e. Repeat step c except you will assign the lower eight bits (0 - 7) of Pod 3 to the **ADDR** label.

Specifying the J Clock

If you remember from "What's a State Analyzer" in *Feeling Comfortable With Logic Analyzers*, the state analyzer samples the data under the control of an external clock, which is "synchronous" with your circuit under test. Therefore, you must specify which clock probe you will use for your measurement. In this exercise, you will use the J clock, which is accessible through pod 1.

1. Select the STATE FORMAT SPECIFICATION menu by pressing the **FORMAT** key.
2. Set the J Clock to sample on a negative-going edge.
 - a. Place the cursor on the **CLOCK** field and press **SELECT**.
 - b. Place the cursor on the box just to the right of **J** in the pop-up (labeled **OFF**) and press **SELECT**.
 - c. Place the cursor on **↓** and press **SELECT**.
 - d. Place the cursor on **Done** and press **SELECT**.

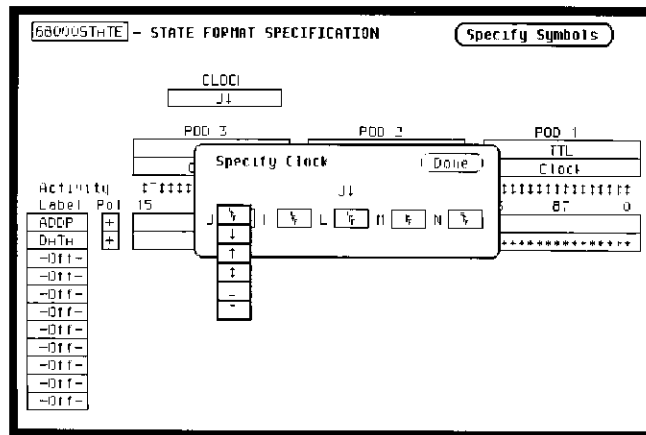

Specifying a Trigger Condition

To capture the data and place the data of interest in the center of the display of the STATE LISTING menu, you need to tell the state analyzer when to trigger. Since the first event of interest is address 0000, you need to tell the state analyzer to trigger when it detects address 0000 on the address bus.

1. Select the STATE TRACE SPECIFICATION menu by pressing the TRACE key.
2. Set the trigger so that the state analyzer triggers on address 0000.
 - a. Place the cursor on the 1 in the Sequence Levels field of the menu and press SELECT.

The screenshot shows the STATE TRACE SPECIFICATION menu. The title is "0000STATE - STATE TRACE SPECIFICATION". The "Trace mode" is set to "Single". On the left, there are two sequence levels, with "1" selected. The "Armed by" field is set to "Pun". The "Done" button is visible. The "Sequence Level 1" configuration is shown, including "Insert Level" and "Delete Level" buttons. The "While storing" field is set to "anystate". The "Trigger on" field is set to "a" and "1" times. The "Label" section shows a table of base and qualifier options.

| Label | Base | He | He |
|-------|--------|------|----|
| a | 000000 | 0000 | |
| b | 00000 | 0000 | |
| c | 00000 | 0000 | |
| d | 00000 | 0000 | |

- b. Place the cursor on the **anystate** field to the right of the **Trigger on** field and press **SELECT**. Another pop-up appears showing you a list of "trigger on" options. Options a through h are qualifiers. You can assign them a pattern for the trigger specification.

- c. Place the cursor on the **a** option and press **SELECT**
- d. Place the cursor on **Done** in the **Sequence Levels** pop-up and press **SELECT**.
- e. Place the cursor on the field to the right of the **a** under the label **ADDR** and press **SELECT**.
- f. With the keypad, press 0 (zero) until there are all zeros in the **Specify Pattern:** pop-up and then press **SELECT**.

Your trigger specification now states: "While storing anystate, trigger on "a" once and then store anystate."

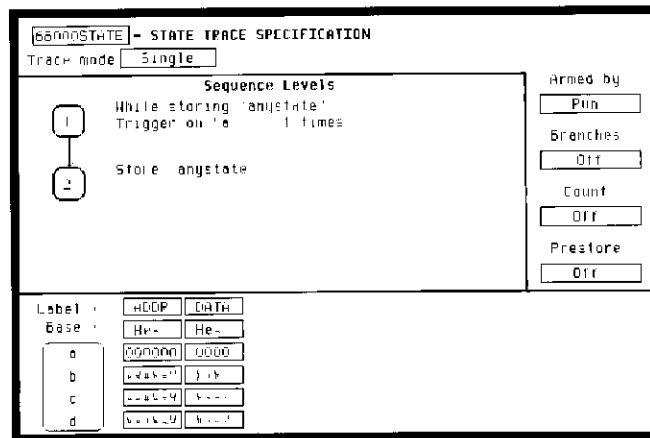

When the state analyzer is connected to your circuit and is acquiring data, it continuously stores until it sees 0000 on the address bus, then it will store anystate until the analyzer memory is filled.

Acquiring the Data

Since you want to capture the data when the microprocessor sends address 0000 on the bus after power-up, you press the RUN key to arm the state analyzer and then force a reset of your circuit. When the reset cycle ends, the microprocessor should send address 0000, trigger the state analyzer and switch the display to the STATE LISTING menu.

We'll assume this is what happens in this example, since the odds that the microprocessor won't send address 0000 are very low.

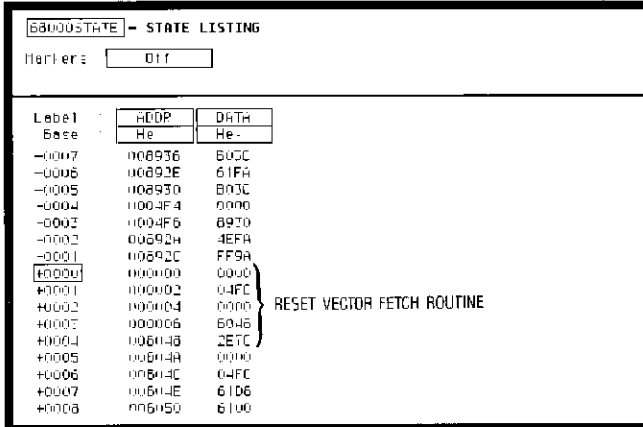

58000STATE - STATE LISTING

Filters:

| Label | ADDR | DATA |
|-------|--------|------|
| Base | Hex | Hex |
| -0007 | 008936 | 60CC |
| -0006 | 00892E | 61FA |
| -0005 | 008930 | B03C |
| -0004 | 0004F4 | 0000 |
| -0003 | 0004F6 | 8930 |
| -0002 | 006924 | 4EFA |
| -0001 | 00692C | FF9A |
| 0000 | 000000 | 0000 |
| +0001 | 000002 | 04FC |
| +0002 | 000004 | 0000 |
| +0003 | 000006 | 504B |
| +0004 | 00604B | 2E7C |
| +0005 | 00604A | 0000 |
| +0006 | 00604C | 04FC |
| +0007 | 00604E | 6106 |
| +0008 | 006050 | 6100 |

} RESET VECTOR FETCH ROUTINE

Now is the time to load the state measurement demo file from the disc if you wish. The file name is **STATEDEMO**. Follow the procedure in Appendix B to load the file

The State Listing

The state listing displays three columns of numbers as shown:

68000STATE - STATE LISTING
Markers: Off

| Label Base | ADDR Hex | DATA Hex |
|------------|----------|----------|
| -0007 | 006976 | B07C |
| -0006 | 00692E | 61FA |
| -0005 | 006930 | B07C |
| -0004 | 0004F4 | 0000 |
| -0003 | 0004F6 | 0970 |
| -0002 | 00692A | 4EFA |
| -0001 | 00692C | FF9A |
| +0000 | 000000 | 0000 |
| +0001 | 000002 | 04FC |
| +0002 | 000004 | 0000 |
| +0003 | 000006 | 004B |
| +0004 | 000046 | 2E7C |
| +0005 | 00804A | 0000 |
| +0006 | 00804C | 04FC |
| +0007 | 00804E | 61DB |
| +0008 | 008050 | 6106 |

STATE LOCATIONS

The first column of numbers are the state line number locations as they relate to the trigger point. The trigger state is on line +0000 in the vertical center of the list area. The negative numbers indicate states occurring before the trigger and the positive numbers indicate states occurring after the trigger.

The second column of numbers are the states (listed in HEX) the state analyzer sees on the address bus. This column is labeled **ADDR**.

The third column of numbers are the states (listed in HEX) the state analyzer sees on the data bus. This column is labeled **DATA**.

Finding the Answer

Your answer is now found in the listing of states +0000 through +0004.

The 68000 always reads address locations 0, 2, 4, and 6 to find the stack pointer location and memory location for the instruction it fetches after power-up. The 68000 uses two words for each of the locations that it is looking for, a high word and a low word. When the software designer programs the ROM, he must put the stack pointer location at address locations 0 and 2. 0 is the high word location and 2 is the low word location. Similarly, the high word of the instruction fetch location must be in address location 4 and the low word in location 6.

Since the software design calls for the reset vector to

1. Set the stack pointer to 04FC
2. Read memory address location 8048 for its first instruction fetch. You are interested in what is on both the address bus and the data bus in states 0 through 3. You look at the following listing and see that states 0 and 1 do contain address locations 0 and 2 under the ADDR label, indicating the microprocessor did look at the correct locations for the stack pointer data. You also see that the data contained in these ROM locations are 0000 and 04FC, which are correct.

You then look at states 2 and 3. You see that the next two address locations are 4 and 6, which is correct, and the data found at these locations is 0000 and 8048, which is also correct.

```
+0000 000000 0000
+0001 000002 04FC
+0002 000004 0000
+0003 000006 8048
+0004 008048 3E7C
```

So far you have verified that the microprocessor has correctly performed the reset vector search. The next thing you must verify is whether the microprocessor addresses the correct location in ROM that it was instructed to address in state 4 and whether the data is correct in this ROM location. From the listing you see that the address in state 4 is 008048, which is correct, but the instruction found in this location is 2E7C, which is not correct. You have found your problem: incorrect data stored in ROM for the microprocessor's first instruction.

- +0000 000000 0000 (high word of stack pointer location)
- +0001 000002 04FC (low word of stack pointer location)
- +0002 000004 0000 (high word of instruction fetch location)
- +0003 000006 8048 (low word of instruction fetch location)
- +0004 008048 2E7C (first microprocessor instruction)

660005STATE - STATE LISTING

Markers Off

| Label | ADDR | DATA |
|-------|--------|-----------------------|
| Base | Hex | Hex |
| -0007 | 008936 | 803C |
| -0006 | 00892E | 61FA |
| -0005 | 008930 | 803C |
| -0004 | 0004F4 | 0000 |
| -0003 | 0004F6 | 8970 |
| -0002 | 00892A | 4EFA |
| -0001 | 00892C | FF9H |
| +0000 | 000000 | 0000 |
| +0001 | 000002 | 04FC |
| +0002 | 000004 | 0000 |
| +0003 | 000006 | 8048 |
| +0004 | 008048 | 2E7C ← INCORRECT DATA |
| +0005 | 00804A | 0000 |
| +0006 | 00804C | 04FC |
| +0007 | 00804E | 6106 |
| +0008 | 008050 | 6100 |

Summary

You have just learned how to make a simple state measurement with the HP 1650A Logic Analyzer. You have:

- specified a state analyzer
- learned which probes to connect
- assigned pods 1, 2, and 3
- assigned labels
- assigned bits
- specified the J clock
- specified a trigger condition
- acquired the data
- interpreted the state listing

You have seen how easy it is to use the state analyzer to capture the data on the address and data buses. You can use this same technique to capture and display related data on the microprocessor status, control, and various strobe lines. You are not limited to using this technique on microprocessors. You can use this technique any time you need to capture data on multiple lines and need to sample the data relative to a system clock.

The next chapter teaches you how to use the logic analyzer as an interactive timing and state analyzer. You will see a simple measurement that shows you both timing waveforms and state listings and how they are correlated.

If you have an HP 1651A, you do not have enough channels to simultaneously capture all the data for a 68000. But, since you probably aren't working with 16-bit microprocessors, this example is still valuable because it shows you how to make the same kind of measurement on an eight-bit microprocessor

7

Using the Timing/State Analyzer

Introduction

In this chapter you will learn how to use the timing and state analyzers interactively by setting up the logic analyzer to make a simple measurement. We give you the measurement results as actually measured by the logic analyzer, since you may not have the same circuit available.

The exercise in this chapter is organized differently than the exercises in the two previous chapters. Since you have already set up both the timing and state analyzers, you should be ready to set them up for this measurement by looking at the menu pictures.

Any new set-ups in this exercise will be explained in task format steps like the previous chapters.

How you use the steps depends on how much you remember from chapters 1 through 4. If you can set up each menu by just looking at the menu picture, go ahead and do so. If you need a reminder of what steps to perform, follow the numbered steps. If you still need more information about "how," use the lettered steps.

When you have finished configuring the logic analyzer for this exercise, you can load a file from the operating system disc. This file configures the logic analyzer the same way it is configured for this exercise. It also loads the same data acquired for this exercise so you can see what it looks like on screen.

In order to learn how to configure the logic analyzer, we recommend that you follow the exercise to "Acquiring the Data" before loading the file from the disc.

You can also compare your configuration with the one on the disc by printing it (if you have a printer) or making notes before you load the file.

Problem Solving with the Timing/ State Analyzer

In this example assume you have designed a microprocessor-controlled circuit. You have completed the hardware, and the software designer has completed the software and programmed the ROM (read-only memory). When you turn your circuit on for the first time, your circuit doesn't work properly. You have checked the power supply voltages and the system clock, and they are working properly.

Since the circuit has never worked before, you and the software engineer aren't sure if it is a hardware or software problem. You need to do some testing to find a solution.

You also notice the circuit fails intermittently. More specifically, it only fails when the microprocessor attempts to address a routine that starts at address 8930.

What Am I Going to Measure?

To see what might be causing the failure, you decide to start where the microprocessor goes to the routine that starts at address 8930.

The first thing you check is whether the microprocessor actually addresses address 8930. The next thing you check is whether the code is correct in all the steps in this routine.

Your measurement, then, requires verification of:

- whether the microprocessor addresses location 8930
- whether all the addresses within the routine are correct
- whether all the data at the addresses in the routine are correct

If the routine is correct, the state listing will display:

```
+0000 008930 B03C
+0001 008932 61FA
+0002 008934 67F8
+0003 008936 B03C
+0004 00892E 61FA
```

How Do I Configure the Logic Analyzer?

In order to make this measurement, you must configure the logic analyzer as a state analyzer because you want to trigger on a specific state (8930). You also want to verify that the addresses and data are correct in the states of this routine.

Configure the logic analyzer so that Analyzer 1 is a state analyzer as shown:

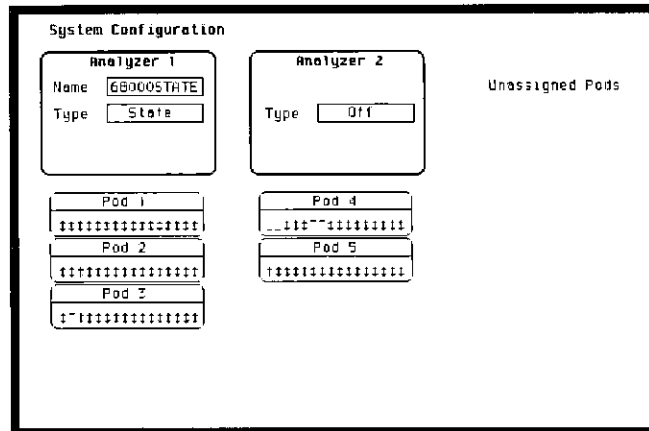

Configuring the State Analyzer

Now that you have configured the system, you are ready to configure the state analyzer.

Configure the STATE FORMAT SPECIFICATION menu as shown:

63000STATE - STATE FORMAT SPECIFICATION Specify Symbols

CLOCK
JI

POD 3: TTL, Clock
POD 2: TTL, Clock
POD 1: TTL, Clock

| Activity | Label | Pol | IS | 87 | 0 |
|----------|-------|-----|----|----|---|
| HDDR | + | | | | |
| DATA | + | | | | |
| -Off- | | | | | |
| -Off- | | | | | |
| -Off- | | | | | |
| -Off- | | | | | |
| -Off- | | | | | |
| -Off- | | | | | |
| -Off- | | | | | |
| -Off- | | | | | |

Configure the STATE TRACE SPECIFICATION menu as shown:

63000STATE - STATE TRACE SPECIFICATION

Trace mode: Single

Sequence Levels

- 1: While storing 'anystate' (Trigger on 0 1 times)
- 2: Store anystate

Armed by: Run
Branches: Off
Count: Time
Prestore: Off

| Label | HDDR | DATA |
|-------|------|------|
| a | Hex | Hex |
| b | Hex | Hex |
| c | Hex | Hex |
| d | Hex | Hex |

Connecting the Probes

At this point, if you had a target system with a 68000 microprocessor, you would connect the logic analyzer to your system. Since you will be assigning labels **ADDR** and **DATA**, you will hook the probes to your system accordingly.

- Pod 1 probes 0 through 15 to the data bus lines D0 through D15
- Pod 2 probes 0 through 15 to the address bus lines A0 through A15
- Pod 3 probes 0 through 7 to the address bus lines A16 through A23
- Pod 1, **CLK** (J clock) to the address strobe (LAS)

Acquiring the Data

Since you want to capture the data when the microprocessor sends address 8930 on the bus, you press the **RUN** key to arm the state analyzer. If the microprocessor sends address 8930, it will trigger the state analyzer and switch the display to the **STATE LISTING** menu

We'll assume this is what happens in this example.

Finding the Problem

You look at this listing to see what the data is in states +0000 through +0004. You know your routine is five states long.

The 68000 does address location 8930, so you know that the routine is addressed. Now you need to compare the state listing with the following correct addresses and data:

```
+0000 008930 B03C
+0001 008932 61FA
+0002 008934 67F8
+0003 008936 B03C
+0004 00892E 61FA
```

As you compare the state listing (shown below) with the above data, you notice the data at address 8932 is incorrect. Now you need to find out why.

| Label | ADDR | DATA |
|-------|--------|-----------------------|
| Base | Hex | Hex |
| -0007 | 0068CA | 00FF |
| -0006 | 0068CC | 6730 |
| -0005 | 0068CE | 48E7 |
| -0004 | 0068FE | 4E75 |
| -0003 | 006900 | 3000 |
| -0002 | 0002B4 | 0000 |
| -0001 | 0002B6 | 8970 |
| +0000 | 006930 | B03C |
| +0001 | 006932 | 00FF ← INCORRECT DATA |
| +0002 | 006934 | 67F8 |
| +0003 | 006936 | B03C |
| +0004 | 00692E | 61FA |
| +0005 | 006930 | B03C |
| +0006 | 0002B4 | 0000 |
| +0007 | 0002B6 | 8970 |
| +0008 | 00692A | 4EFA |

Your first assumption is that incorrect data is stored to this memory location. Assume this routine is in ROM since it is part of the operating system for your circuit. Since the ROM is programmed by the software designer, you have the software designer verify whether or not the data at address 8932 is correct. The software designer tells you that the data is correct. Now what do you do?

Now it's time to look at the hardware to see if it is causing incorrect data when the microprocessor reads this memory address. You decide you want to see what is happening on the address and data buses during this routine in the time domain.

In order to see the time domain, you need the timing analyzer.

What Additional Measurements Must I Make?

Since the problem exists during the routine that starts at address 8930, you decide you want to see the timing waveforms on the address and data bus when the routine is running. You also want to see the control signals that control the read cycle. You will then compare the waveforms with the timing diagrams in the 68000 data book.

Your measurement, then, requires verification of:

- correct timing of the control signals
- stable addresses and data during the memory read

The control signals you must check are:

- system clock
- address strobe (AS)
- lower and upper data strobes (LDS and UDS)
- data transfer acknowledge (DTACK)
- read/write (R/W)

How Do I Re-configure the Logic Analyzer?

In order to make this measurement, you must re-configure the logic analyzer so Analyzer 2 is a timing analyzer. You leave Analyzer 1 as a state analyzer since you will use the state analyzer to trigger on address 8930.

Configure the logic analyzer so Analyzer 2 is a timing analyzer as shown:

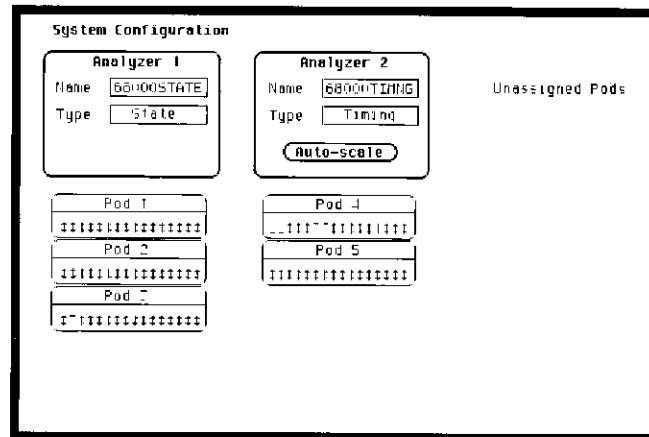

Connecting the Timing Analyzer Probes

At this point you would connect the probes of pods 4 and 5 as follows:

- Pod 4 bit 0 to address strobe (AS)
- Pod 4 bit 1 to the system clock
- Pod 4 bit 2 to low data strobe (LDS)
- Pod 4 bit 3 to upper data strobe (UDS)
- Pod 4 bit 4 to the read/write (R/W)
- Pod 4 bit 5 to data transfer acknowledge (DTACK)
- Pod 5 bits 0 through 7 to address lines A0 through A7
- Pod 5 bits 8 through 15 to data lines D0 through D7

Using the Timing/State Analyzer
7-8

Configuring the Timing Analyzer

Now that you have configured the system, you are ready to configure the timing analyzer.

Configure the TIMING FORMAT SPECIFICATION menu as shown:

| | | POD 5 | | | POD 4 | | |
|----------|-------|-------|----|---|------------------|----|---|
| | | TTL | | | TTL | | |
| Activity | | ----- | | | ..ttt---ttt----- | | |
| Label | Pol | 15 | 07 | 0 | 15 | 07 | 0 |
| CLOCK | + | | | | | * | |
| AS | + | | | | | * | |
| LDS | + | | | | | * | |
| UDS | + | | | | | * | |
| DTACK | + | | | | | * | |
| P/H | + | | | | | * | |
| ADDR | + | | | | | * | |
| DATA | + | ***** | | | ***** | | |
| | -Off- | | | | | | |
| | -Off- | | | | | | |
| | -Off- | | | | | | |
| | -Off- | | | | | | |
| | -Off- | | | | | | |
| | -Off- | | | | | | |

Configure the TIMING TRACE SPECIFICATION as shown:

66000TIMING - TIMING TRACE SPECIFICATION

Trace mode:

Armed by: Acquisition mode:

Label:

Base:

Find Pattern:

present for:

Then find Edge:

Setting the Timing Analyzer Trigger

Your timing measurement requires the timing analyzer to display the timing waveforms present on the buses when the routine is running. Since you triggered the state analyzer on address 8930, you want to trigger the timing analyzer so the timing waveforms can be time correlated with the state listing.

To set up the logic analyzer so that the state analyzer triggers the timing analyzer, perform these steps:

1. Display the **TIMING TRACE SPECIFICATION** menu.
2. Place the cursor on the **Armed by** _____ field and press **SELECT**
3. Place the cursor on the **68000STATE** option in the pop-up and press **SELECT**.

Your timing trace specification should match the menu shown:

STATE ANALYZER
ARMS TIMING
ANALYZER

68000TIMING - TIMING TRACE SPECIFICATION

Trace mode Acquisition mode

Armed by

Label:

Base:

Find Pattern:

present for ns

Then find Edge:

Time Correlating the Data

In order to time correlate the data, the logic analyzer must store the timing relationships between states. Since the timing analyzer samples asynchronously and the state analyzer samples synchronously, the logic analyzer must use the stored timing relationship of the data to reconstruct a time correlated display.

To set up the logic analyzer to keep track of these timing relationships, turn on a counter in the **STATE TRACE SPECIFICATION** menu. The following steps show you how:

1. Display the **STATE TRACE SPECIFICATION** menu
2. Place the cursor in the field just below **Count** on the right side of the display and press **SELECT**.
3. Place the cursor on the **Time** option and press **SELECT**. The counter will now be able to keep track of time for the time correlation.

The screenshot shows the 'STATE TRACE SPECIFICATION' menu for '66000STATE'. The 'Trace mode' is set to 'Single'. The 'Sequence Levels' section contains two levels: Level 1 is 'While storing "anystate" Trigger on "a" 1 times', and Level 2 is 'Store "anystate"'. On the right, there are control buttons for 'Armed by' (Run), 'Branch' (Off), 'Count' (Time), and 'Prestore' (Off). At the bottom, there is a table for 'Label' and 'Base' with columns for 'ADDRESS' and 'DATA'.

| Label | ADDRESS | DATA |
|-------|---------|------|
| a | 000930 | xxxx |
| b | xxxxxx | xxxx |
| c | xxxxxx | xxxx |
| d | xxxxxx | xxxx |

Re-acquiring the Data

After you connect the probes of pods 4 and 5 to your circuit, all you have to do is press **RUN**. When the logic analyzer acquires the data, it switches the display to the **STATE LISTING** menu unless you switched one of the other menus to the timing analyzer after reconfiguring the **STATE TRACE** menu. Regardless of which menu is displayed, change the display to the **Mixed mode**.

Now is the time to load the mixed measurement demo file from the disc if you wish. The file name is **MIXEDDEMO**. Follow the procedure in Appendix B to load the file.

Mixed Mode Display

The **Mixed mode** display shows you both the **STATE LISTING** and **TIMING WAVEFORMS** menus simultaneously. To change the display to the **Mixed mode**:

- 1 Place the cursor on the field in the upper left corner of the display and press **SELECT**.
- 2 Place the cursor on **Mixed mode** and press **SELECT**.

You will now see the mixed display as shown.

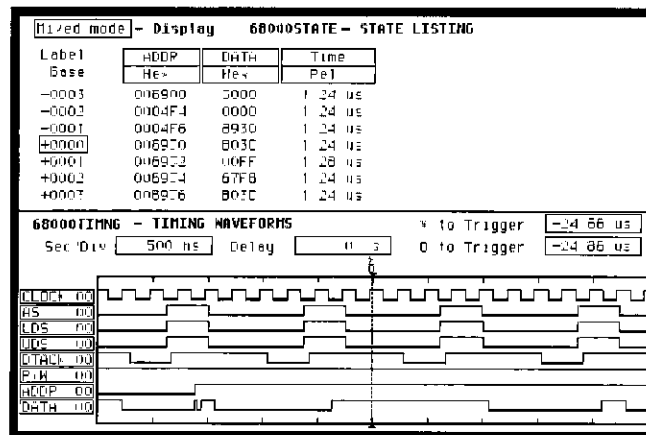

Interpreting the Display

In the **Mixed mode** display the state listing is in the top half of the screen and the timing waveforms are in the lower half. The important thing to remember is that you time correlated this display so you could see what is happening in the time domain during the faulty routine.

Notice that the trigger point in both parts of the display is the same as it was when the displays were separate. The trigger in the state listing is in the box containing +0000 and the trigger of the timing waveform is the vertical dotted line.

As you look at the mixed display, you notice nothing wrong except the data at address 8932 is incorrect. However, you are seeing only one bit each of the address and the data. To see all the data and addresses in the timing waveform part of the display, you must overlap them.

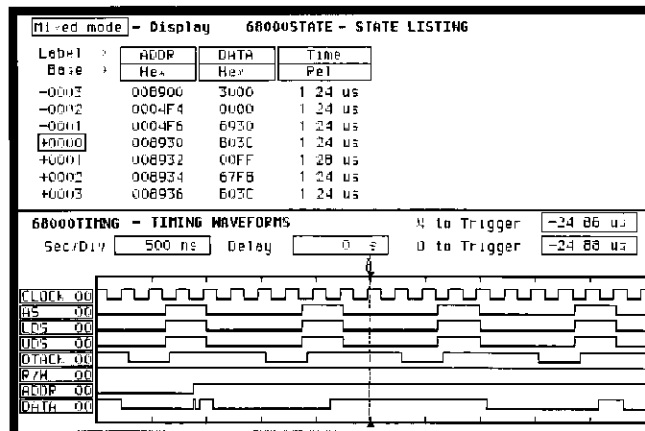

Overlapping Timing Waveforms

Since you see nothing wrong with the timing waveforms so far, you think unstable data may be on the data lines during the read cycle. In order to see unstable data, you must be able to see all the data lines during the read and look for transitions. Overlapping the waveforms allows you to do this. To overlap waveforms, follow these steps:

1. Place the cursor on the **00** of the **ADDR 00** label and press **SELECT**. The following pop-up opens in which you specify the bit or bits of the address bus you want to overlap.
2. Rotate the **KNOB** until **all** is displayed and press **SELECT**. All the address bits will be overlapped on one line.
3. Repeat step 2 except overlap the data bits.

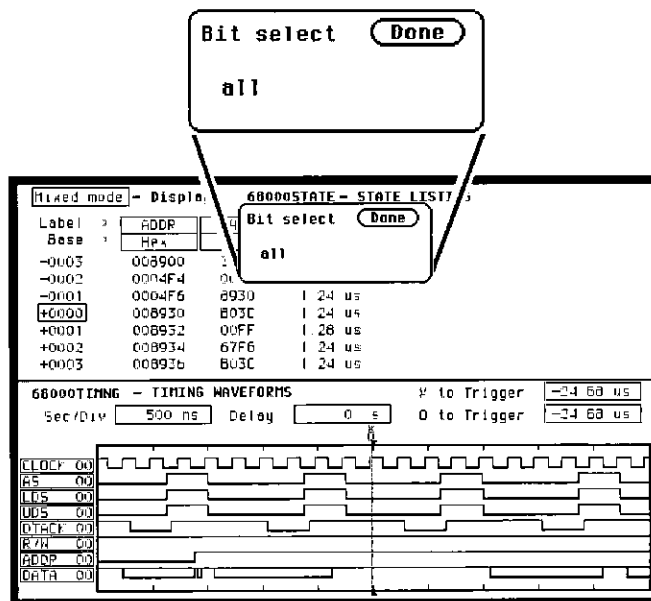

Finding the Answer

As you look at the overlapping waveforms, you notice there are transitions on the data lines during the read cycle, indicating the data is unstable. You have found the probable cause of the problem in this routine. Additional troubleshooting of the hardware will identify the actual cause.

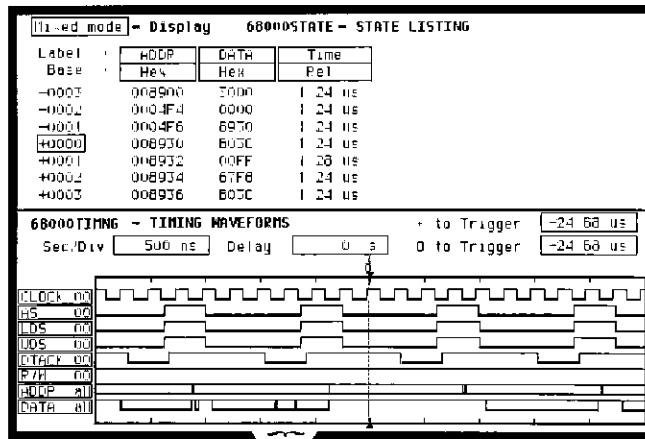

Summary

You have just learned how to use the timing and state analyzers interactively to find a problem that first appeared to be a software problem, but actually was a hardware problem.

You have learned to:

- trigger one analyzer with the other
- time correlate measurement data
- interpret the Mixed mode display
- overlap timing waveforms

If you have an HP 1651A, you do not have enough channels to simultaneously capture all the data for a 68000. But, since you probably aren't working with 16-bit microprocessors, this exercise is still valuable because it shows you how to make the same kind of measurement on an eight-bit microprocessor.

8

Making Hardcopy Prints

Introduction

The HP 1650A/51A Logic Analyzers allow you to print the configurations, waveforms, and listings. Whenever your printer is connected to your logic analyzer and you instruct it to do so, it will print what is currently displayed on screen.

This chapter shows you how to set up the logic analyzer's RS-232C interface for printers. If you have a Hewlett-Packard ThinkJet, QuietJet, or ThinkJet series printer, the RS-232C interface is already set up for you. If you have another kind of printer, refer to your printer manual for its interface requirements and change your logic analyzer's interface configuration as instructed.

Hooking Up Your Printer

If your printer is already connected to the logic analyzer, skip to "Setting RS-232C for HP Printers" on the next page. If not, hooking up your printer is just a matter of having the correct RS-232C interface cable for your printer and logic analyzer. Refer to the *Setting Up The Logic Analyzer Guide* you received with your logic analyzer.

Setting RS-232C for HP Printers

All you have to do to set the interface for any of the previously listed Hewlett-Packard series printers is to set the printer type in the **RS-232C Configuration** submenu.

To set the printer type, follow these steps.

- 1 Display the **I/O** menu by pressing the **I/O** key.
- 2 Place the cursor on **RS-232C Configuration** and press **SELECT**

You will see the following submenu:

The screenshot shows a terminal window titled "RS-232C CONFIGURATION" with a "Done" button in the top right corner. The settings are as follows:

| | |
|-------------|----------|
| Protocol | XON/-OFF |
| Data Bits | 8 |
| Stop Bits | 1 |
| Parity | None |
| Baud rate | 9600 |
| Printer | ThinkJet |
| Paper width | 6.5" |

3. Place the cursor in the **Printer : _____** field and press **SELECT**. The pop-up opens showing you the printer choices.
4. Place the cursor on the printer series type and press **SELECT**.
5. Place the cursor on **Done** and press **SELECT**. The logic analyzer will display the menu that was displayed when you selected the **I/O** menu.

Setting RS-232C for Your Non-HP Printer

The following attributes of the RS-232C interface must be set to the correct configuration for your printer:

- Protocol
- number of data bits
- number of stop bits
- parity type
- Baud rate
- paper width

You can set all of these attributes for your printer by following this procedure

1. Press the **I/O** key to display the **I/O** menu.
2. Place the cursor on **RS-232C Configuration** and press **SELECT**.
3. Place the cursor on the attribute and press **SELECT**.
4. When the pop-up is open, place the cursor on the option your printer requires and press **SELECT**. The pop-up closes, placing your selection in the box. Repeat this step for all attributes that you need to change.
5. Place the cursor on **Done** and press **SELECT**. The logic analyzer will display the menu that was displayed when you selected the **I/O** menu.

Starting the Printout

When you are ready to print, you will need to know whether there is more data than is displayed on screen. In cases where data is off screen (i.e., format specifications with all pods assigned to a single analyzer), you need to decide whether you want all the data or just the data that is on screen.

If you want just what is on screen, start the printout with the **Print Screen** option. If you want all the data, use the **Print All** option. Both options are in the I/O menu.

Once you decide which option to use, start the printout by placing the cursor on the print option (screen or all) and pressing **SELECT**.

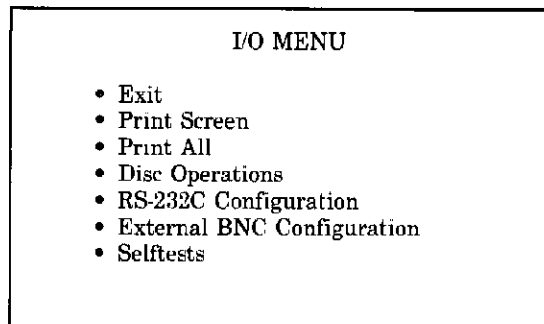

Print Screen The **Print Screen** option prints only what is displayed on screen at the time you initiate the printout. In the Print Screen mode, the printer uses its graphics capabilities so the printout will look just like the logic analyzer screen with only one exception: the cursor will not print.

Print All The **Print All** option prints not only what is displayed on screen, but also what is off screen at the time you initiate the printout. In the **Print All** mode, the printout will be made in the text mode with only one exception: a timing waveform display will be printed in the graphics mode because it has no off-screen data.

Use this option when you want to print all the data in menus like:

- **TIMING** and **STATE FORMAT SPECIFICATIONS**
- **TIMING** and **STATE TRACE SPECIFICATIONS**
- **STATE LISTING**

What Happens during a Printout?

When you press select to start the printout, the I/O menu pop-up disappears, then approximately seven seconds later an advisory **PRINT in progress** appears in the top center of the display. While the data is transferred to the printer, the logic analyzer's keyboard deactivates. When the logic analyzer has completed the data transfer to the printer, the advisory disappears and the keyboard reactivates.

Don't worry! The **PRINT in progress** advisory won't appear in your printout; that's why it is delayed when you start the printout.

Summary

Now that you have configured the RS-232C interface for your printer, you can make hardcopy printouts of anything that the logic analyzer displays. This is a valuable feature when you need to keep records of configurations and measurements.

Making Hardcopy Prints
8-6

9

What's Next?

Now that you are familiar with the logic analyzer, you may want to try some of the basic measurements discussed in this book on your target system. Refer to the documentation for your microprocessor.

If you are comfortable with the basic measurements that you can perform with the HP 1650A/51A Logic Analyzers, you are ready for the *HP 1650A/51A Reference Manual*. This reference manual explains all the capabilities of both logic analyzers and their operation from the front panel. The reference manual also tells you how to operate both logic analyzers from a controller via the RS-232C interface.

A

Logic Analyzer Turn-on Check List

This appendix summarizes the steps you take to turn on the HP 1650A/51A logic analyzers. The details of the turn-on procedures are in the *Setting Up the Logic Analyzer* booklet.

1. Check the rear-panel line voltage indicator for the proper setting. Change the setting if necessary.
2. Make sure you have the proper 3-wire grounded AC power cable.
3. Make sure the rear-panel line switch is **Off**.
4. Connect the power cable to the rear-panel line connector and a properly grounded power receptacle.
5. Make sure the yellow shipping disc is removed from the disc drive.
6. Insert the operating system disc in the disc drive.
7. Turn the logic analyzer on with the rear-panel line switch.

When the logic analyzer completes its self-tests, it then loads the operating system from the disc. When the operating system has been completely loaded, the **System Configuration** menu will be displayed.

B

Loading Demo Files from the Disc

To load the demo files from the disc, follow these steps:

1. Press the **I/O** key on the front panel
2. Place the cursor on ***Disc Operations** and press **SELECT**.

The disc drive indicator light will come on telling you the logic analyzer is reading the disc. When the disc is read, the logic analyzer will show you the directory of files on the disc.

3. Press the up/down **ROLL** key to activate the roll function.
4. Rotate the **KNOB** to place your file selection in the center of the screen. The center of the screen has an arrow on each side of the display area pointing toward the center.

When your file selection is in the center, it will be displayed in bold type.

5. Press the up/down **ROLL** key again to deactivate the file selection function.

Note

*Check to see what is displayed in the field in the upper left of the menu. If **Load** is displayed, skip steps 6 and 7.*

6. Place the cursor in the field in the upper left of the menu and press **SELECT**.
- 7 Place the cursor on **Load** and press **SELECT**. The pop-up will close and place **Load** in this field.

Verify that your file selection is displayed in the box to the right of **Load from file**. If it is not, repeat step 4. If the correct file is displayed, continue to step 8.

8. Place the cursor on **Execute** and press **SELECT**.

The logic analyzer will load the file and display **Load operation complete**. You resume normal logic analyzer operation by selecting the menu key for the menu you want to see.



Free Manuals Download Website

<http://myh66.com>

<http://usermanuals.us>

<http://www.somanuals.com>

<http://www.4manuals.cc>

<http://www.manual-lib.com>

<http://www.404manual.com>

<http://www.luxmanual.com>

<http://aubethermostatmanual.com>

Golf course search by state

<http://golfingnear.com>

Email search by domain

<http://emailbydomain.com>

Auto manuals search

<http://auto.somanuals.com>

TV manuals search

<http://tv.somanuals.com>